



US00D371442S

United States Patent [19]

[11] Patent Number: Des. 371,442

Semyonova

[45] Date of Patent: **Jul. 2, 1996

[54] **MESSAGE TOOL**

[76] Inventor: **Galina Semyonova**, 340 E. 93rd St.
Apt 22D, New York, N.Y. 10128

[**] Term: **14 Years**

[21] Appl. No.: **31,962**

[22] Filed: **Dec. 9, 1994**

[52] U.S. Cl. **D24/214**

[58] Field of Search D24/214, 212,
D24/211; 601/134, 135, 136

[56] **References Cited**

U.S. PATENT DOCUMENTS

D. 211,549	6/1968	Christopher	D24/211
D. 272,649	2/1984	Bloch	D24/214 X
D. 277,983	3/1985	Kaminski	D24/214
D. 282,949	3/1986	Arve	D24/214
D. 285,116	8/1986	Hoff	D24/214
5,044,626	9/1991	Parker, Jr.	601/135 X

Primary Examiner—Stella Reid

Attorney, Agent, or Firm—Collard & Roe

[57] **CLAIM**

The ornamental design for a massage tool, as shown and described.

DESCRIPTION

FIG. 1 is a perspective view of a first embodiment of a

massage tool showing my new design;

FIG. 2 is a bottom view thereof;

FIG. 3 is a top plan view thereof;

FIG. 4 is a front side elevational view thereof; the left side, rear side and right side elevational views being identical;

FIG. 5 is a perspective view of a second embodiment of a massage tool;

FIG. 6 is a bottom view thereof;

FIG. 7 is a top plan view thereof;

FIG. 8 is a front side elevational view thereof; the left side, rear side and right side elevational views being identical;

FIG. 9 is a perspective view of a third embodiment of a massage tool;

FIG. 10 is a bottom view thereof;

FIG. 11 is a top plan view thereof;

FIG. 12 is a front side elevational view thereof; the left side, rear side and right side elevational views being identical;

FIG. 13 is a perspective view of a fourth embodiment of a massage tool;

FIG. 14 is a bottom view thereof;

FIG. 15 is a top plan view thereof; and,

FIG. 16 is a front side elevational view thereof; the left side, rear side and right side elevational views being identical.

1 Claim, 4 Drawing Sheets

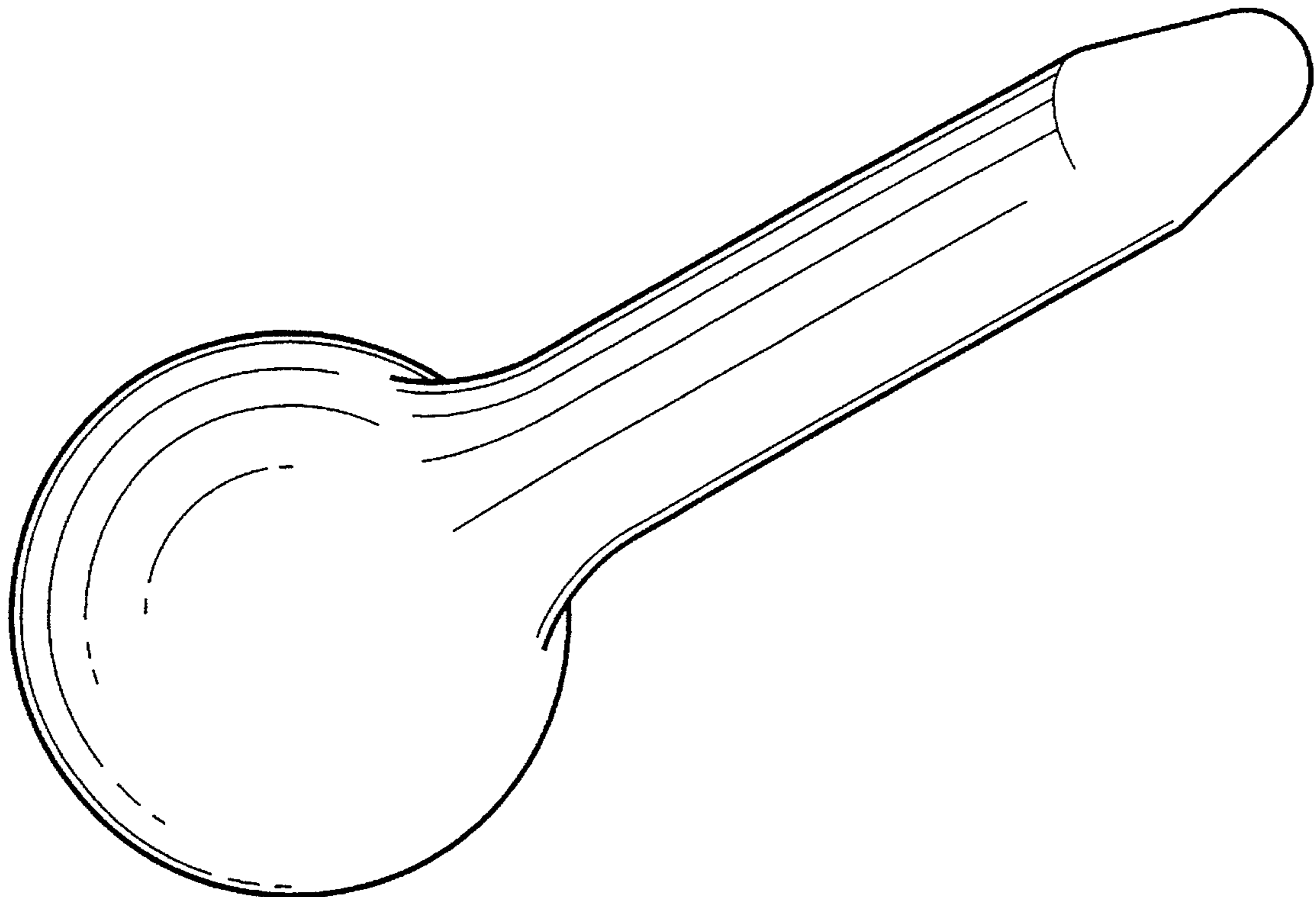

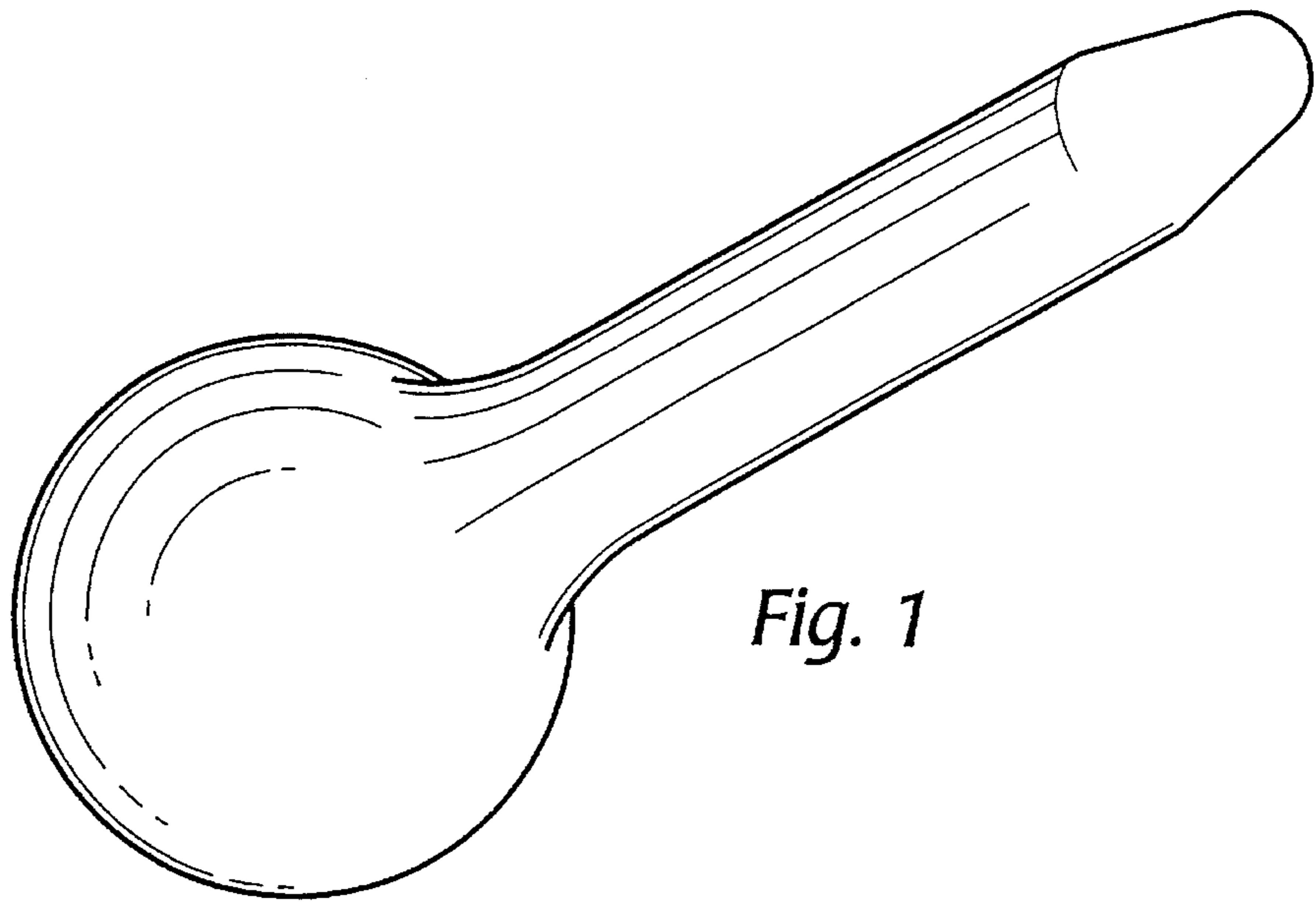

Fig. 1

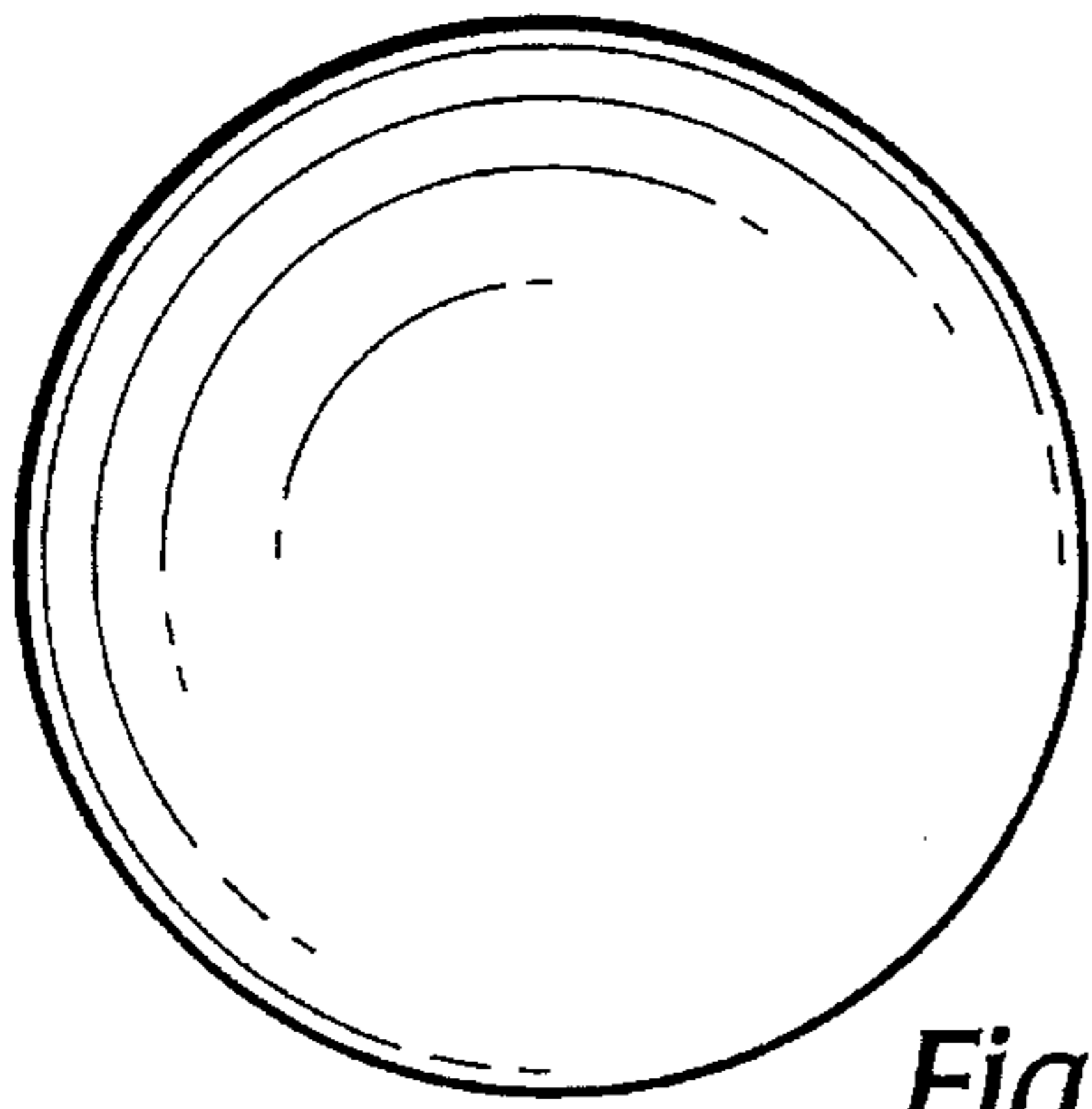

Fig. 2

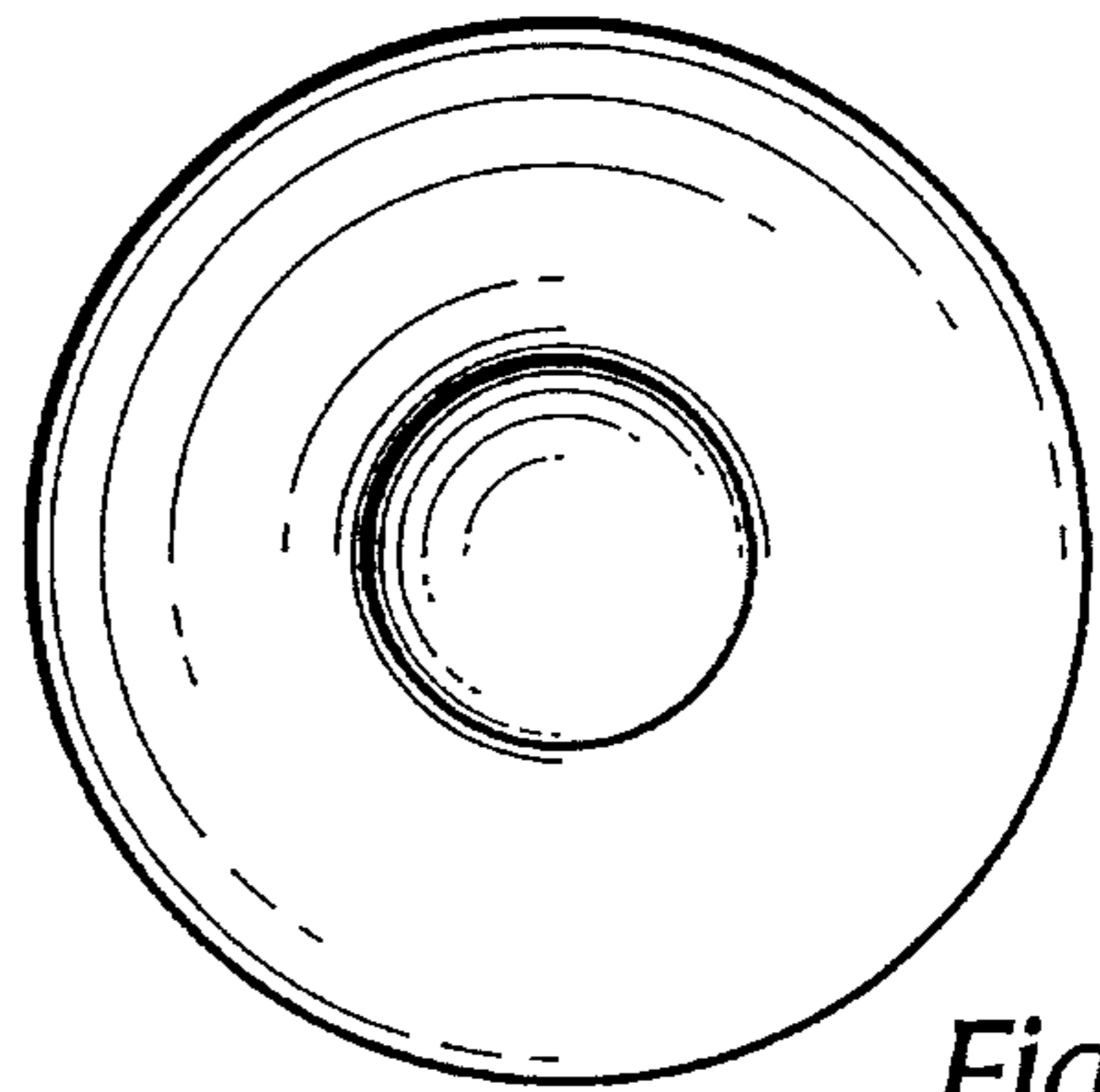

Fig. 3

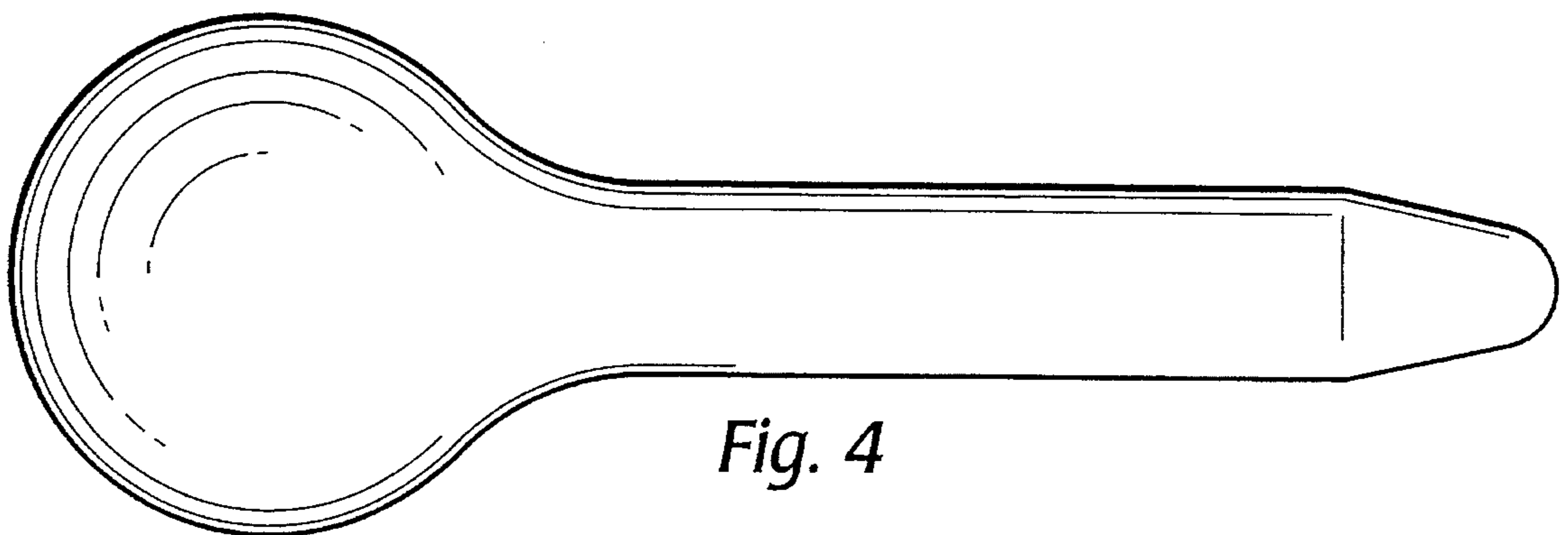

Fig. 4

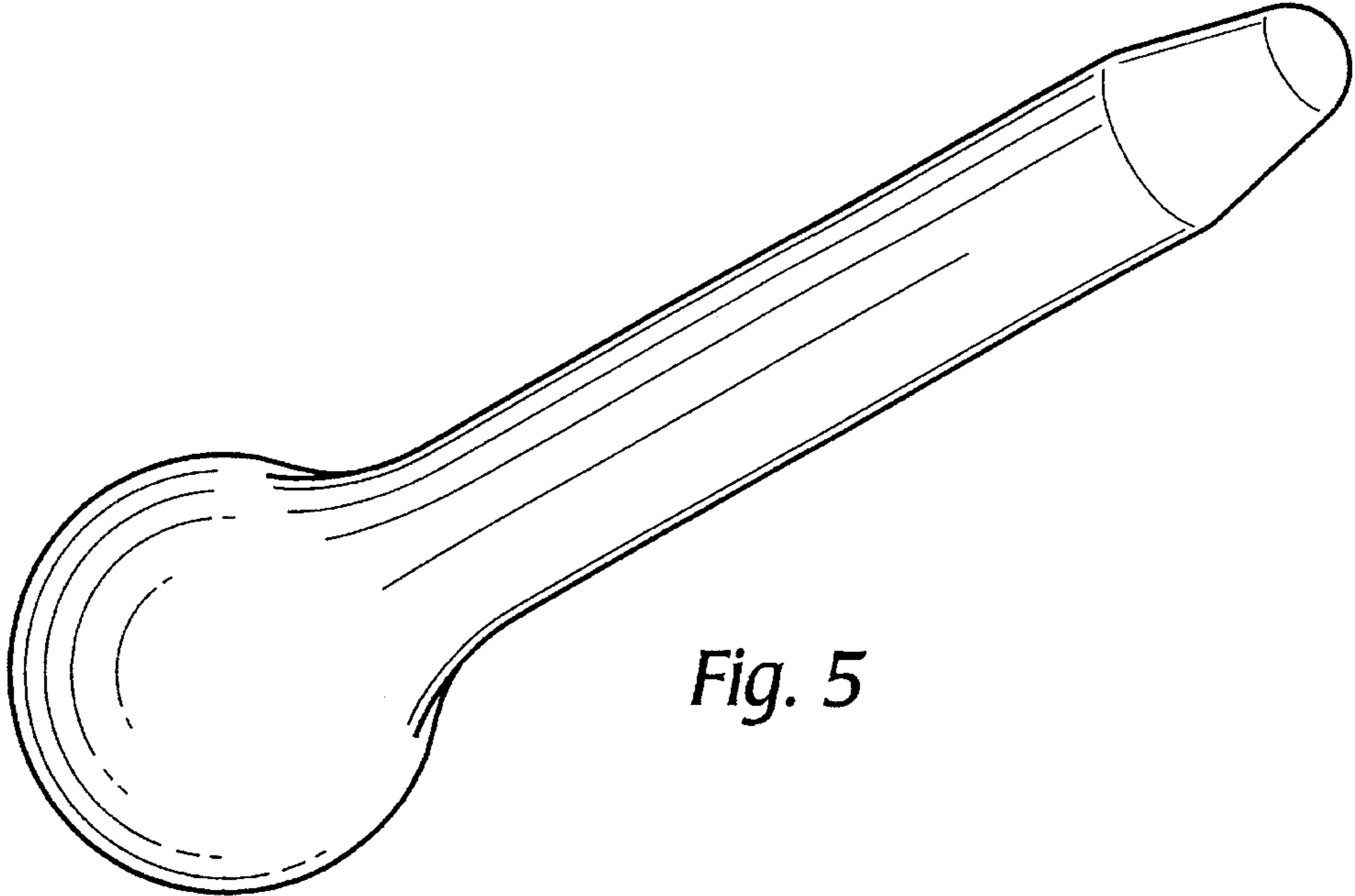

Fig. 5

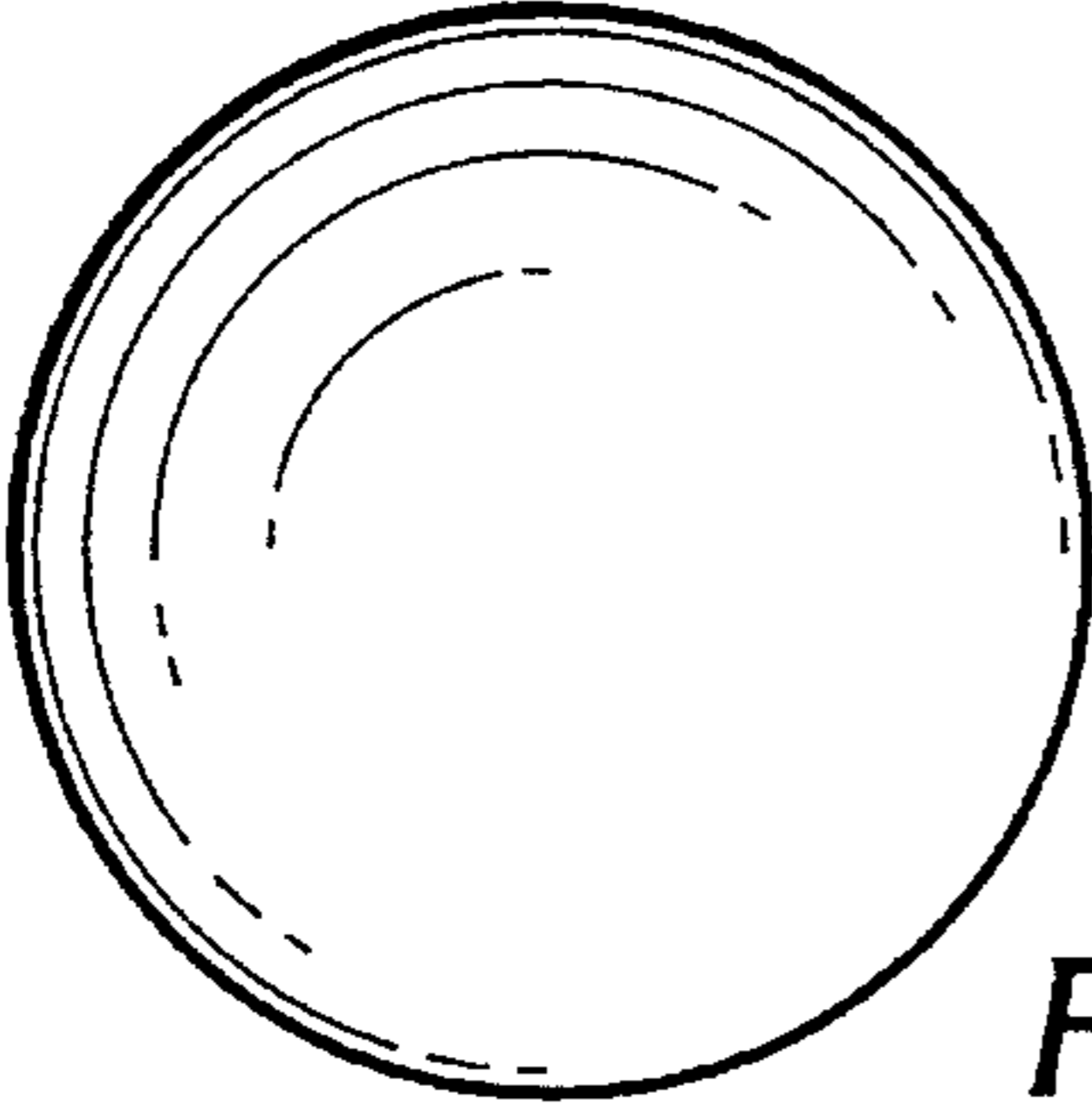

Fig. 6

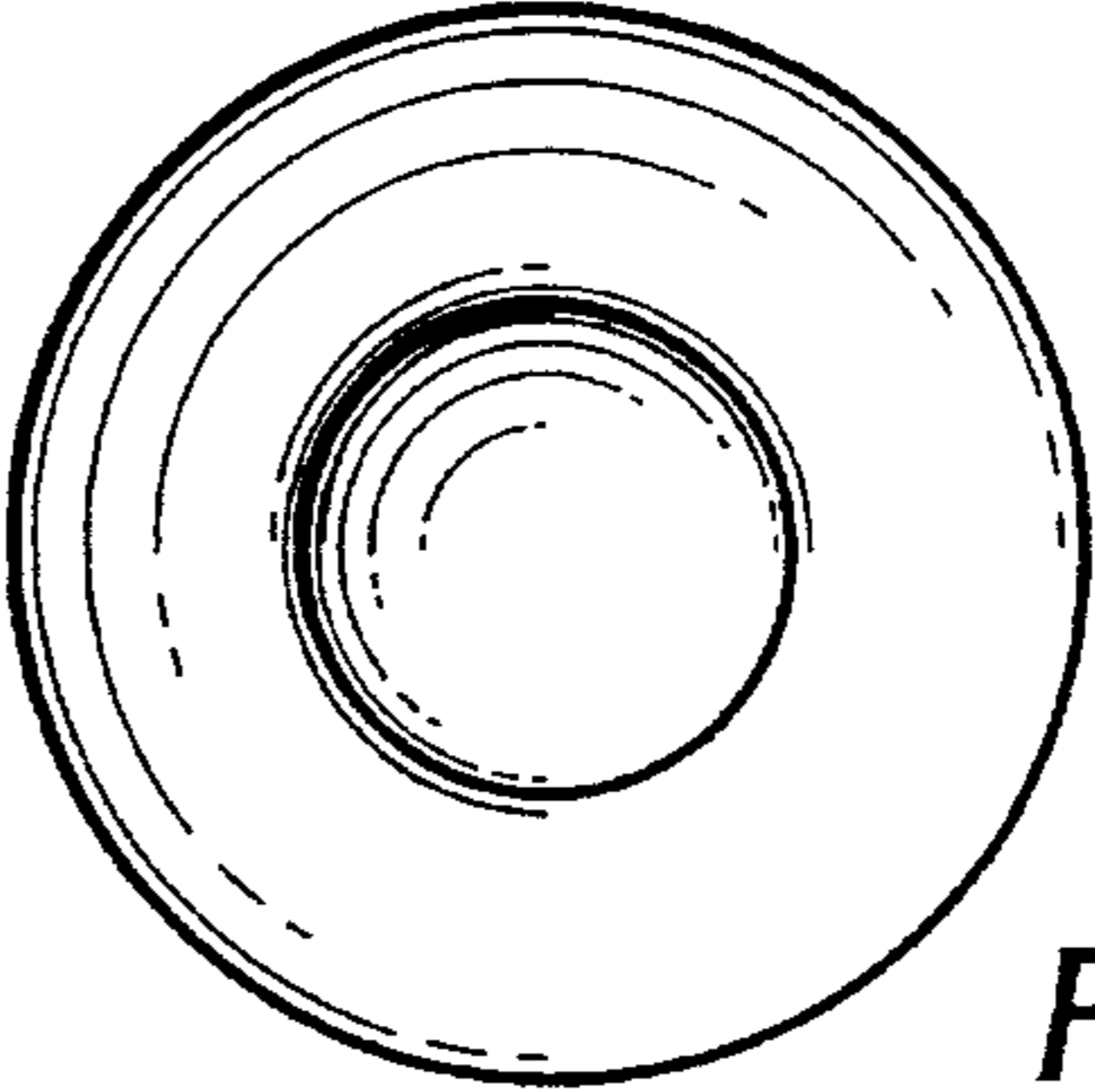

Fig. 7

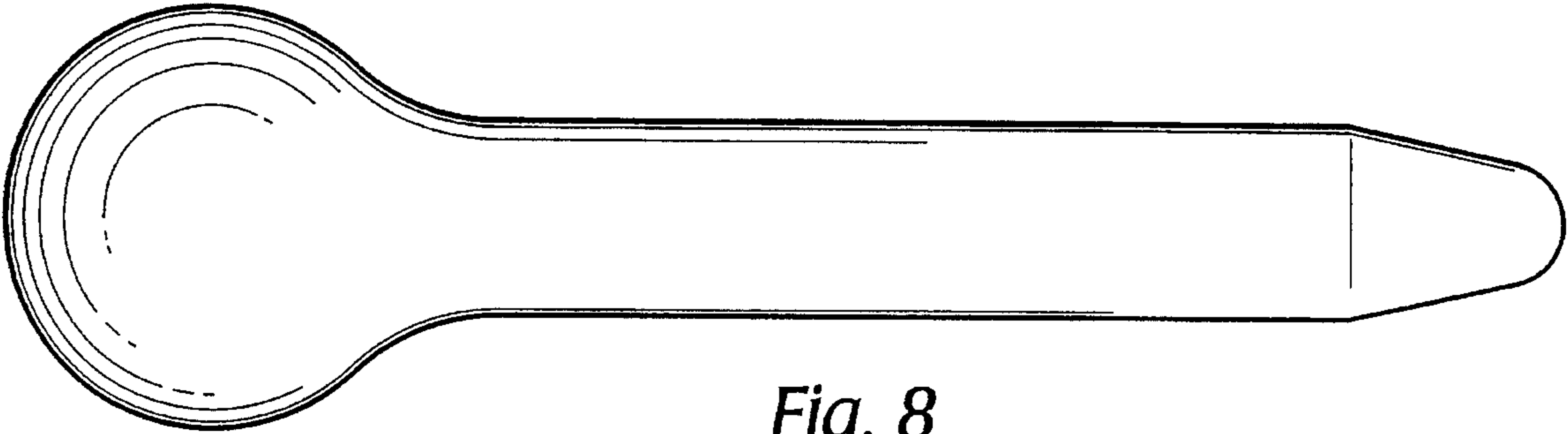

Fig. 8

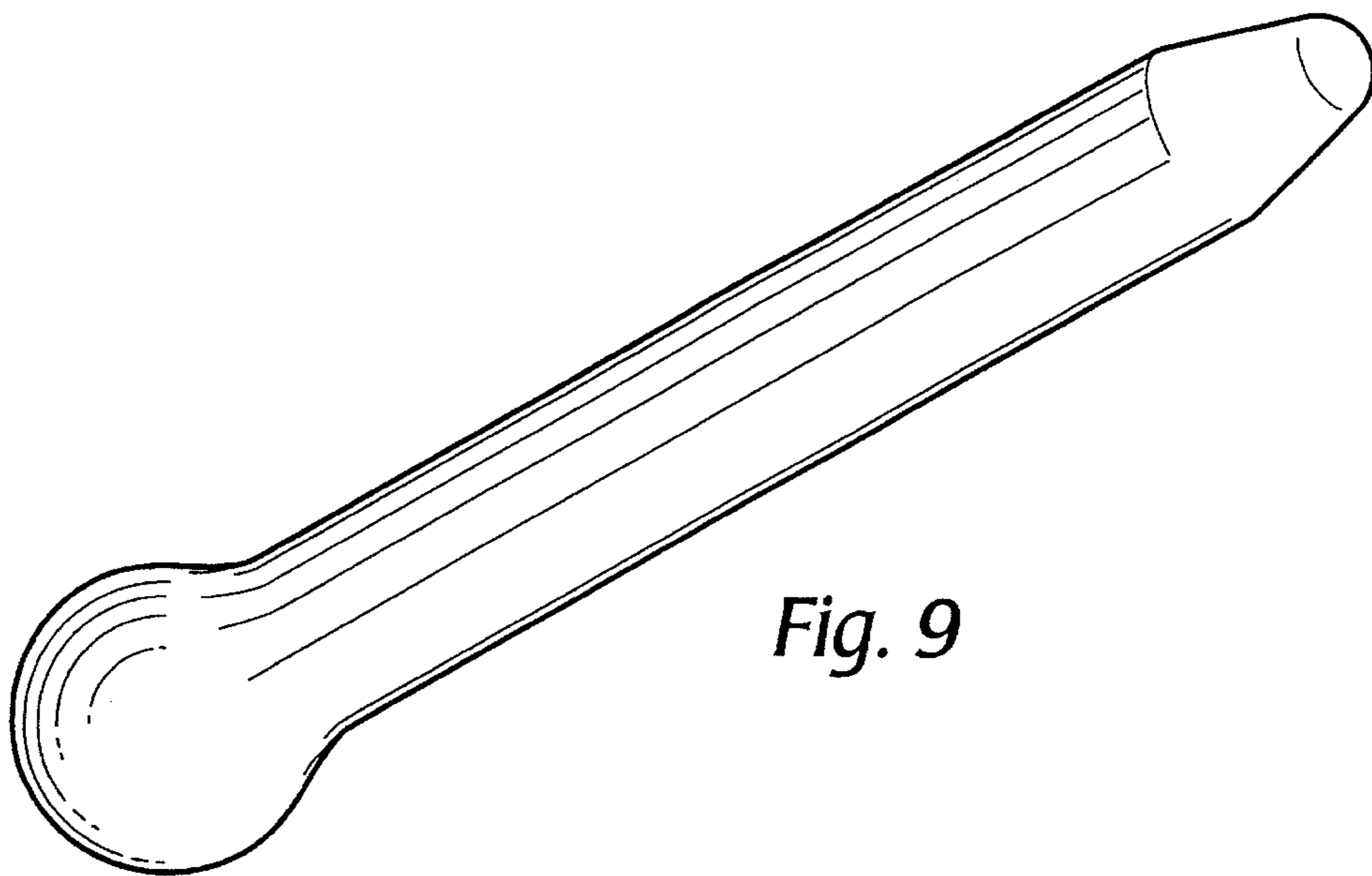

Fig. 9

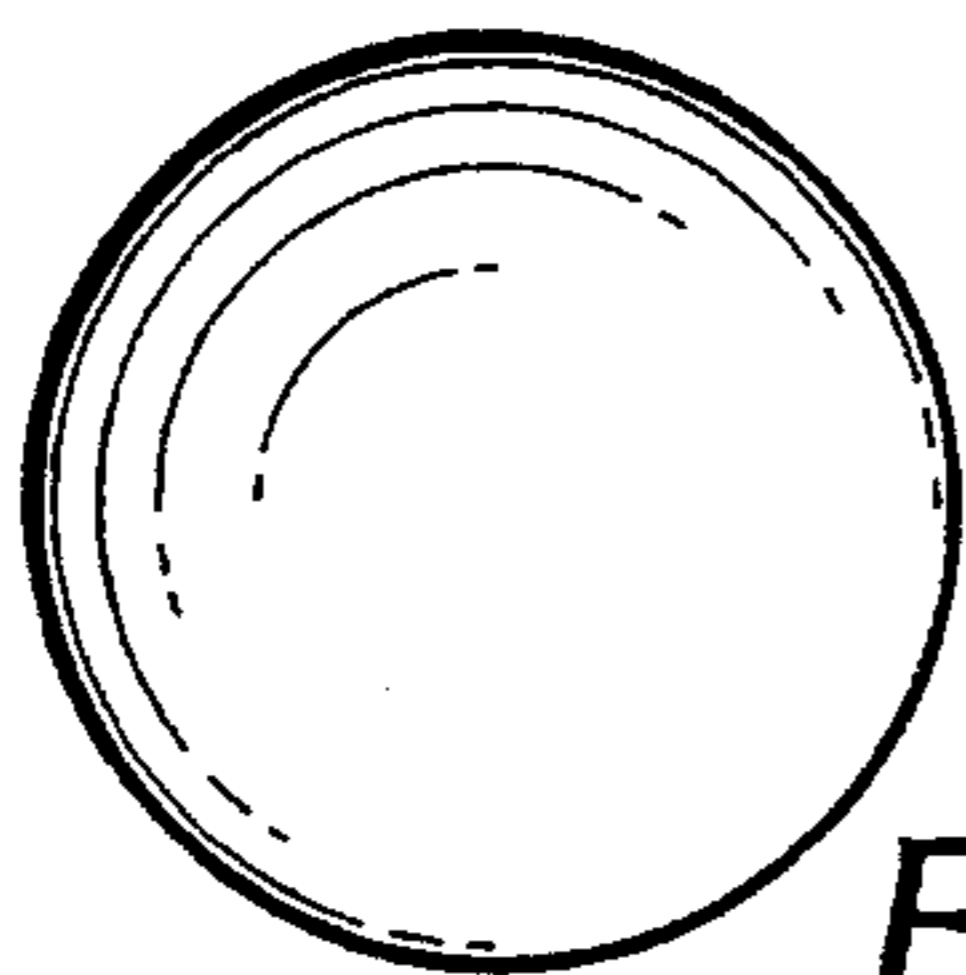

Fig. 10

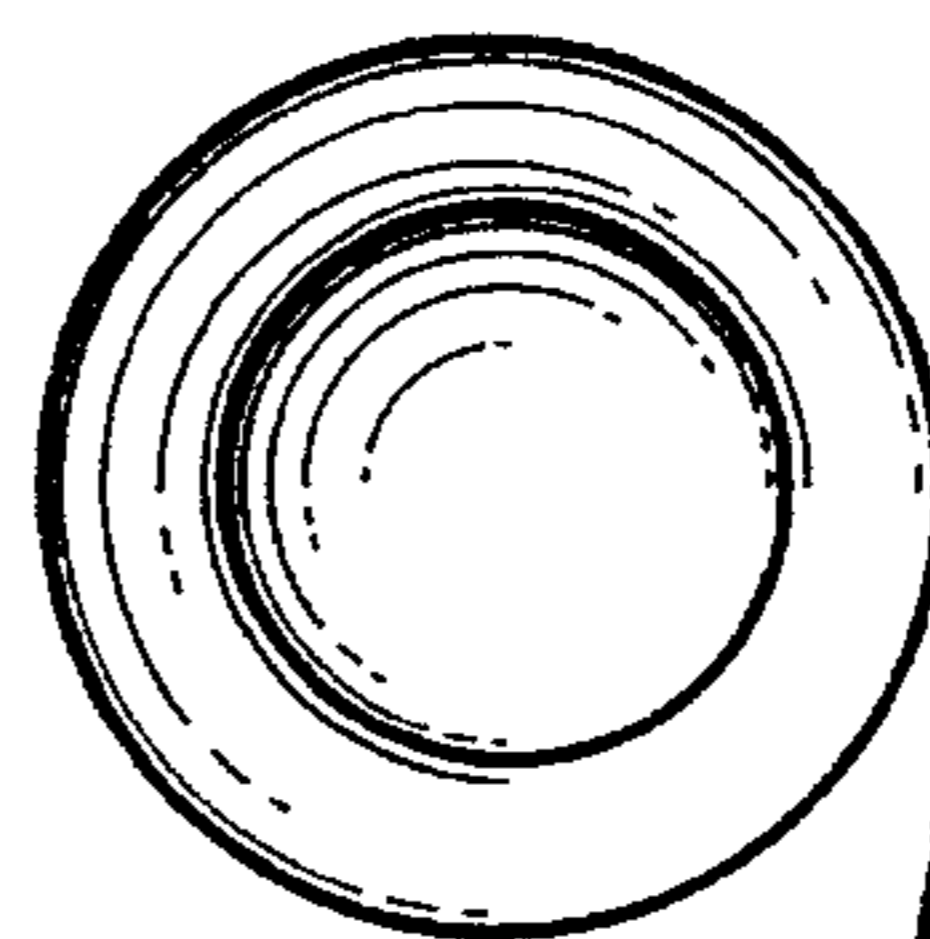

Fig. 11

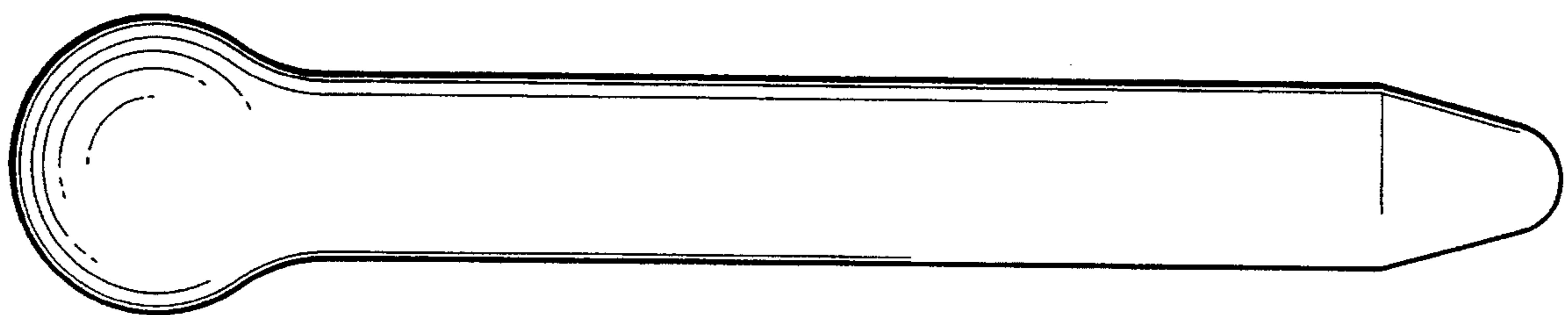

Fig. 12

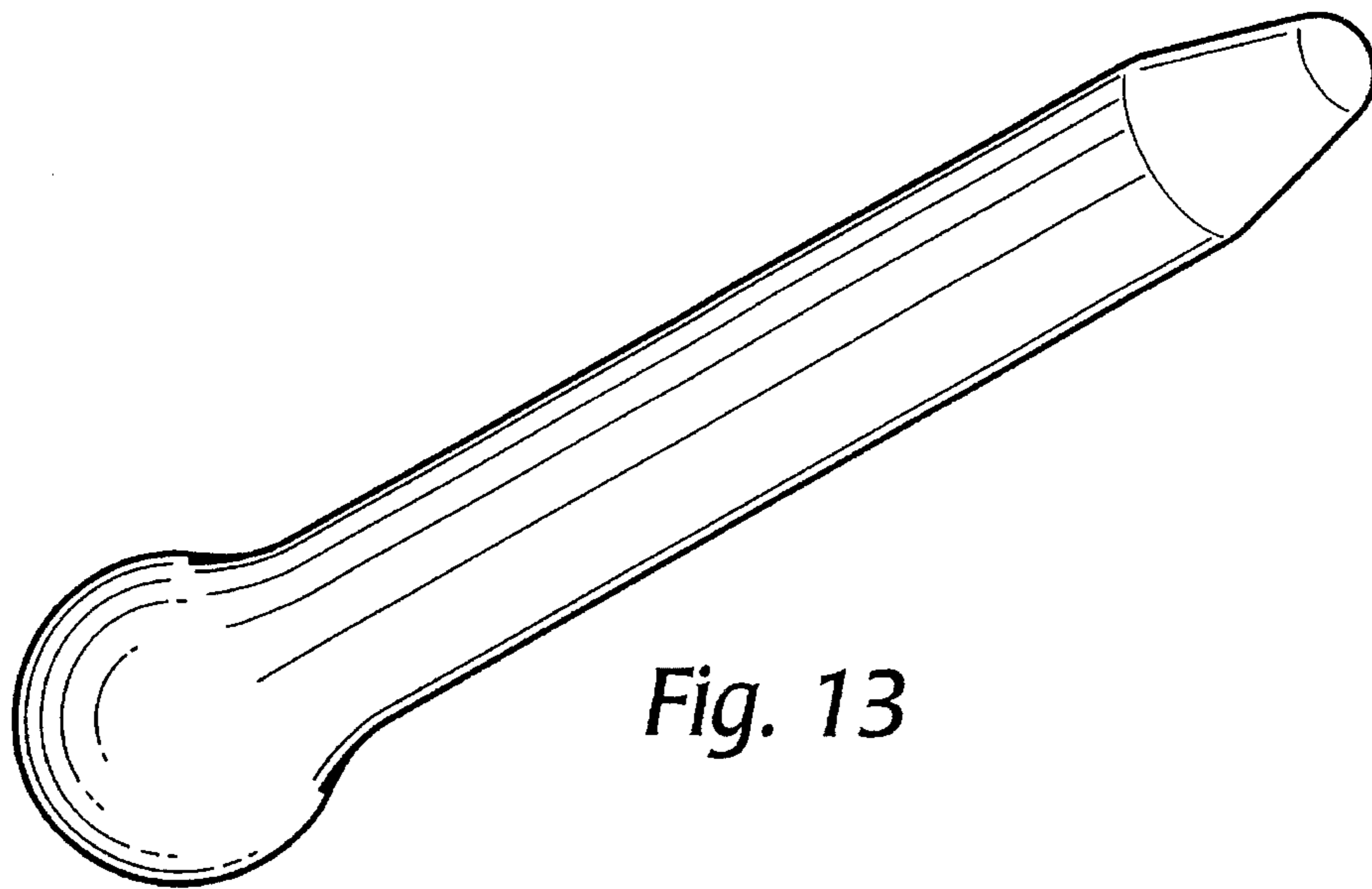

Fig. 13

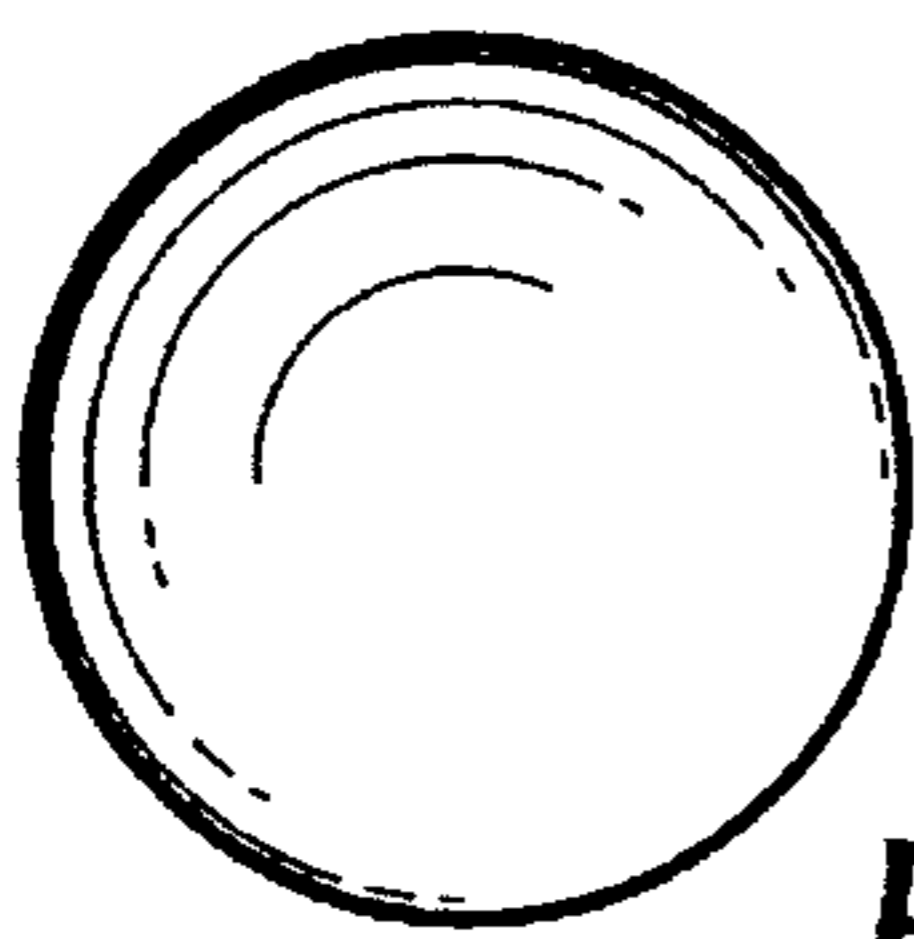

Fig. 14

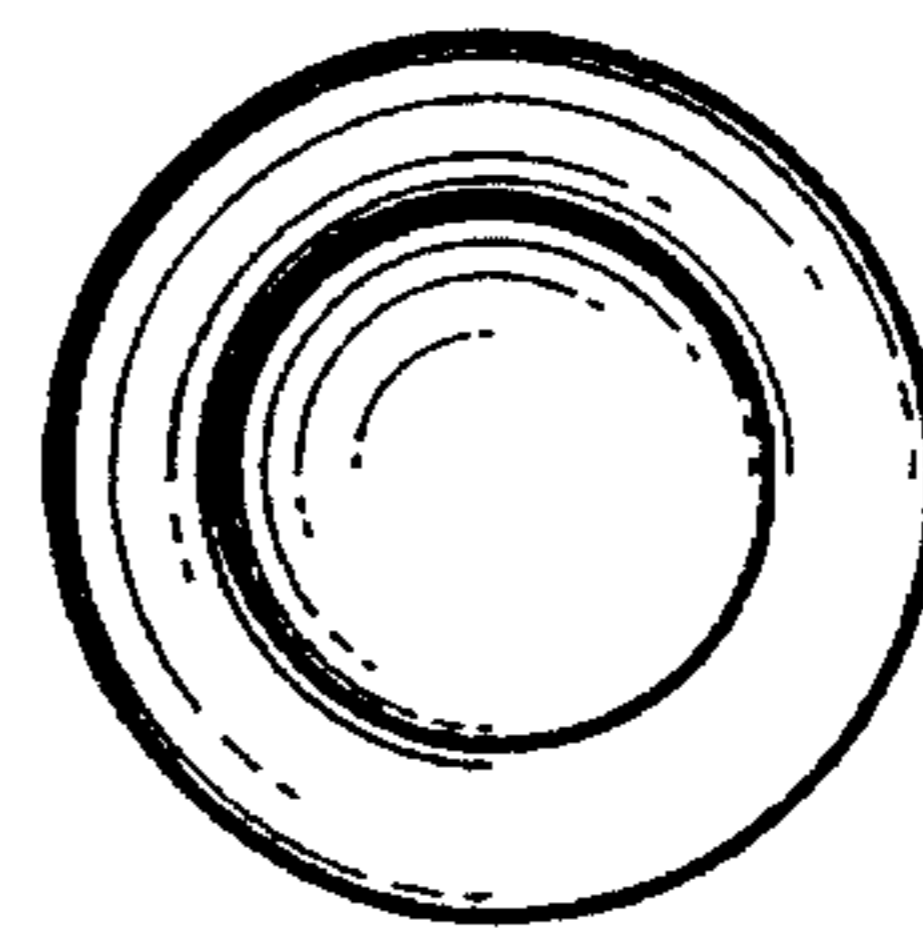

Fig. 15

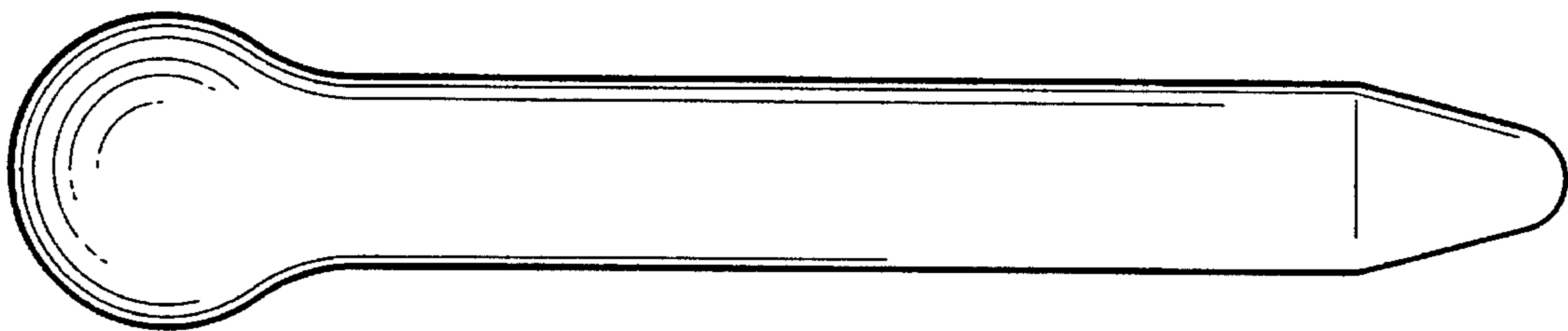

Fig. 16