



US00D371325S

**United States Patent** [19]  
**Fritsche**

[11] **Patent Number: Des. 371,325**  
[45] **Date of Patent: \*\*Jul. 2, 1996**

[54] **KEY CHAIN**

**FOREIGN PATENT DOCUMENTS**

[75] Inventor: **Joseph R. Fritsche**, Parma, Ohio

74271 5/1984 Canada .  
69343 10/1991 Canada .

[73] Assignee: **J.F. Sports Co.**, Cleveland, Ohio

**OTHER PUBLICATIONS**

[\*\*] Term: **14 Years**

Two Pages of 1995 Catalog from Itech Sports Products Inc. of Ville St. Laurent, Quebec, Canada.

[21] Appl. No.: **41,278**

*Primary Examiner*—Ralf Seifert  
*Attorney, Agent, or Firm*—Oldham & Oldham

[22] Filed: **Jul. 11, 1995**

[57] **CLAIM**

**Related U.S. Application Data**

The ornamental design for a key chain, as shown and described.

[63] Continuation of Ser. No. 30,264, Oct. 25, 1994, abandoned.

[52] **U.S. Cl.** ..... **D11/211**

**DESCRIPTION**

[58] **Field of Search** ..... D3/207, 212; D11/44, D11/48, 81, 91; 24/31 C; 70/456 R; D29/102

FIG. 1 is a perspective elevational view of a new design of a key chain;

[56] **References Cited**

FIG. 2 is a front elevational view;

**U.S. PATENT DOCUMENTS**

FIG. 3 is a right side elevational view, with reference to FIG. 1, the left side elevational view being a mirror image thereof;

D. 242,399 11/1976 Cox ..... D29/102

FIG. 4 is a rear view;

D. 279,772 7/1985 Bryer-Lindner ..... D11/81

FIG. 5 is a top view; and,

D. 312,148 11/1990 Nocchi ..... D29/109

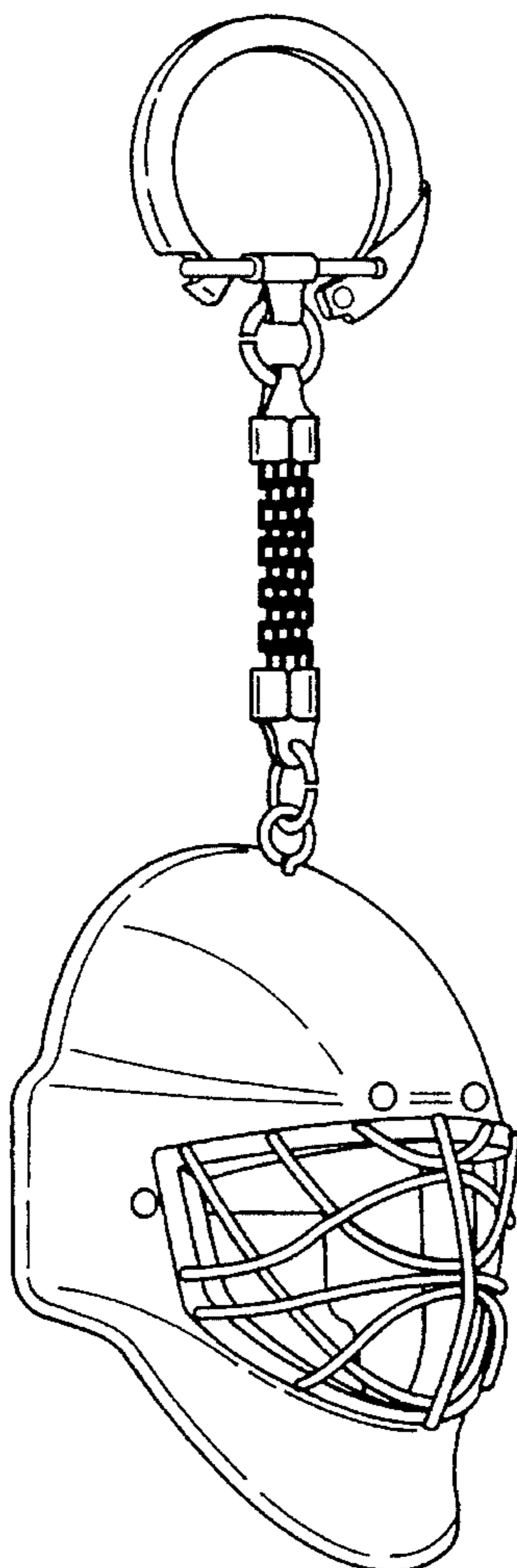
FIG. 6 is a bottom view.

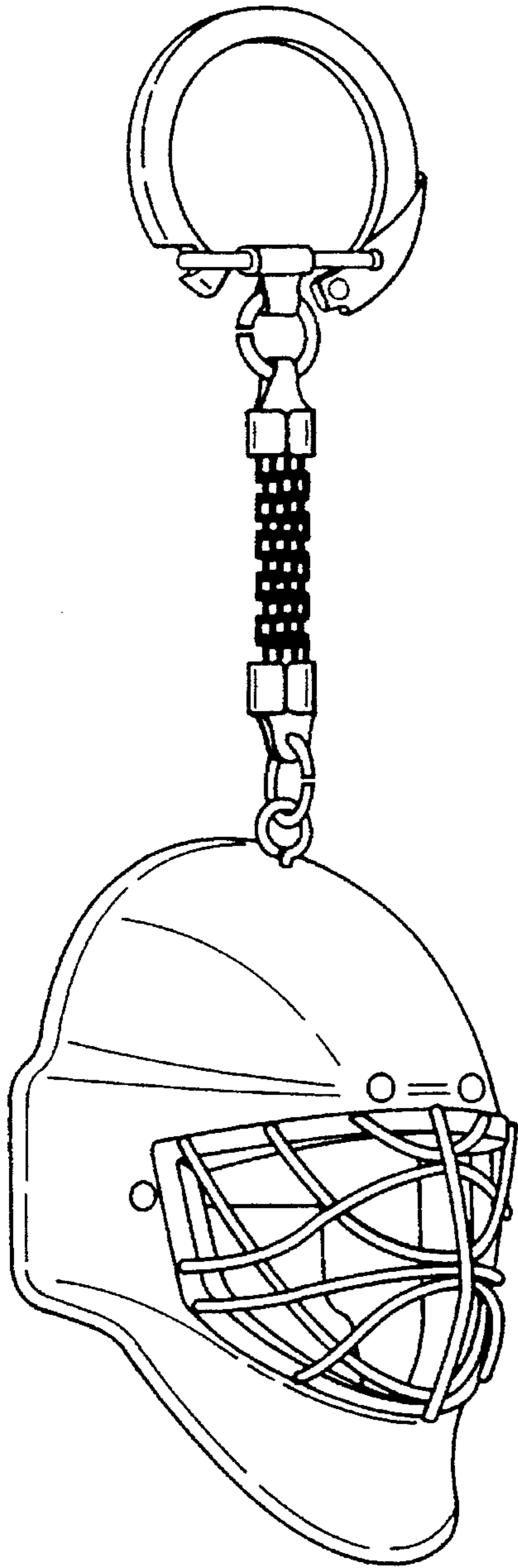
D. 321,787 11/1991 Kraus ..... D11/81

D. 342,692 12/1993 Lu ..... D11/81

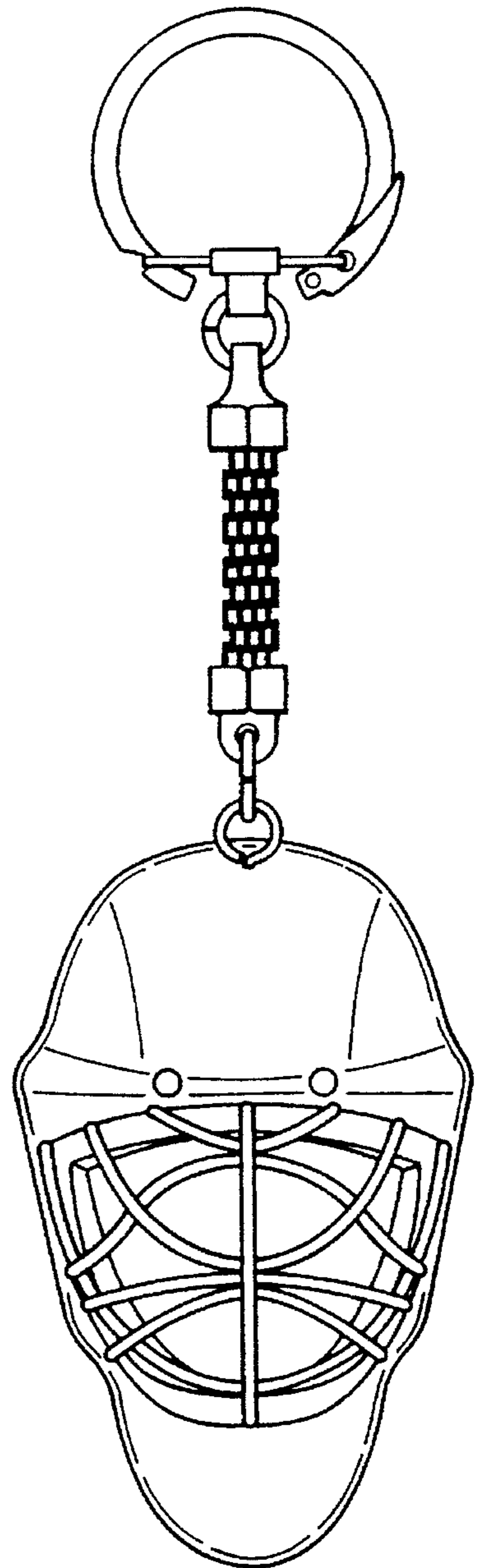
D. 355,394 2/1995 Bezener ..... D21/190

**1 Claim, 3 Drawing Sheets**

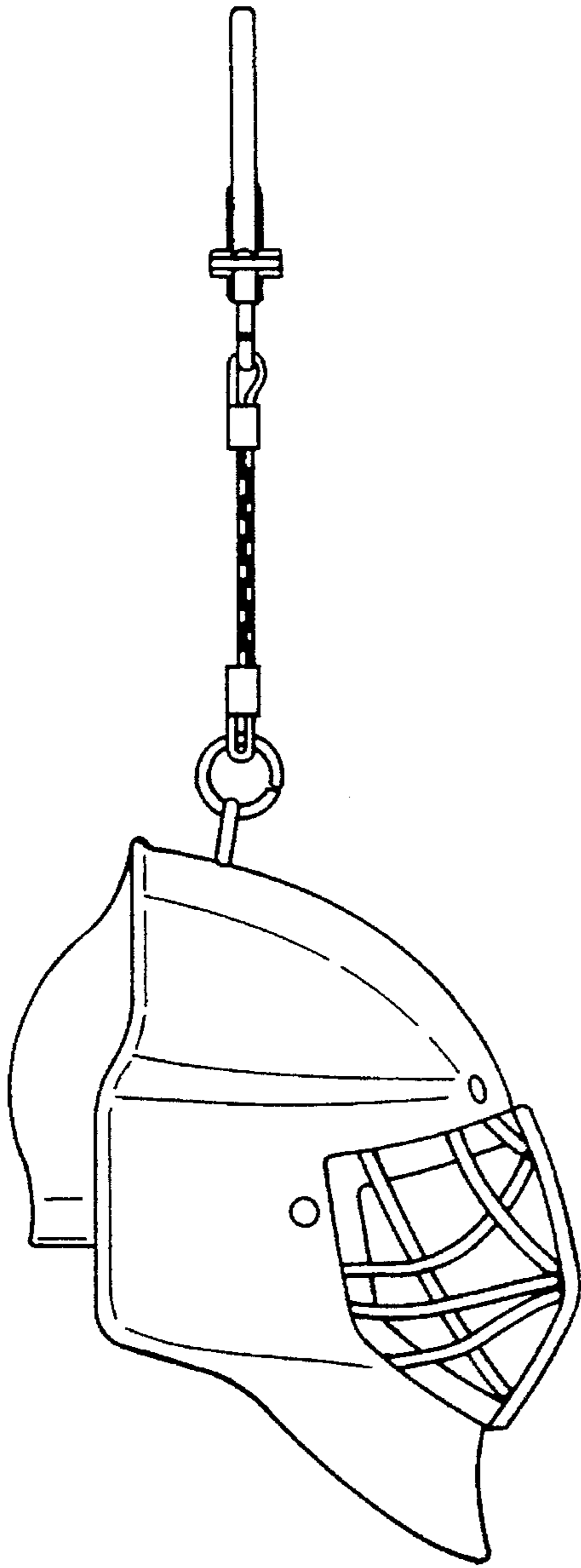




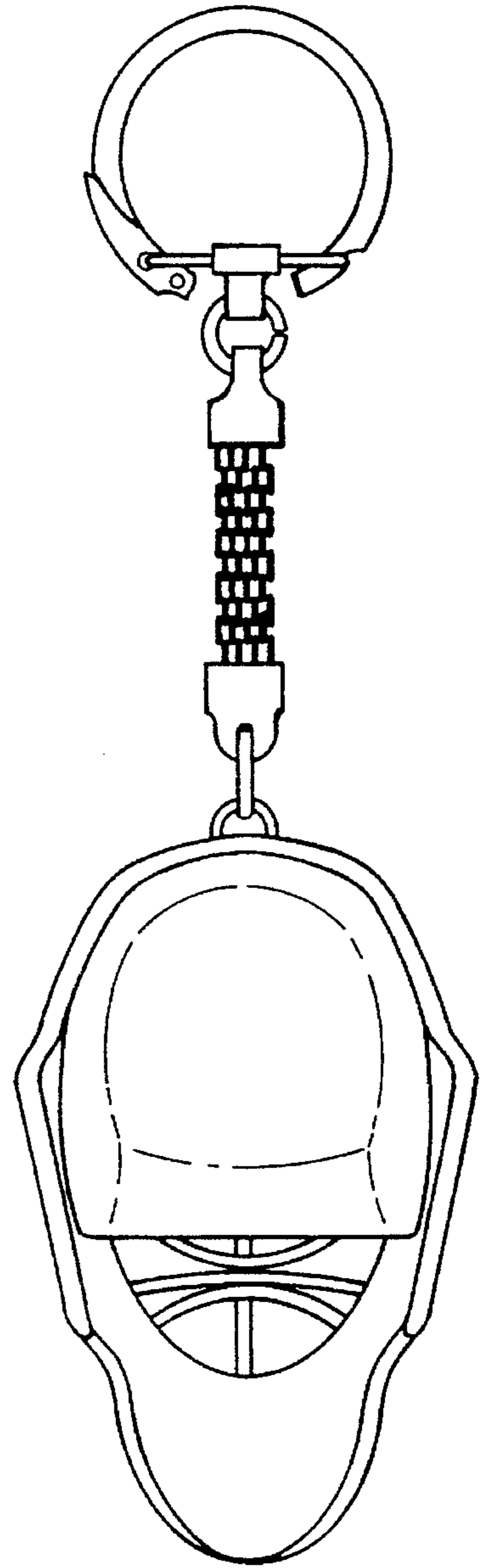
***Fig. 1***



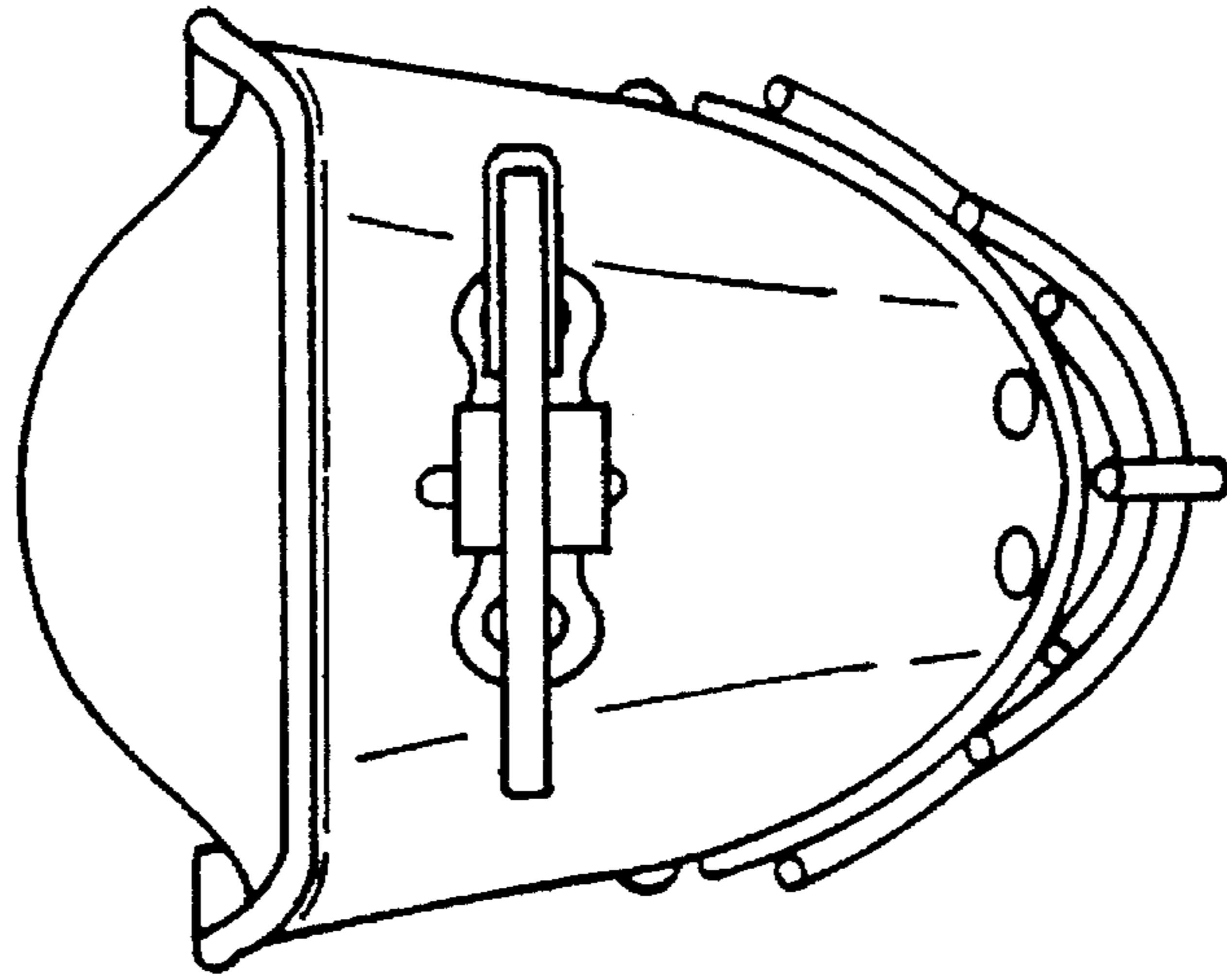
***Fig. 2***



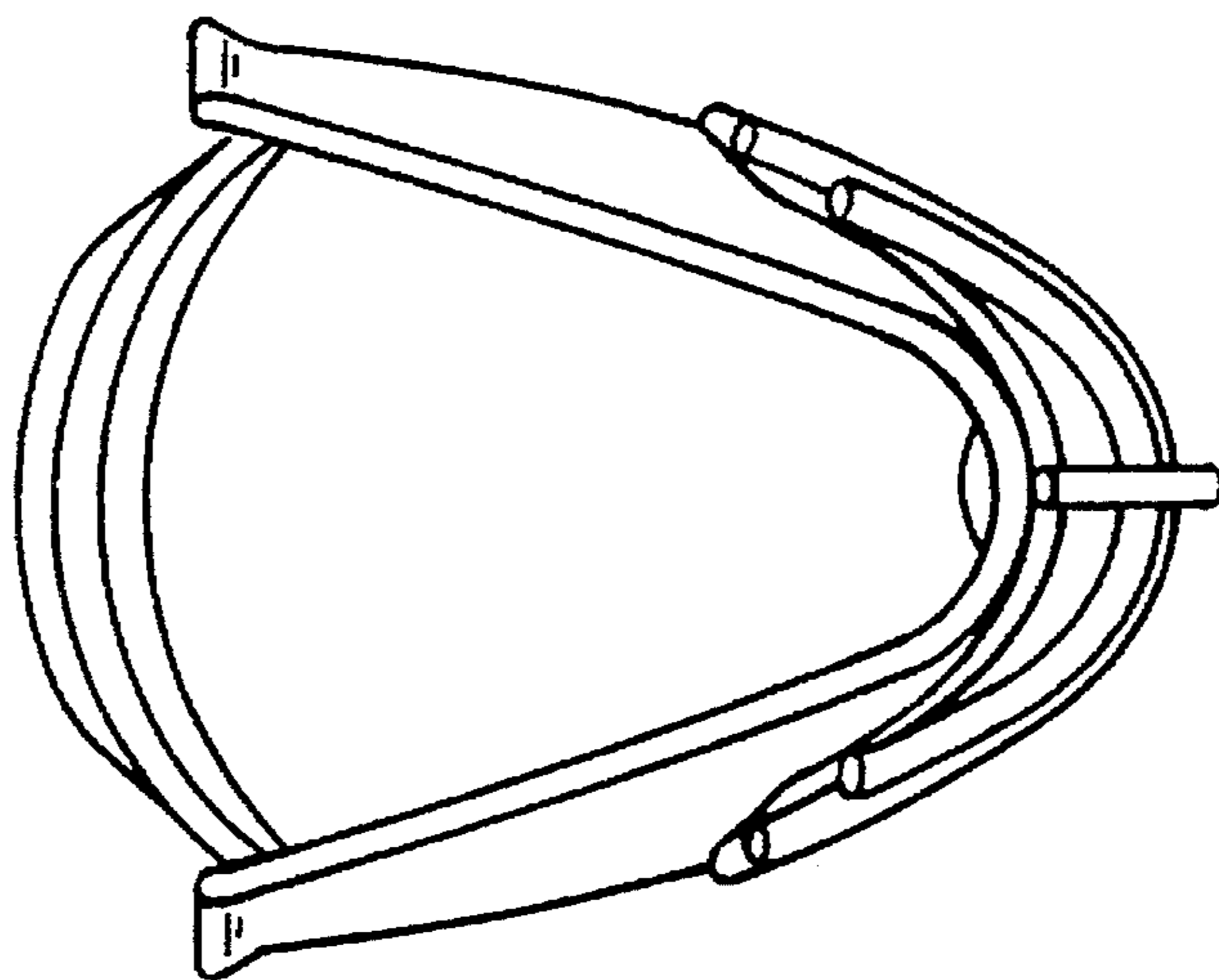
***Fig. 3***



***Fig. 4***



***Fig. 5***



***Fig. 6***