



US00D371324S

United States Patent [19]

[11] Patent Number: **Des. 371,324**

Weder et al.

[45] Date of Patent: ***** Jul. 2, 1996**

[54] **FLOWER POT COVER**

[75] Inventors: **Donald E. Weder; Joseph G. Straeter**, both of Highland, Ill.

[73] Assignees: **The Family Trust U/T/A; Southpac Trust International, Inc.**, both of Oklahoma City, Okla.

[*] Notice: The portion of the term of this patent subsequent to Oct. 3, 2009, has been disclaimed.

[**] Term: **14 Years**

[21] Appl. No.: **8,192**

[22] Filed: **May 10, 1993**

Related U.S. Application Data

[63] Continuation-in-part of Ser. No. 807,897, Dec. 16, 1991, which is a continuation-in-part of Ser. No. 710,272, Jun. 4, 1991, which is a continuation-in-part of Ser. No. 617,454, Nov. 21, 1990, abandoned, Ser. No. 411,249, Sep. 22, 1989, Pat. No. 358,113, Ser. No. 411,247, Sep. 22, 1989, and Ser. No. 411,245, Sep. 22, 1989, abandoned.

[52] U.S. Cl. **D11/164**

[58] Field of Search D11/143, 149, D11/152-156, 164, 89, 90; 47/66, 72; 206/423; 215/100.5; 229/1.5 R, 1.5 B, 4.5, 87.01, 922, 930, 108, 108.1, 109, 110; 428/27, 35.1, 24, 542.6; D9/346, 428-431; D27/102, 133; D26/128-136; D19/96; D7/540, 584, 586, 587, 354

[56] References Cited

U.S. PATENT DOCUMENTS

D. 292,182	10/1987	Weder et al.	D11/164
D. 292,562	11/1987	Weder et al.	D11/164
D. 293,224	12/1987	Weder et al.	D11/164
D. 293,775	1/1988	Weder et al.	D11/164
D. 315,534	3/1991	Weder et al.	D11/164
D. 317,583	6/1991	Weder et al.	D11/164
D. 318,030	7/1991	Weder et al.	D11/164
D. 327,234	6/1992	Vaughn	D11/143
1,065,486	6/1913	Washburn	229/400
2,054,934	9/1936	Graffenberger	229/1.5 B

2,102,510	12/1937	Cecil, 2D	229/1.5 B
2,355,559	8/1944	Renner	229/8
2,459,073	1/1949	Hamilton	229/1.5 B
5,127,817	7/1992	Weder et al.	425/383
5,339,565	8/1994	Weder et al.	229/1.5 BX

FOREIGN PATENT DOCUMENTS

103316	3/1938	Australia	229/922
--------	--------	-----------------	---------

OTHER PUBLICATIONS

Exhibit A—Speed Cover® Brochure—The Simple Solution . . . , ©1989.

Primary Examiner—Jeffrey Asch
Attorney, Agent, or Firm—Dunlap & Codding

[57] CLAIM

The ornamental design for a flower pot cover, as shown and described.

DESCRIPTION

FIG. 1 is a perspective view of our new flower pot cover design;
 FIG. 2 is a side elevational view thereof;
 FIG. 3 is a top plan view thereof;
 FIG. 4 is a bottom plan view thereof;
 FIG. 5 is a side elevational view of the design of FIG. 1, the only difference being in the horizontal angle of the skirt;
 FIG. 6 is a side elevational view of the design of FIG. 1, the only difference being in the near vertical angle of the skirt;
 FIG. 7 is a side elevational view of the design of FIG. 1, the only difference being in the downward angle of the skirt;
 FIG. 8 is a fragmentary enlarged top plan view of a second embodiment of the design of FIG. 1, the only difference being in the skirt edge;
 FIG. 9 is a fragmentary enlarged top plan view of a third embodiment of the design of FIG. 1, the only difference being in the skirt edge;
 FIG. 10 is a fragmentary enlarged top plan view of a fourth embodiment of the design of FIG. 1, the only difference being in the skirt edge;
 FIG. 11 is a perspective view of a fifth embodiment of our new flower pot cover design;
 FIG. 12 is a side elevational view thereof;
 FIG. 13 is a top plan view thereof;
 FIG. 14 is a bottom plan view thereof;

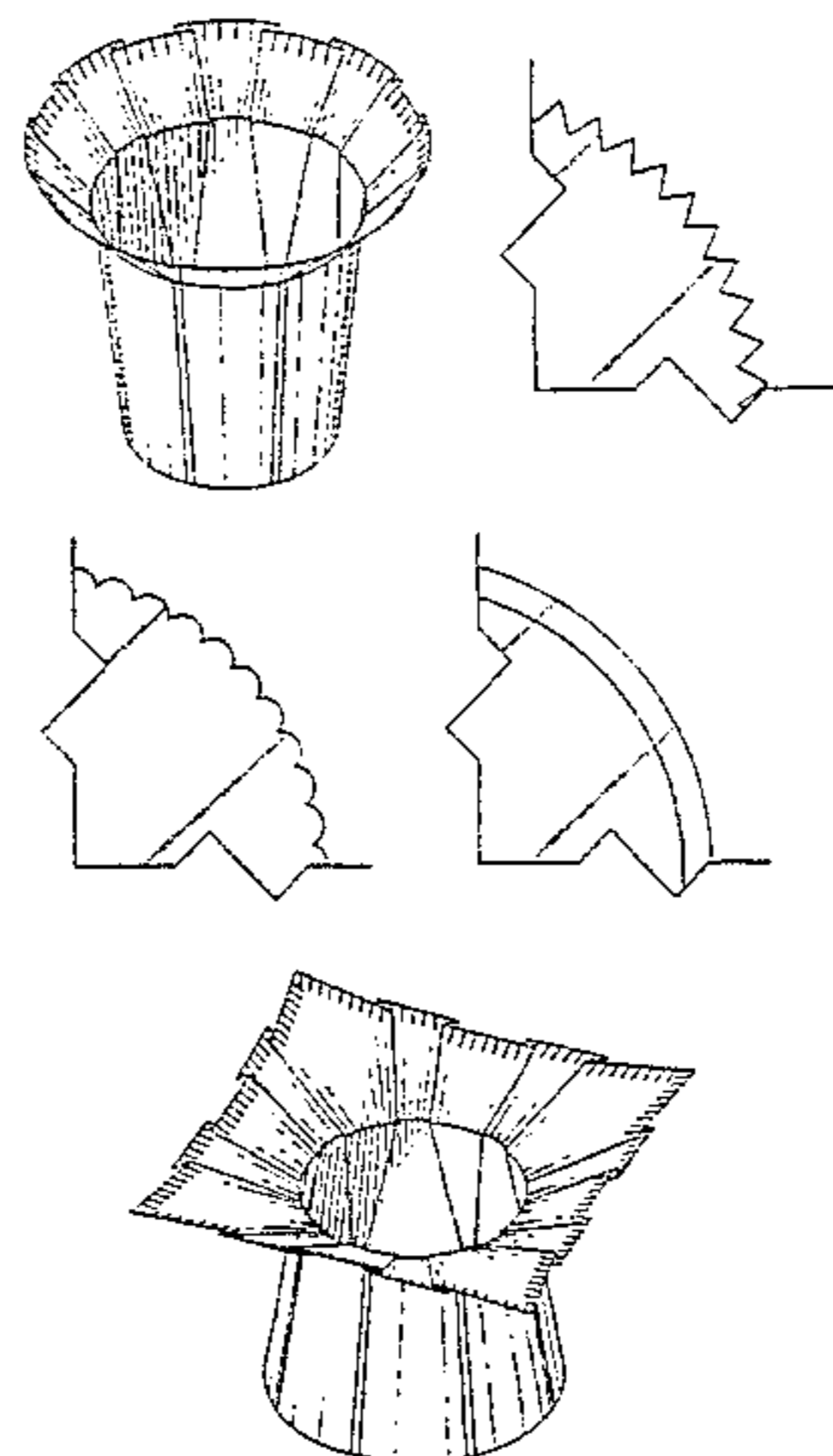

FIG. 15 is a side elevational view of the design of FIG. 11, the only difference being in the horizontal angle of the skirt;
FIG. 16 is a side elevational view of the design of FIG. 11, the only difference being in the near vertical angle of the skirt;
FIG. 17 is a side elevational view of the design of FIG. 11, the only difference being in the downward angle of the skirt;
FIG. 18 is a fragmentary enlarged top plan view of a sixth embodiment of the flower pot cover design, the only difference over FIG. 11 being in the skirt edge;
FIG. 19 is a fragmentary enlarged top plan view of a seventh embodiment of the flower pot cover design, the only difference over FIG. 11 being in the skirt edge;
FIG. 20 is a fragmentary enlarged top plan view of an eighth embodiment of the flower pot cover design, the only difference over FIG. 11 being in the skirt edge;
FIG. 21 is a perspective view of a ninth embodiment of our new flower pot cover design;
FIG. 22 is a side elevational view thereof;
FIG. 23 is a top plan view thereof;
FIG. 24 is a bottom plan view thereof;
FIG. 25 is a side elevational view of the design of FIG. 21, the only difference being in the horizontal angle of the skirt;
FIG. 26 is a side elevational view of the design of FIG. 21, the only difference being in the near vertical angle of the skirt;
FIG. 27 is a side elevational view of the design of FIG. 21, the only difference being in the downward angle of the skirt;
FIG. 28 is a perspective view of a tenth embodiment of our new flower pot cover design;
FIG. 29 is a side elevational view thereof;
FIG. 30 is a top plan view thereof;
FIG. 31 is a bottom plan view thereof;
FIG. 32 is a side elevational view of the design of FIG. 28, the only difference being in the horizontal angle of the skirt;

FIG. 33 is a side elevational view of the design of FIG. 28, the only difference being in the near vertical angle of the skirt;
FIG. 34 is a side elevational view of the design of FIG. 28, the only difference being in the downward angle of the skirt;
FIG. 35 is a fragmentary enlarged top plan view of an eleventh embodiment of the flower pot cover design, the only difference over FIG. 28 being in the skirt edge;
FIG. 36 is a fragmentary enlarged top plan view of a twelfth embodiment of the flower pot cover design, the only difference over FIG. 28 being in the skirt edge;
FIG. 37 is a fragmentary enlarged top plan view of a thirteenth embodiment of the flower pot cover design, the only difference over FIG. 28 being in the skirt edge;
FIG. 38 is a perspective view of a fourteenth embodiment of our new flower pot cover design;
FIG. 39 is a side elevational view thereof;
FIG. 40 is a top plan view thereof;
FIG. 41 is a bottom plan view thereof;
FIG. 42 is a side elevational view of the design of FIG. 38, the only difference being in the horizontal angle of the skirt;
FIG. 43 is a side elevational view of the design of FIG. 38, the only difference being in the near vertical angle of the skirt; and,
FIG. 44 is a side elevational view of the design of FIG. 38, the only difference being in the downward angle of the skirt.
The characteristic feature of the design resides in the specific pleating arrangement, comprised of the parallel disposition of the exterior folds, in combination with the interior V-shaped folds, all as best seen in FIGS. 1, 11, 21, 28 and 38.
The flower pot cover has no substantial thickness.

1 Claim, 9 Drawing Sheets

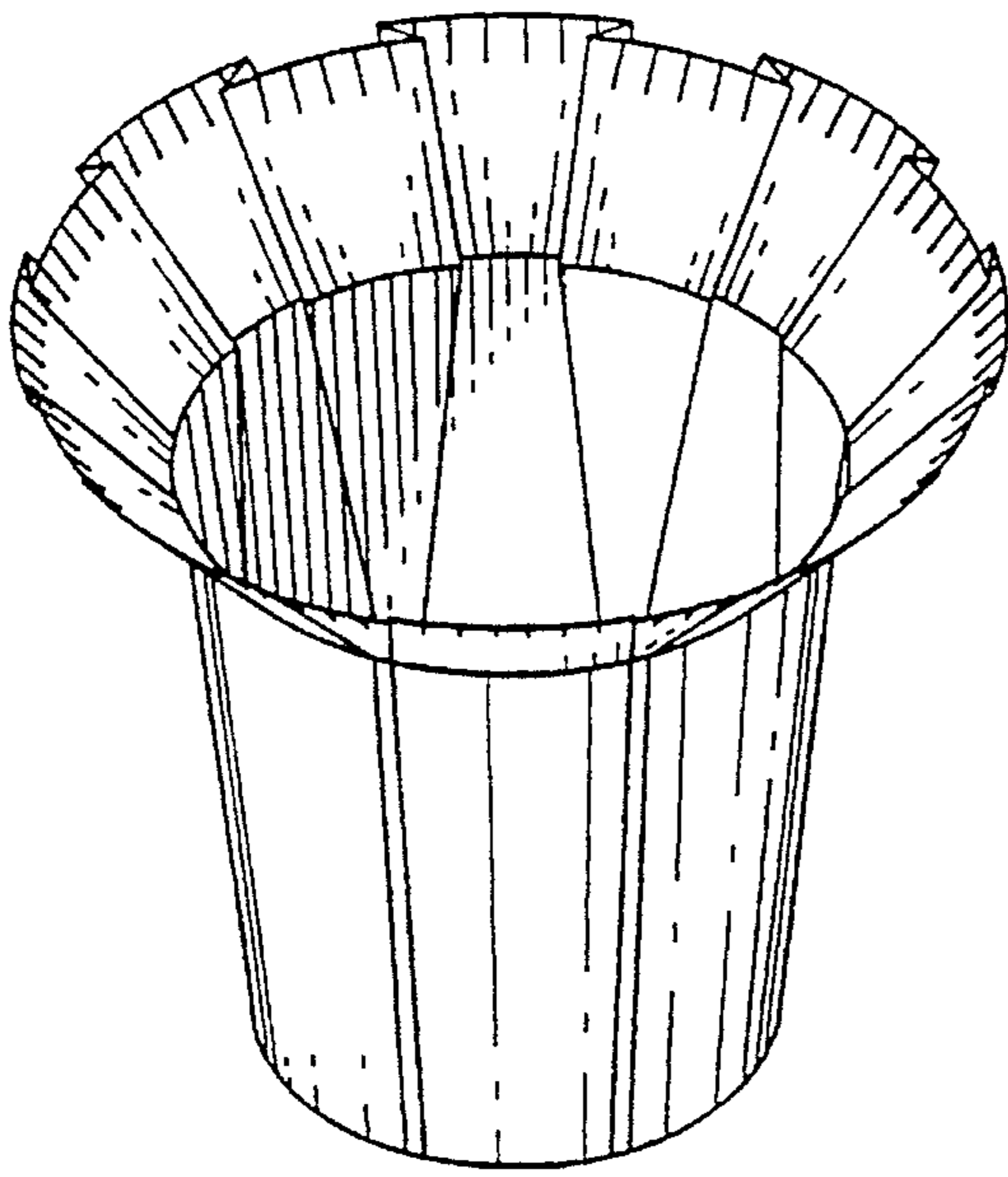

Fig. 1

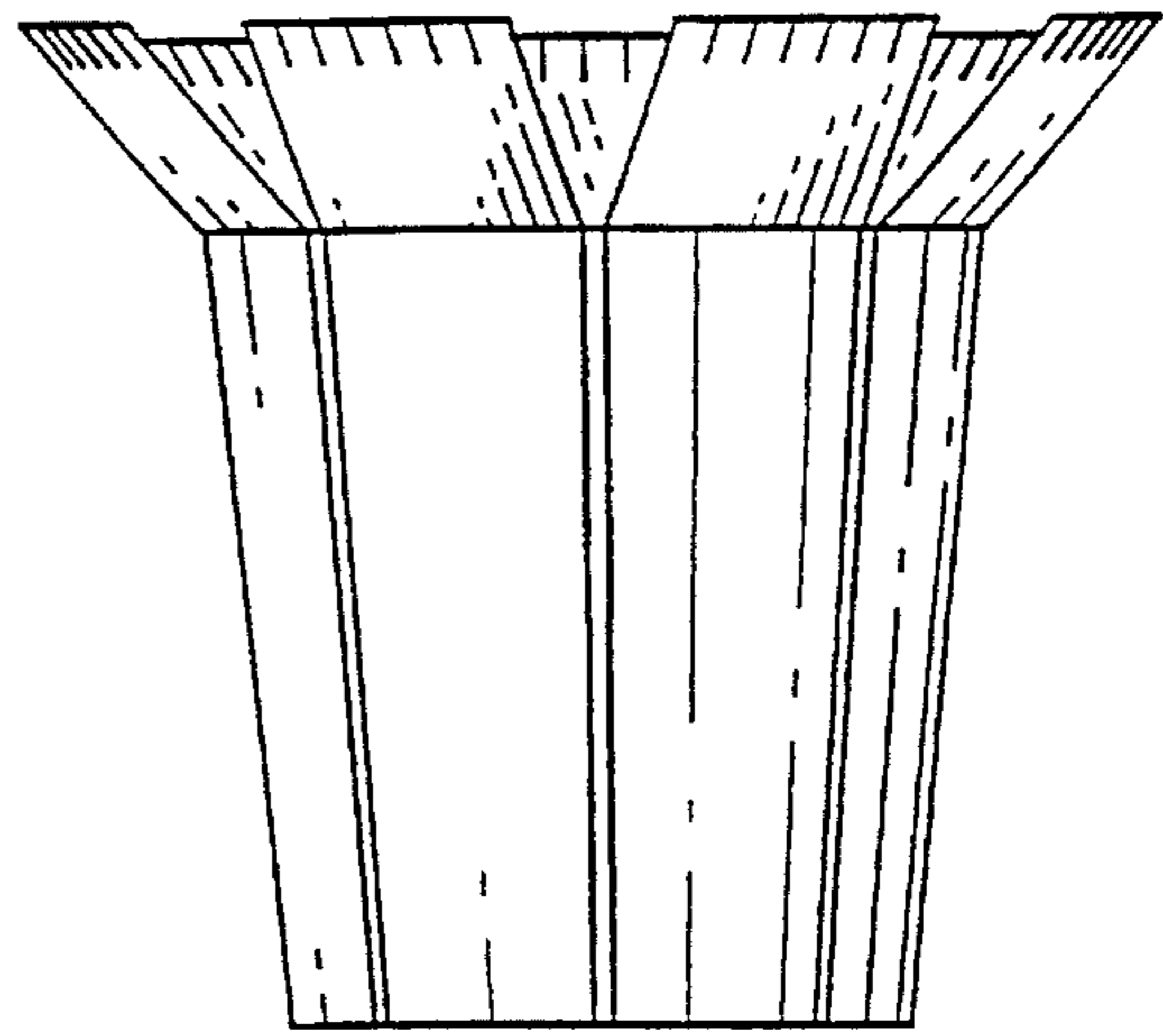

Fig. 2

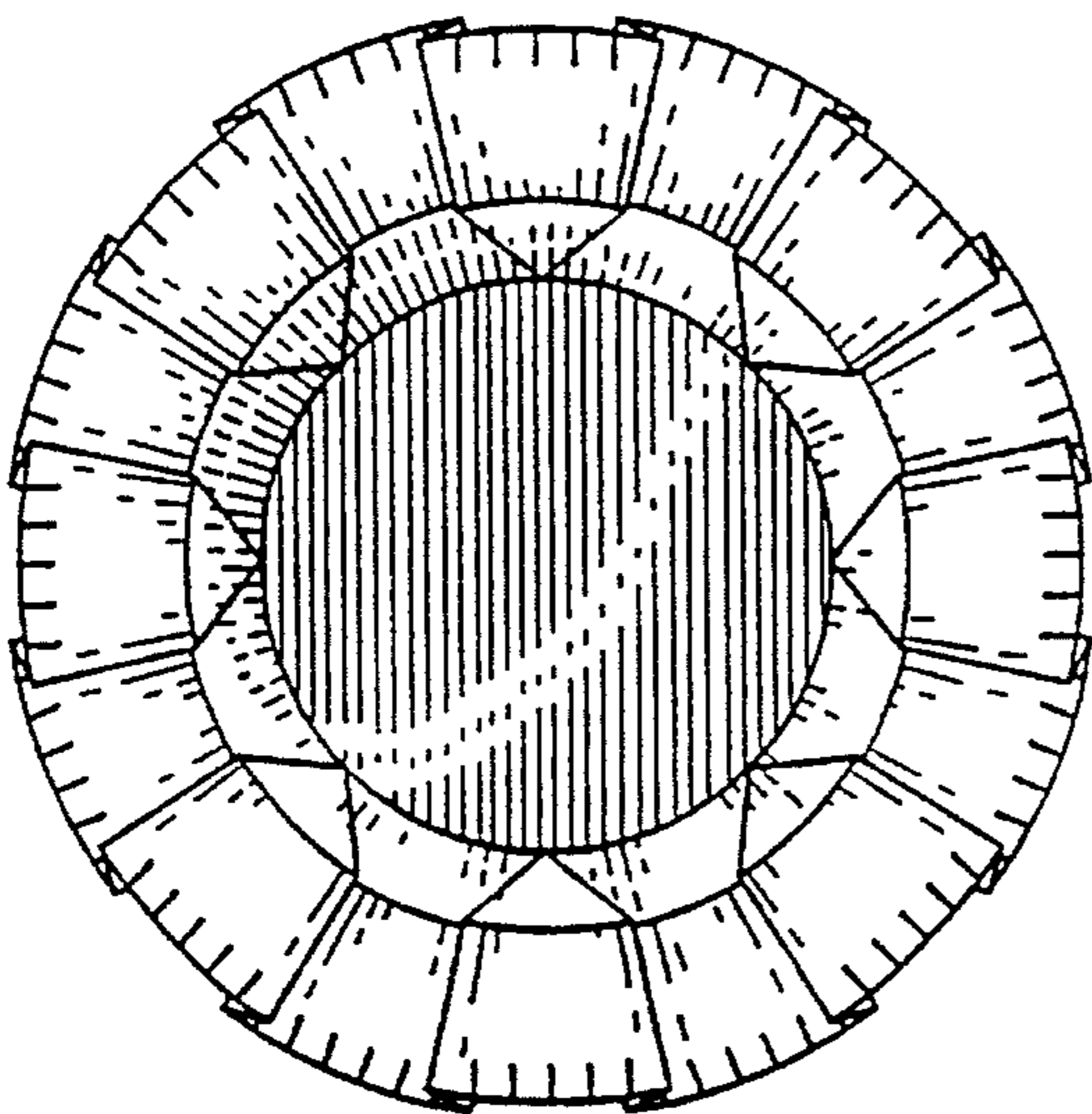

Fig. 3

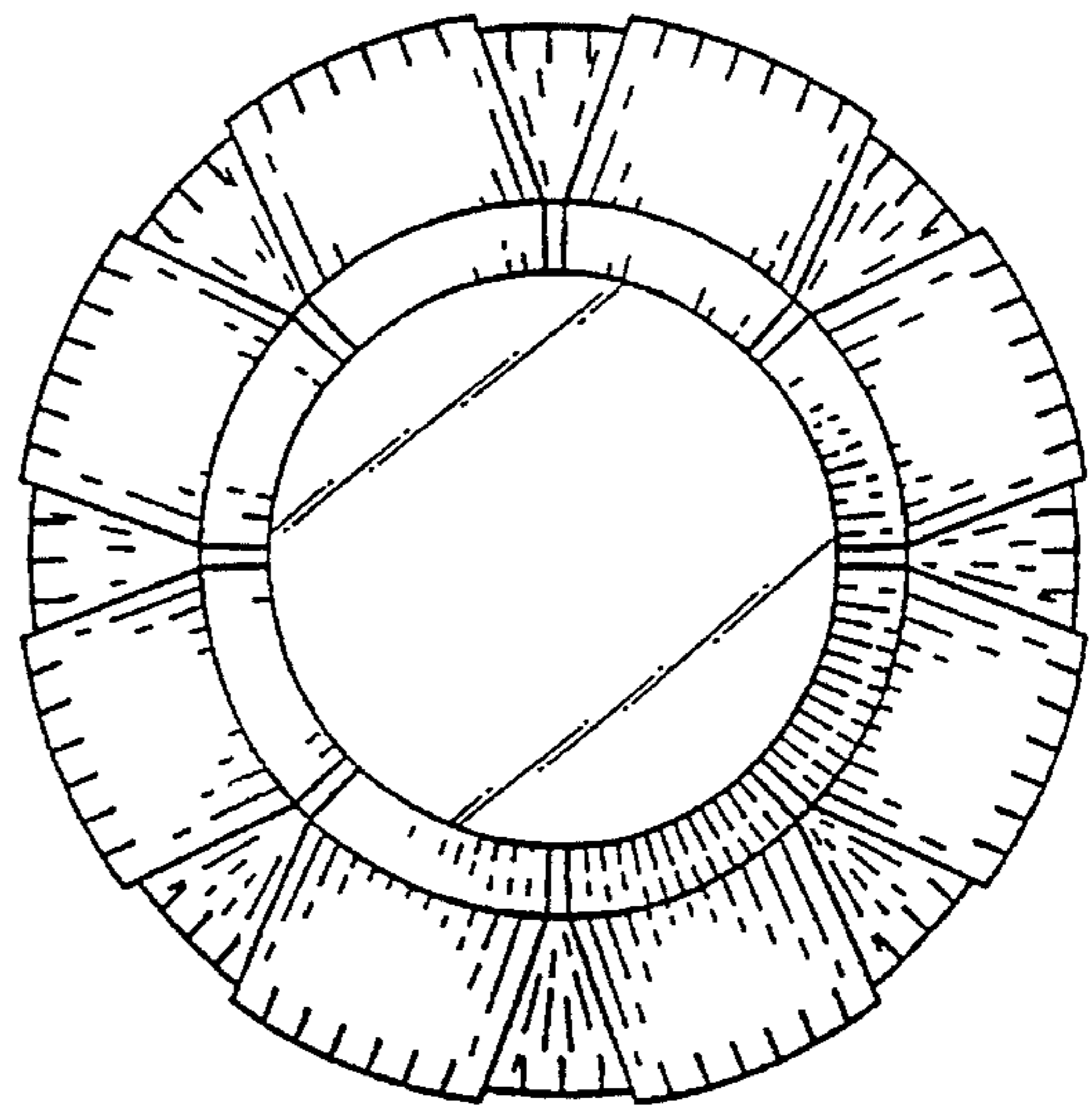

Fig. 4

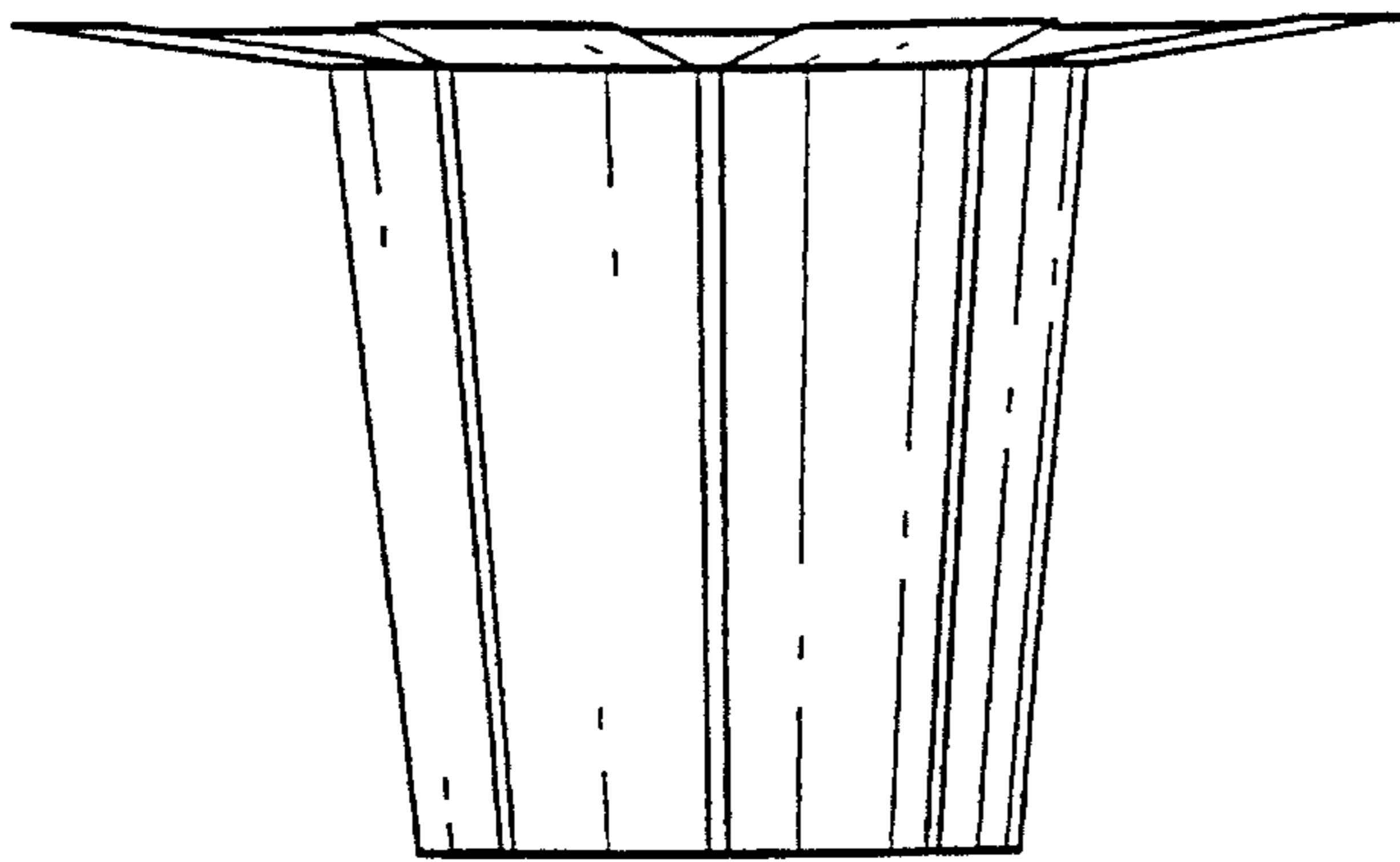

Fig. 5

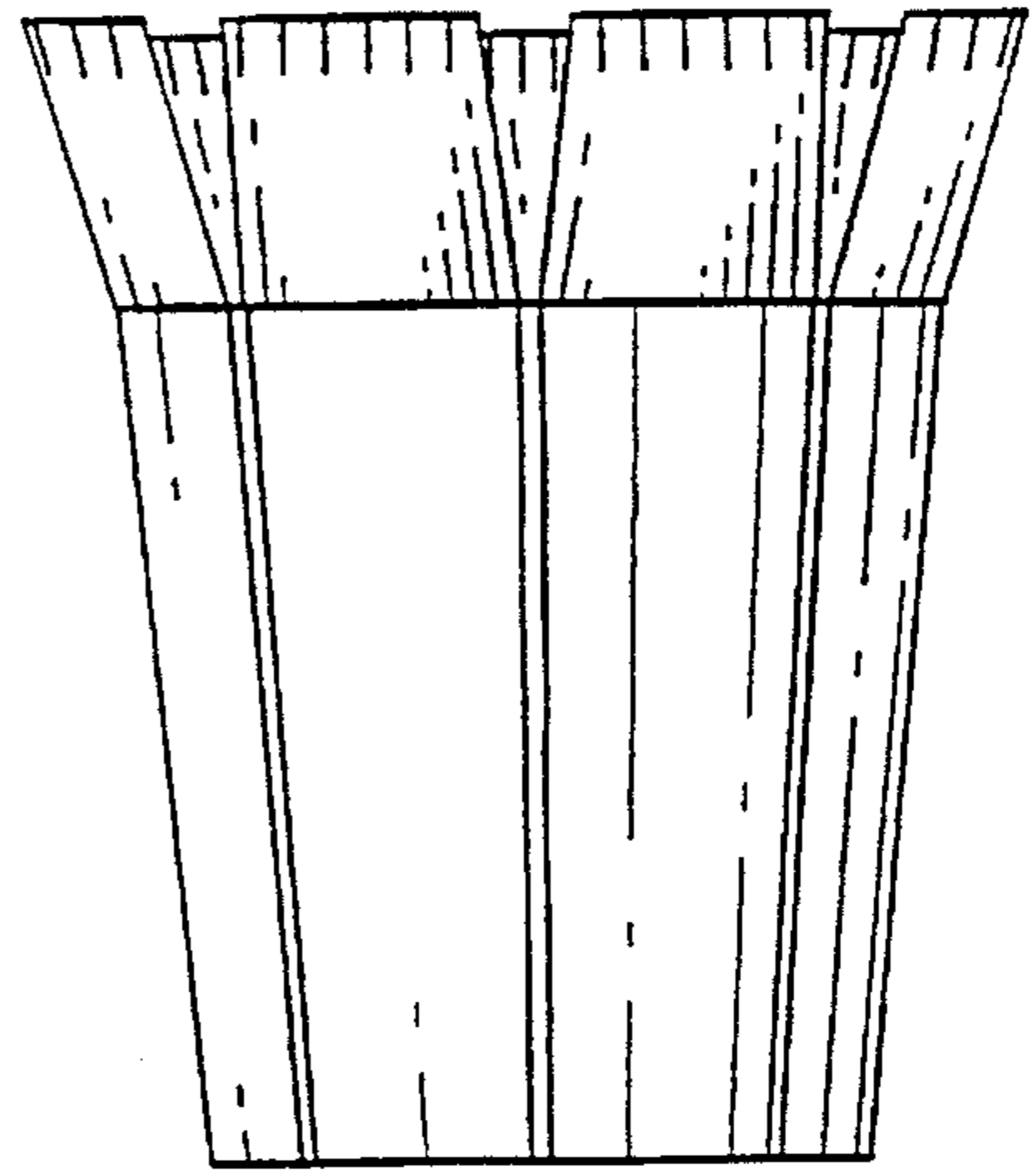

Fig. 6

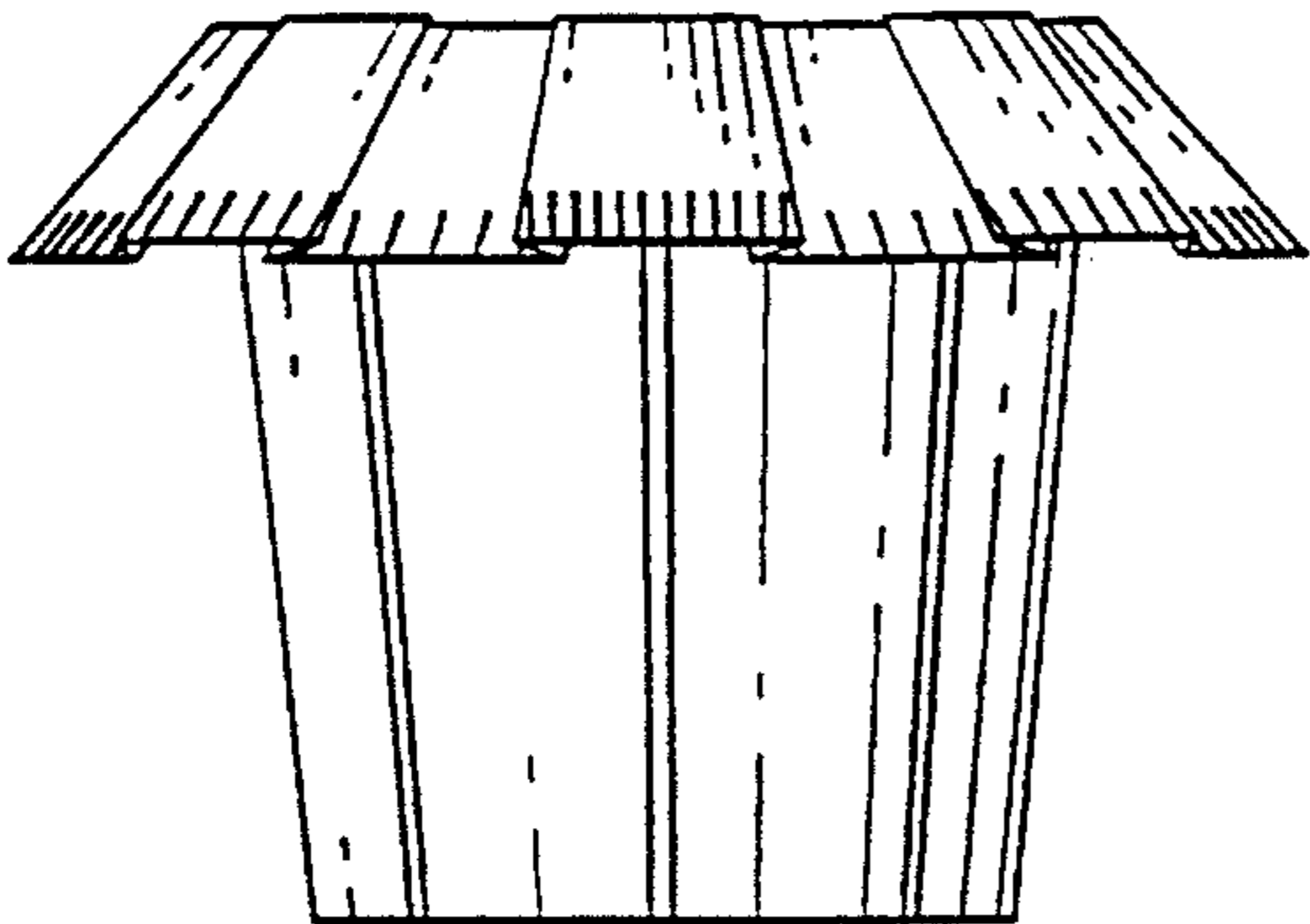

Fig. 7

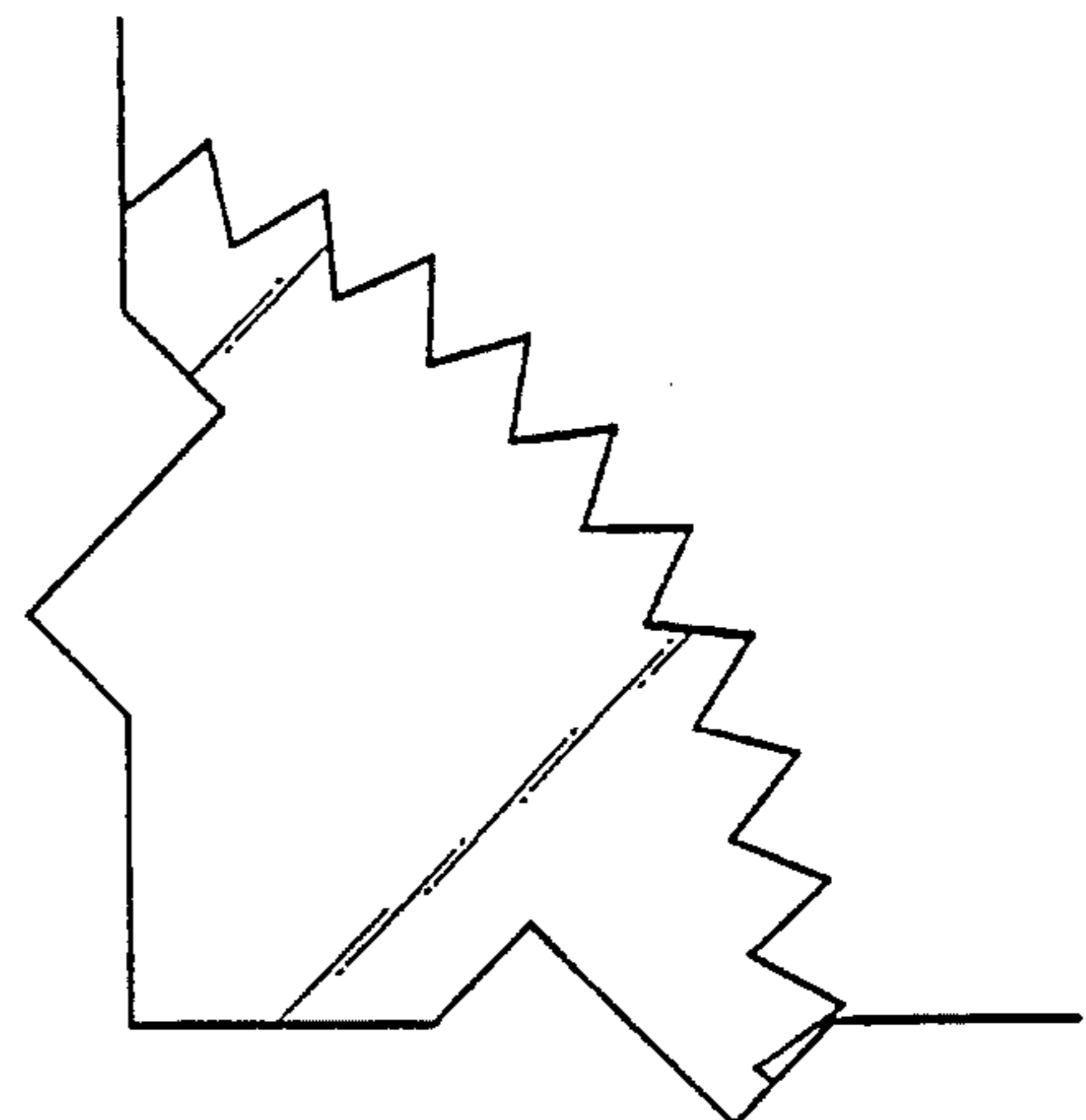

Fig. 8

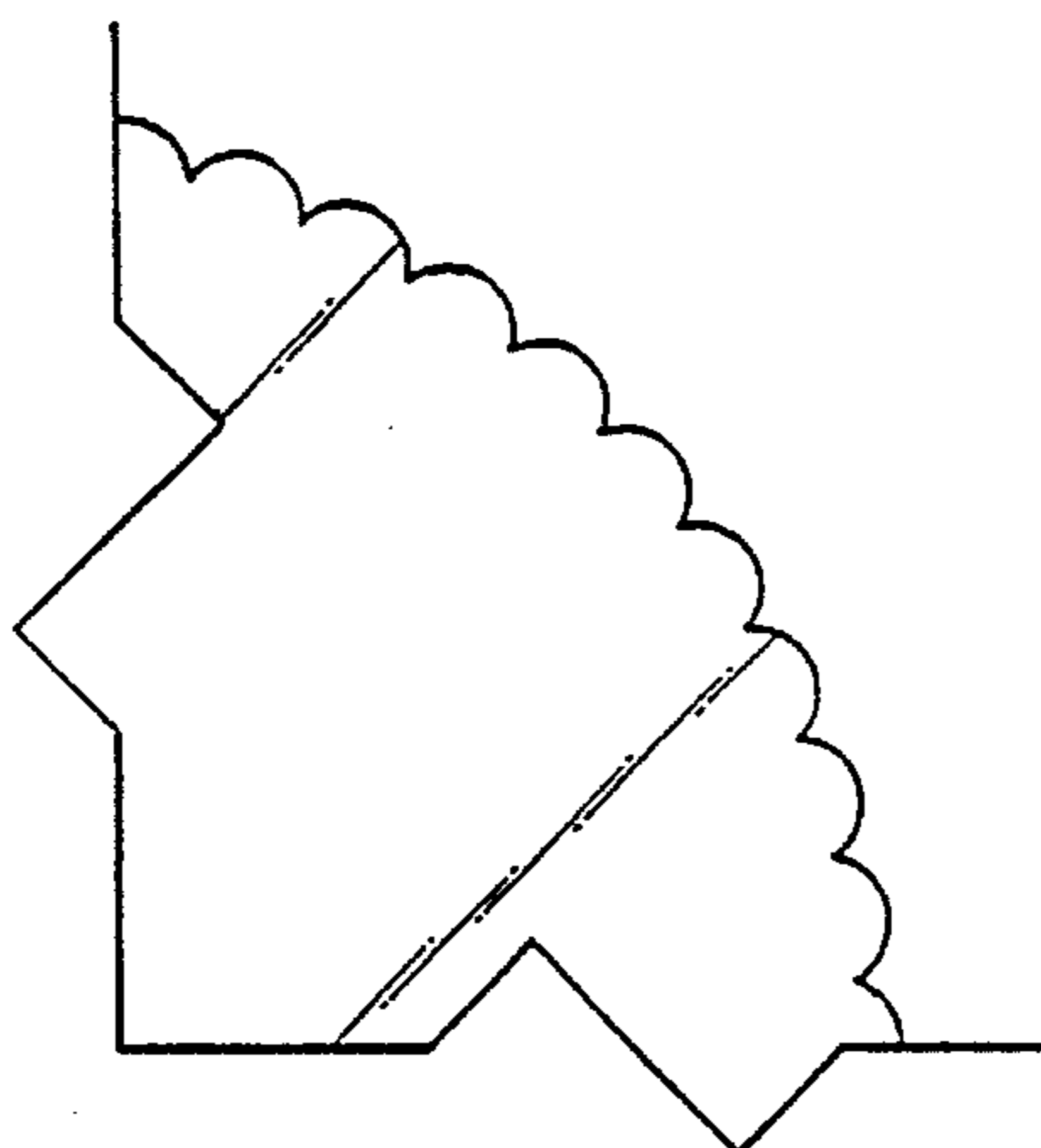

Fig. 9

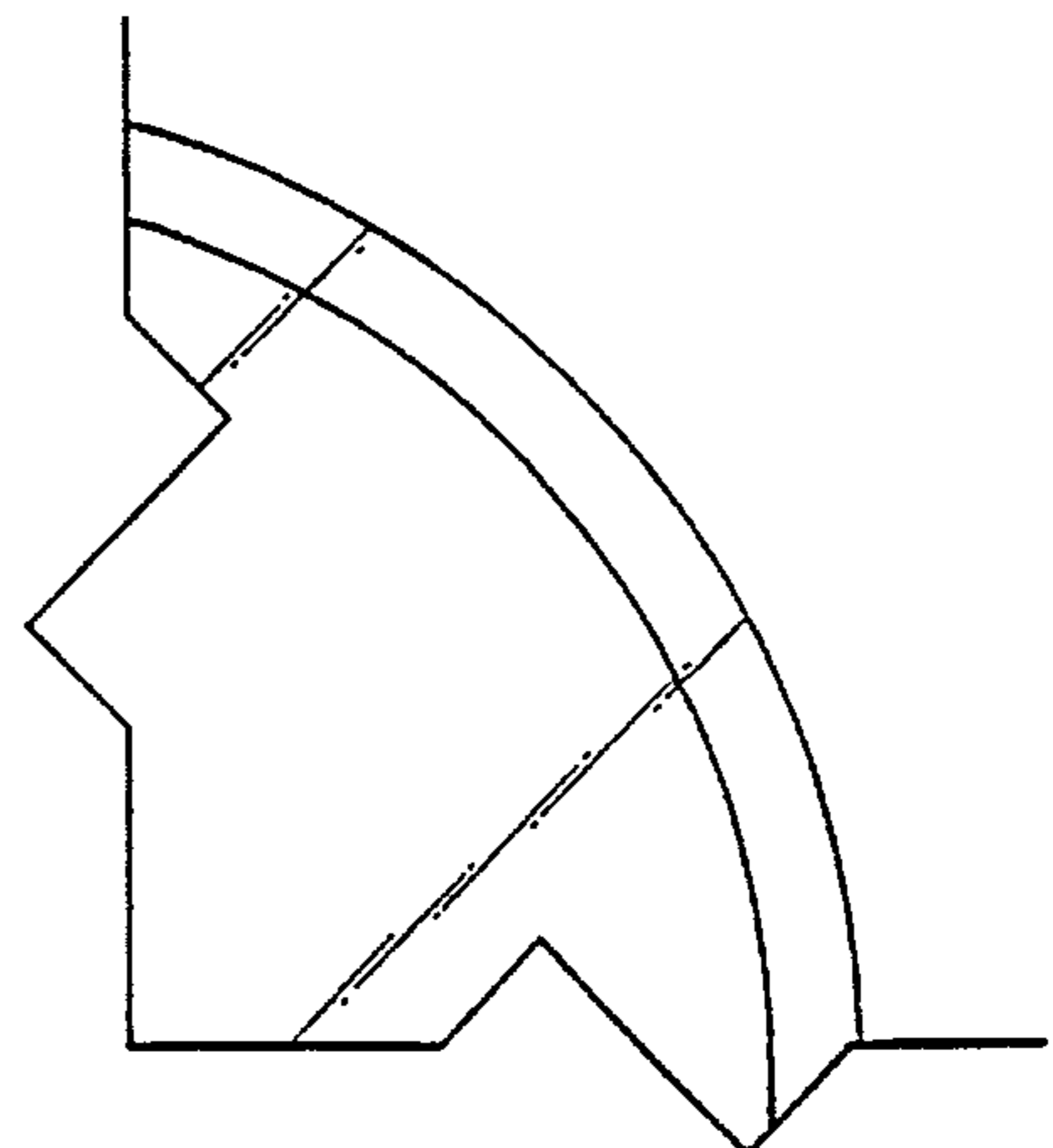

Fig. 10

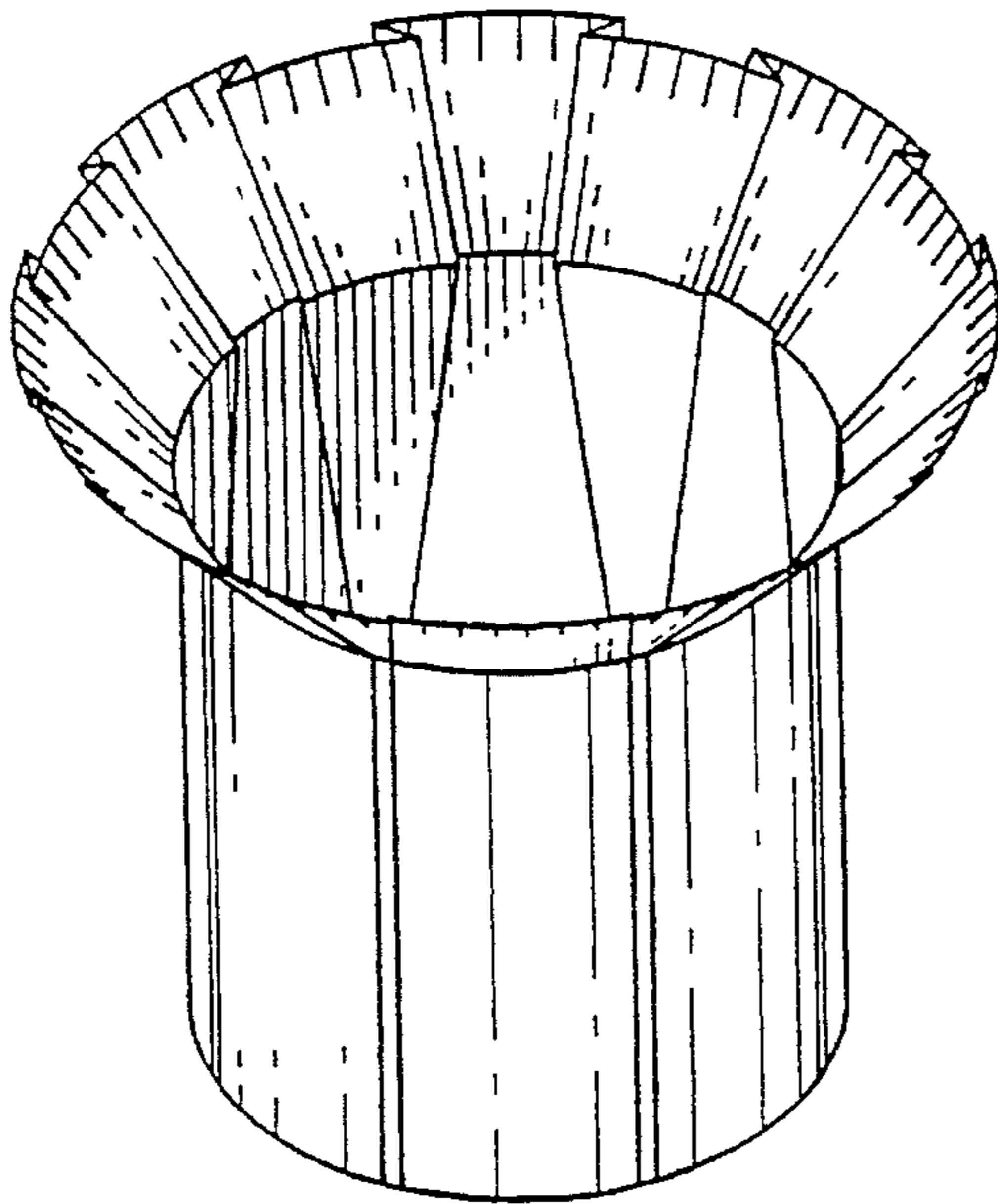

Fig. 11

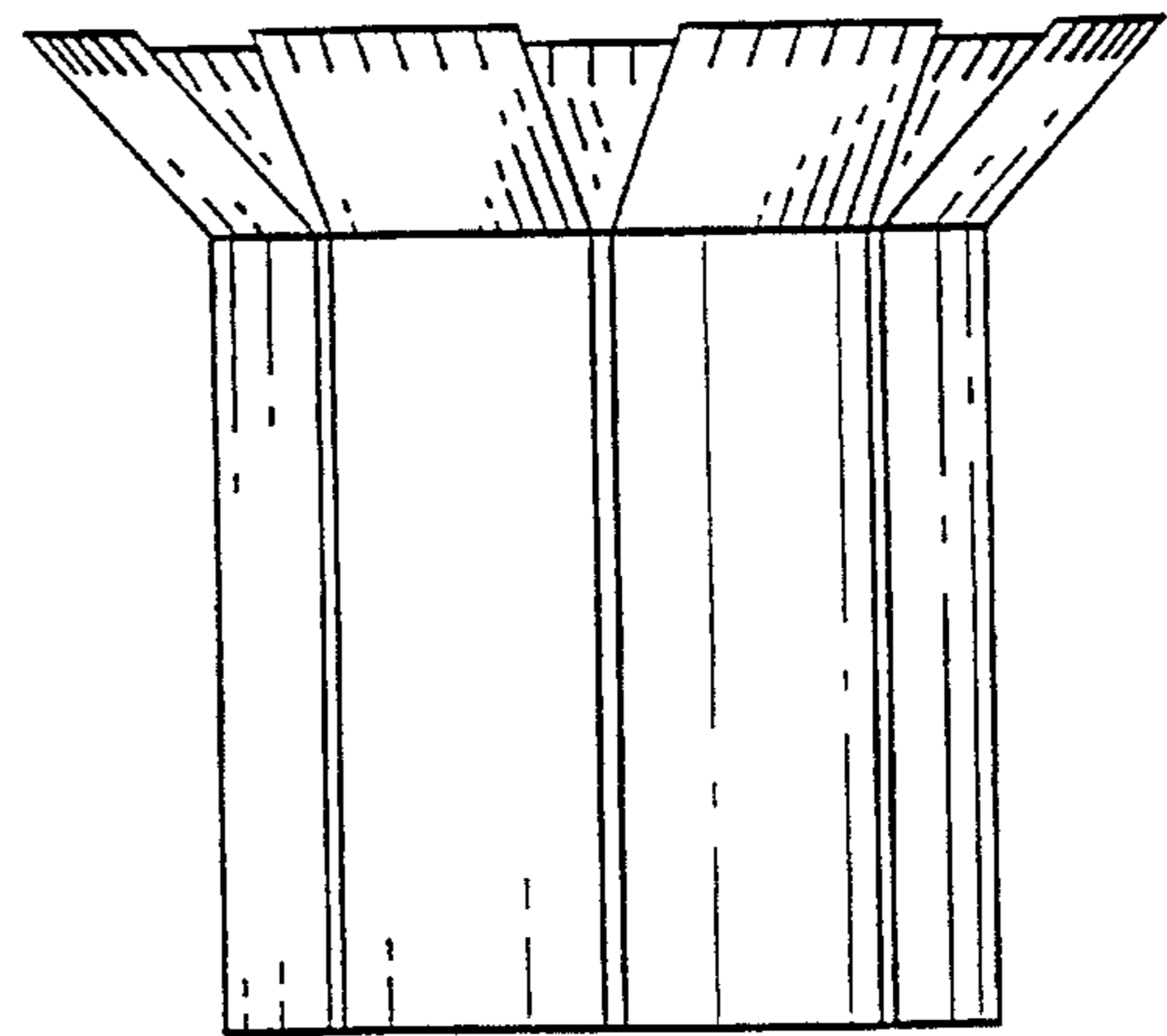

Fig. 12

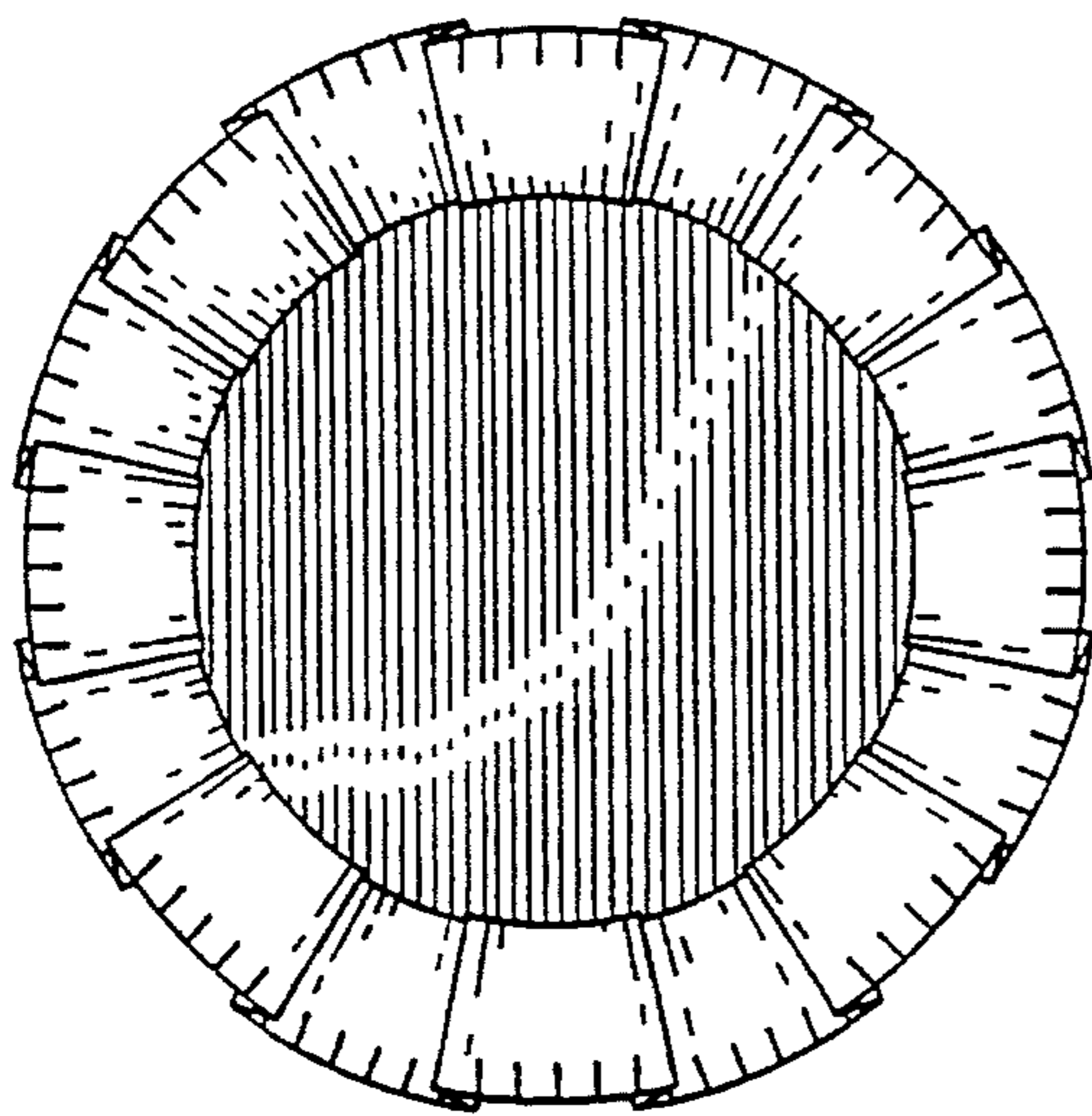

Fig. 13

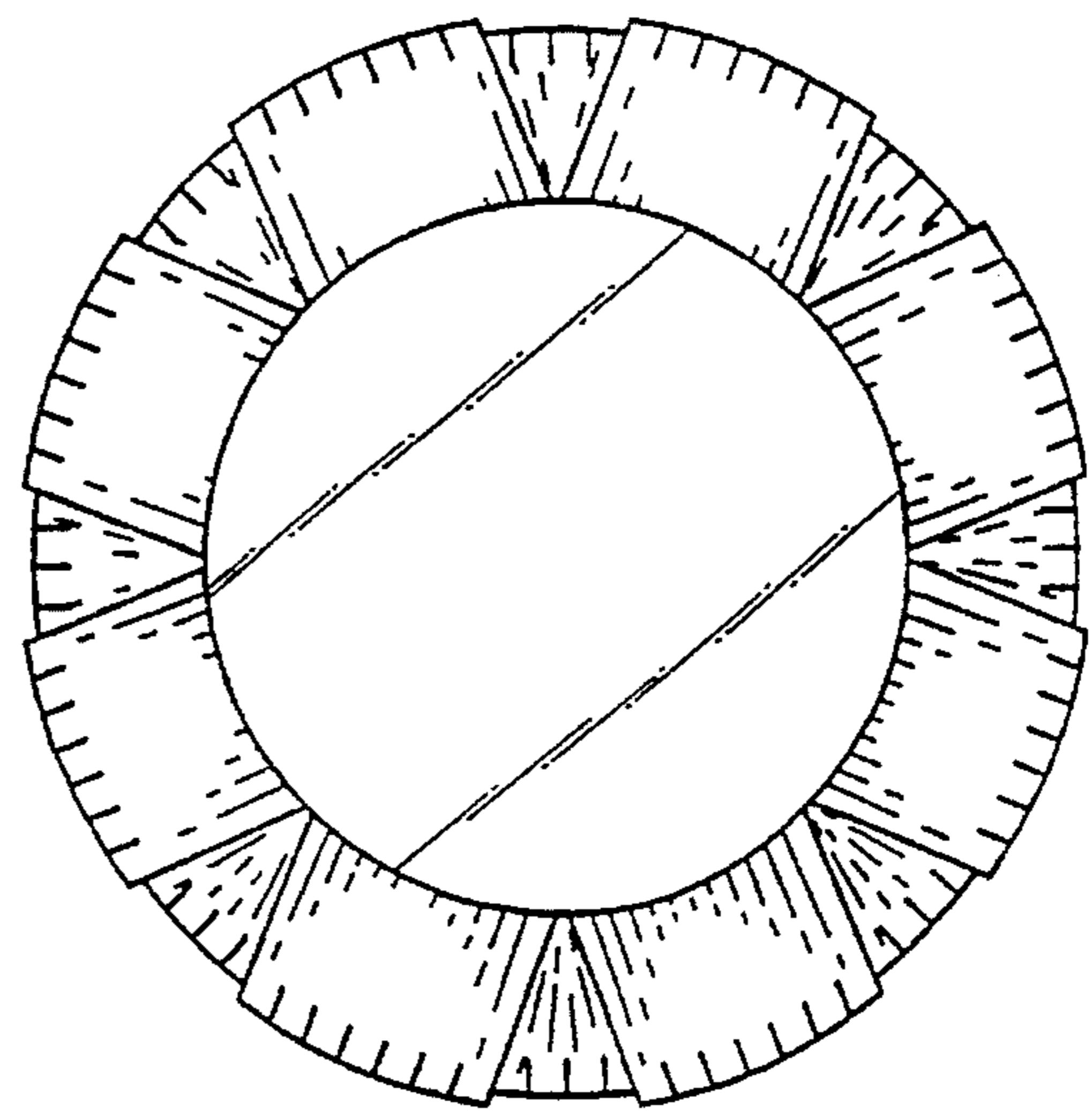

Fig. 14

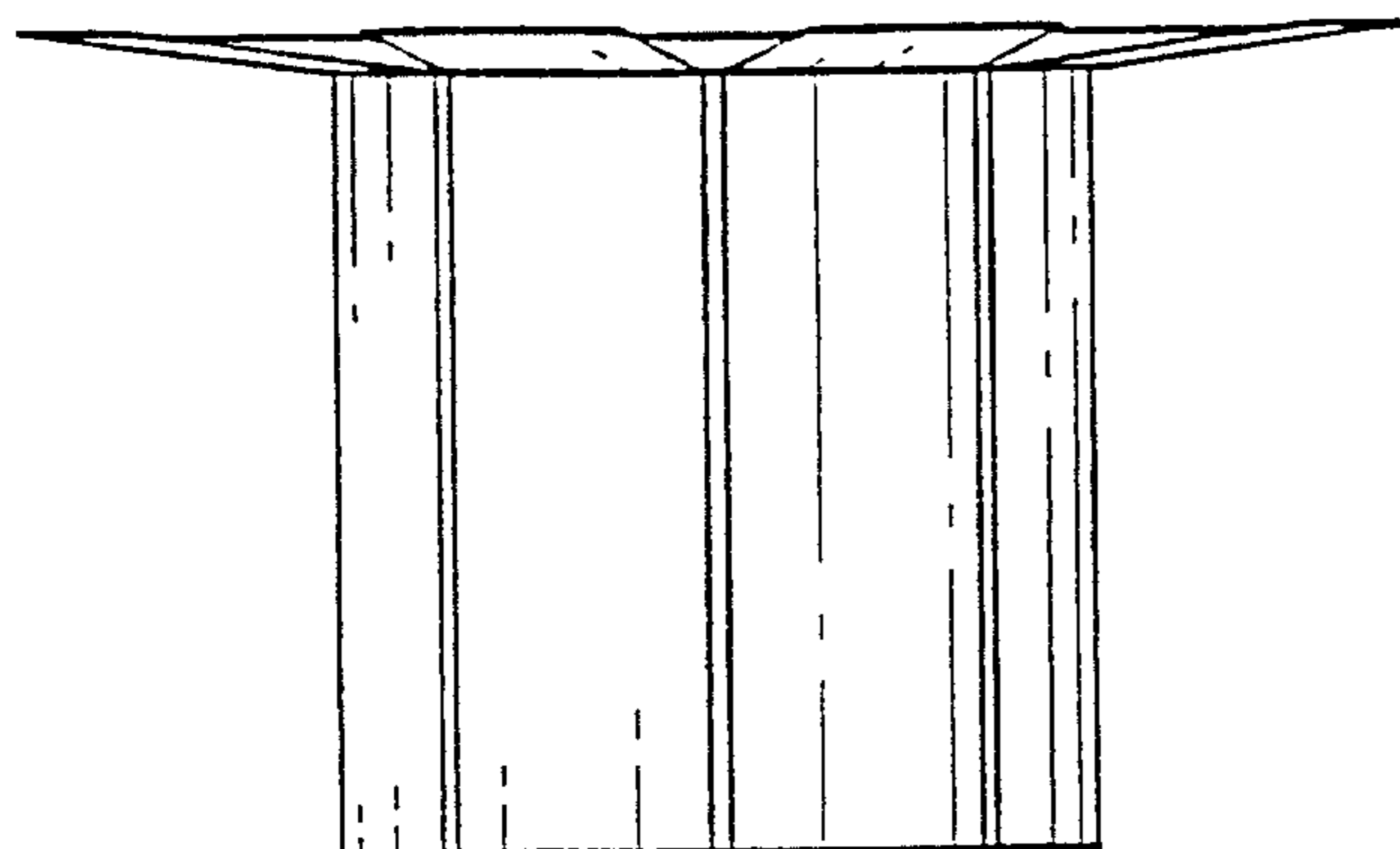

Fig. 15

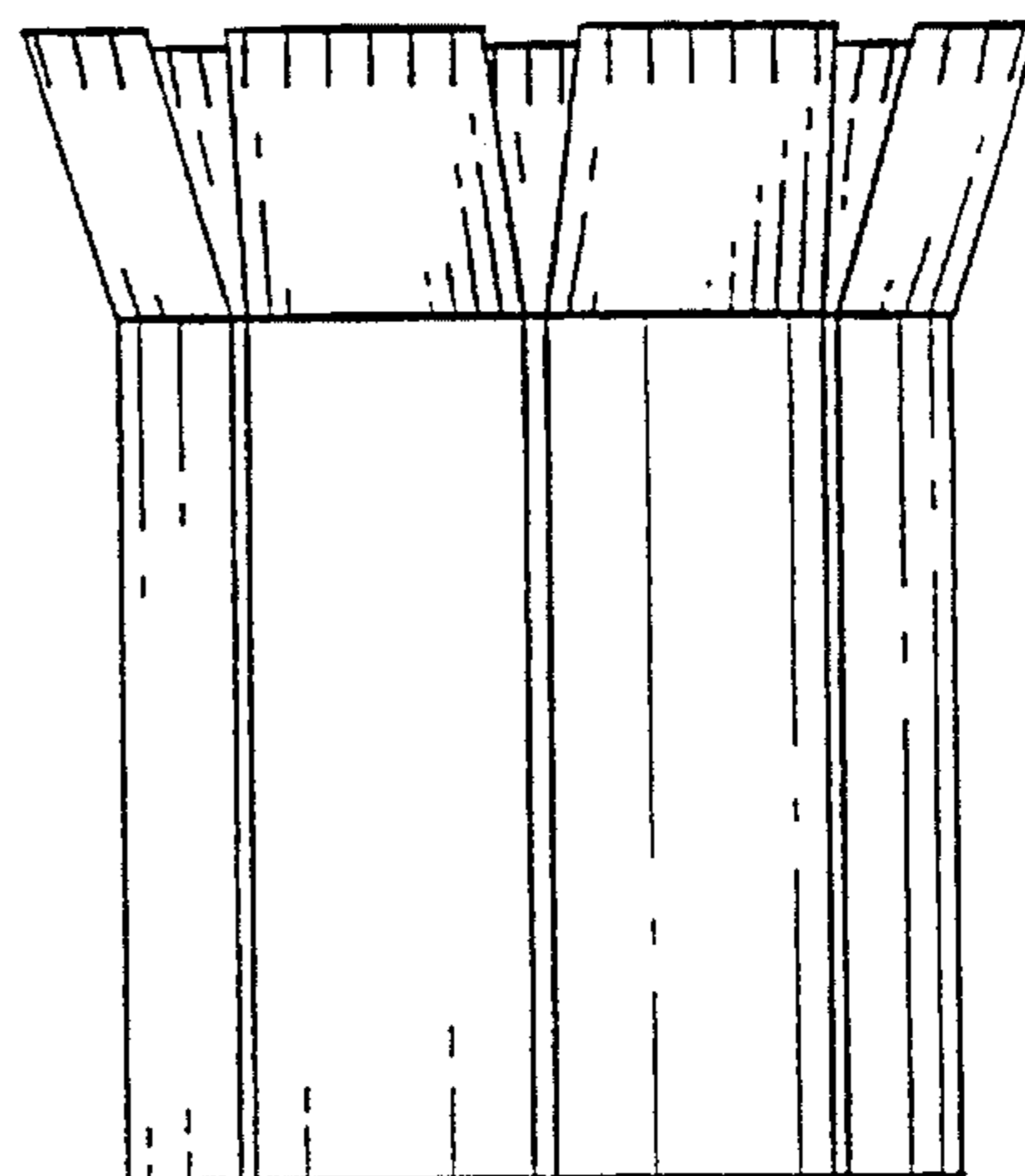

Fig. 16

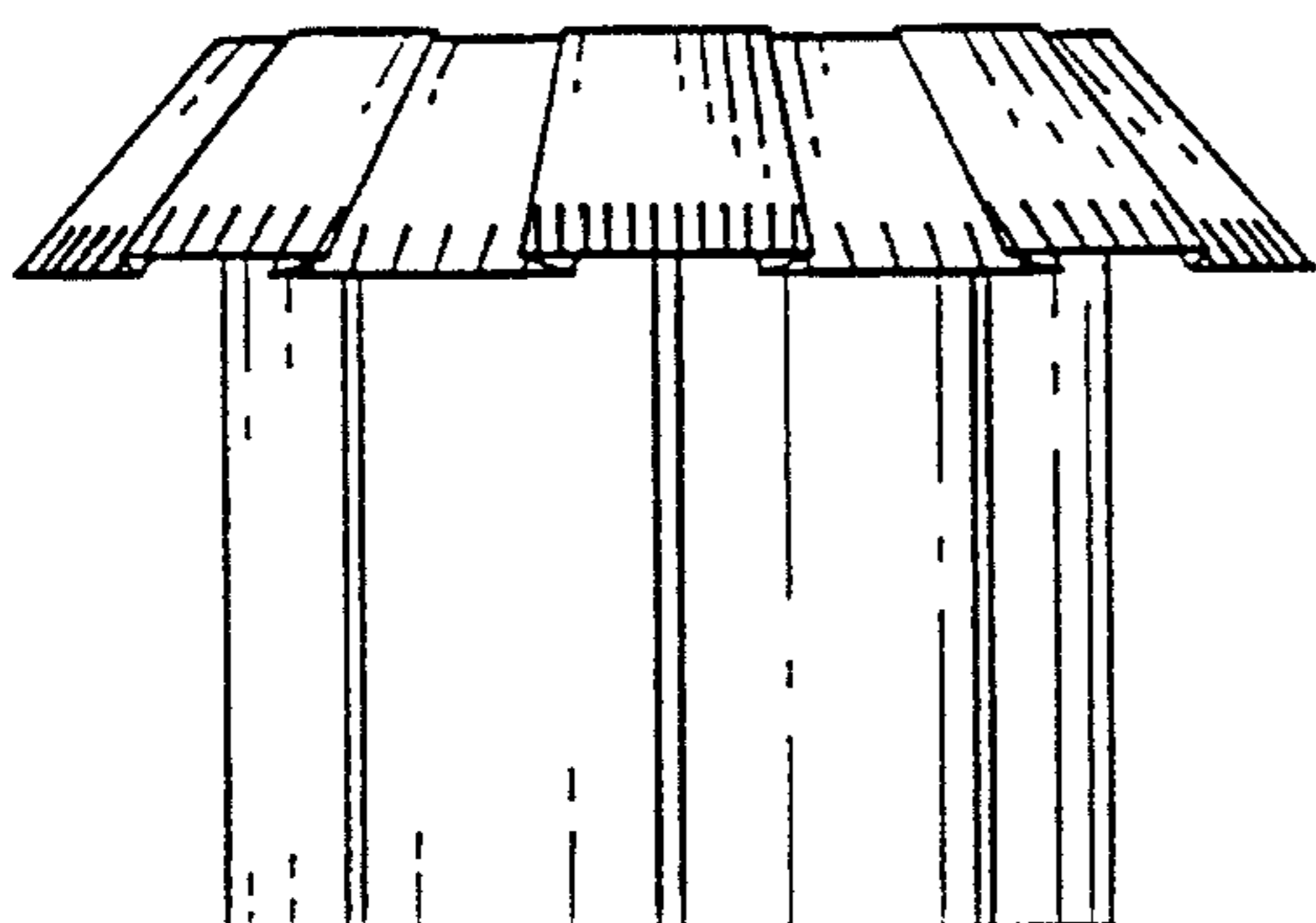

Fig. 17

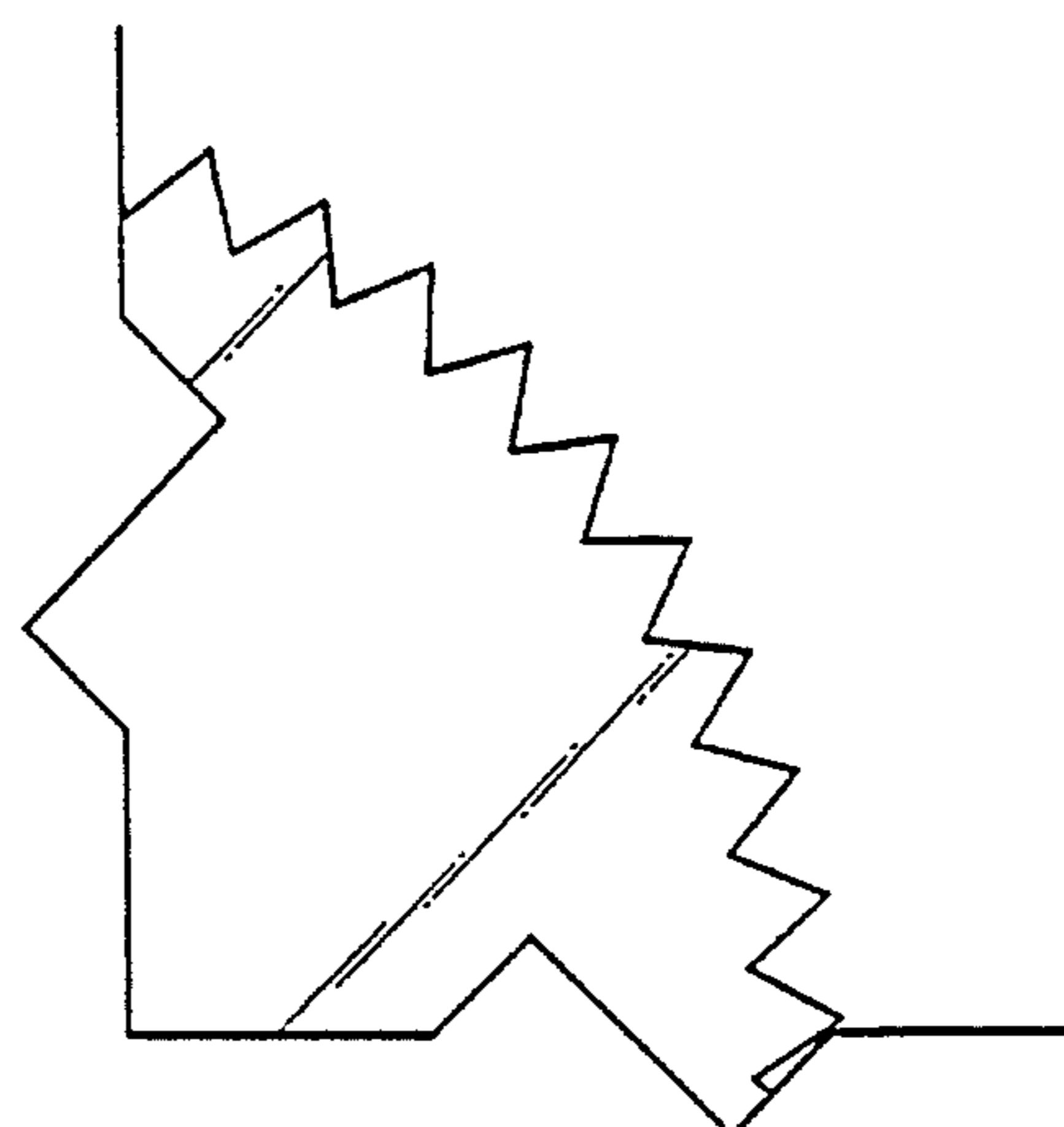

Fig. 18

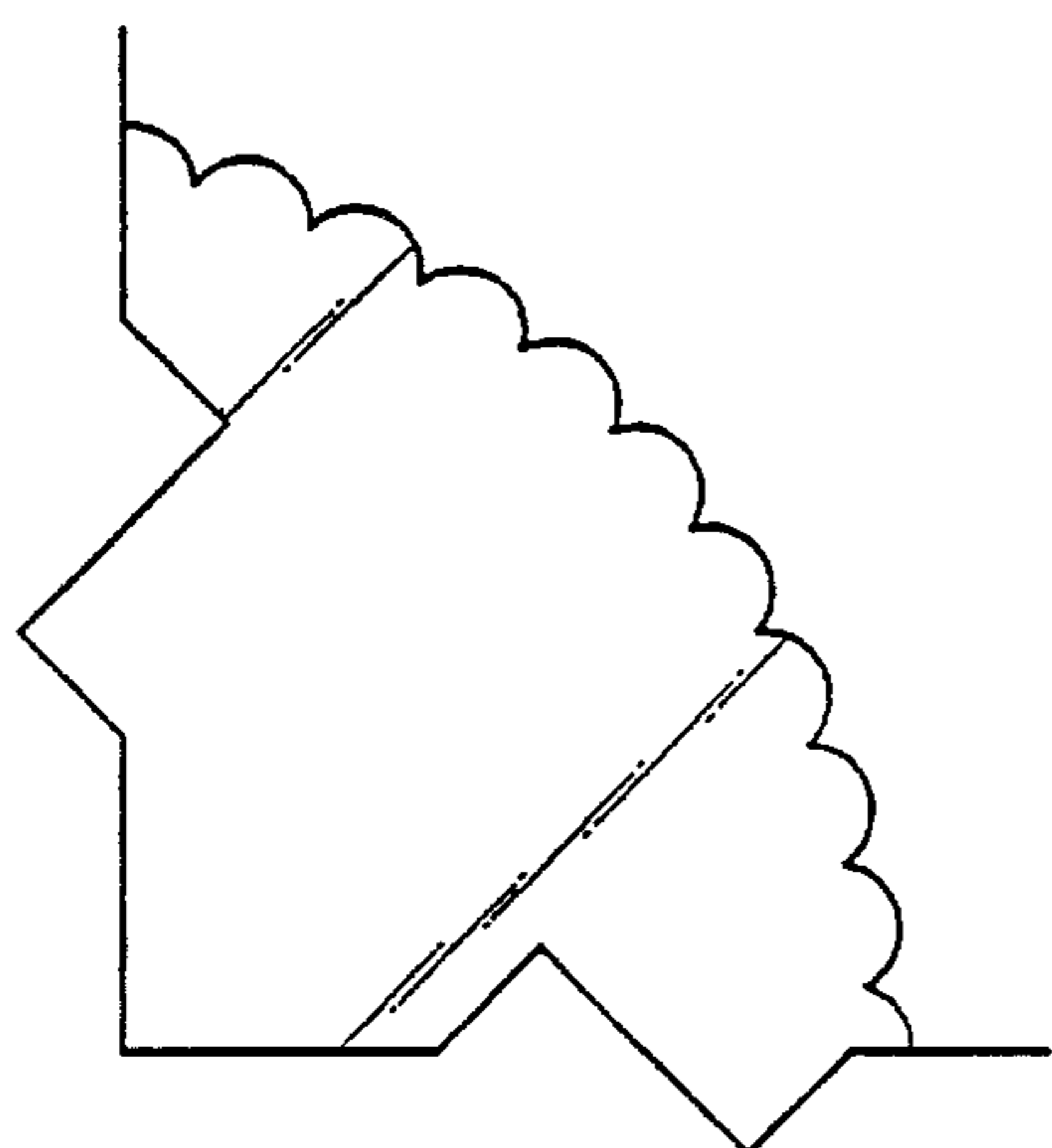

Fig. 19

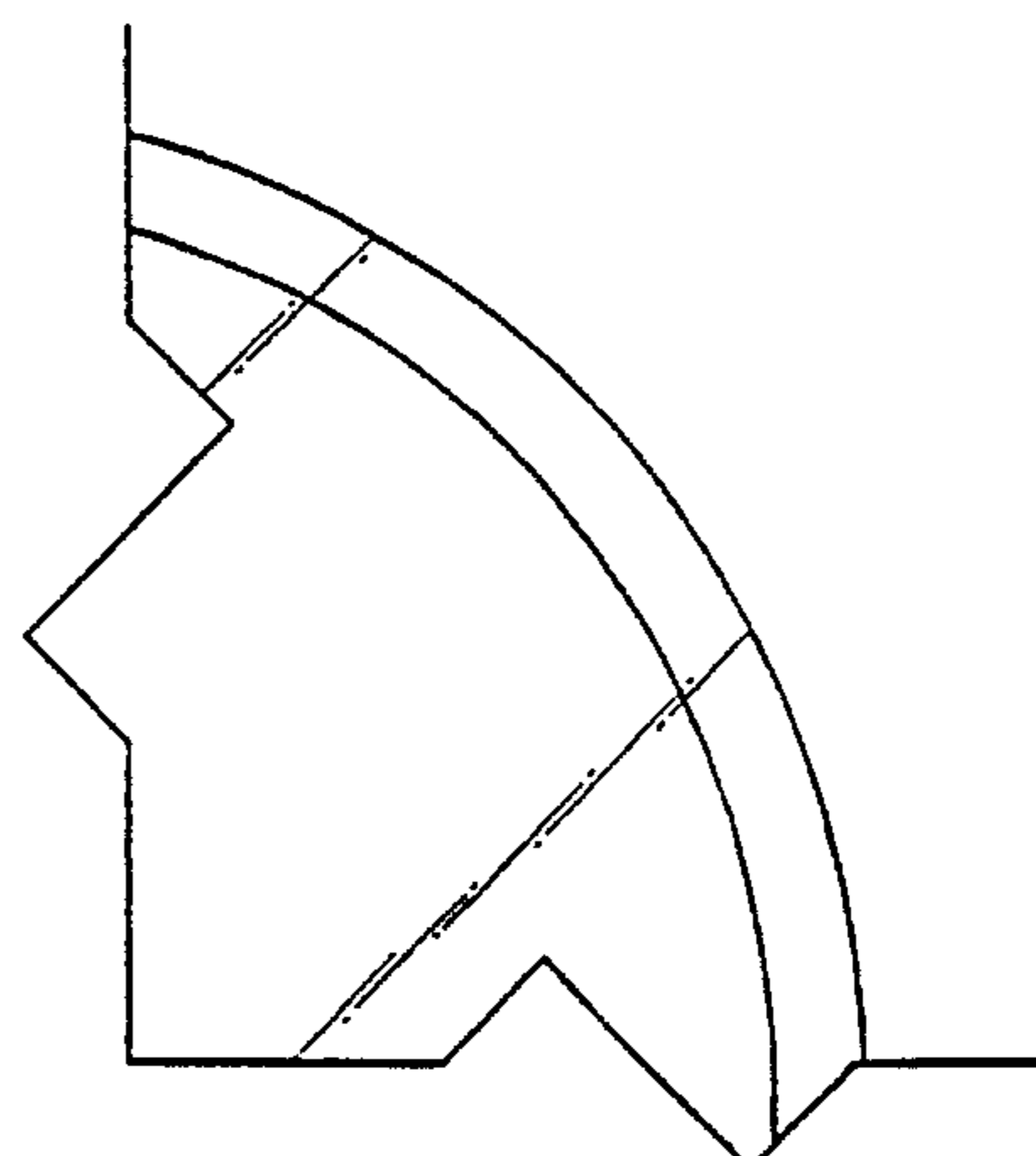

Fig. 20

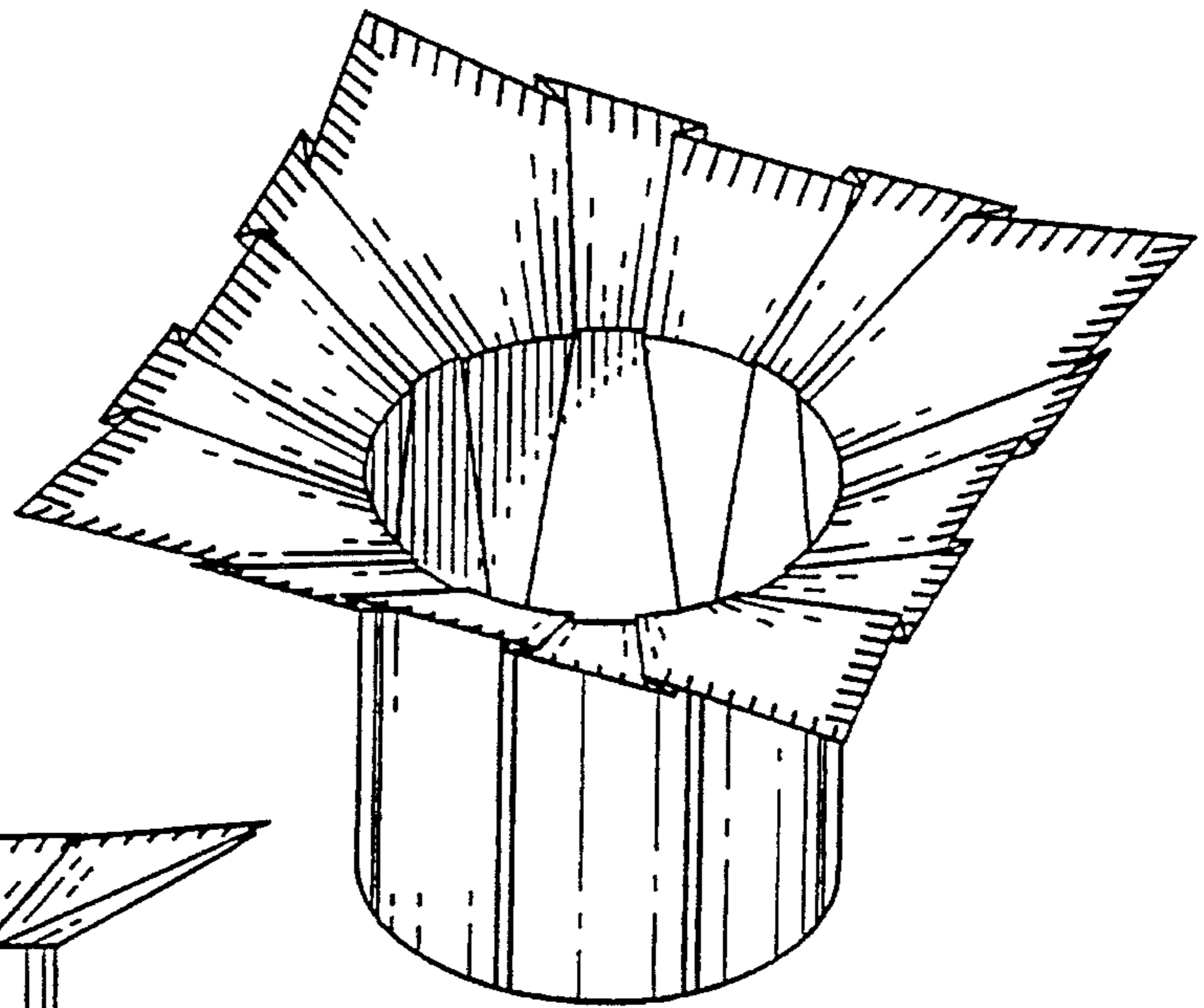

Fig. 21

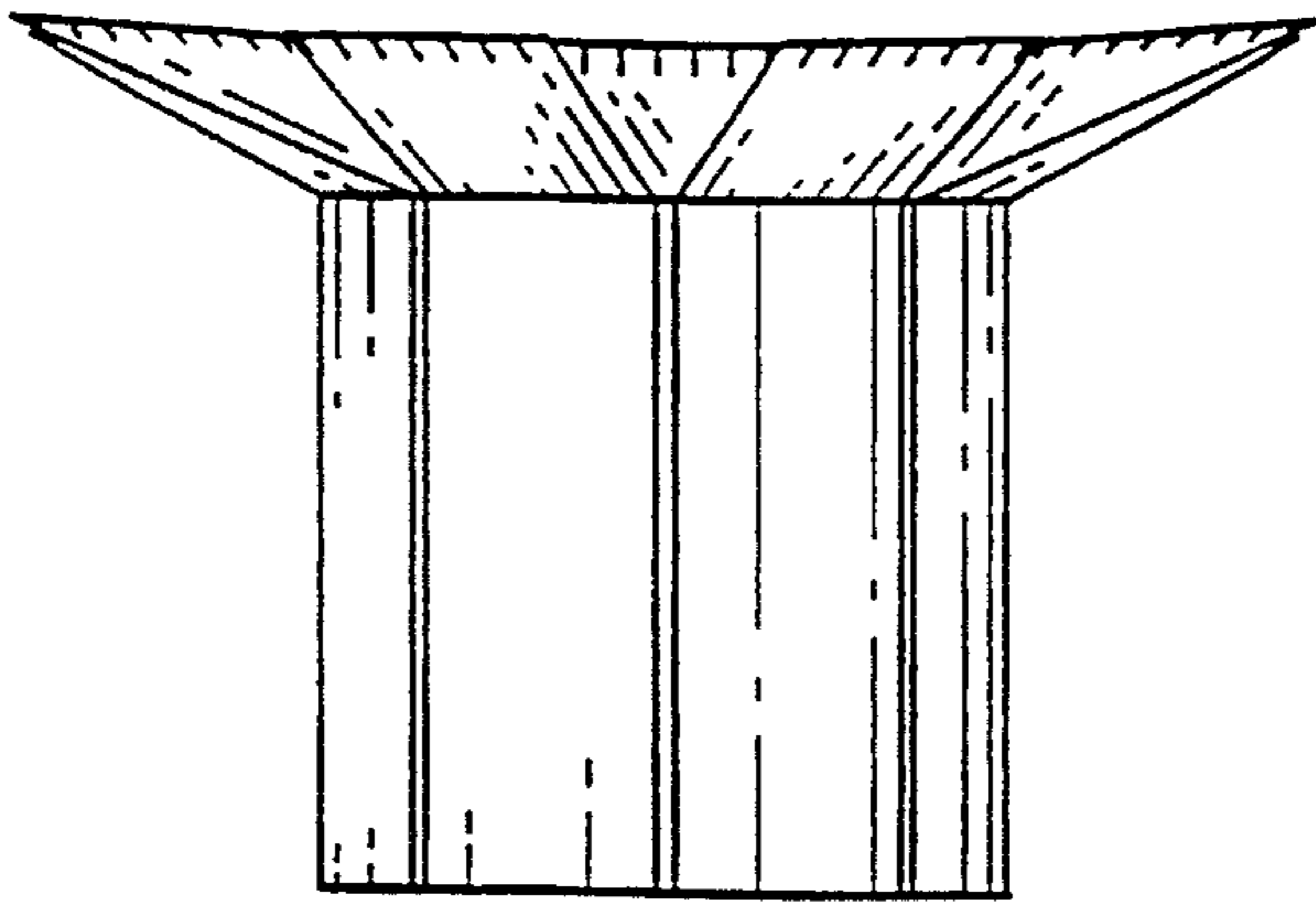

Fig. 22

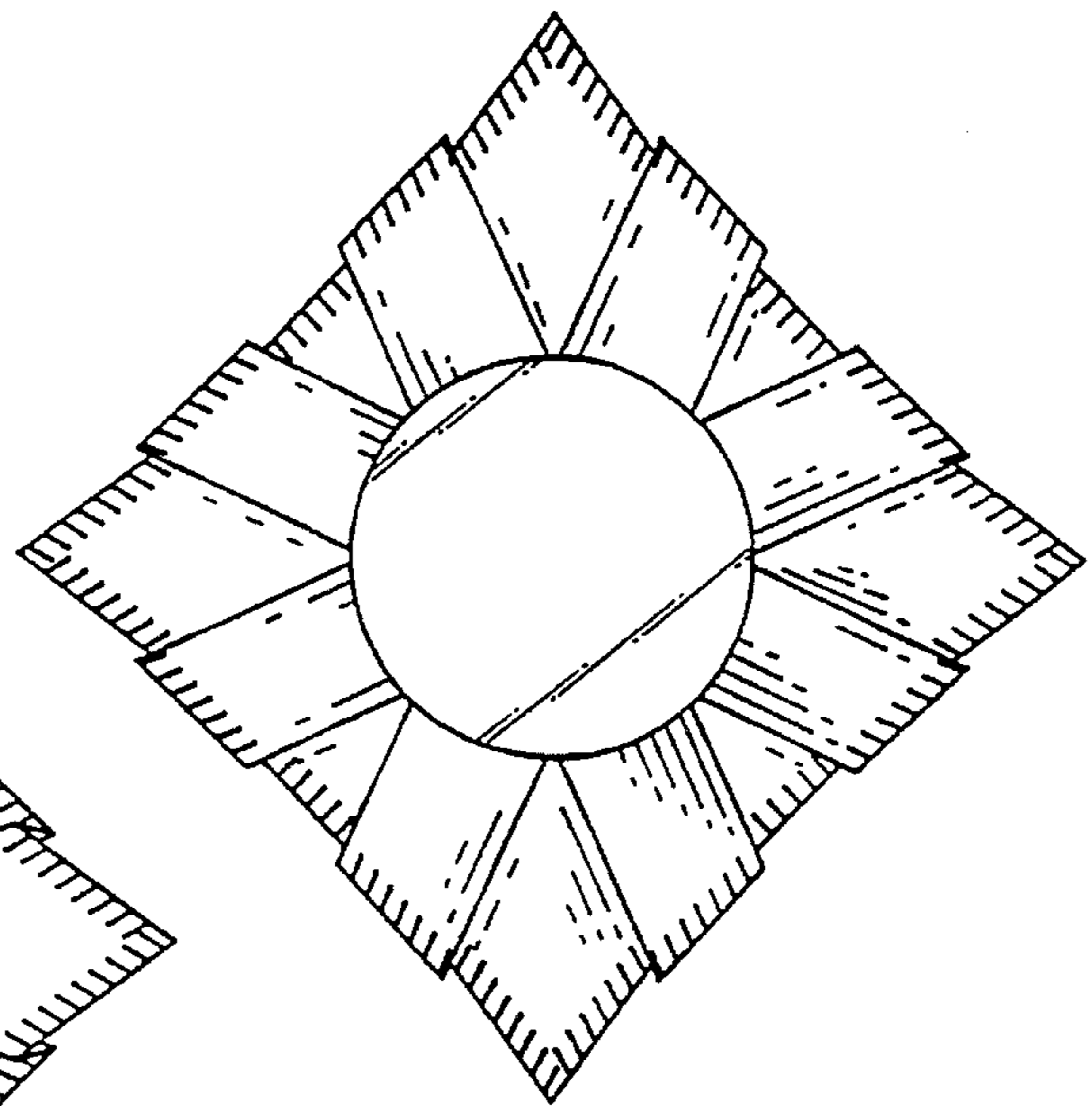

Fig. 24

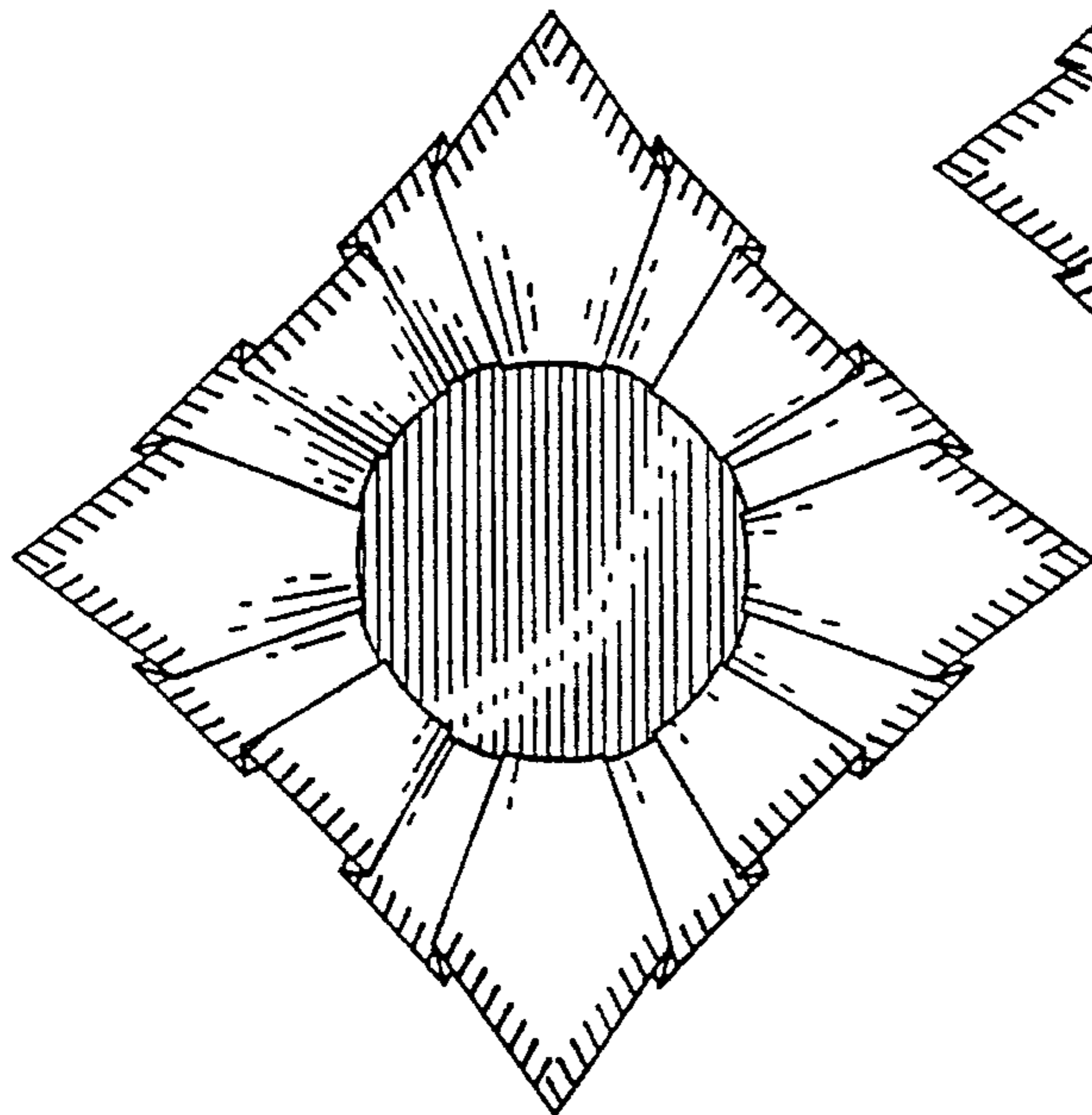

Fig. 23

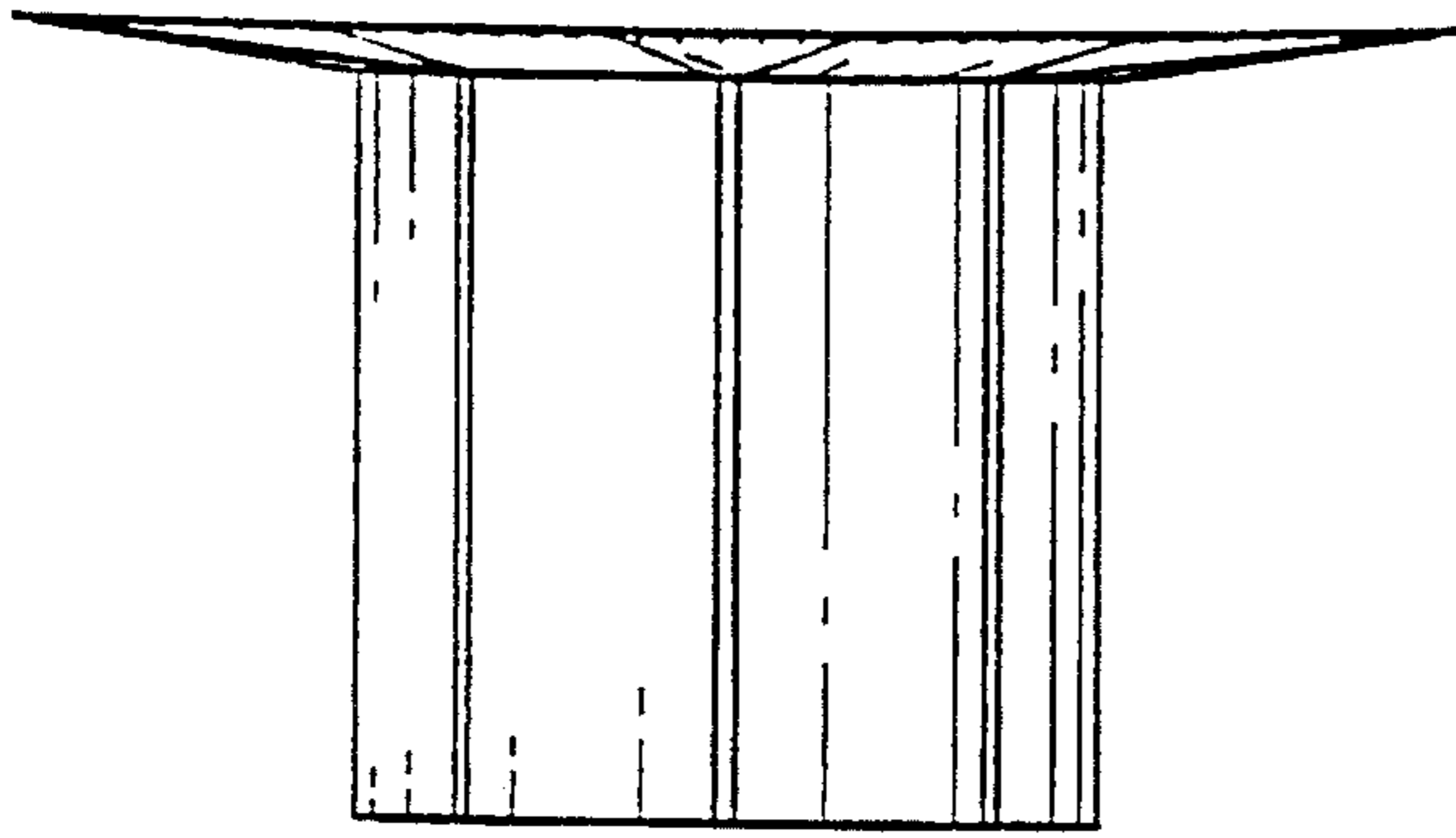

Fig. 25

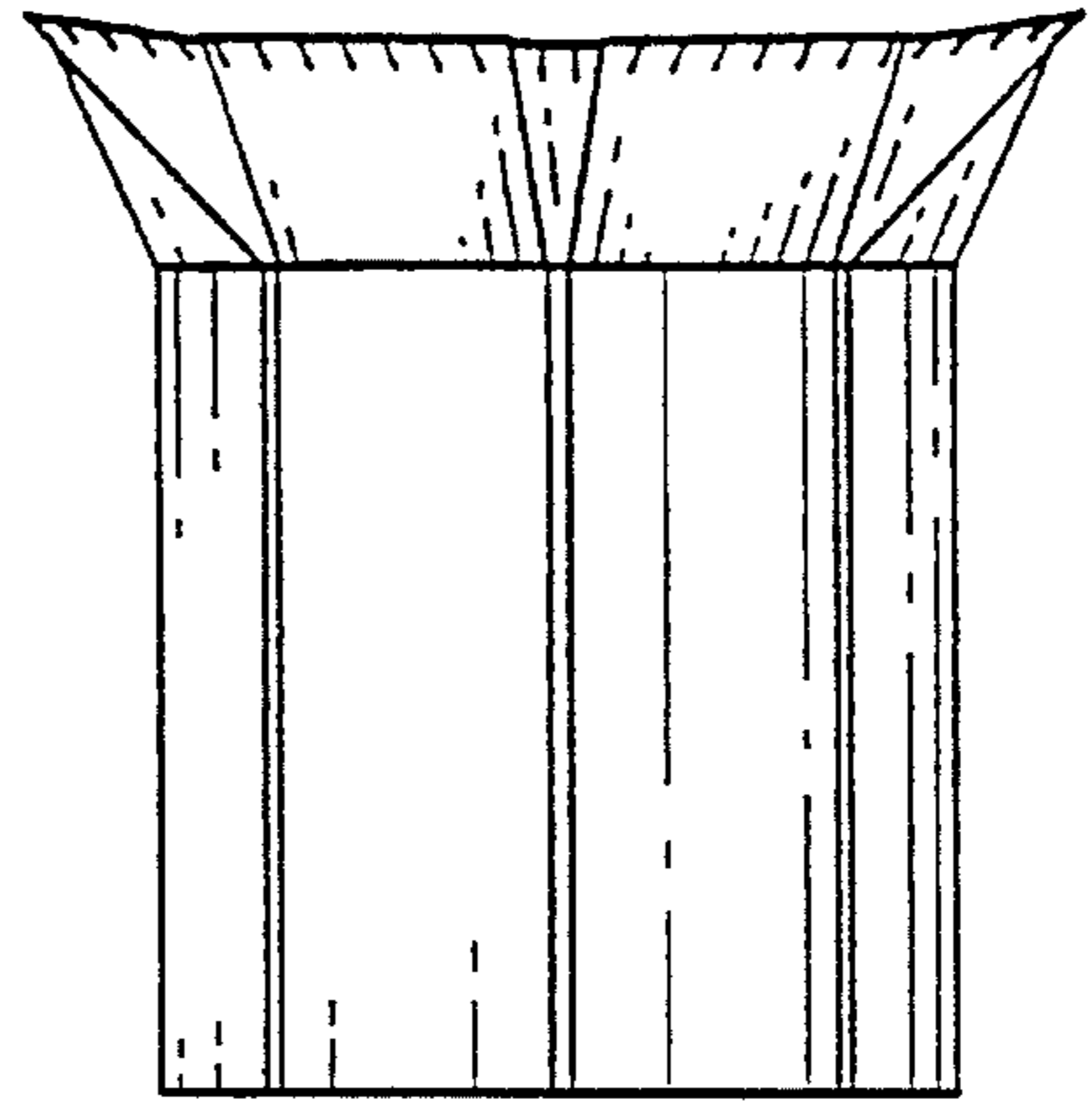

Fig. 26

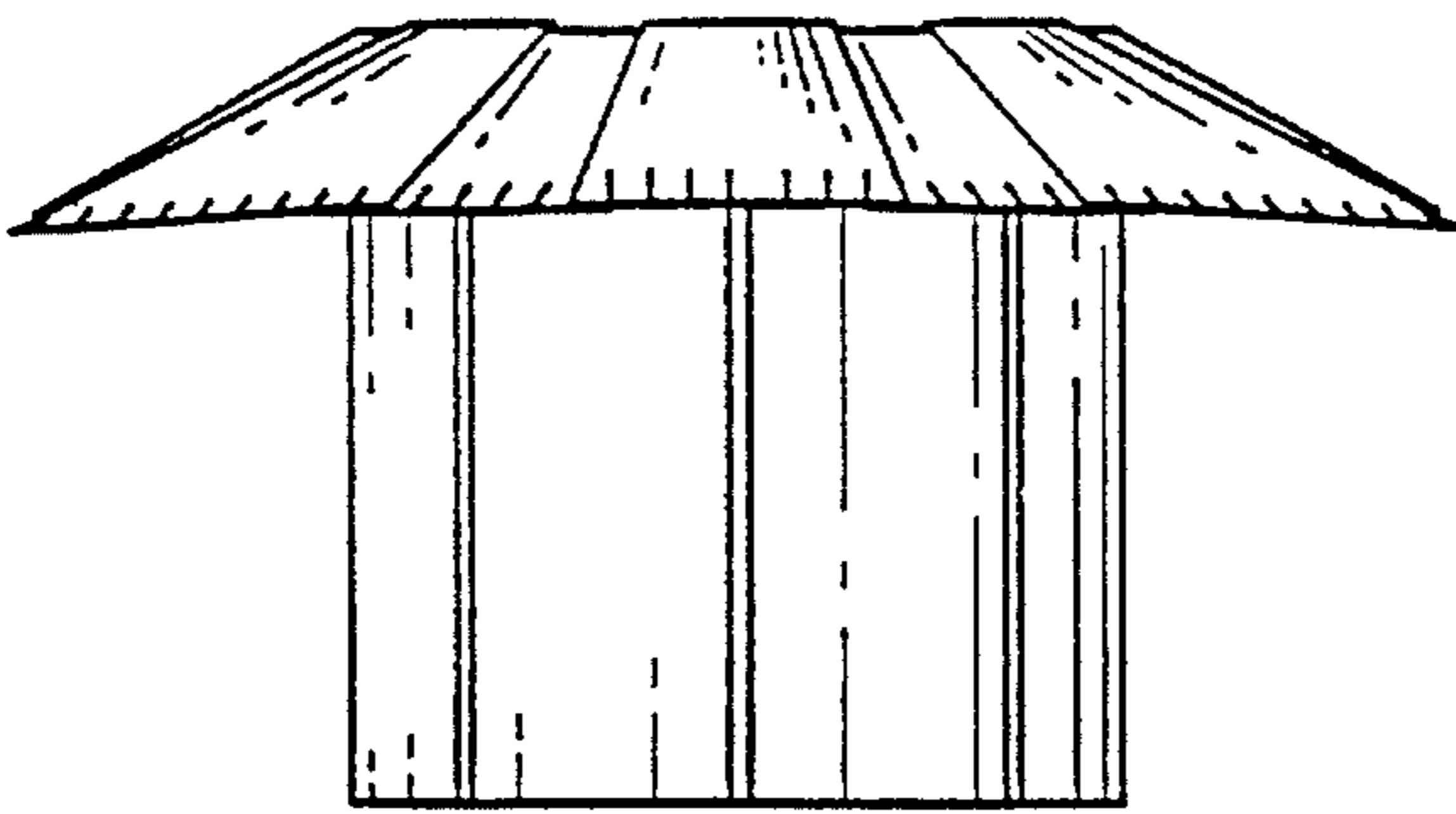

Fig. 27

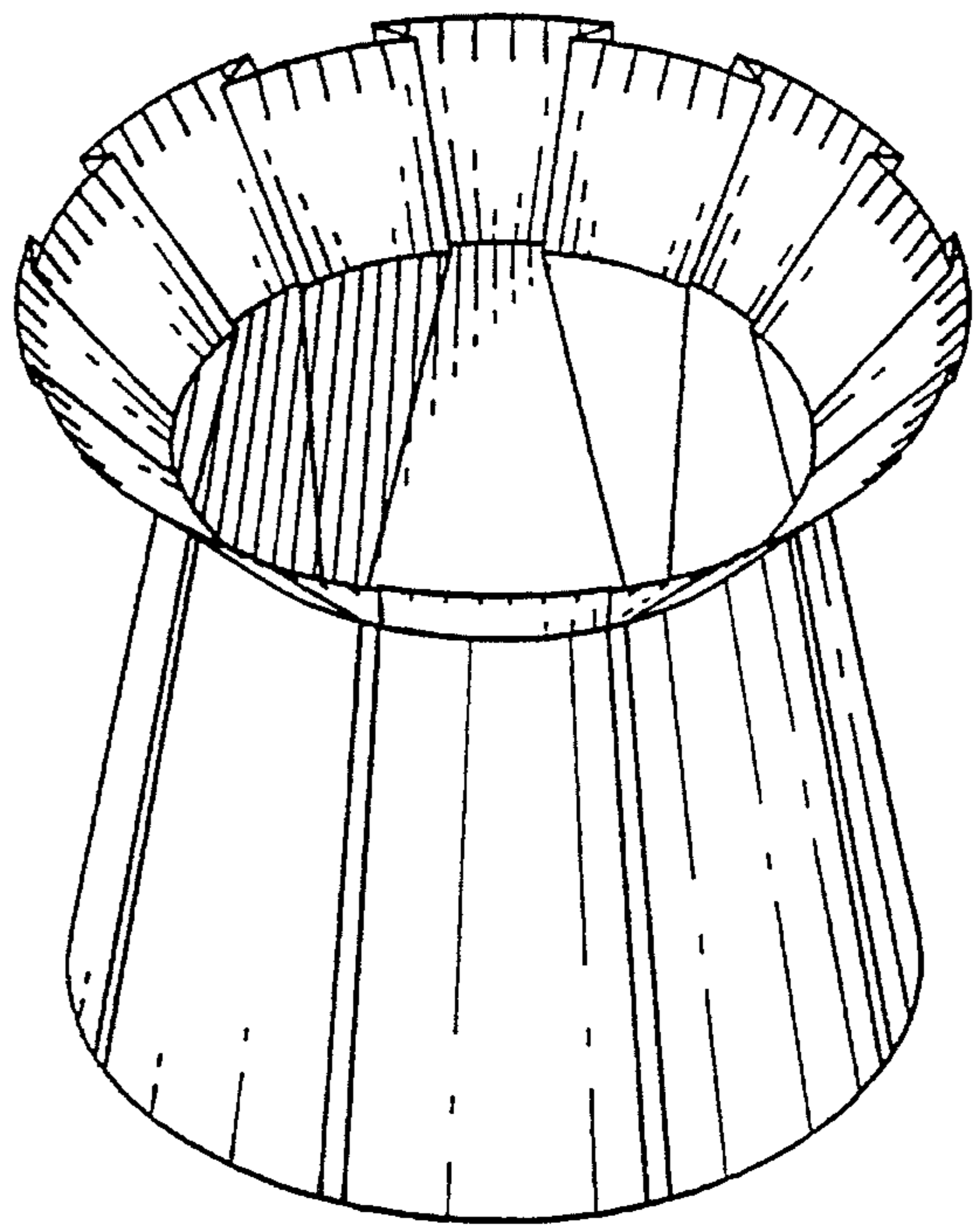

Fig. 28

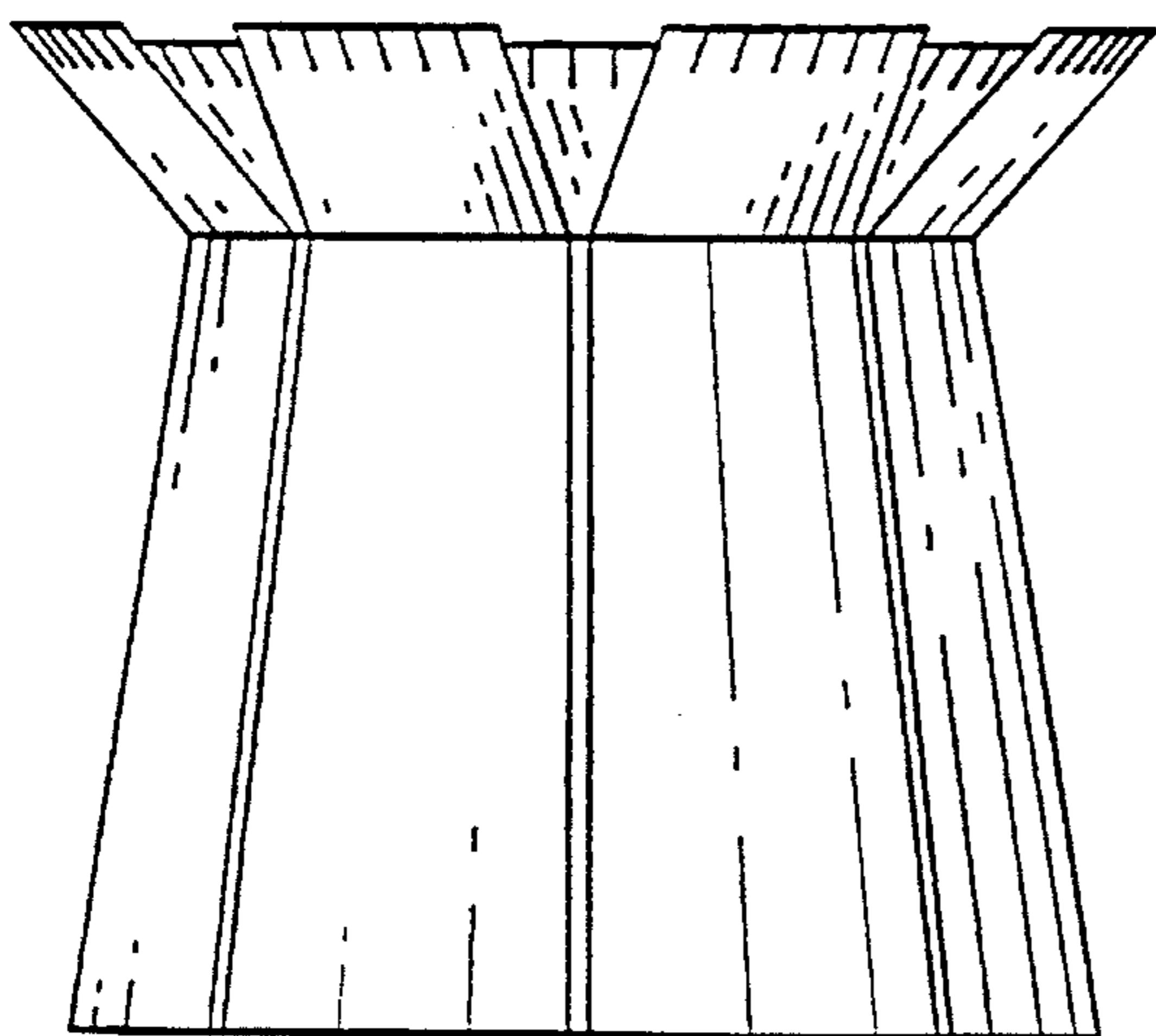

Fig. 29

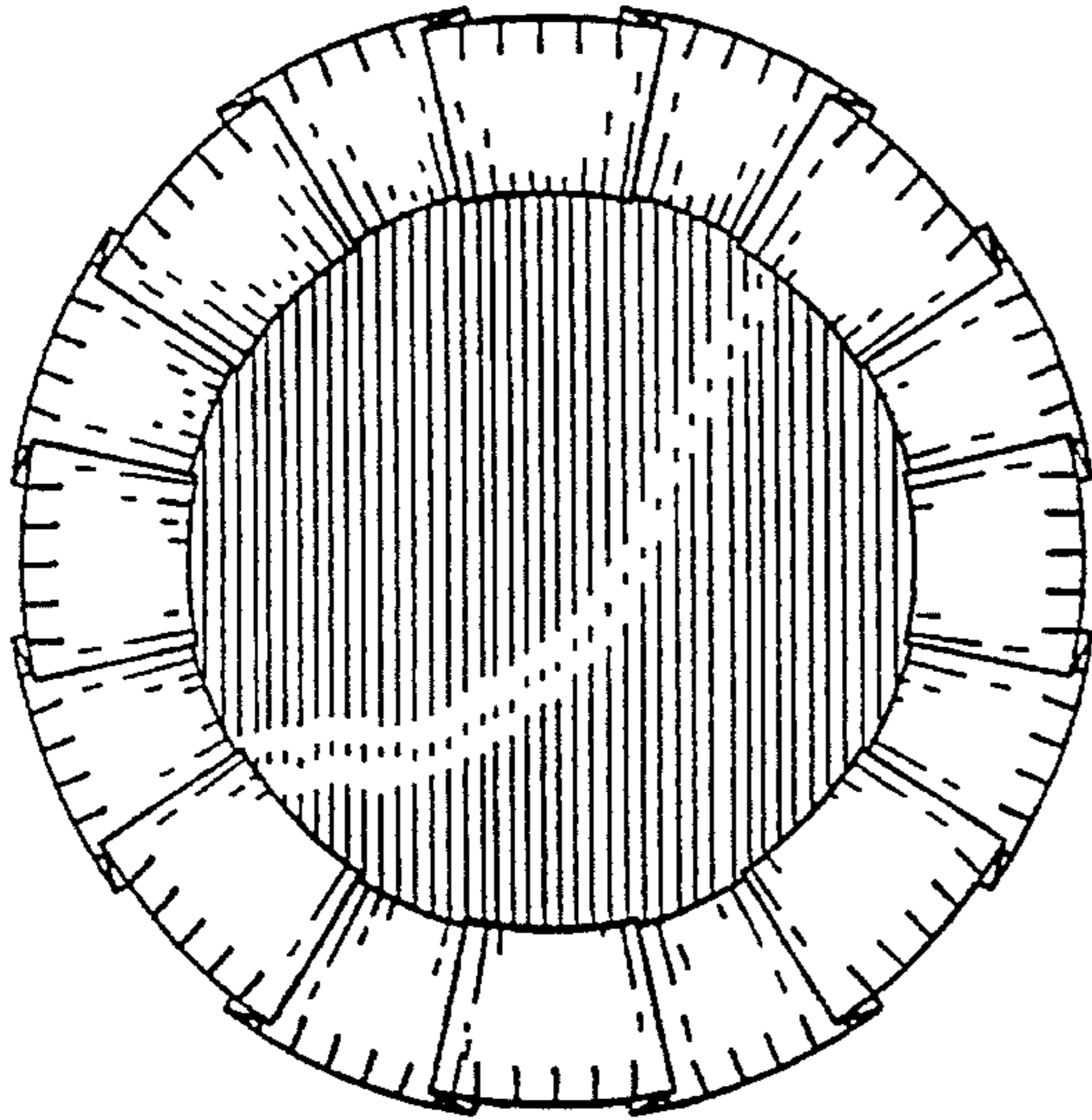

Fig. 30

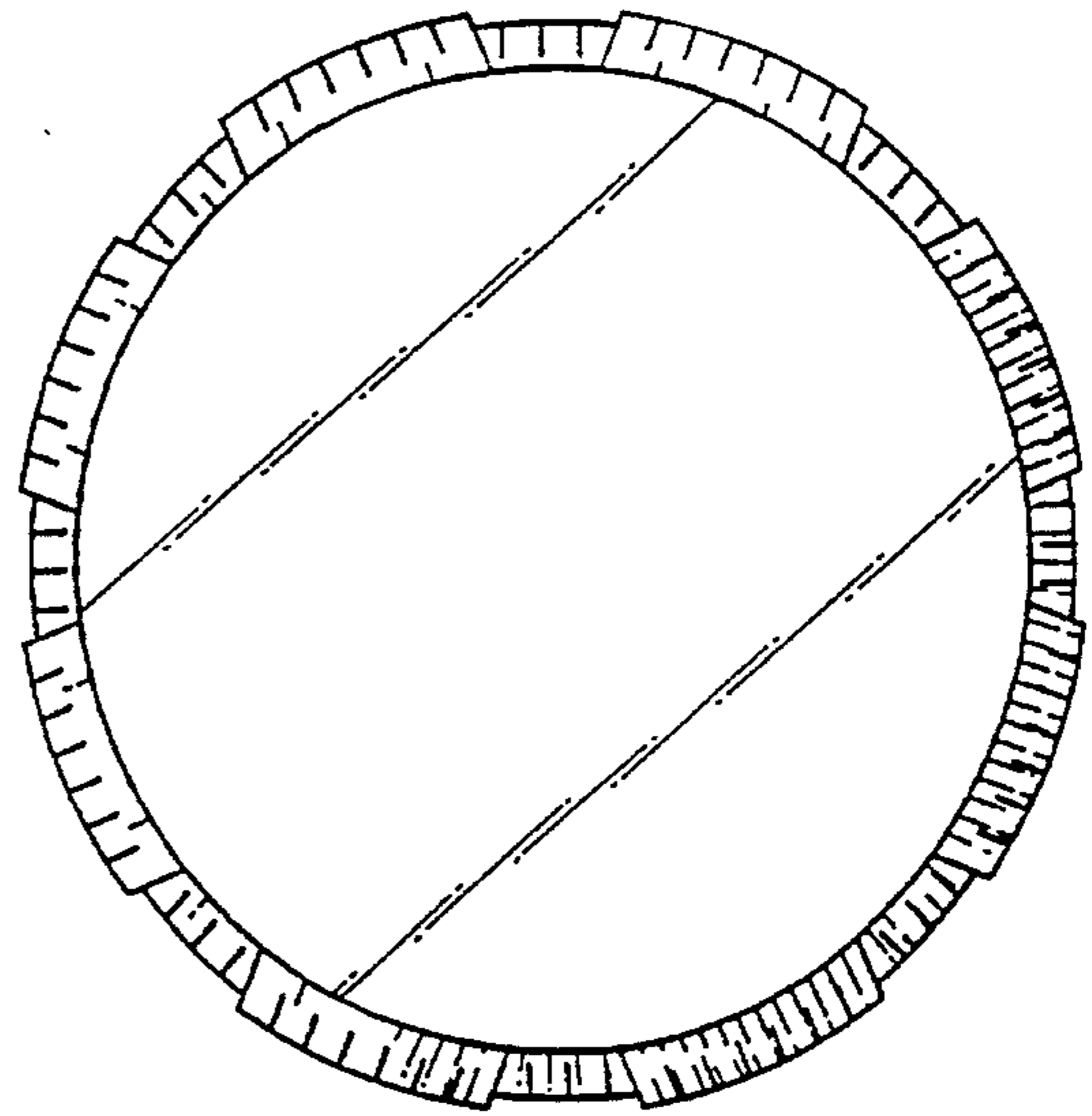

Fig. 31

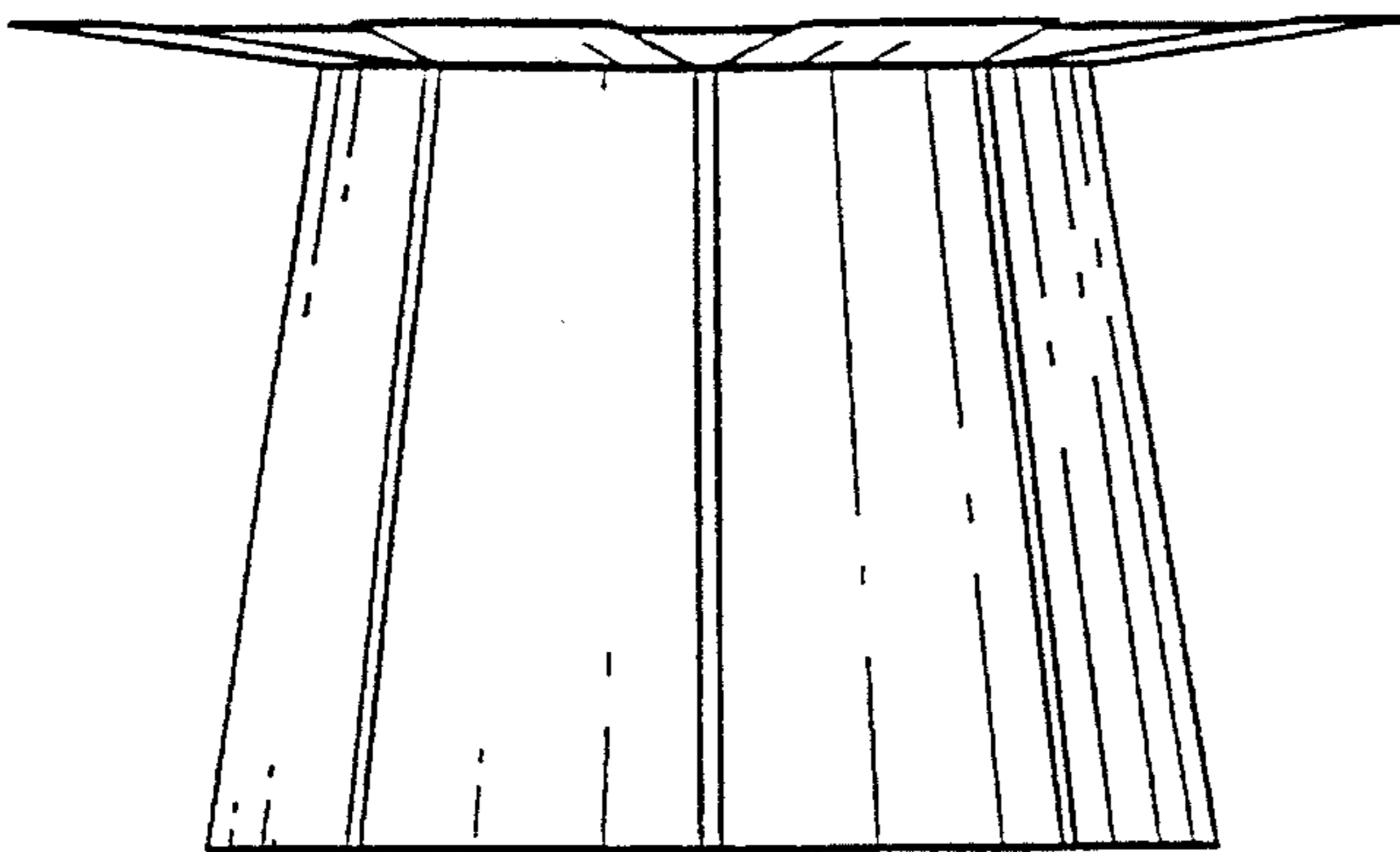

Fig. 32

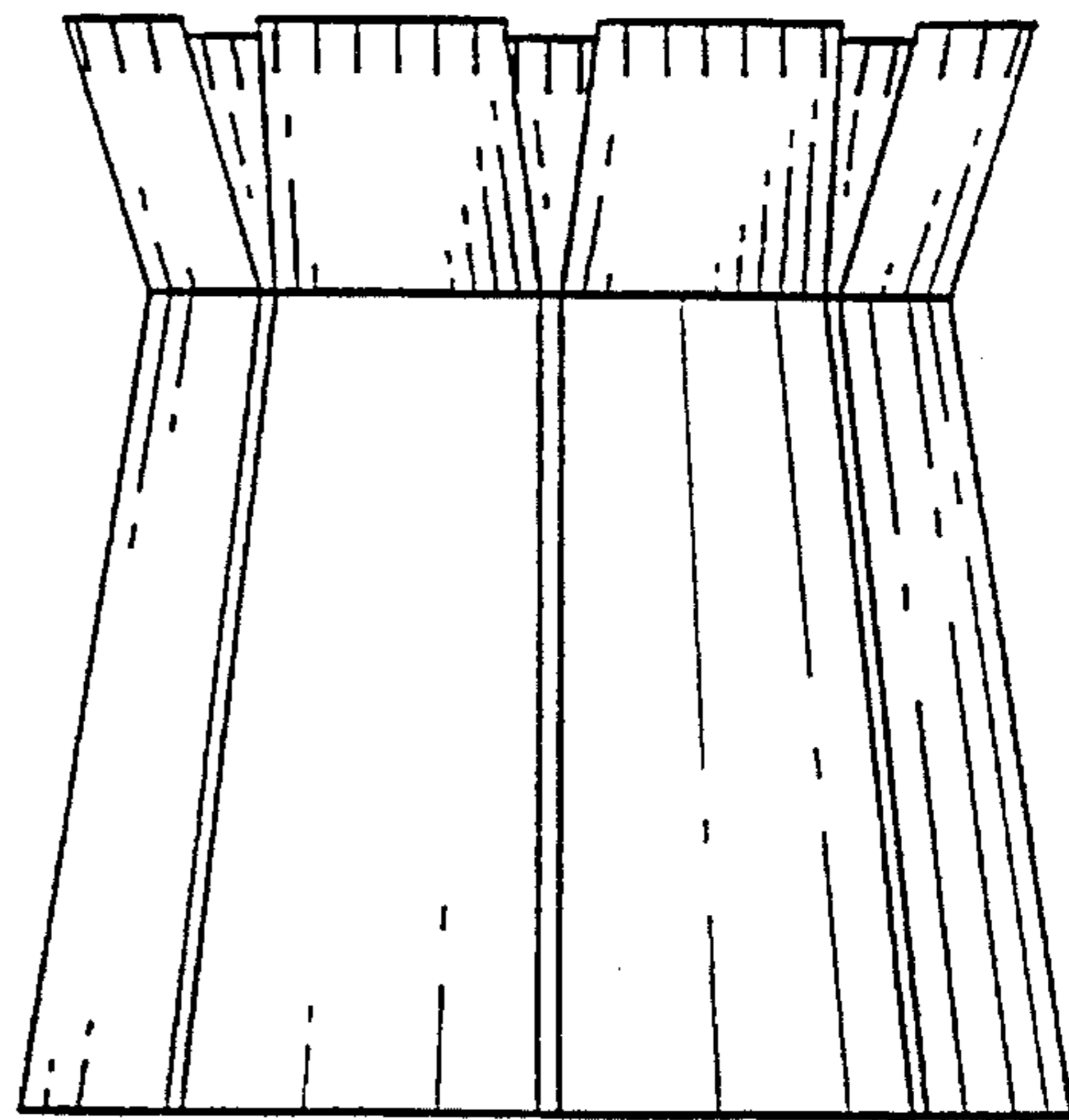

Fig. 33

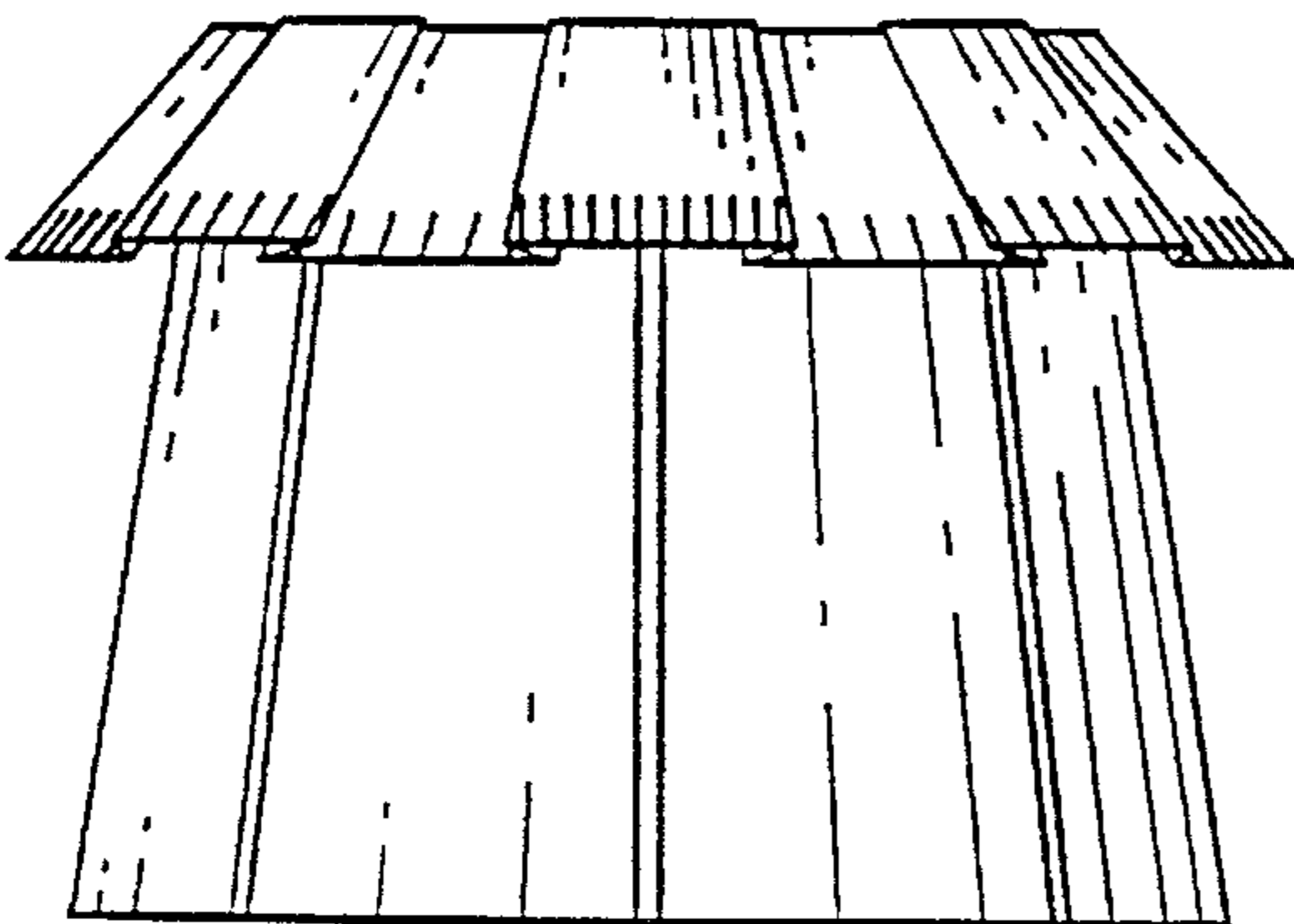

Fig. 34

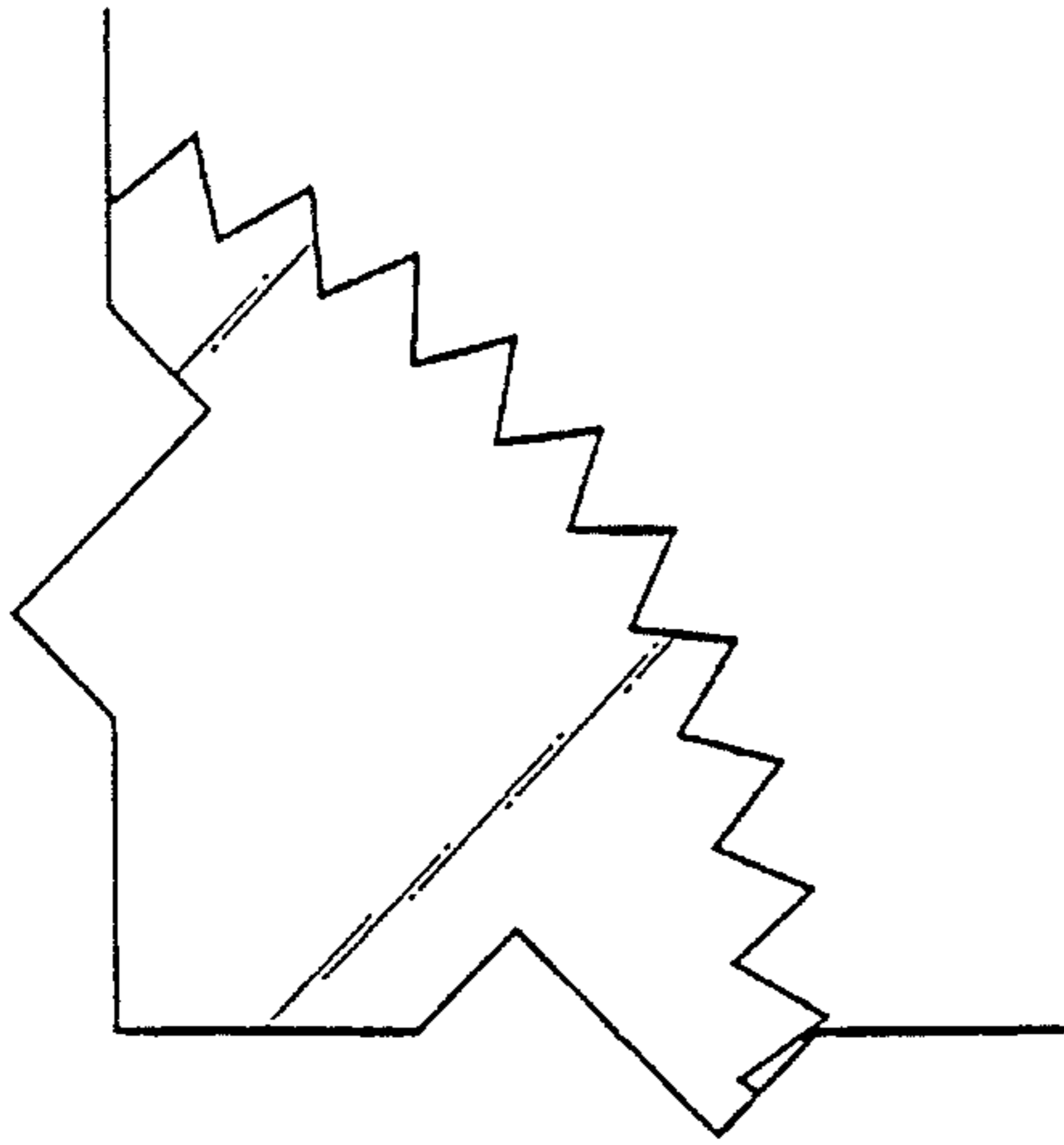

Fig. 35

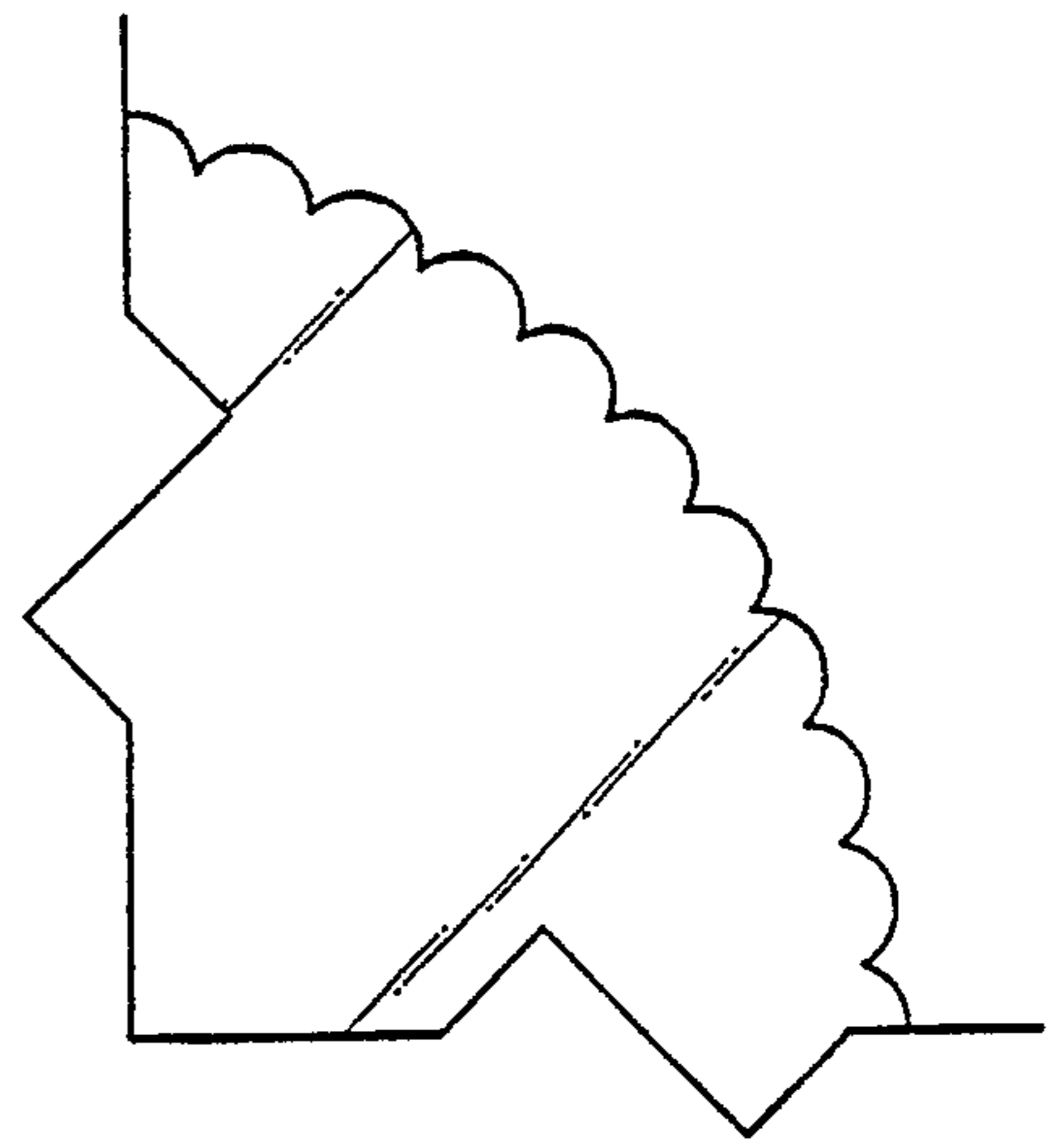

Fig. 36

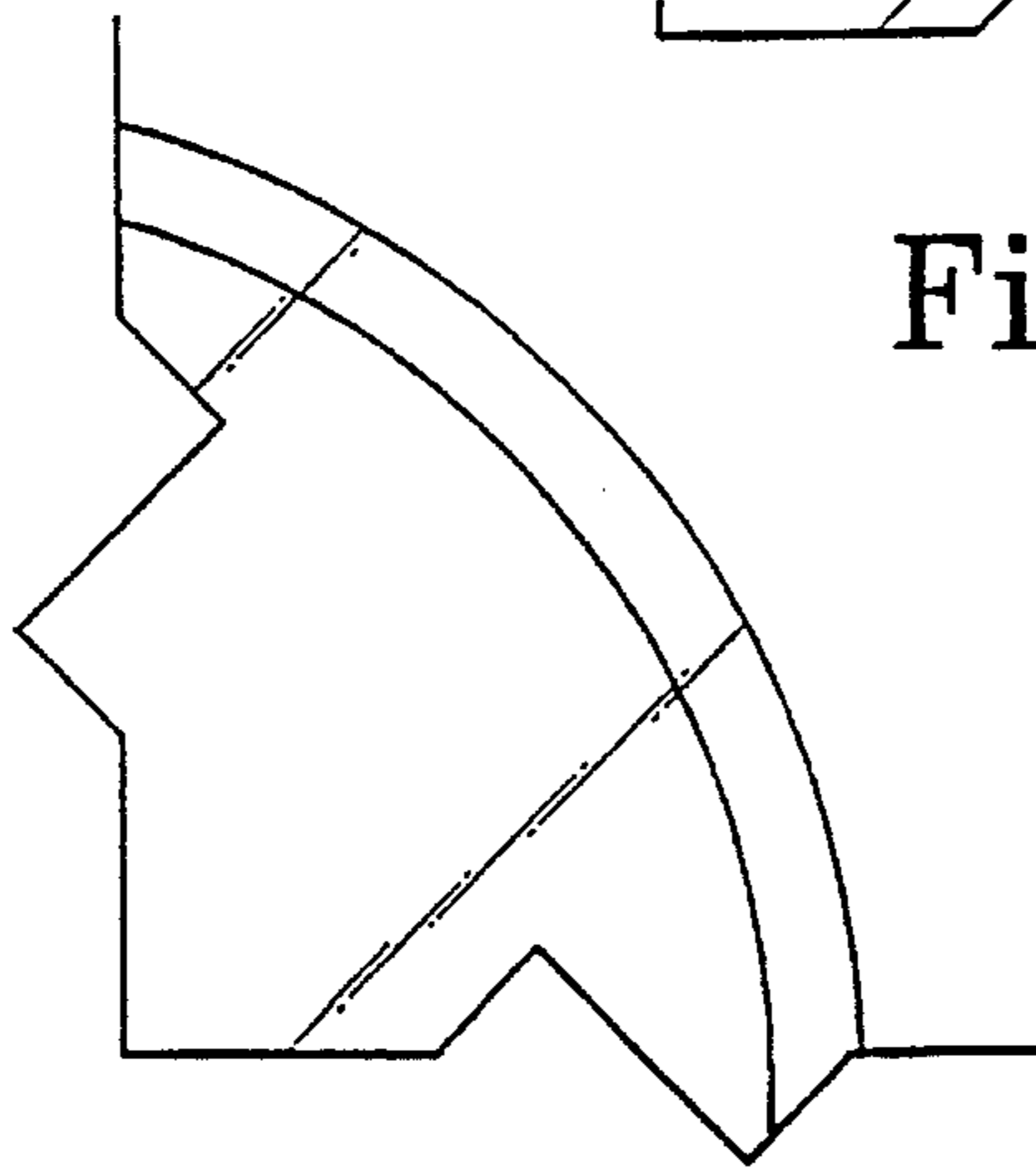

Fig. 37

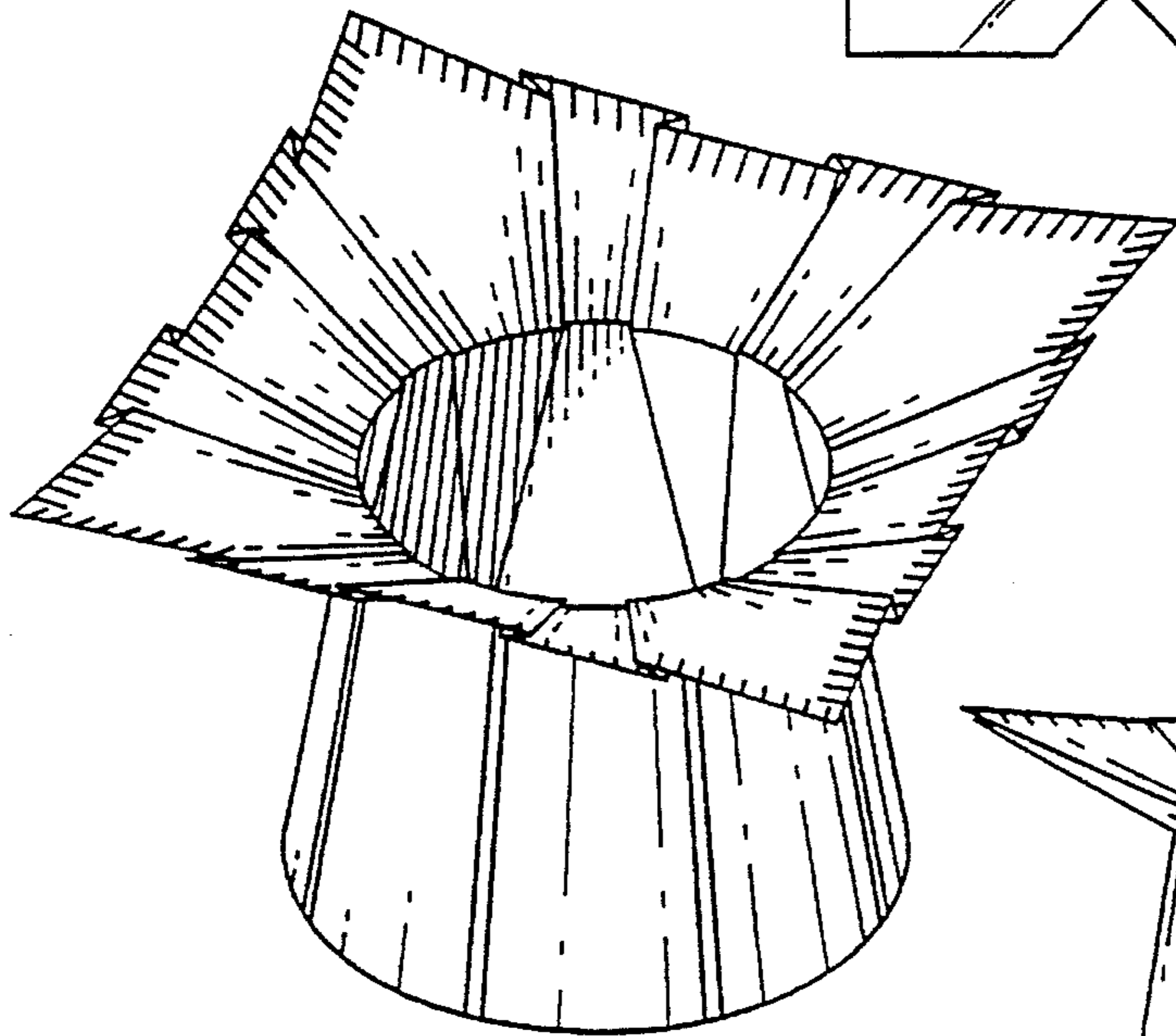

Fig. 38

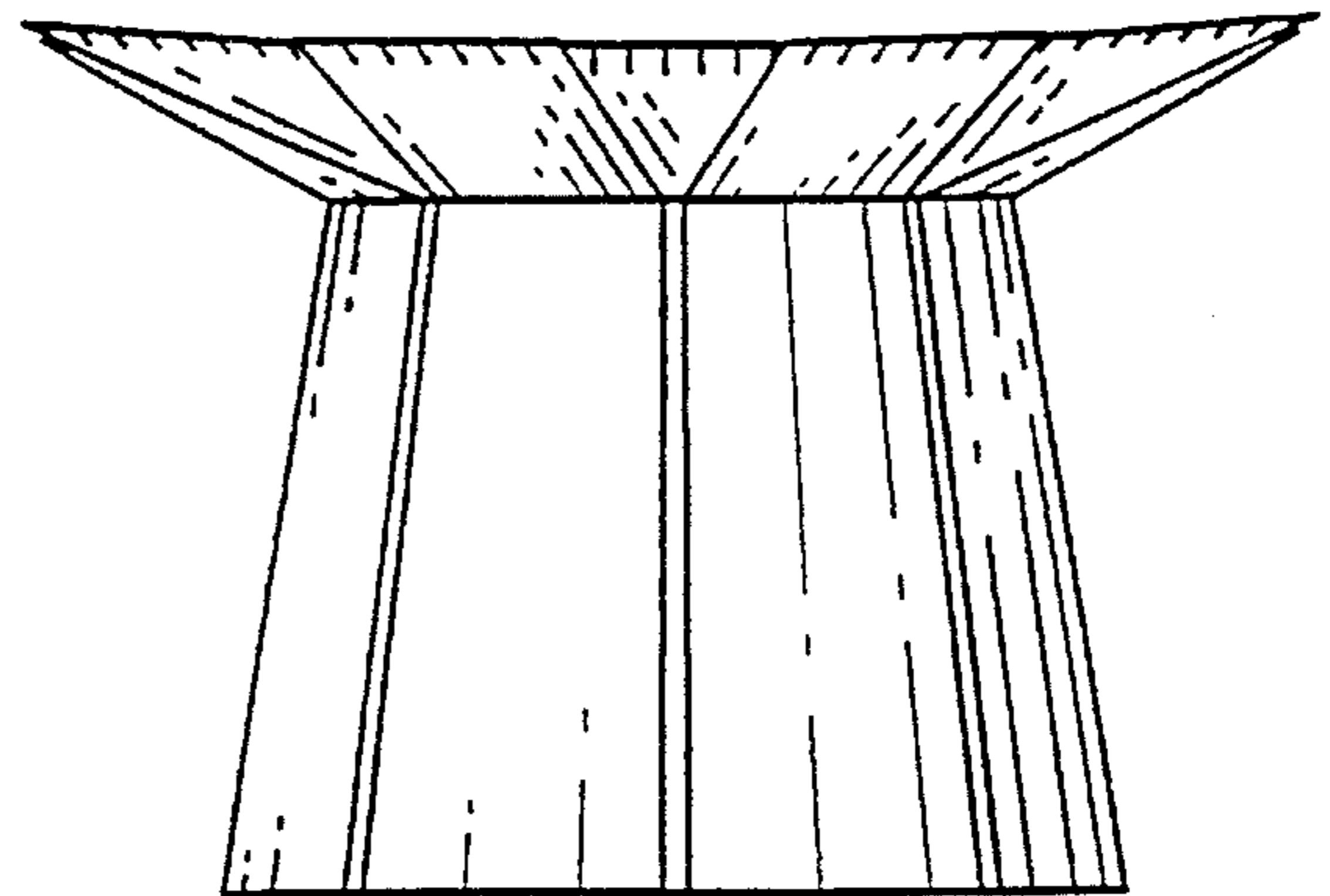

Fig. 39

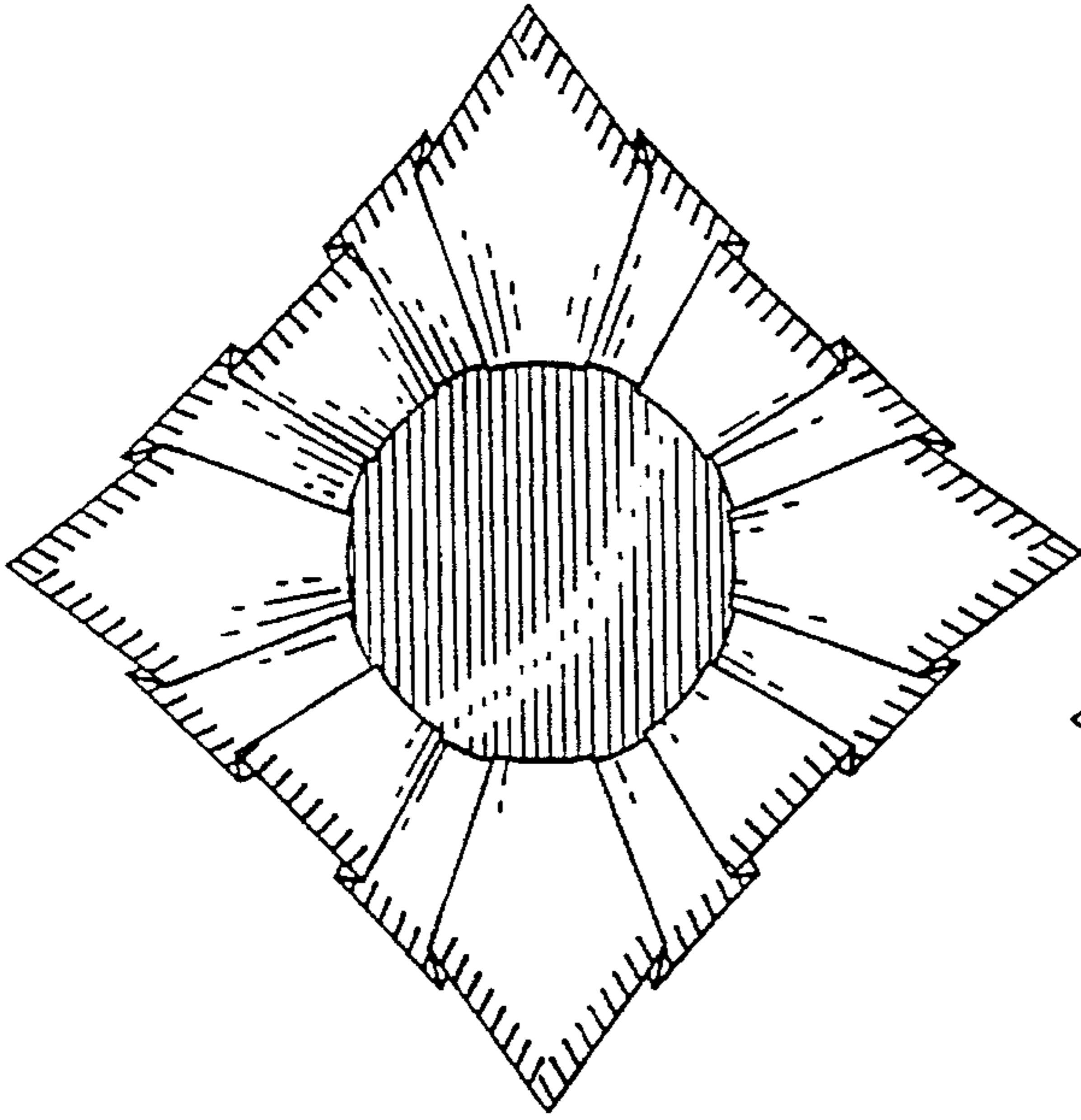

Fig. 40

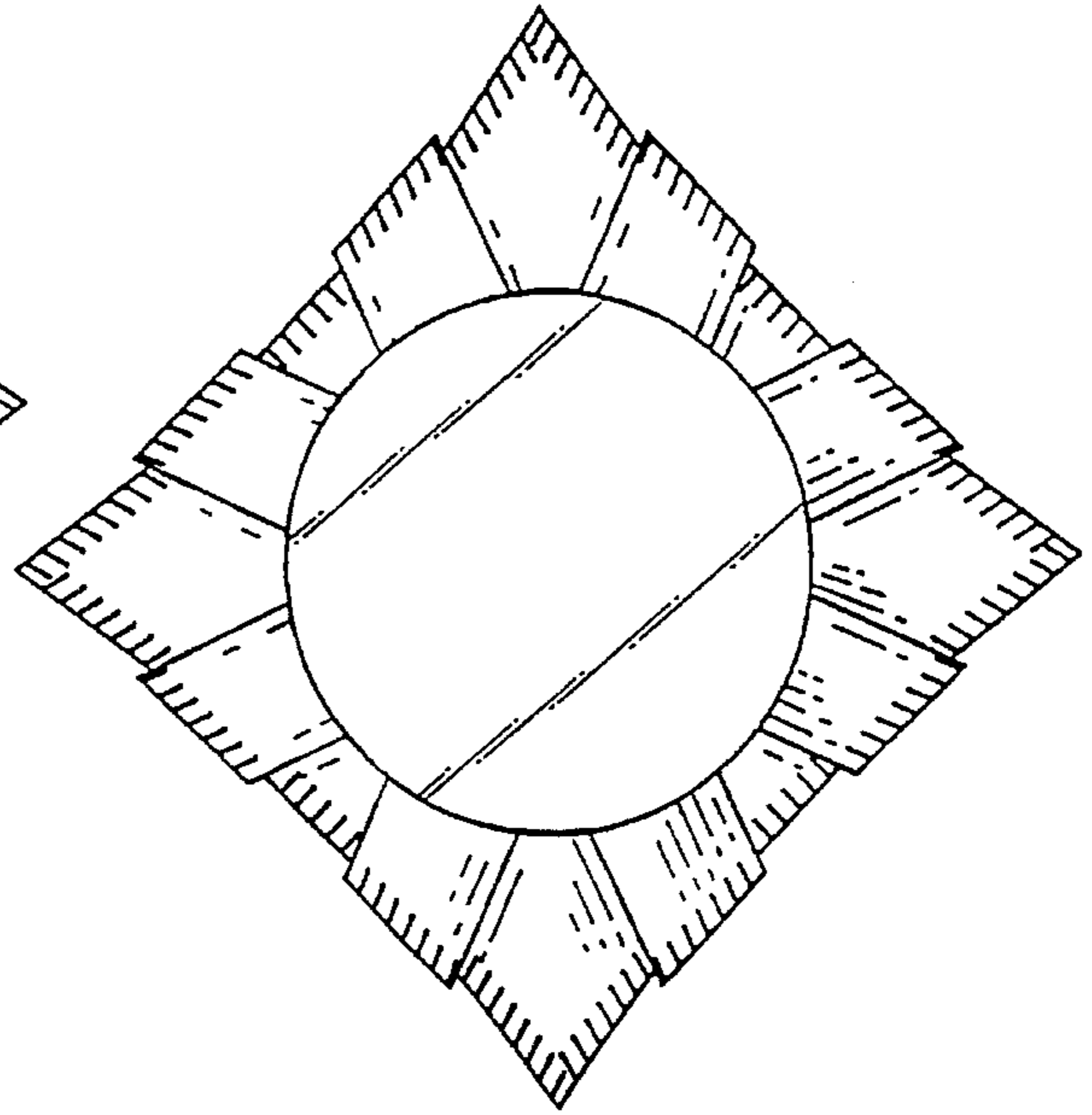

Fig. 41

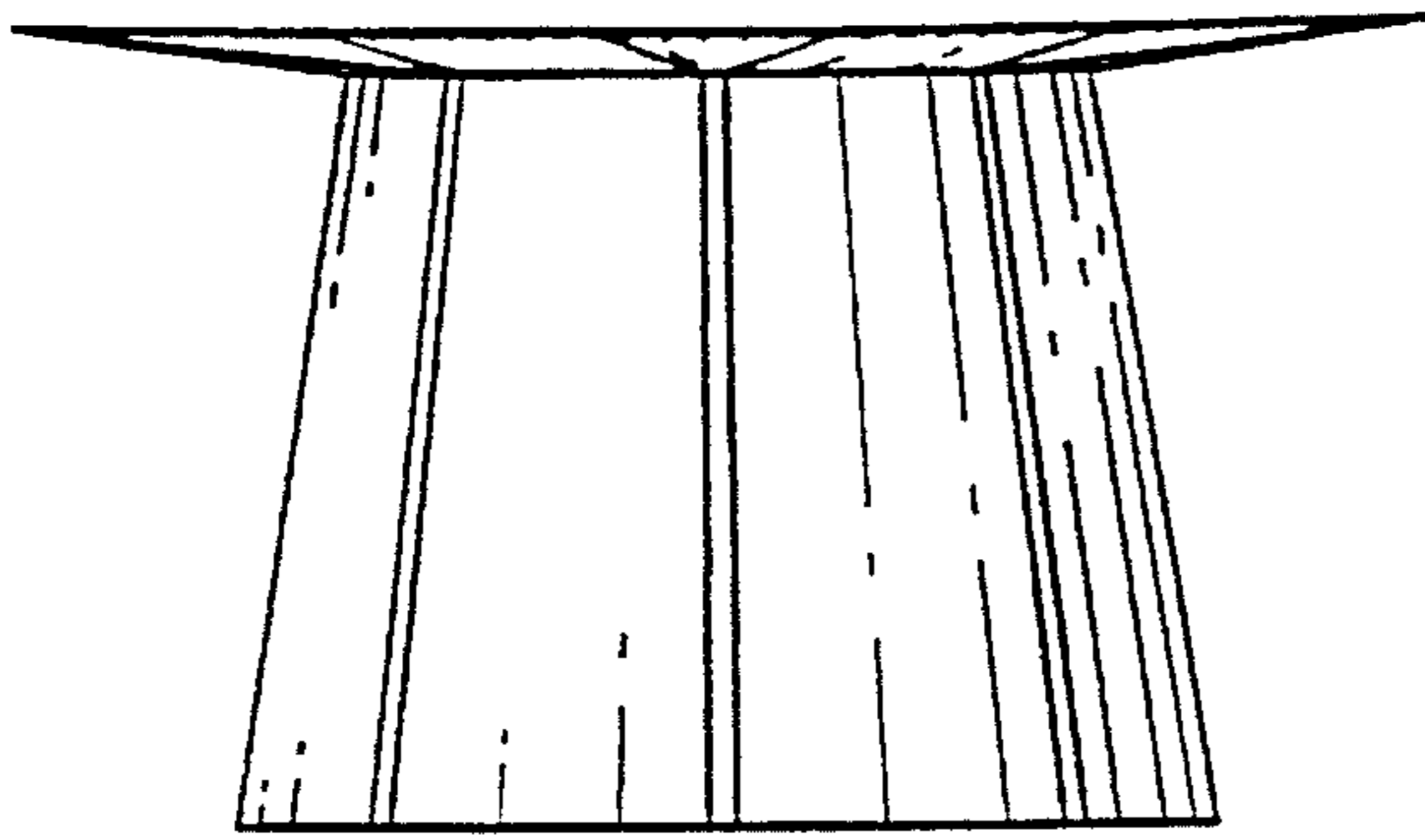

Fig. 42

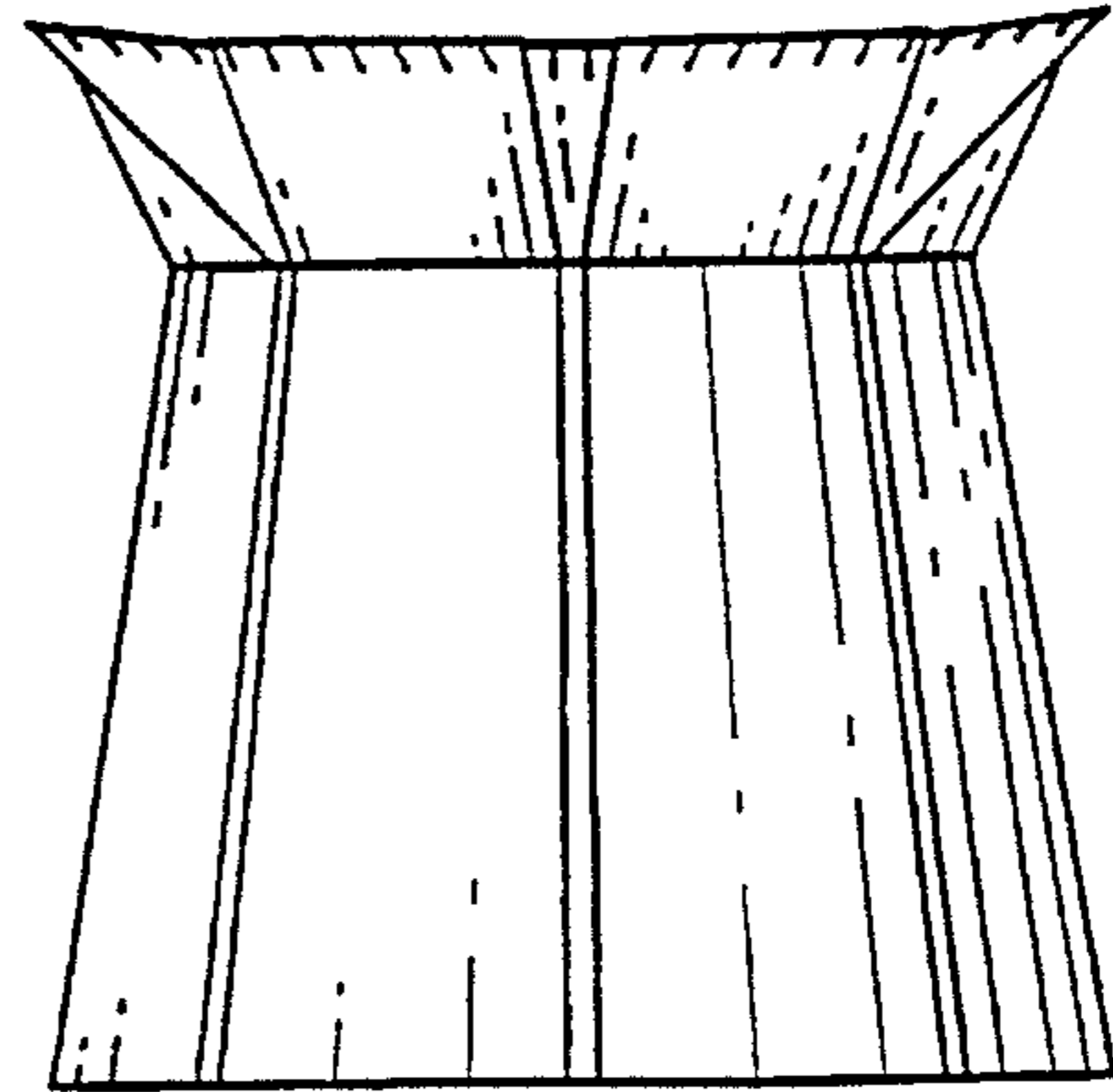

Fig. 43

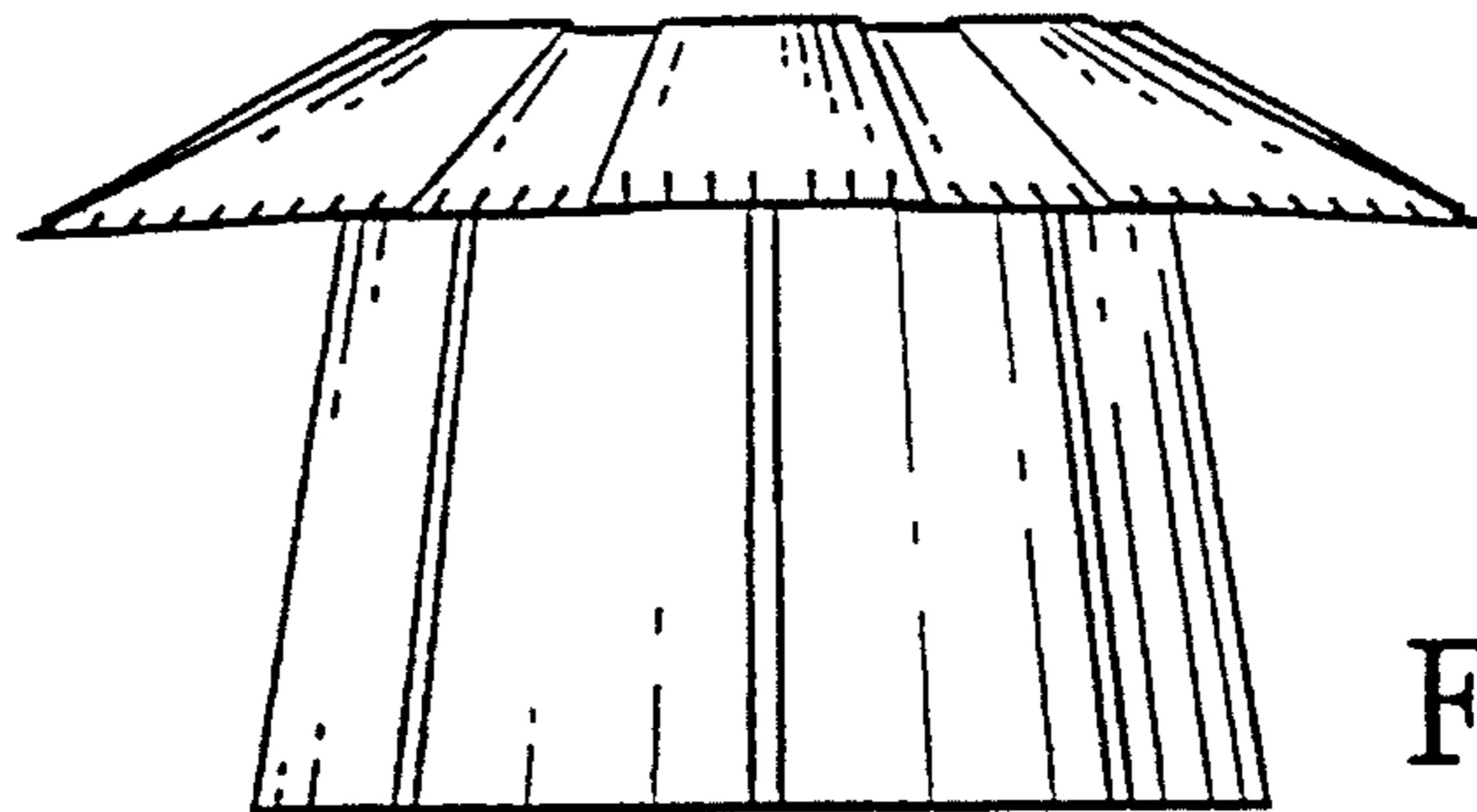

Fig. 44

UNITED STATES PATENT AND TRADEMARK OFFICE
CERTIFICATE OF CORRECTION

PATENT NO. : Des. 371,324
DATED : July 2, 1996
INVENTOR(S) : Donald e. Weder, et. al.

It is certified that error appears in the above-identified patent and that said Letters Patent is hereby corrected as shown below:

Title page, item [73] Assignee: should read--The Family Trust U/T/A;
Southpac Trust International, Inc.

Signed and Sealed this
Twenty-third Day of September, 1997

Attest:



BRUCE LEHMAN

Attesting Officer

Commissioner of Patents and Trademarks