



US00D371318S

# United States Patent [19]

Weder et al.

[11] Patent Number: **Des. 371,318**

[45] Date of Patent: **\*\*\* Jul. 2, 1996**

[54] **FLOWER POT COVER**

[75] Inventors: **Donald E. Weder; Joseph G. Straeter,**  
both of Highland, Ill.

[73] Assignees: **The Family Trust U/T/A; Southpac  
Trust International, Inc.,** both of  
Highland, Ill.

[\*] Notice: The portion of the term of this patent  
subsequent to Oct. 24, 2009, has been  
disclaimed.

[\*\*] Term: **14 Years**

[21] Appl. No.: **3,288**

[22] Filed: **Jan. 5, 1993**

### Related U.S. Application Data

[63] Continuation-in-part of Ser. No. 809,637, Dec. 16, 1991,  
Pat. No. Des. 363,451, which is a continuation-in-part of  
Ser. No. 710,272, Jun. 4, 1991, which is a continuation-in-  
part of Ser. No. 617,454, Nov. 21, 1990, abandoned, Ser. No.  
411,249, Sep. 22, 1989, Pat. No. 358,113, Ser. No. 411,247,  
Sep. 22, 1989, and Ser. No. 411,245, Sep. 22, 1989, aban-  
doned.

[52] **U.S. Cl.** ..... **D11/164**

[58] **Field of Search** ..... D11/143, 149,  
D11/152-156, 164, 89, 90; 47/66, 72; 206/423;  
215/100.5; 229/1.5 R, 1.5 B, 4.5, 87.01,  
922, 930, 108, 108.1, 109, 110; 428/27,  
35.1, 24, 542.6; D9/346, 428-431; D27/102,  
133; D26/128-136; D19/96; D7/540, 584,  
586, 587, 354

[56] **References Cited**

#### U.S. PATENT DOCUMENTS

D. 292,182	10/1987	Weder et al.	.....	D11/164
D. 292,562	11/1987	Weder et al.	.....	D11/164
D. 293,224	12/1987	Weder et al.	.....	D11/164
D. 293,775	1/1988	Weder et al.	.....	D11/164
D. 313,573	1/1991	Weder et al.	.....	D11/164
D. 317,583	6/1991	Weder et al.	.....	D11/164
D. 318,030	7/1991	Weder et al.	.....	D11/164
D. 327,234	6/1992	Vaughn	.....	D11/143
1,065,486	6/1913	Washburn	.....	229/400

1,520,647	12/1924	Hennegan	.....	47/72 X
2,054,934	9/1936	Graffenberger	.....	229/1.5 B
2,102,510	12/1937	Cecil, 2d	.....	229/1.5 B
2,355,559	8/1944	Renner	.....	229/8
2,367,749	1/1945	Barbieri	.....	229/1.5 B X
3,443,741	5/1969	Stockdale	.....	D9/431 X
5,127,817	7/1992	Weder et al.	.....	425/383
5,339,565	8/1994	Weder et al.	.....	229/1.5 B X

#### FOREIGN PATENT DOCUMENTS

103316	3/1938	Australia	.....	229/922
--------	--------	-----------	-------	---------

#### OTHER PUBLICATIONS

Exhibit A—Speed Cover® Brochure—The Simple Solution  
... , <sup>TM</sup>1989.

*Primary Examiner*—Jeffrey Asch  
*Attorney, Agent, or Firm*—Dunlap & Coddling

[57] **CLAIM**

The ornamental design for a flower pot cover, as shown and  
described.

#### DESCRIPTION

FIG. 1 is a perspective view of our new flower pot cover design;  
FIG. 2 is a side elevational view thereof;  
FIG. 3 is a top plan view thereof;  
FIG. 4 is a bottom plan view thereof;  
FIG. 5 is a side elevational view of the design of FIG. 1, the  
only difference being in the horizontal angle of the skirt;  
FIG. 6 is a side elevational view of the design of FIG. 1, the  
only difference being in the near vertical angle of the skirt;  
FIG. 7 is a side elevational view of the design of FIG. 1, the  
only difference being in the downward angle of the skirt;  
FIG. 8 is a perspective view of a second embodiment of our  
new flower pot cover design;  
FIG. 9 is a side elevational view thereof;  
FIG. 10 is a top plan view thereof;  
FIG. 11 is bottom plan view thereof;  
FIG. 12 is a side elevational view of the design of FIG. 8,  
the only difference being in the horizontal angle of the skirt;  
FIG. 13 is a side elevational view of the design of FIG. 8,  
the only difference being in the near vertical angle of the  
skirt;

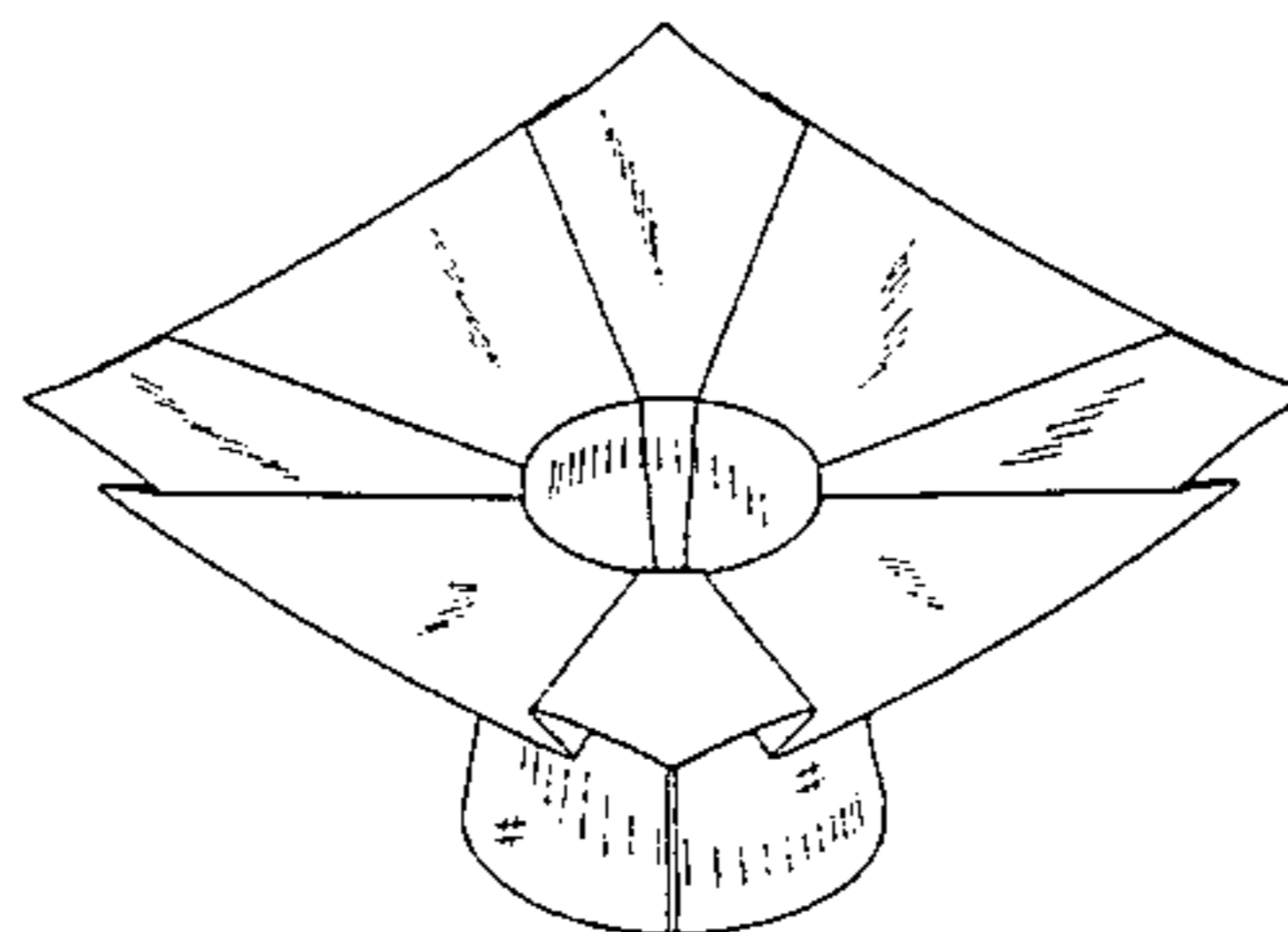
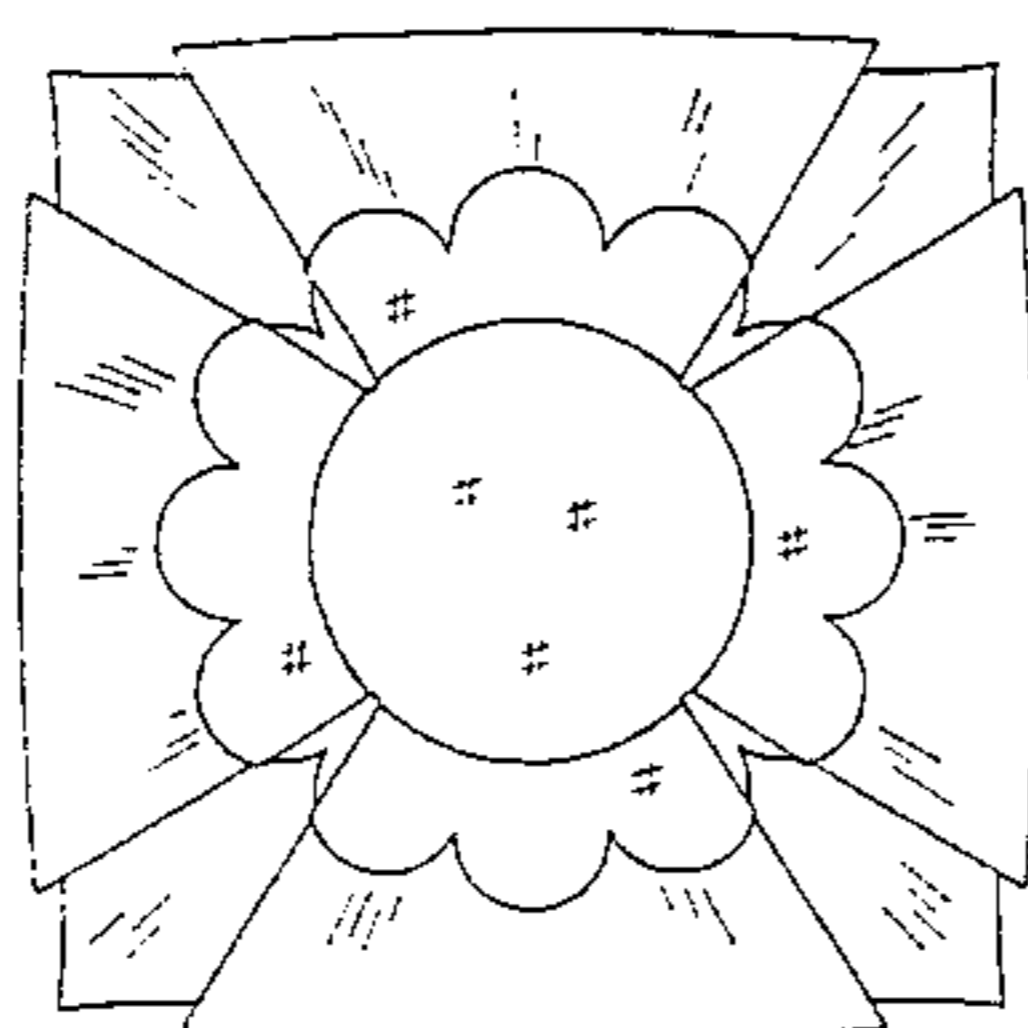
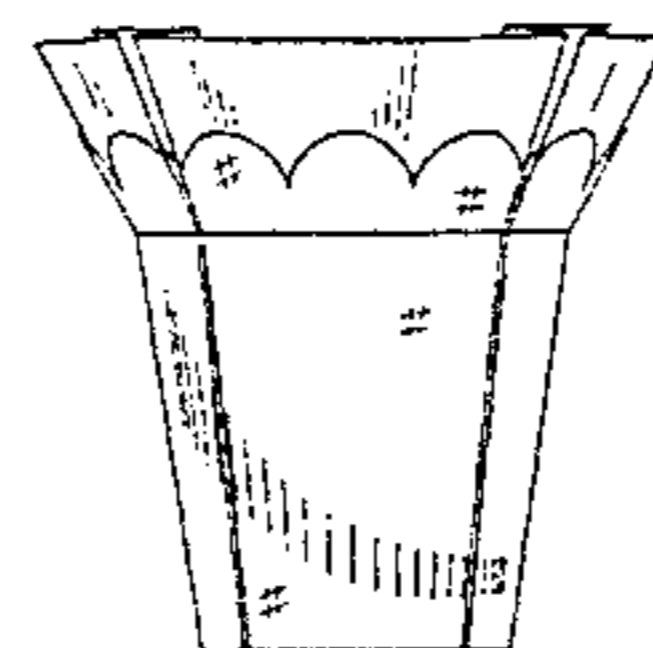
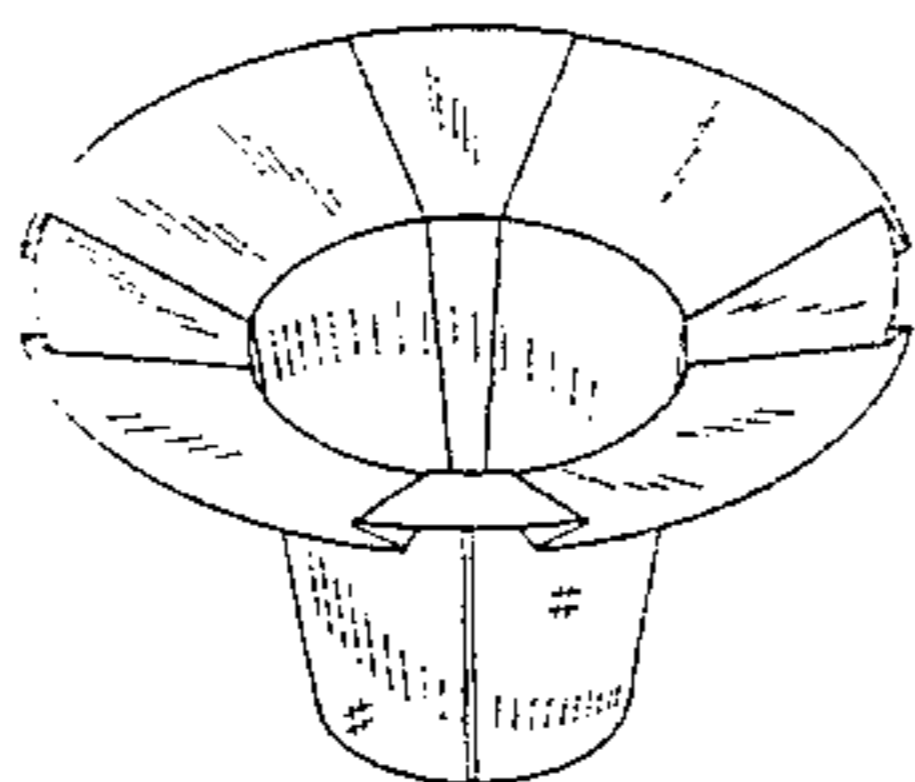

FIG. 14 is a side elevational view of the design of FIG. 8, the only difference being in the downward angle of the skirt;  
FIG. 15 is a perspective view of a third embodiment of our new flower pot cover design;  
FIG. 16 is a side elevational view thereof;  
FIG. 17 is a top plan view thereof;  
FIG. 18 is a bottom plan view thereof;  
FIG. 19 is a side elevational view of the design of FIG. 15, the only difference being in the horizontal angle of the skirt;  
FIG. 20 is a side elevational view of the design of FIG. 15, the only difference being in the near vertical angle of the skirt;  
FIG. 21 is a side elevational view of the design of FIG. 15, the only difference being in the downward angle of the skirt;  
FIG. 22 is a perspective view of a fourth embodiment of our new flower pot cover design;  
FIG. 23 is a side elevational view thereof;  
FIG. 24 is a top plan view thereof;  
FIG. 25 is bottom plan view thereof;  
FIG. 26 is a side elevational view of the design of FIG. 22, the only difference being in the horizontal angle of the skirt;  
FIG. 27 is a side elevational view of the design of FIG. 22, the only difference being in the near vertical angle of the skirt;

FIG. 28 is a side elevational view of the design of FIG. 22, the only difference being in the downward angle of the skirt;  
FIG. 29 is a perspective view of a fifth embodiment of our new flower pot cover design;  
FIG. 30 is a side elevational view thereof;  
FIG. 31 is a top plan view thereof;  
FIG. 32 is bottom plan view thereof;  
FIG. 33 is a side elevational view of the design of FIG. 29, the only difference being in the horizontal angle of the skirt;  
FIG. 34 is a side elevational view of the design of FIG. 29, the only difference being in the near vertical angle of the skirt; and,  
FIG. 35 is a side elevational view of the design of FIG. 29, the only difference being in the downward angle of the skirt.  
The characteristic feature of the design resides in the specific pleating arrangement, comprised of the parrallel disposition of the exterior folds, in combination with the interior V-shaped folds, all as best seen in FIGS. 1, 8, 15, 22 and 29.

**1 Claim, 6 Drawing Sheets**



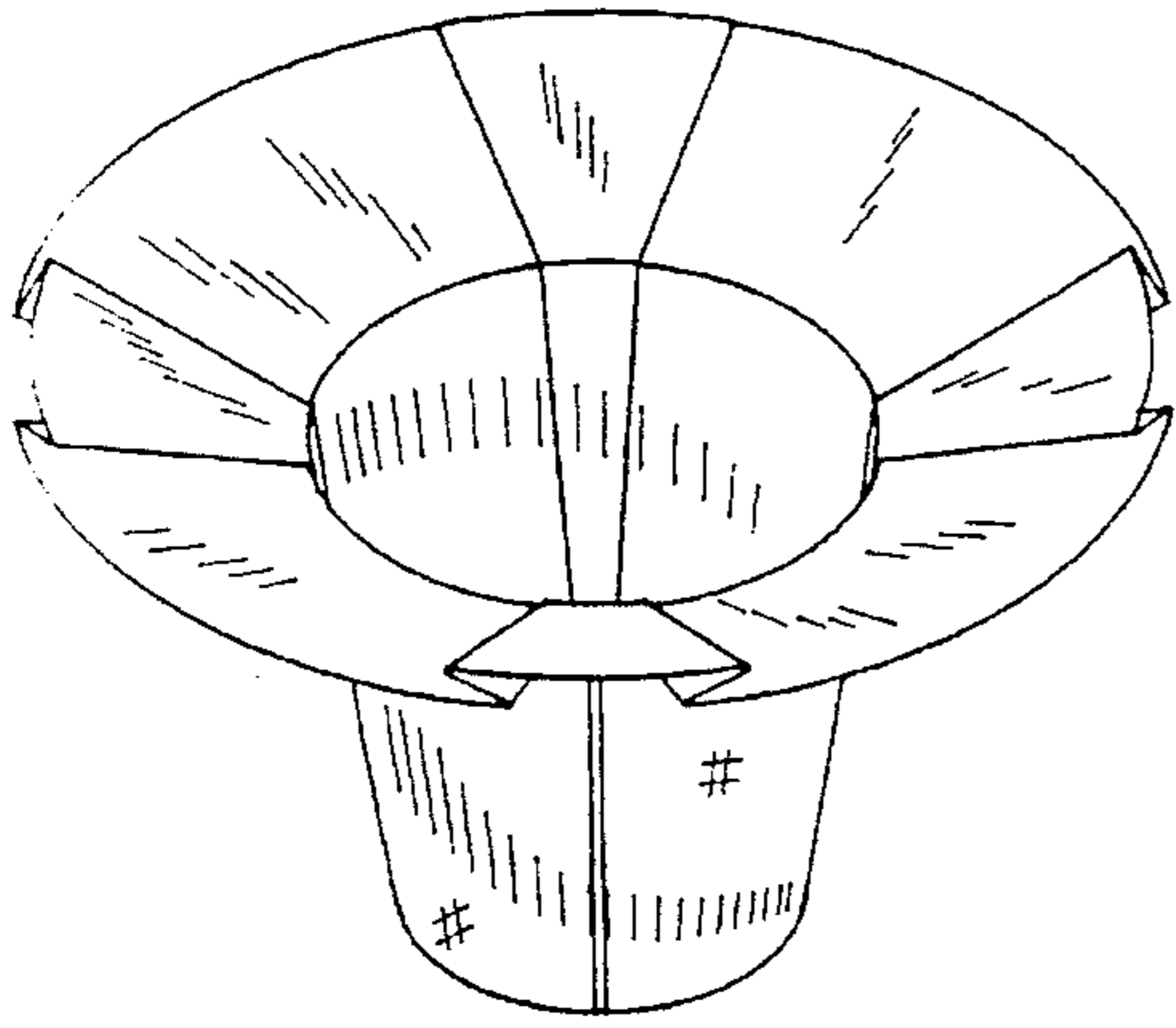

FIG. 1

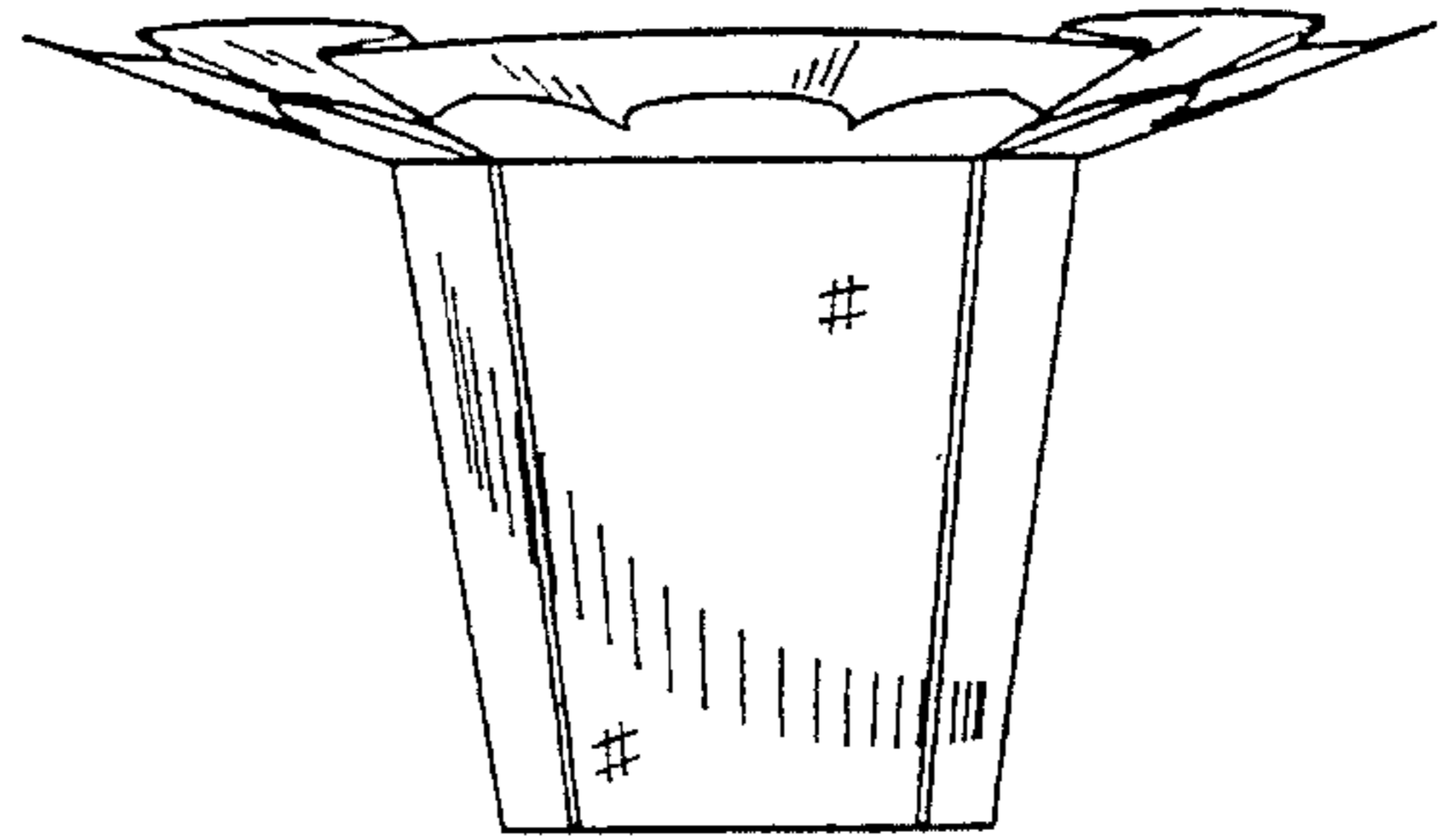

FIG. 2

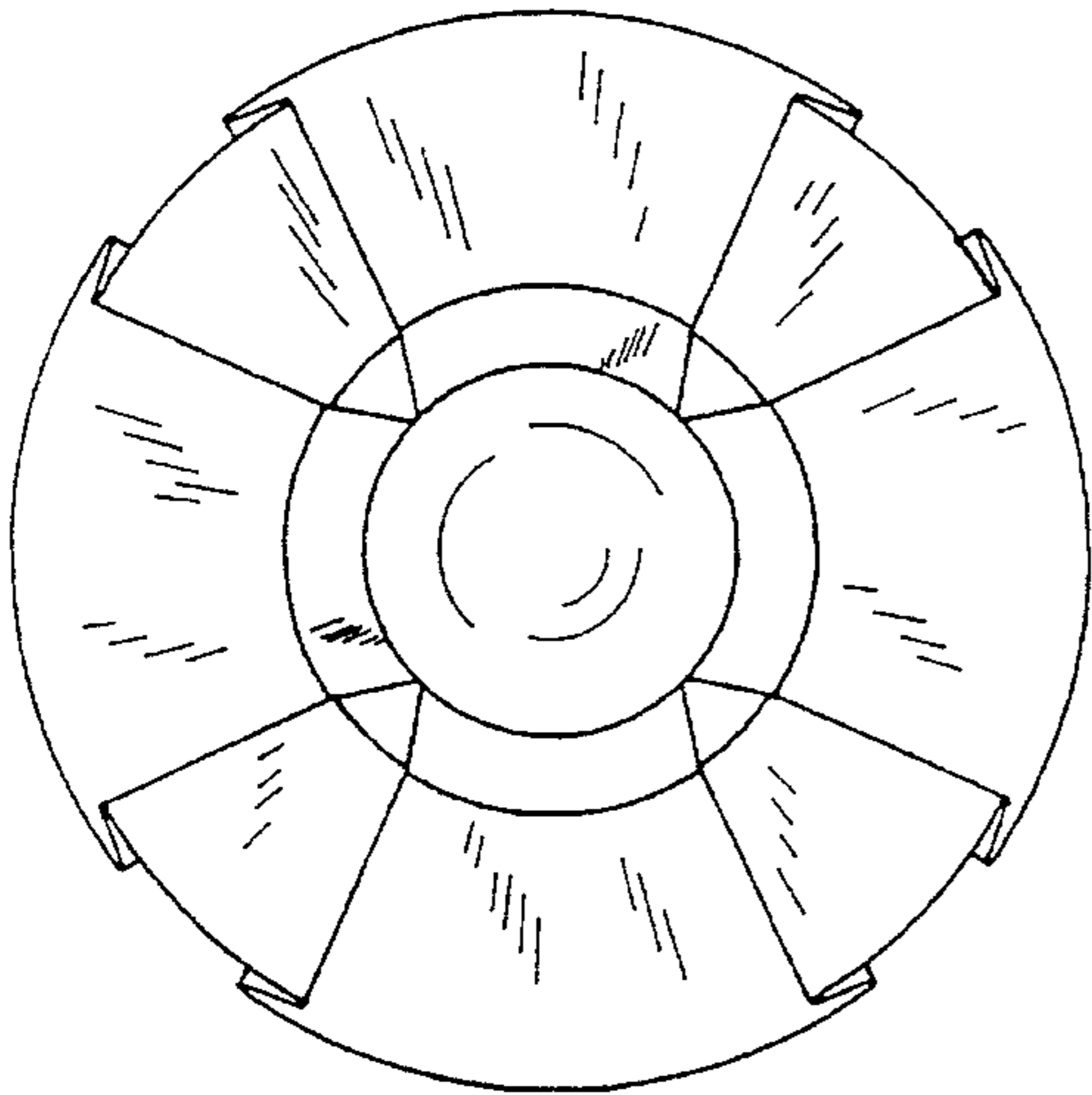

FIG. 3

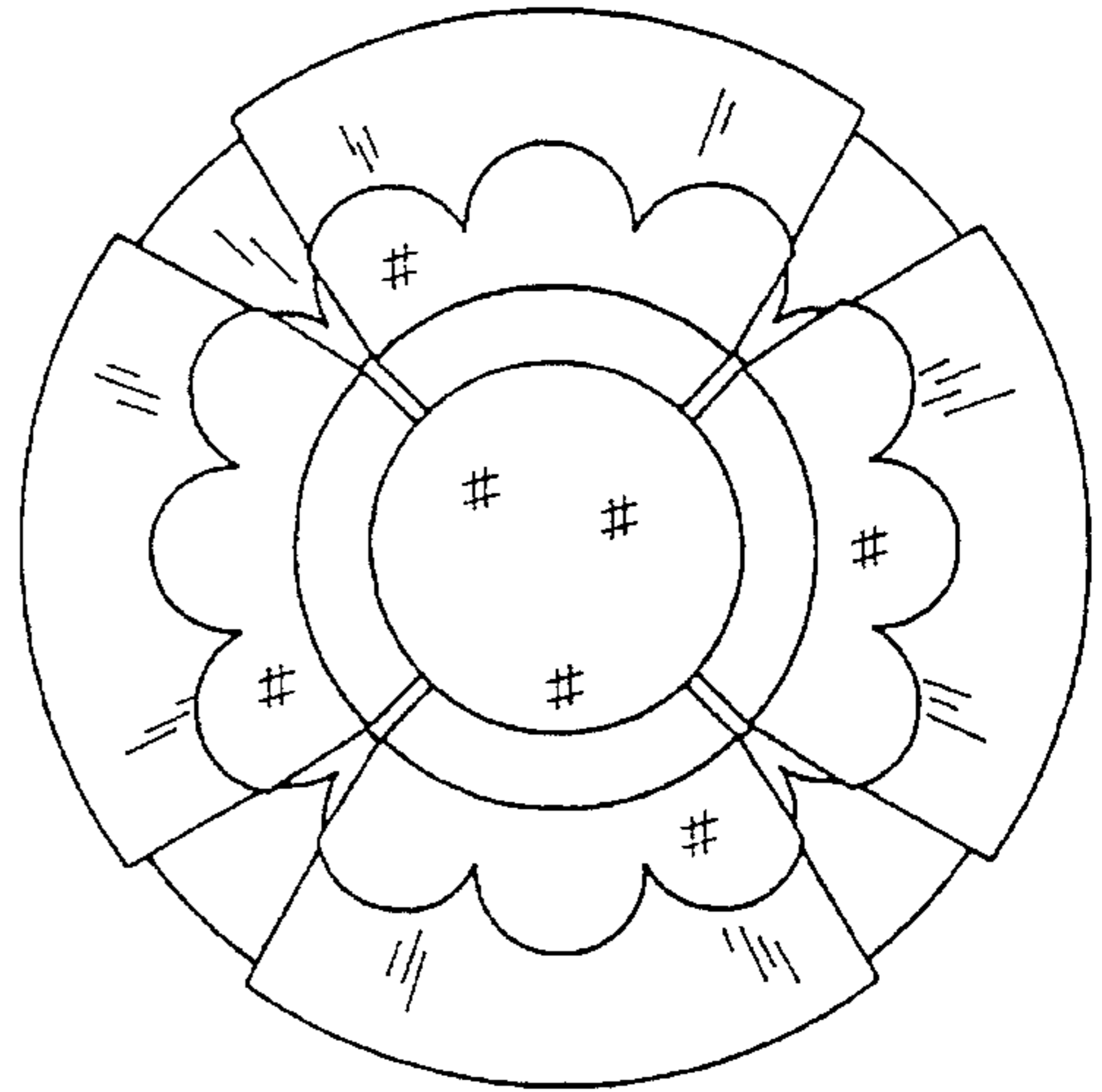

FIG. 4

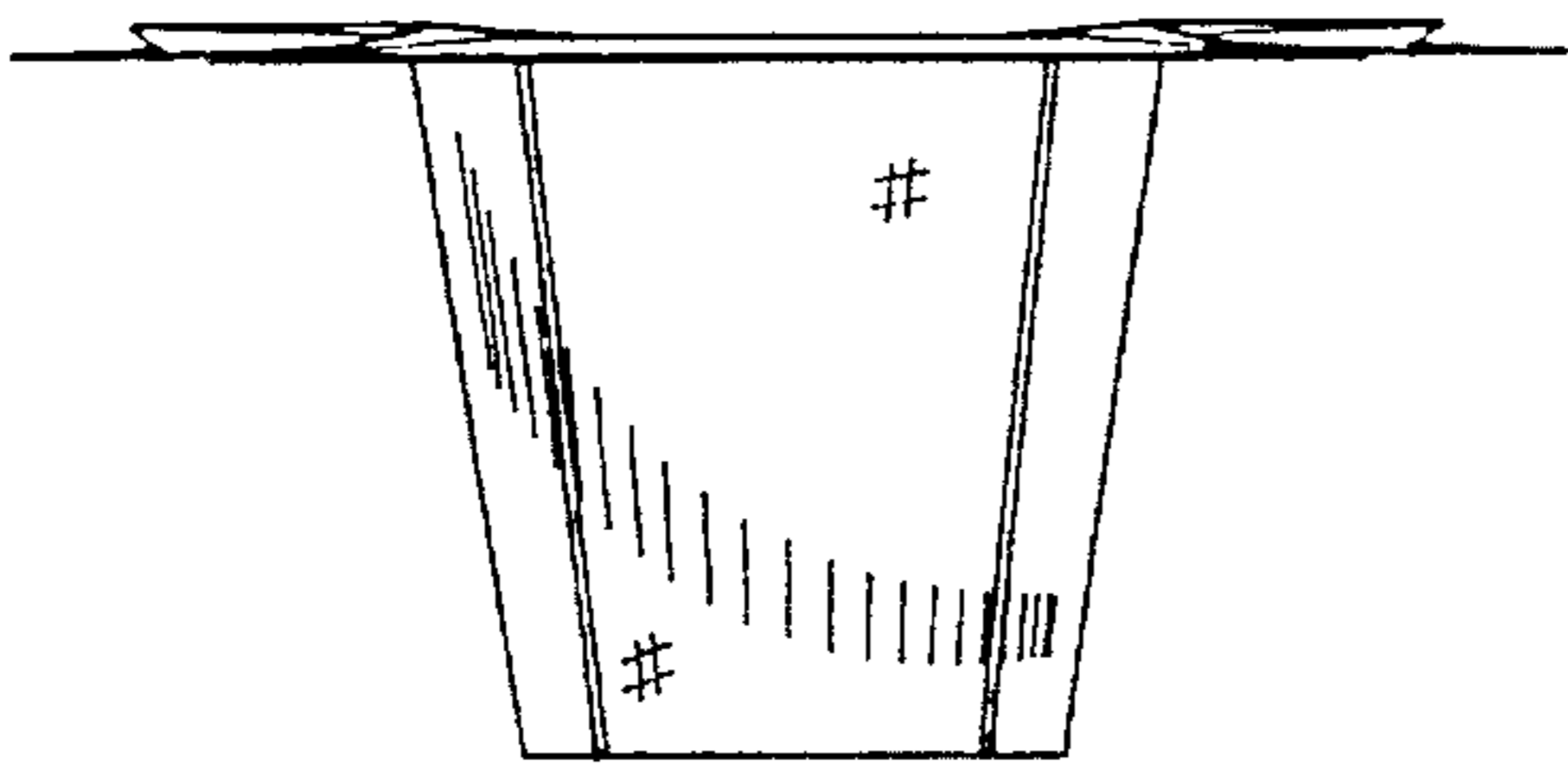

FIG. 5

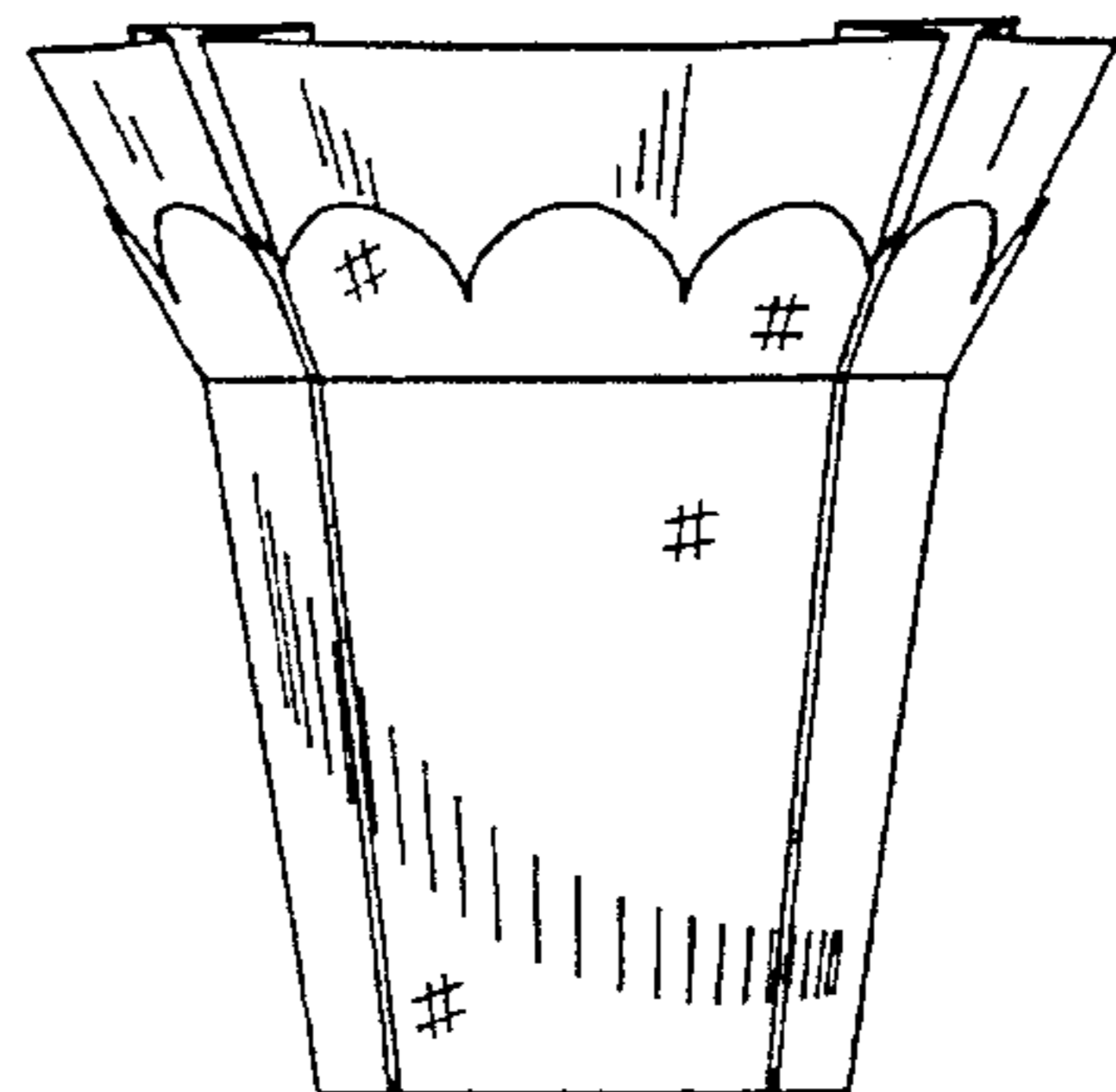

FIG. 6

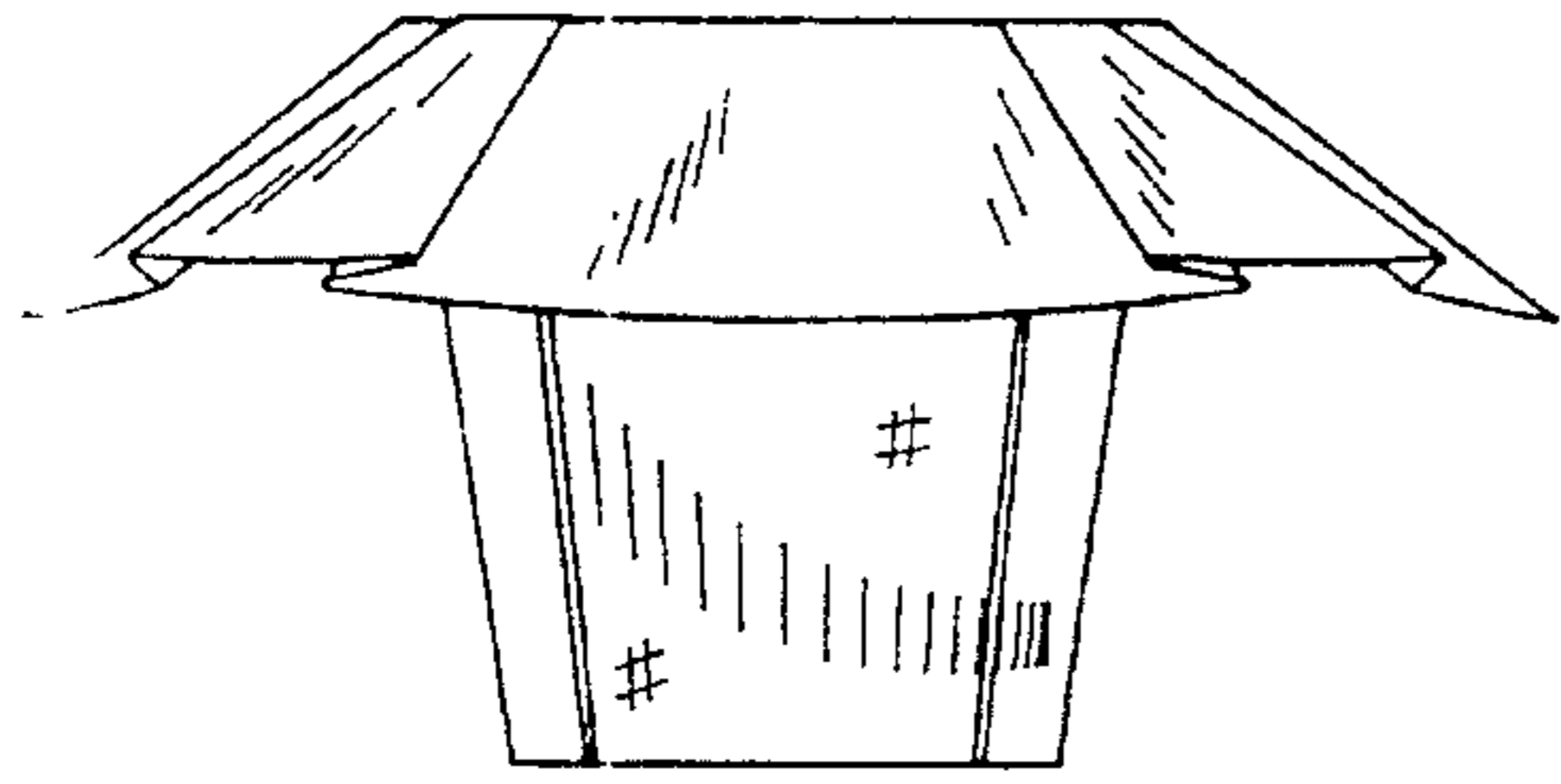

FIG. 7

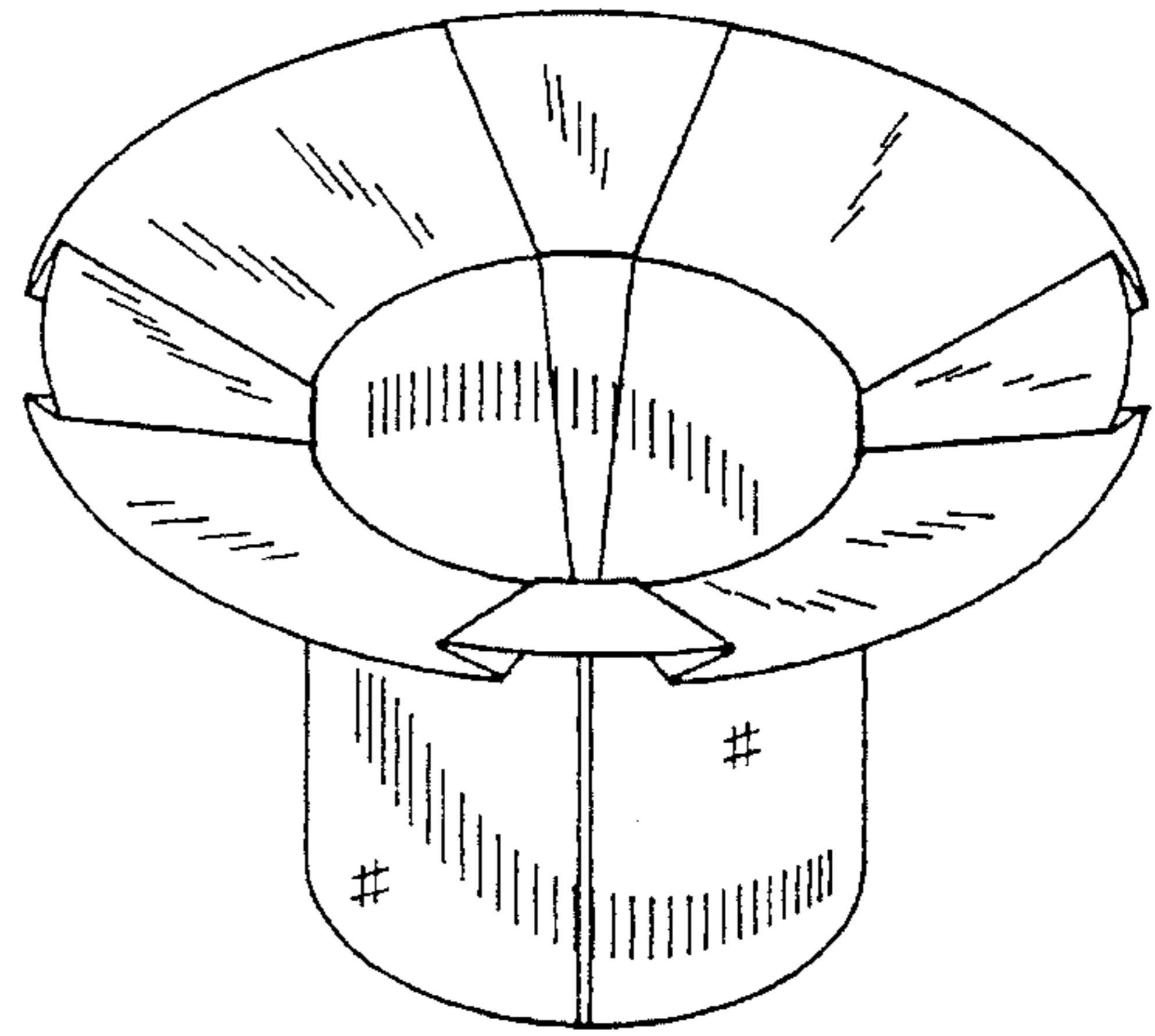

FIG. 8

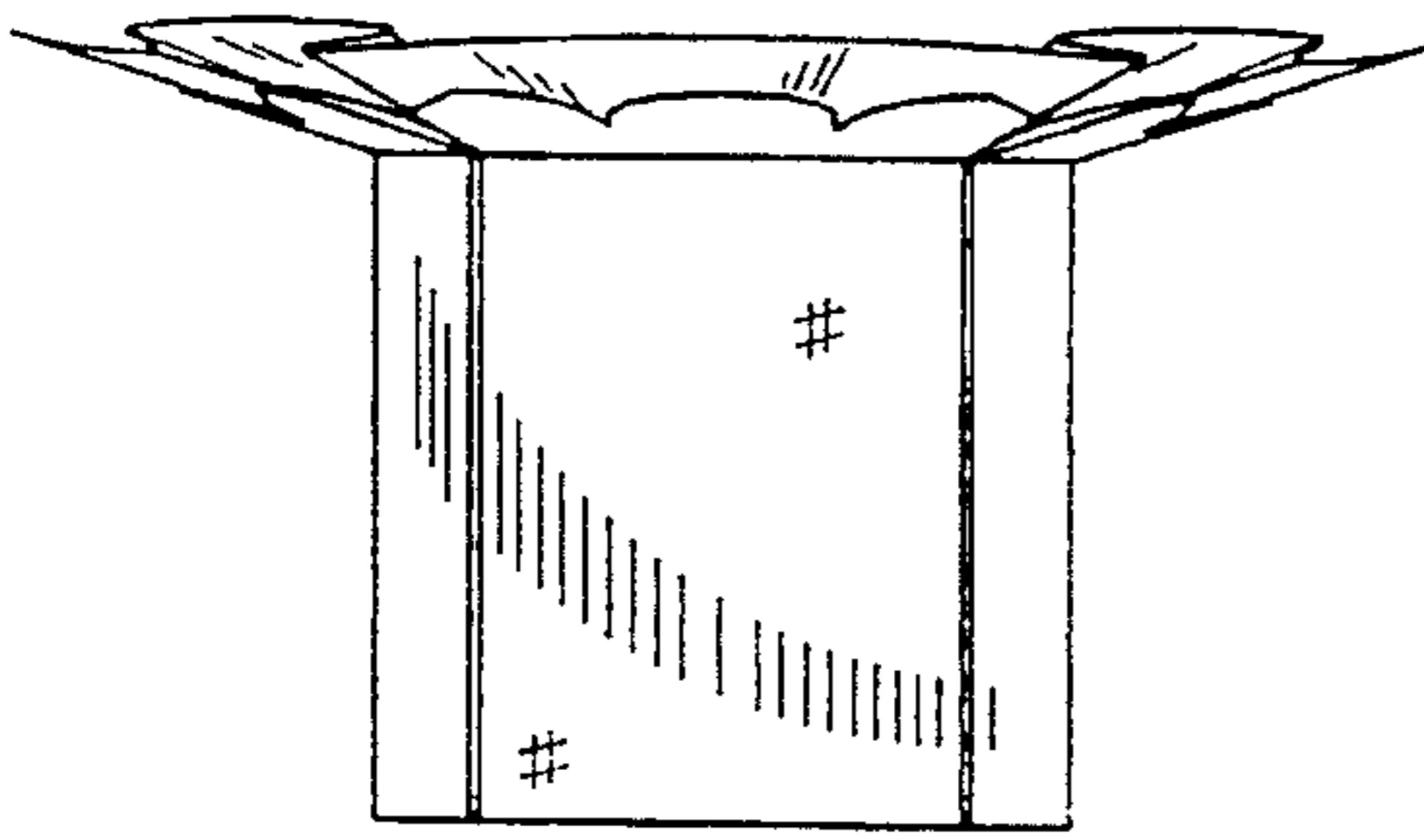

FIG. 9

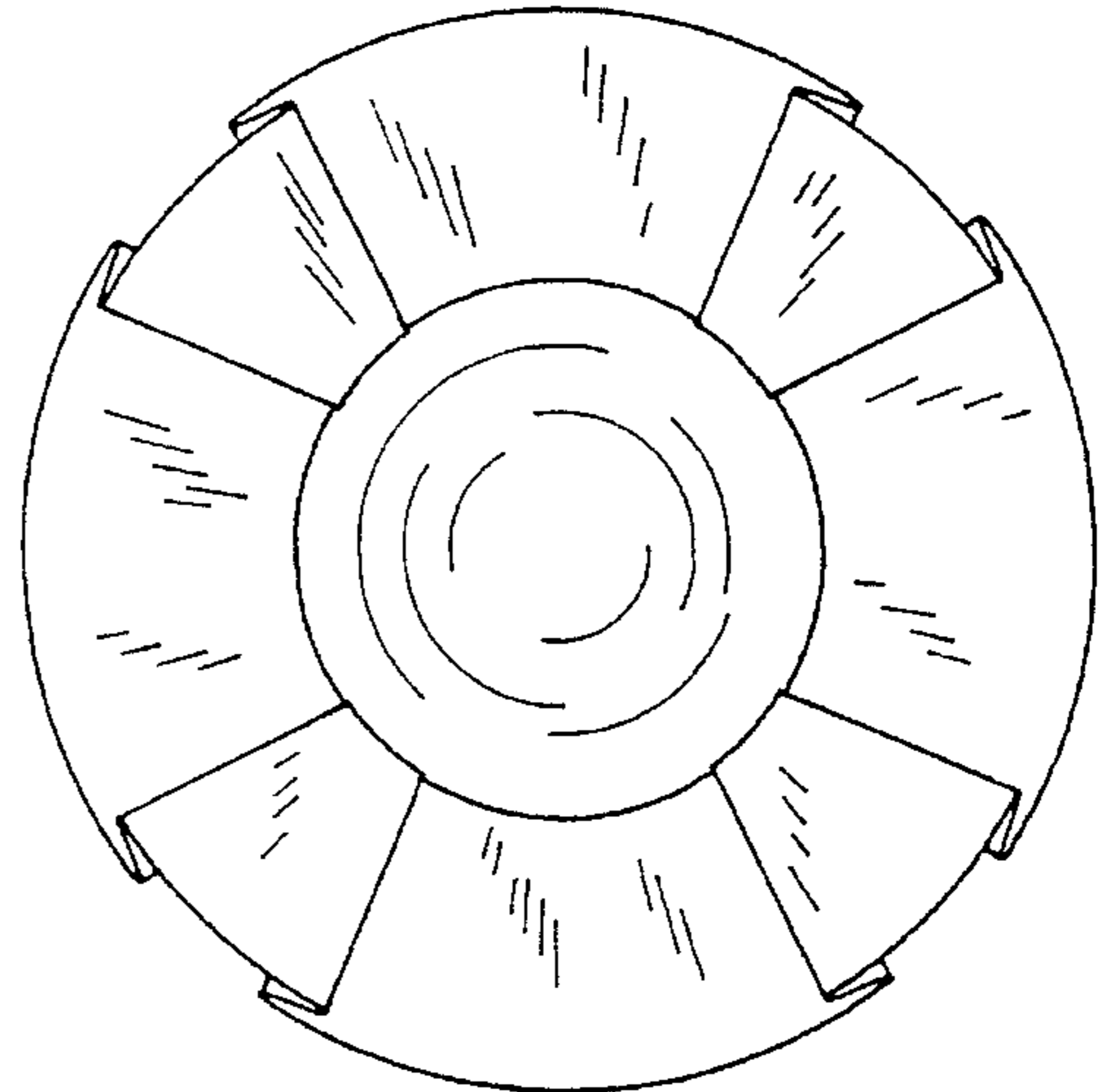

FIG. 10

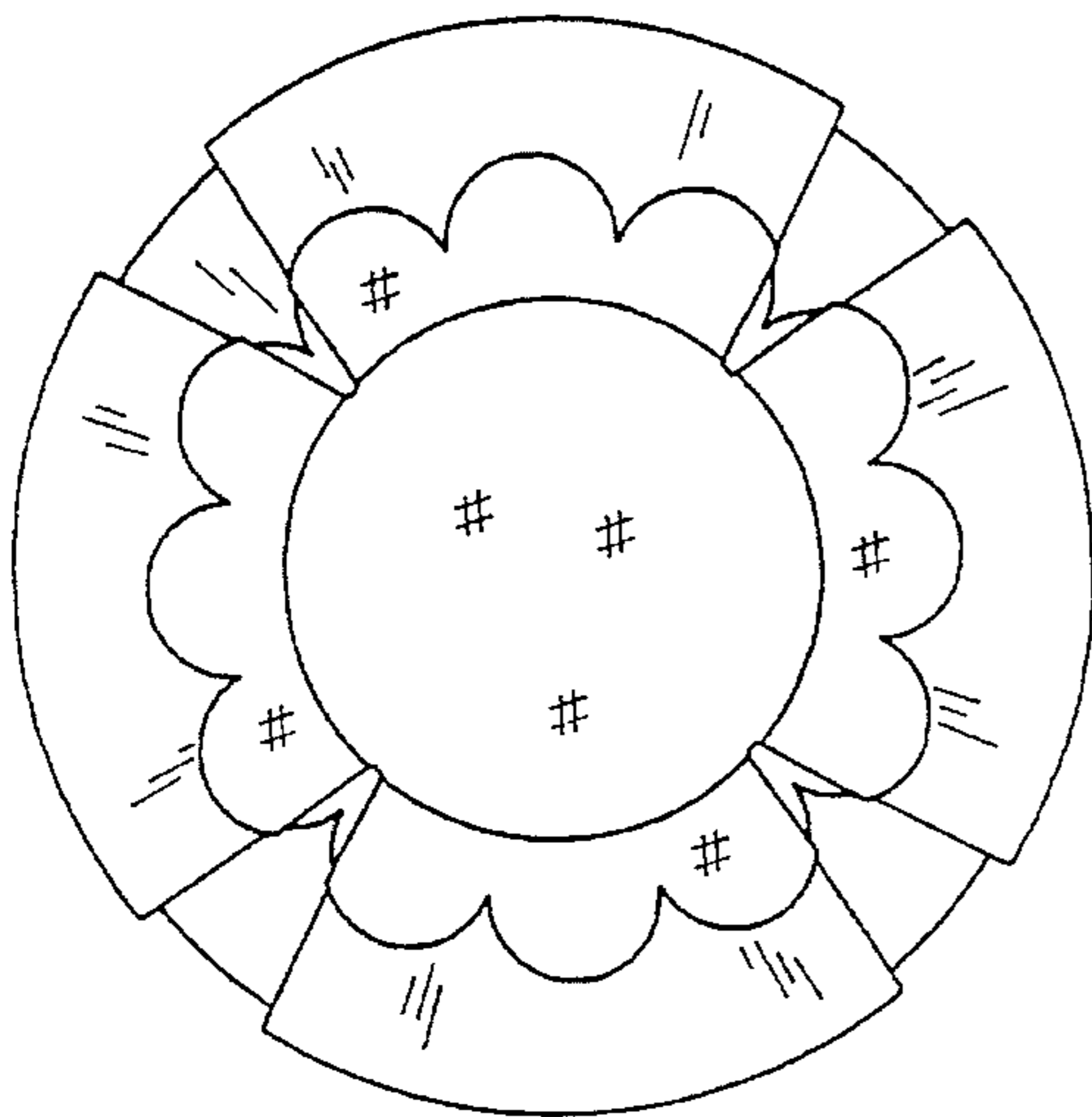

FIG. 11

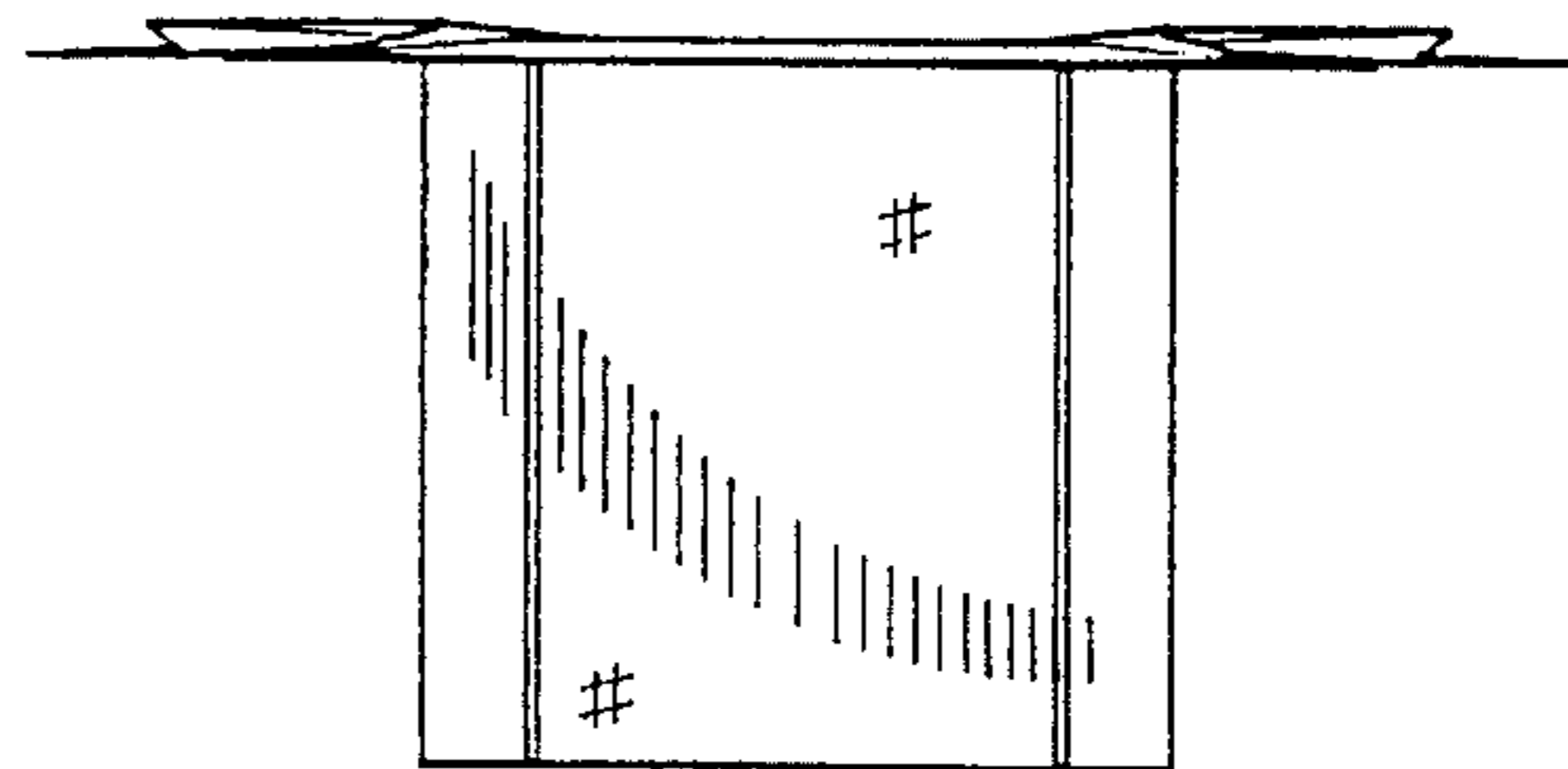
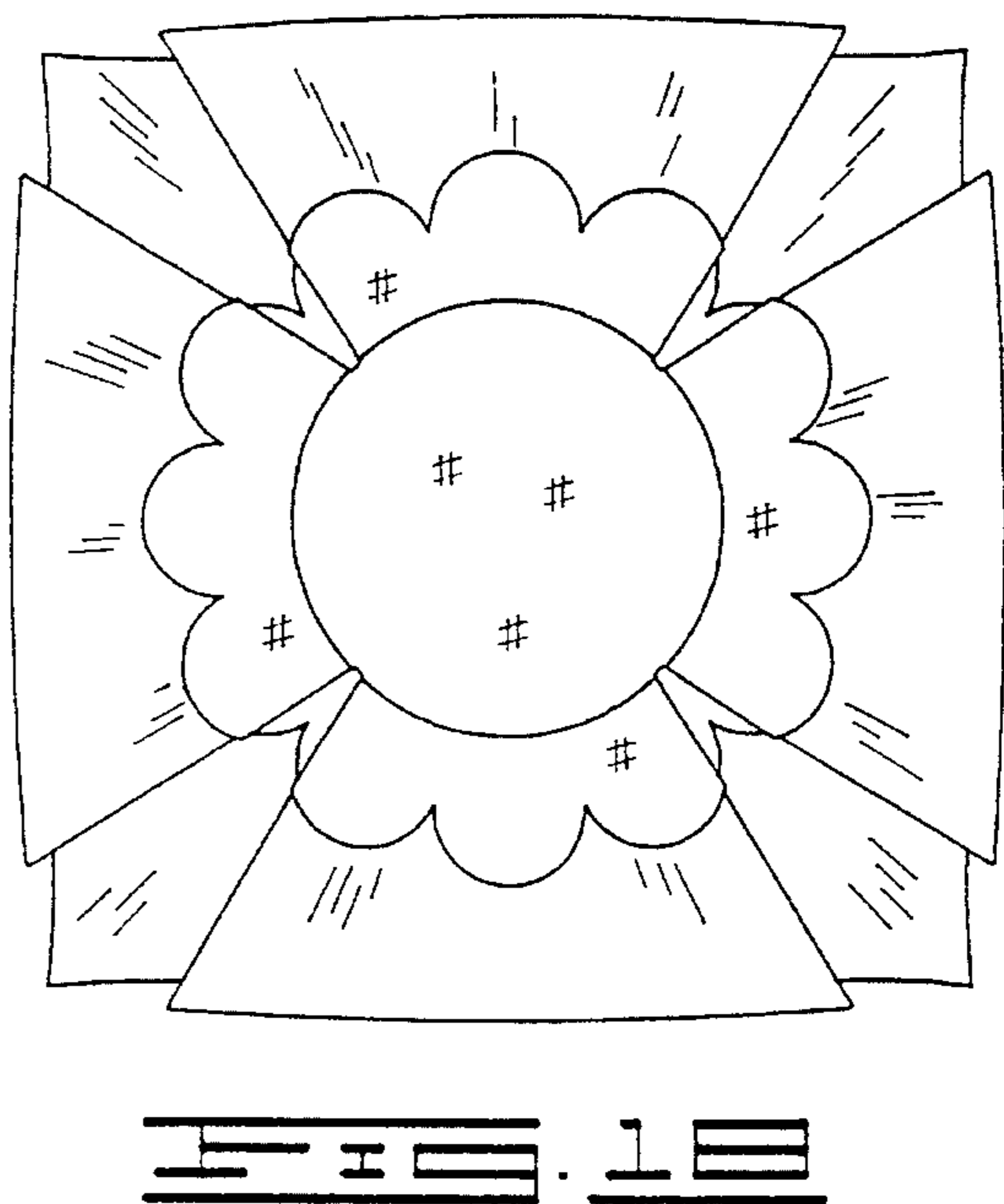
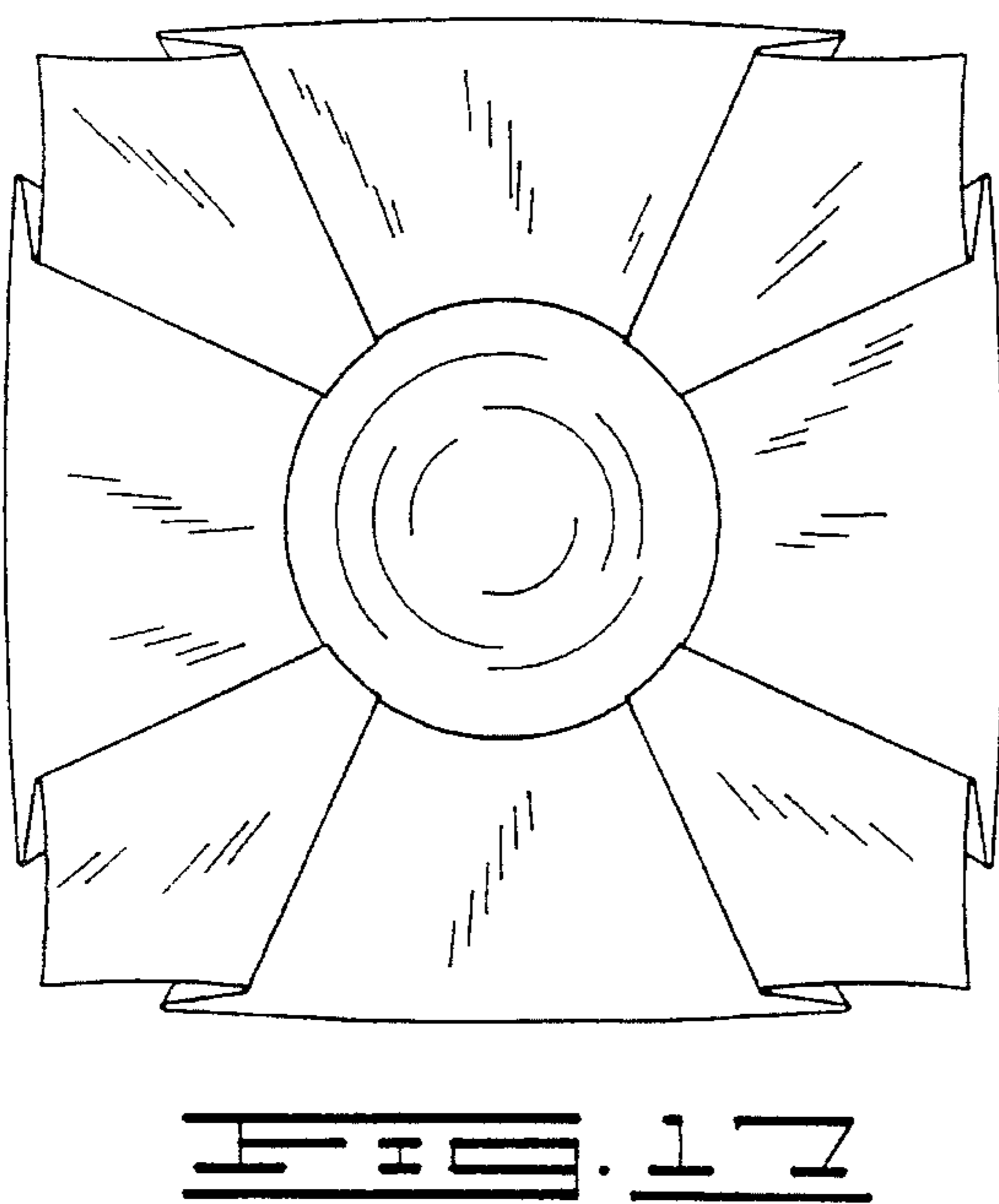
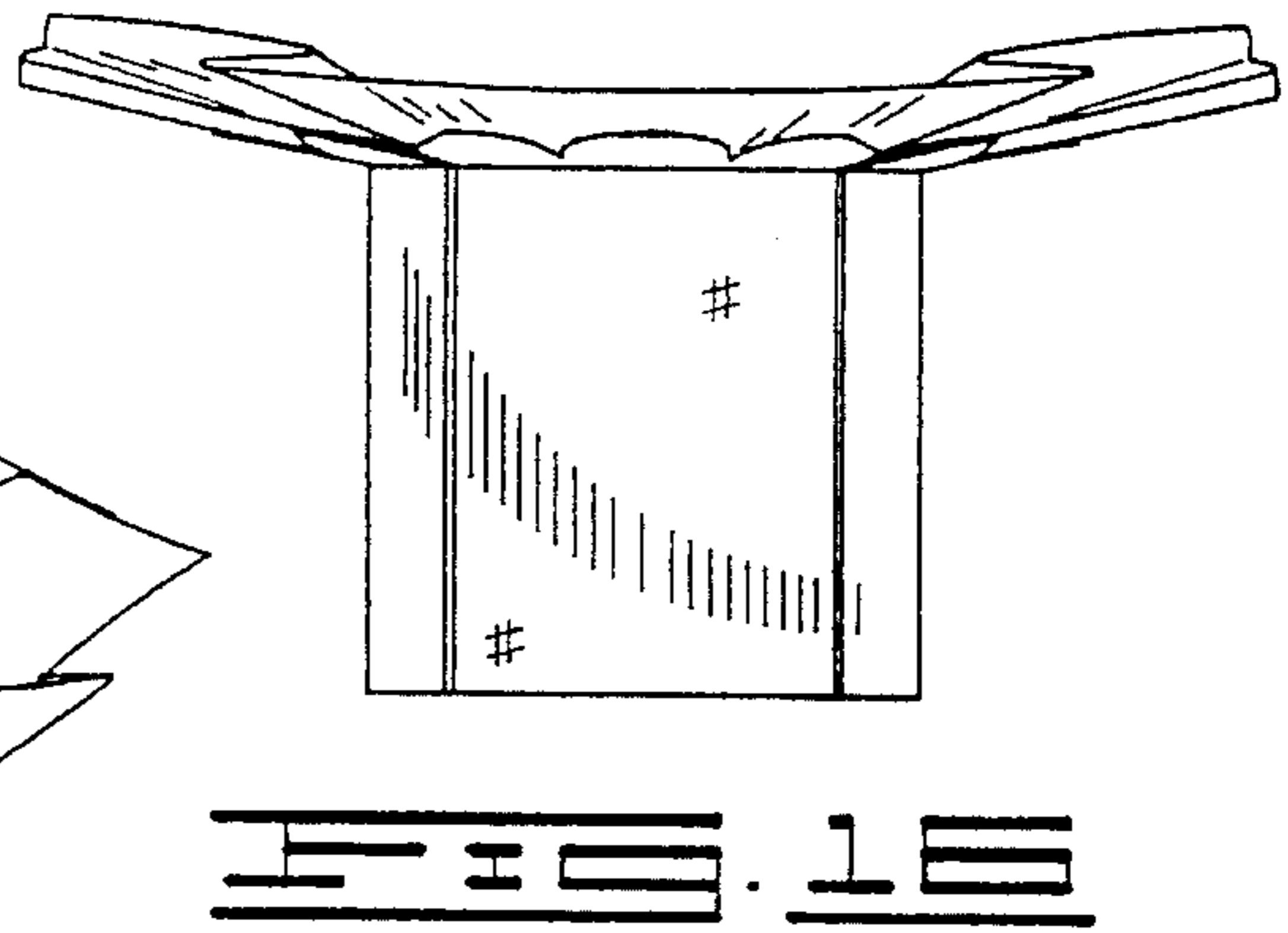
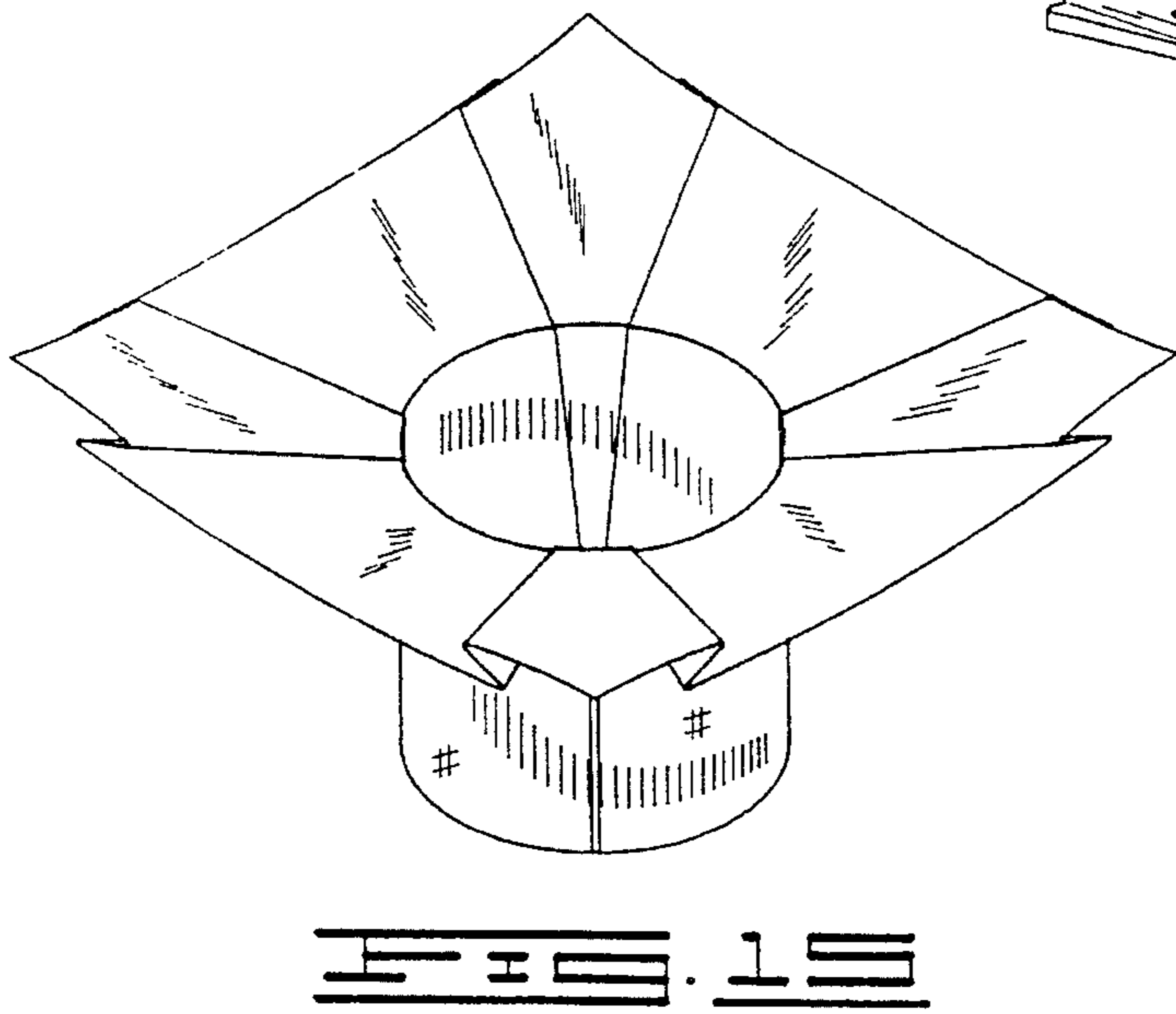
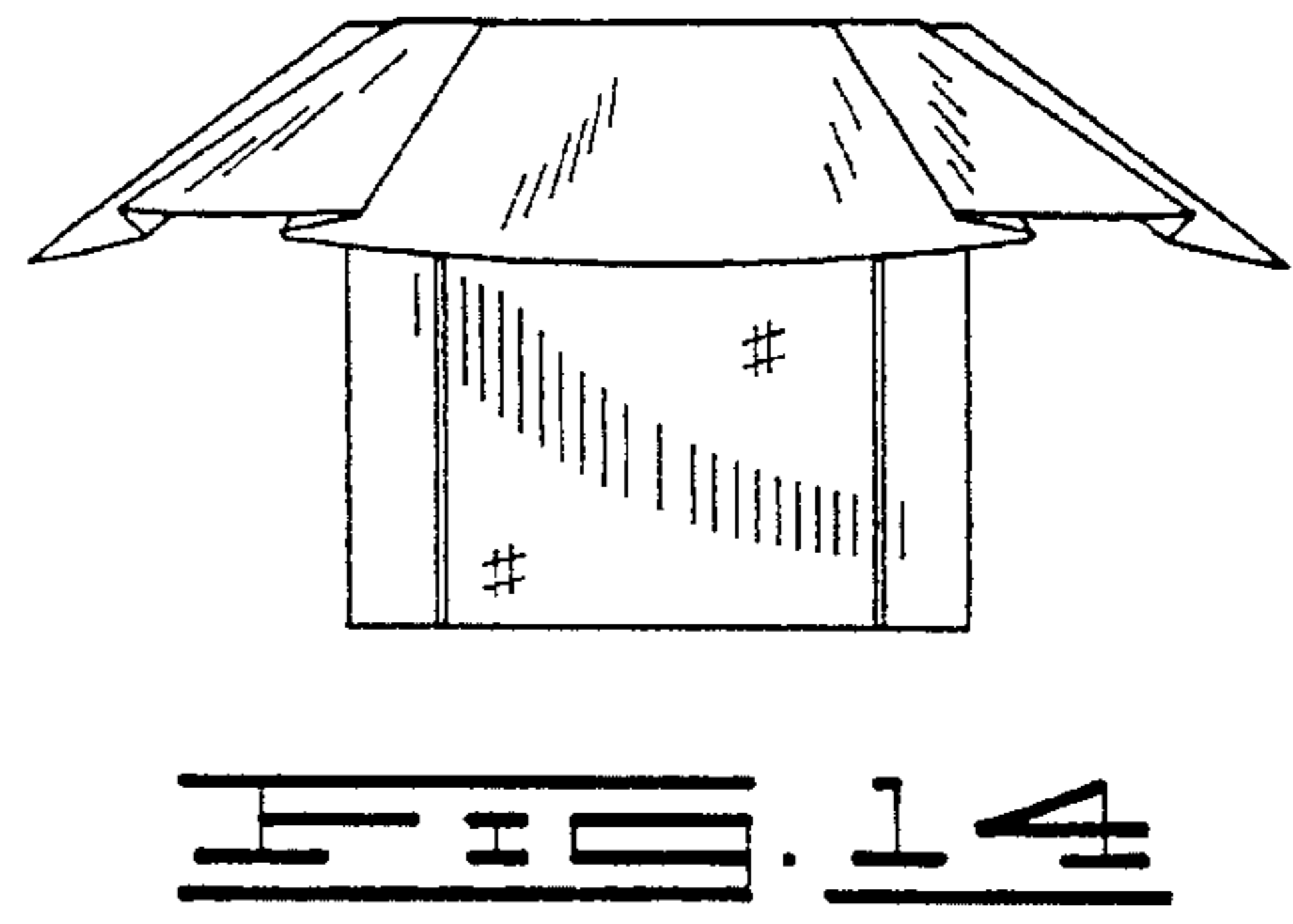
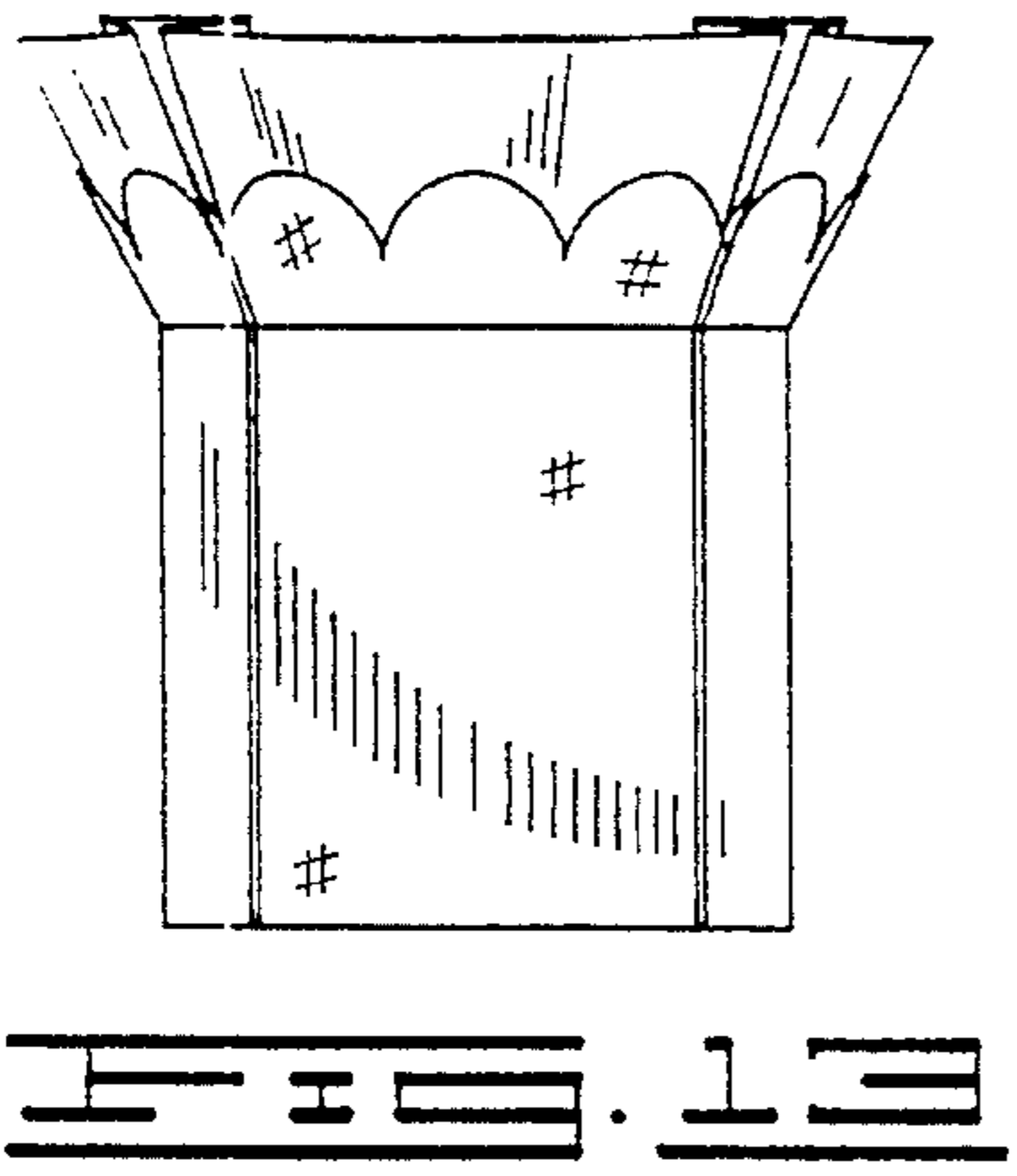

FIG. 12



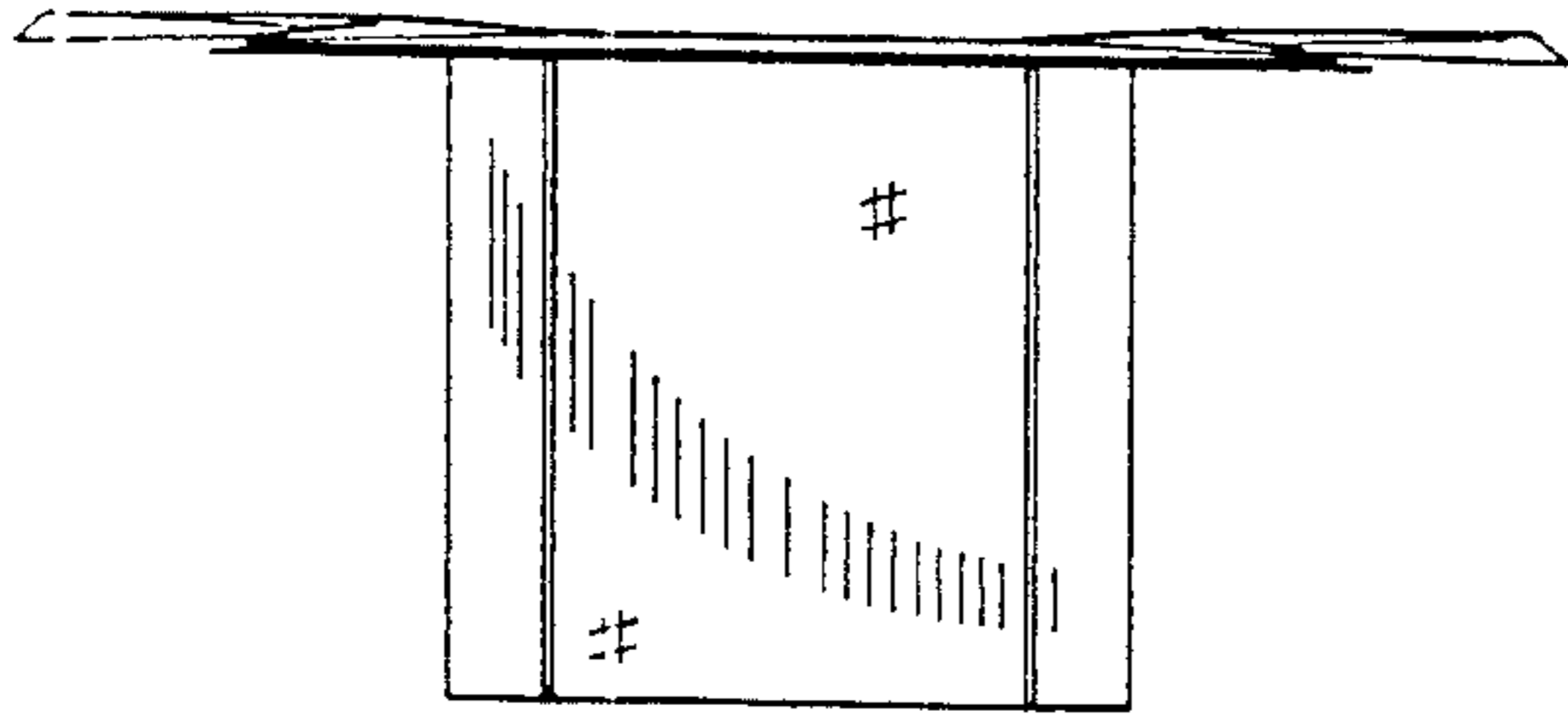

FIG. 19

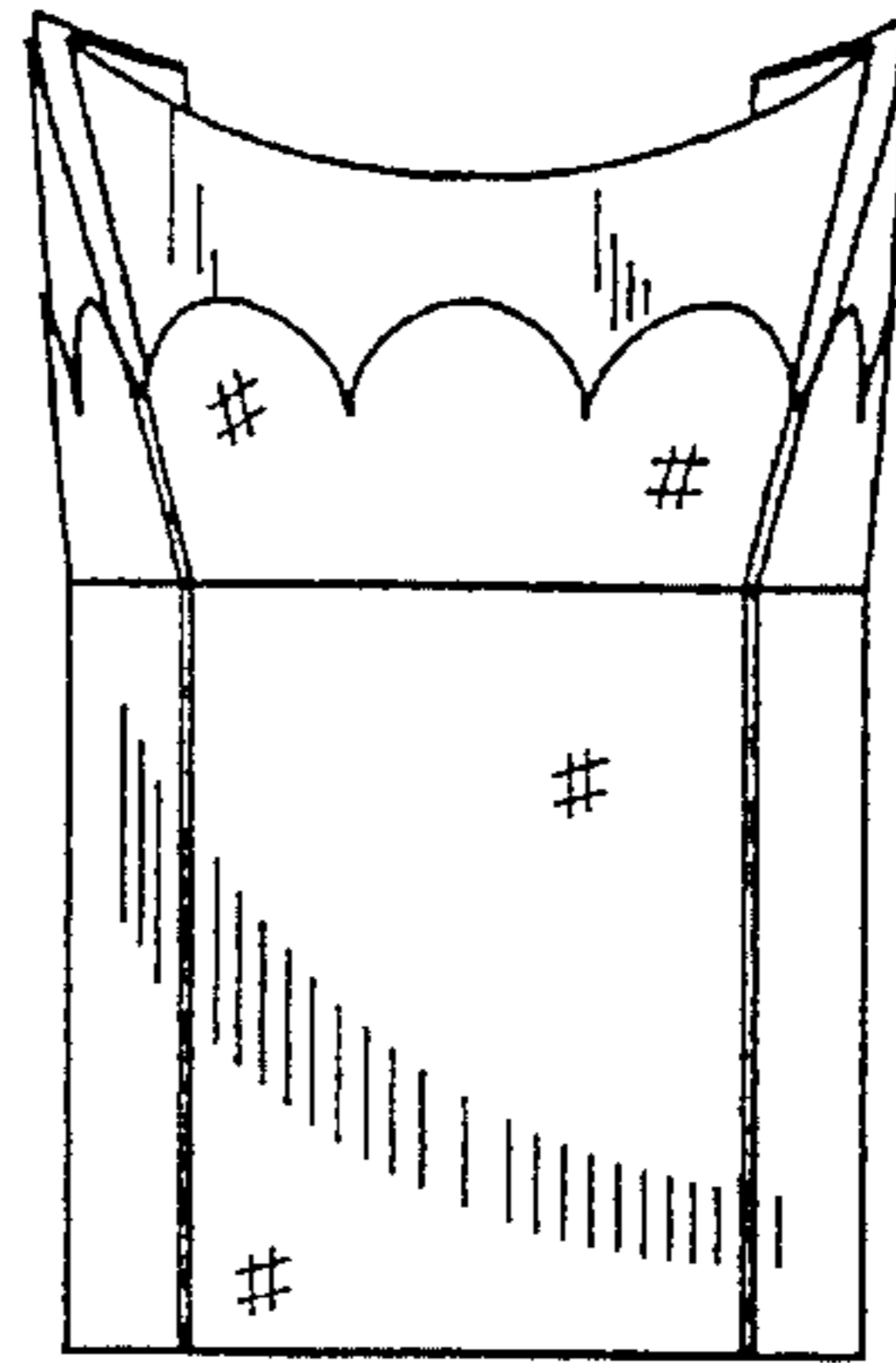

FIG. 20

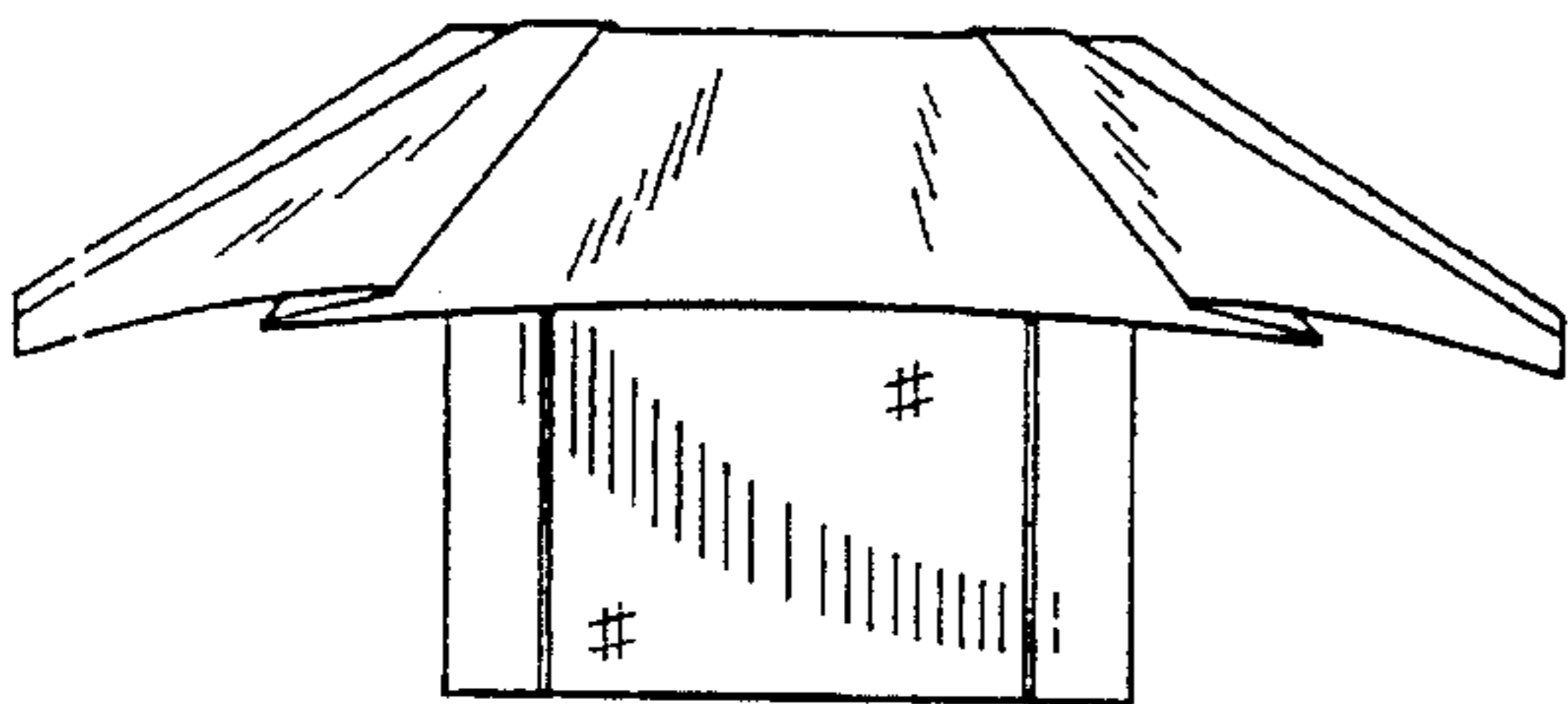

FIG. 21

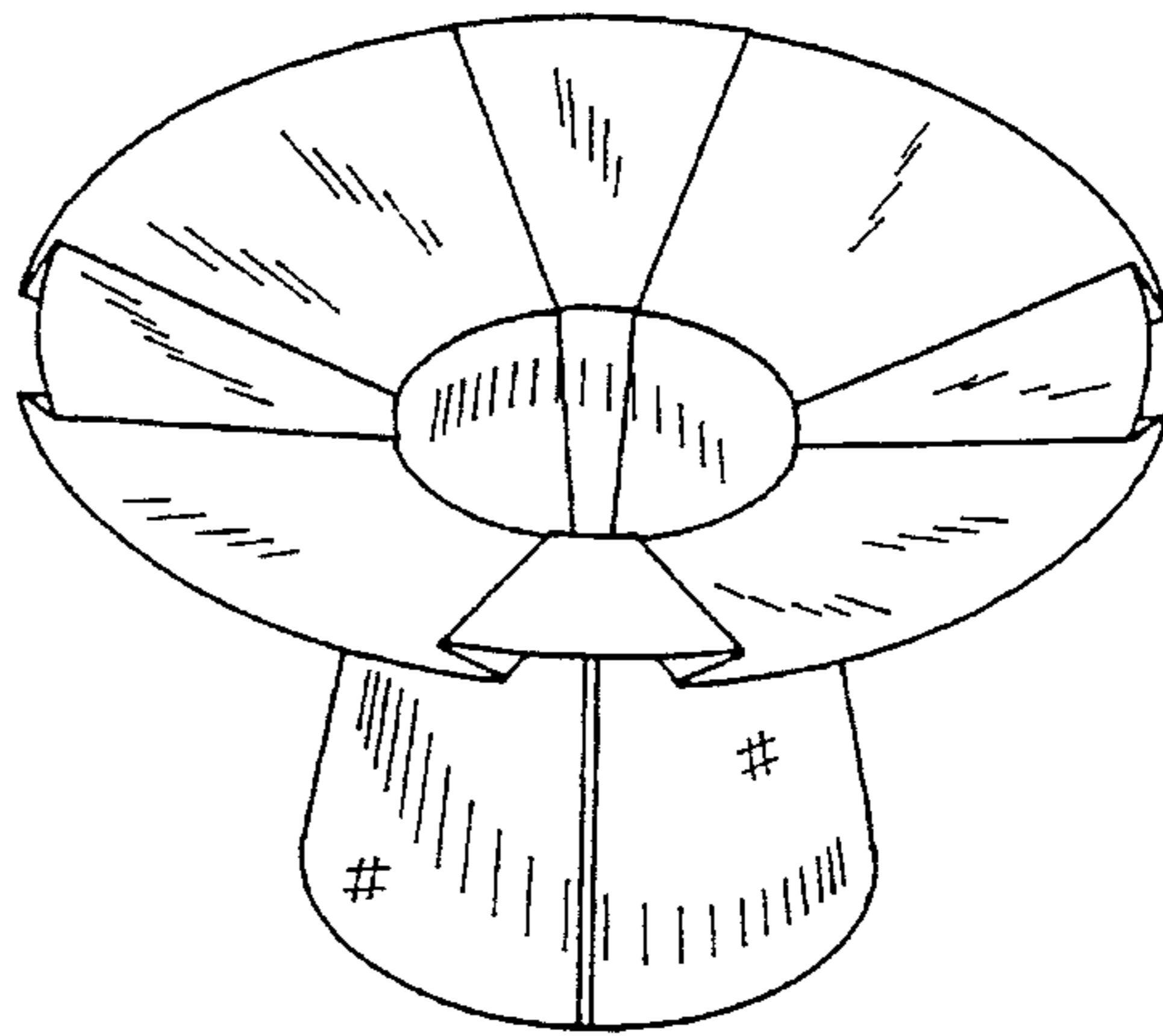

FIG. 22

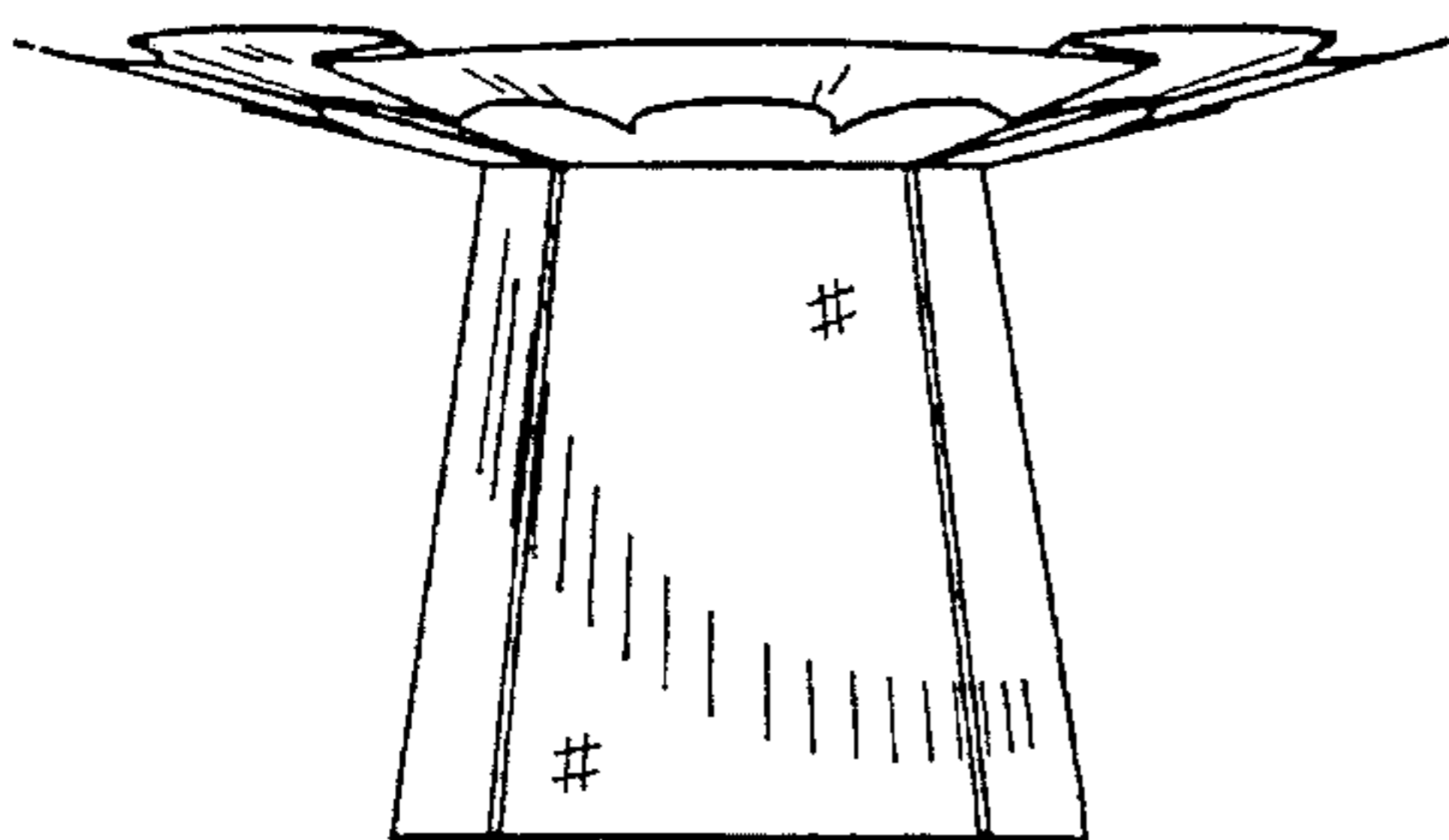

FIG. 23

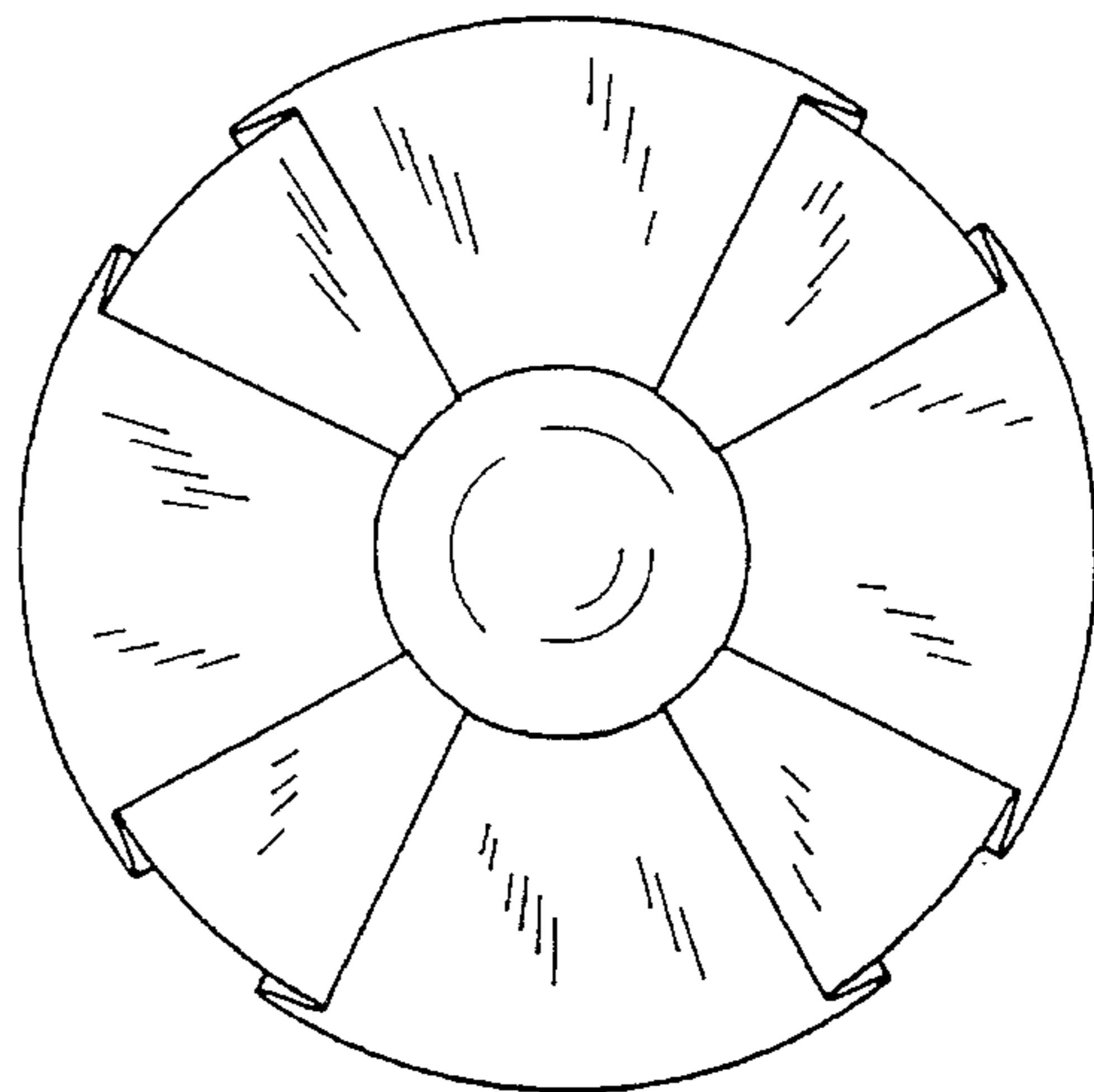

FIG. 24



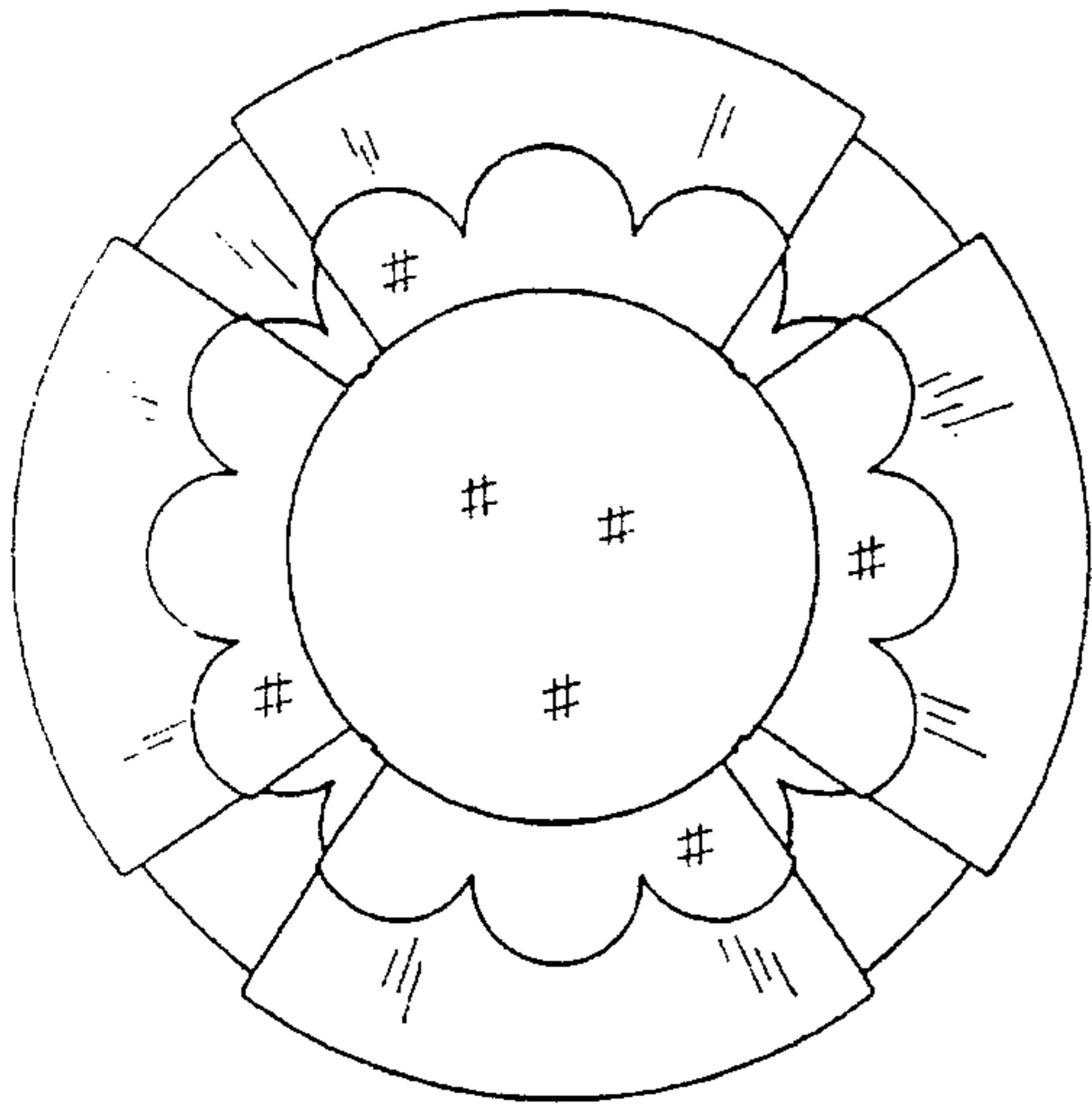

FIG. 25

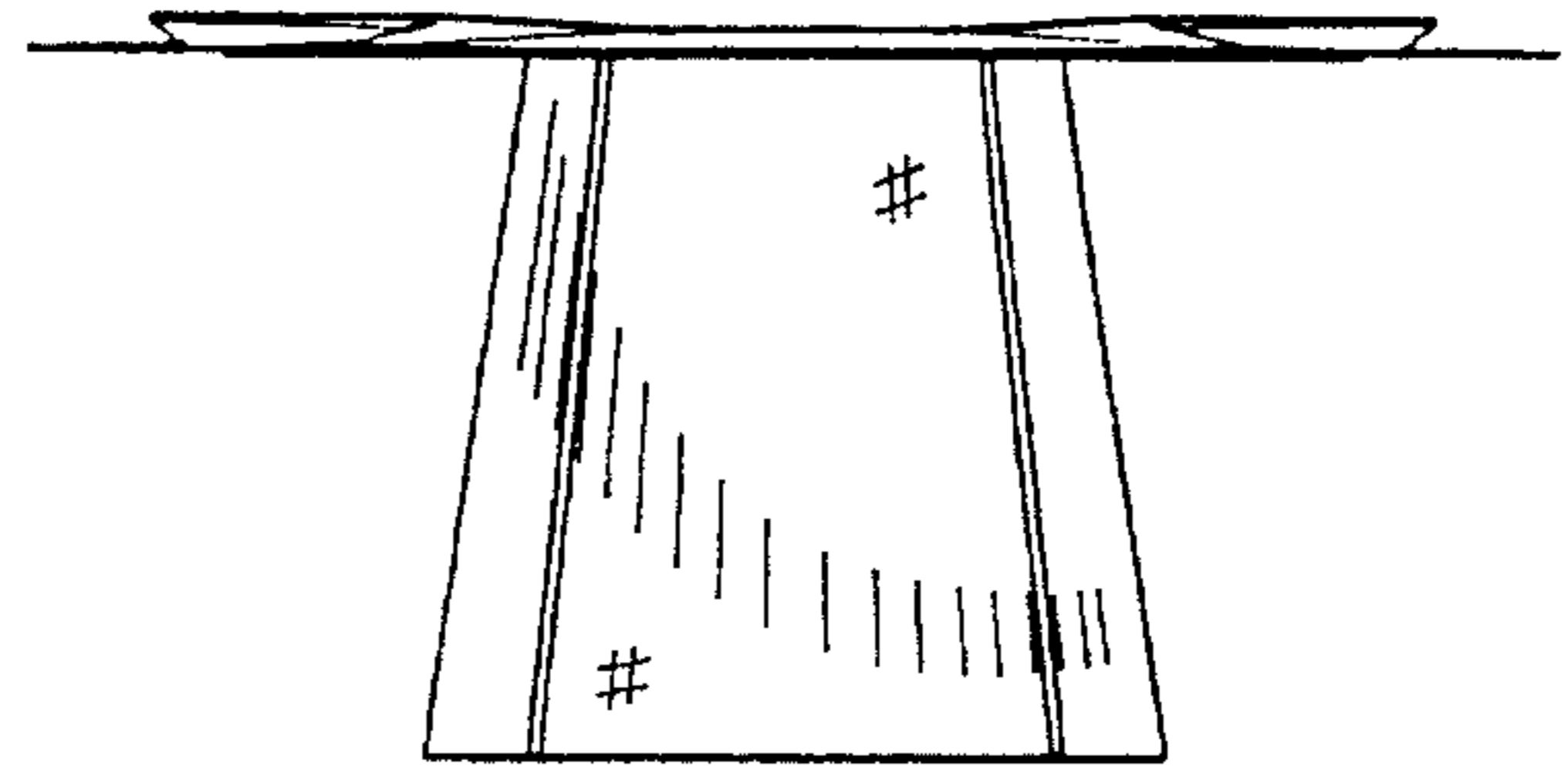

FIG. 26

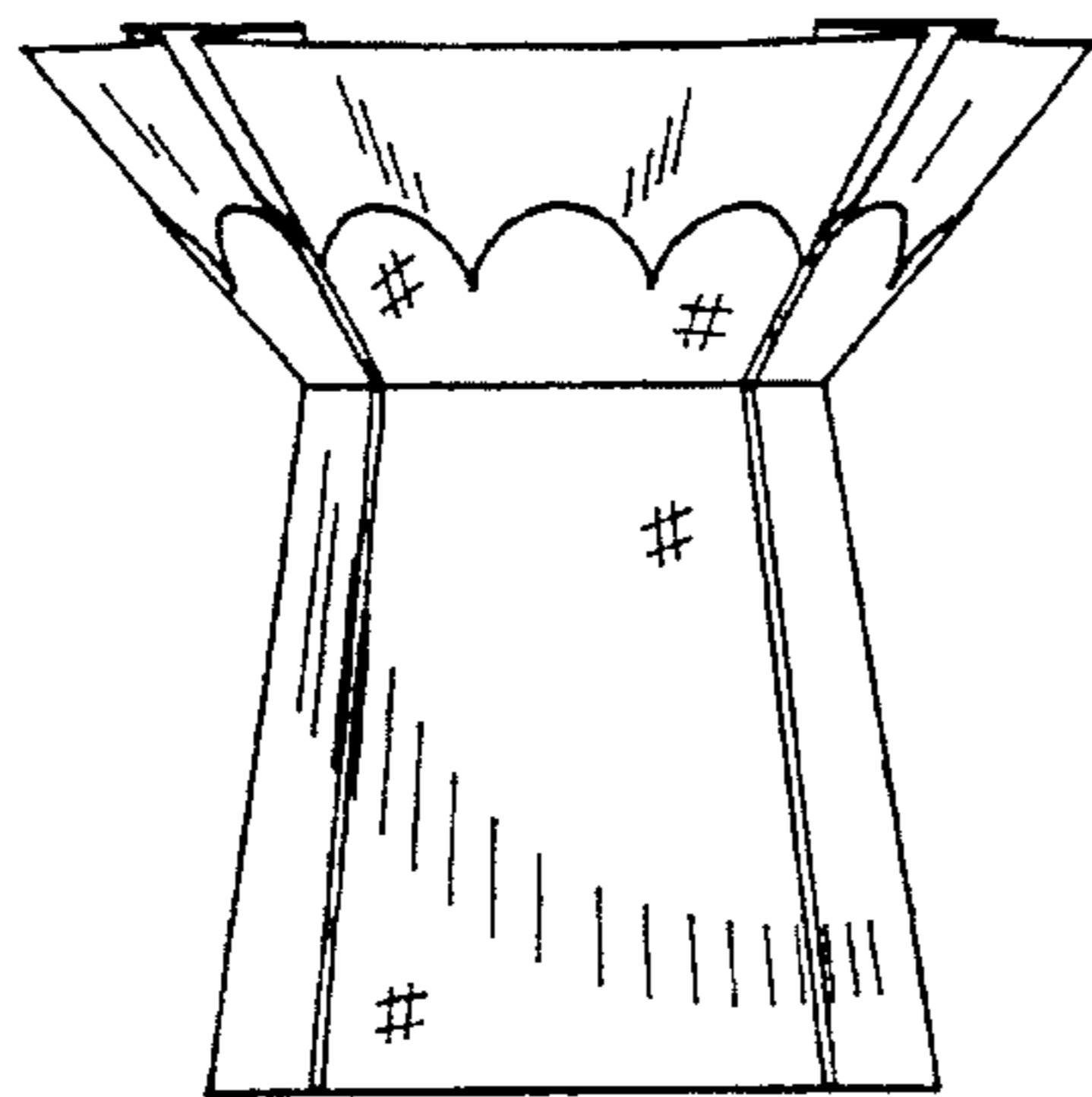

FIG. 27

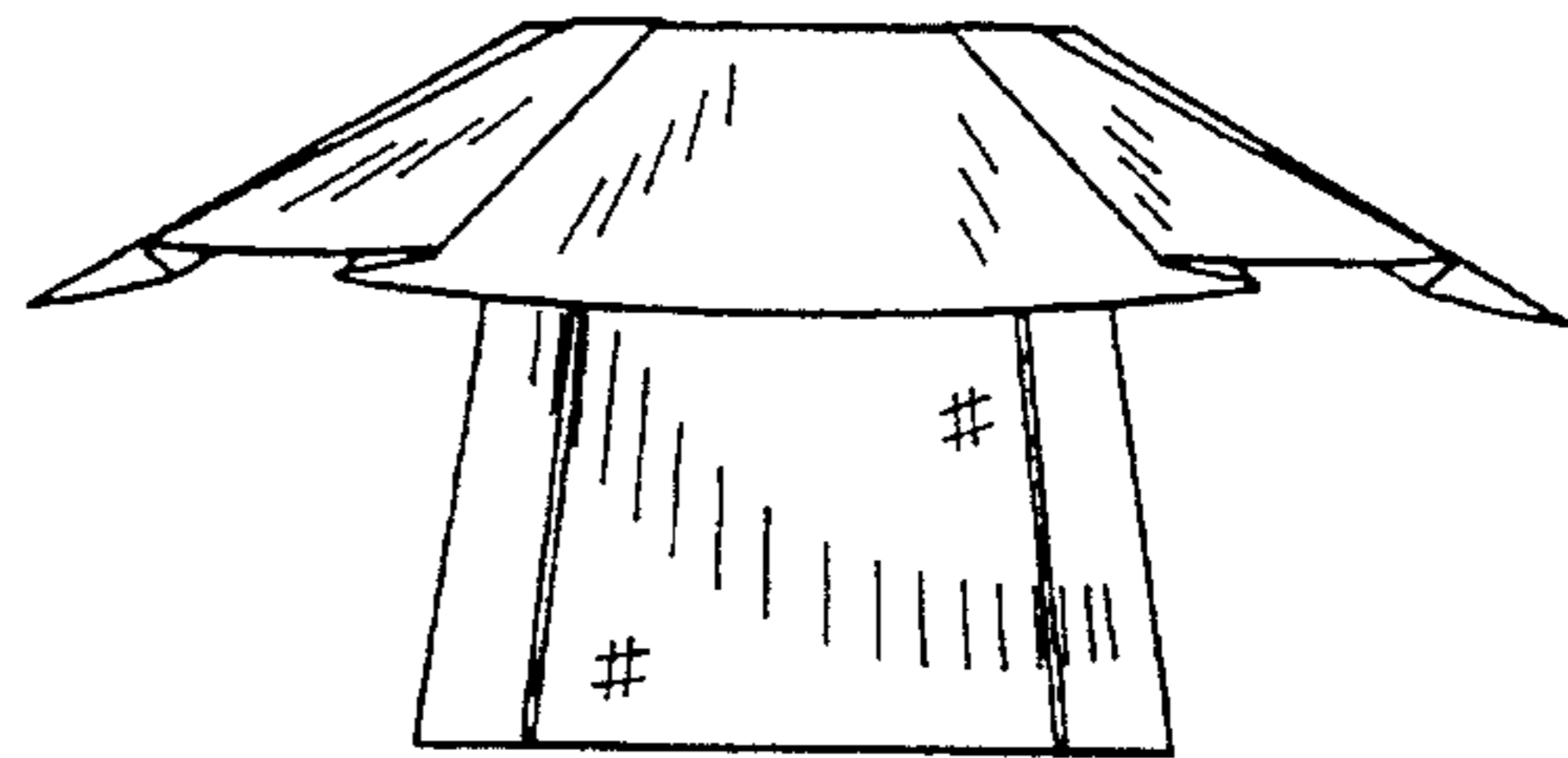

FIG. 28

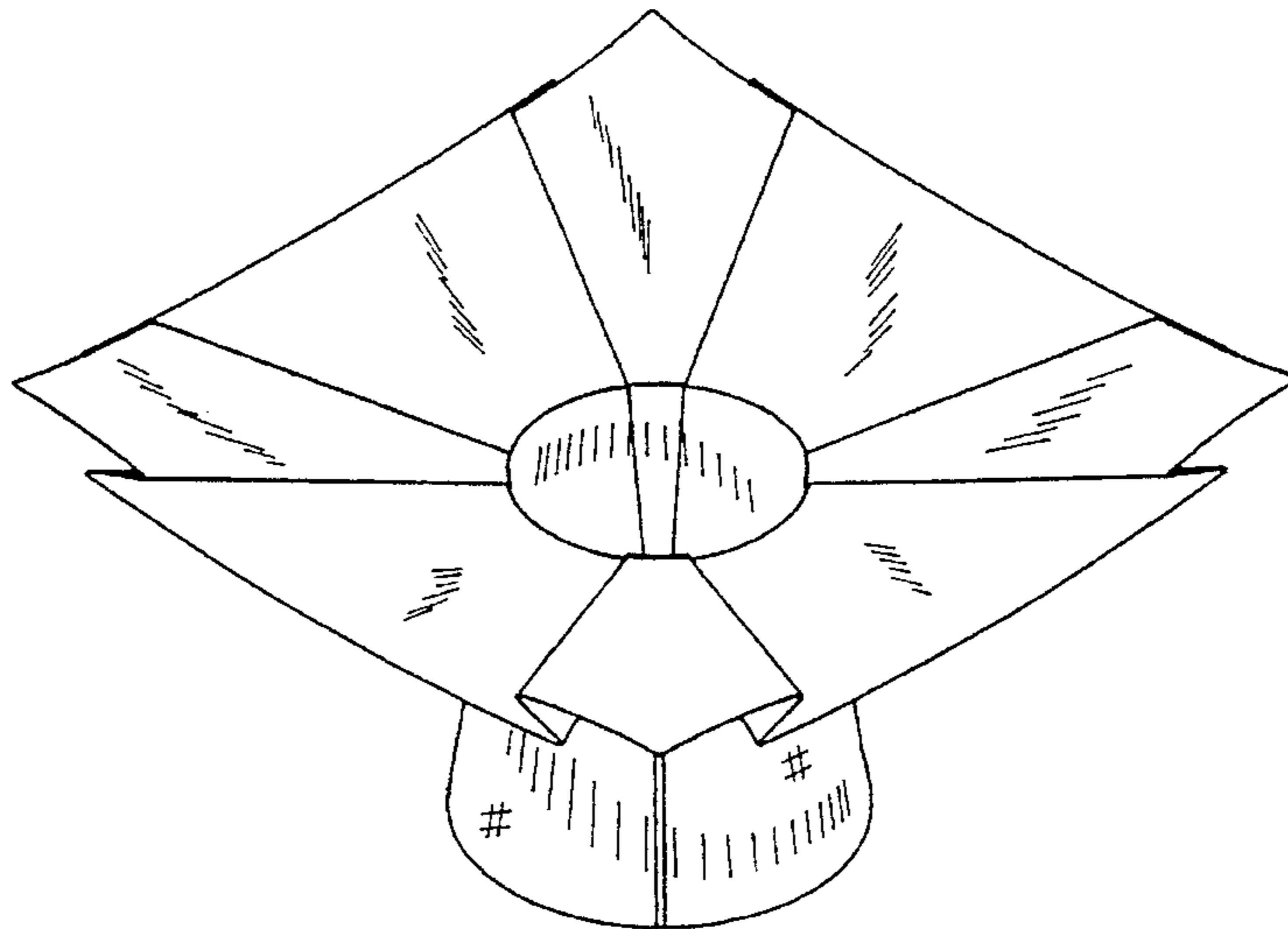

FIG. 29

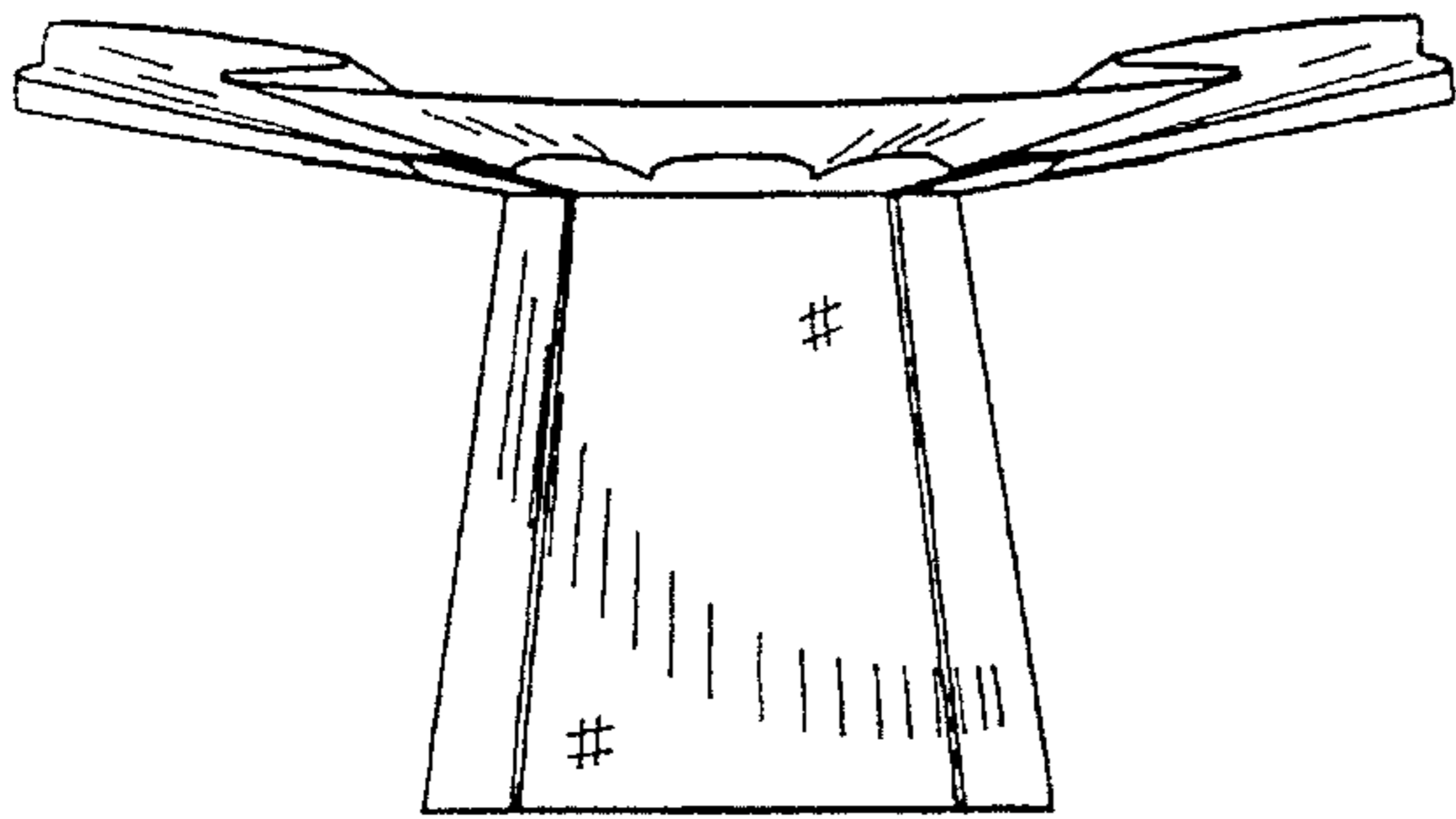

FIG. 30

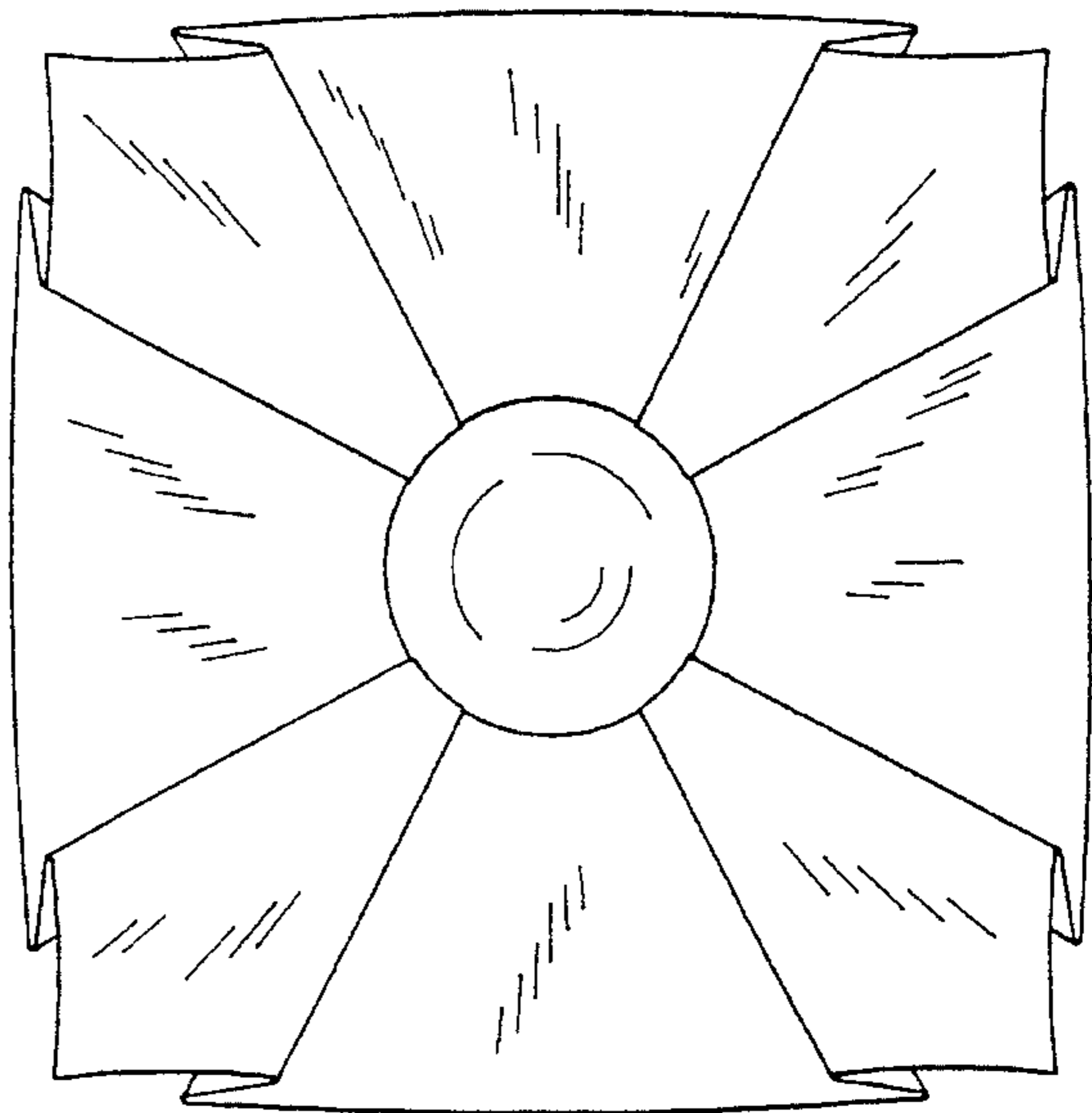

FIG. 31

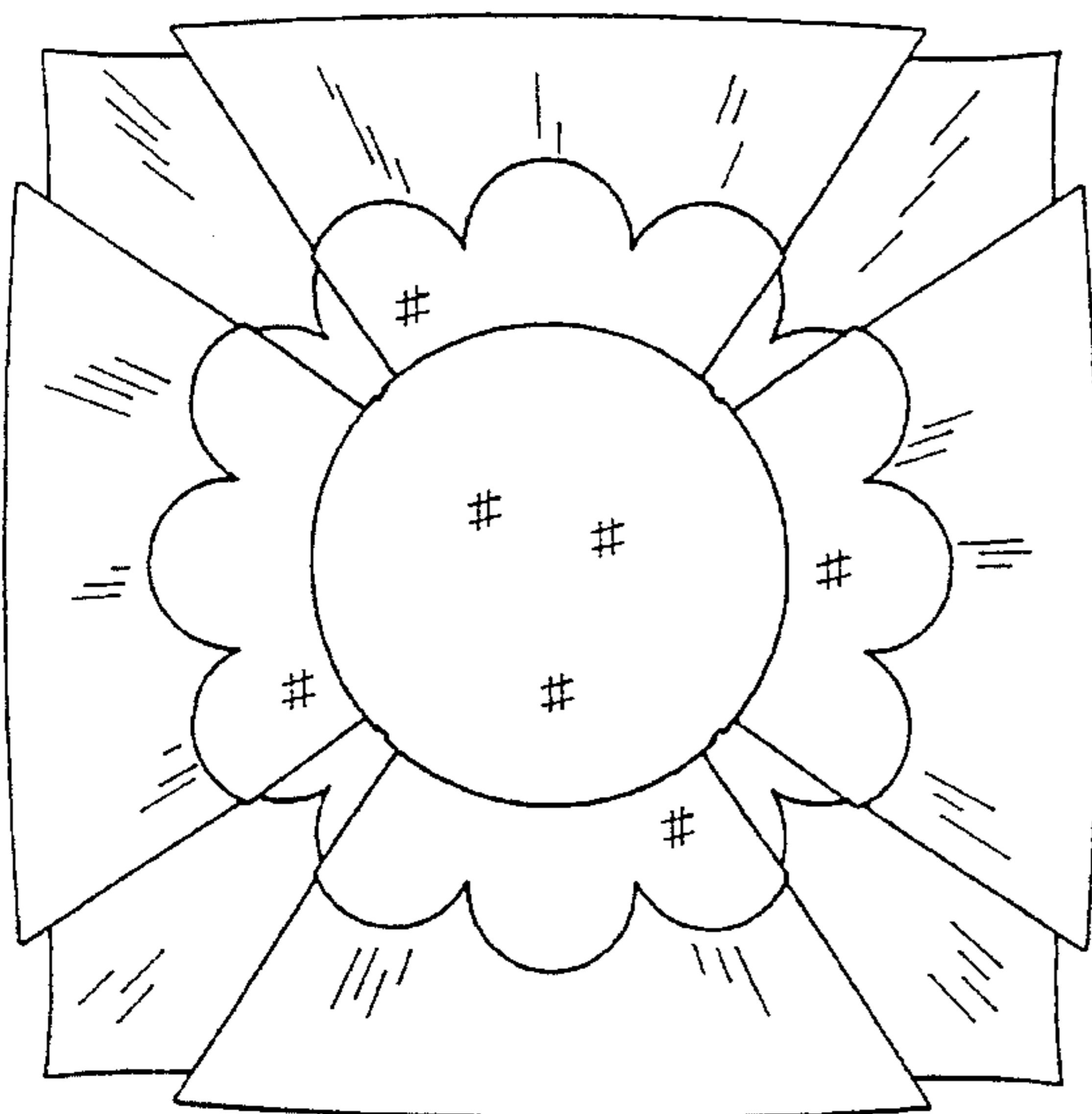

FIG. 32

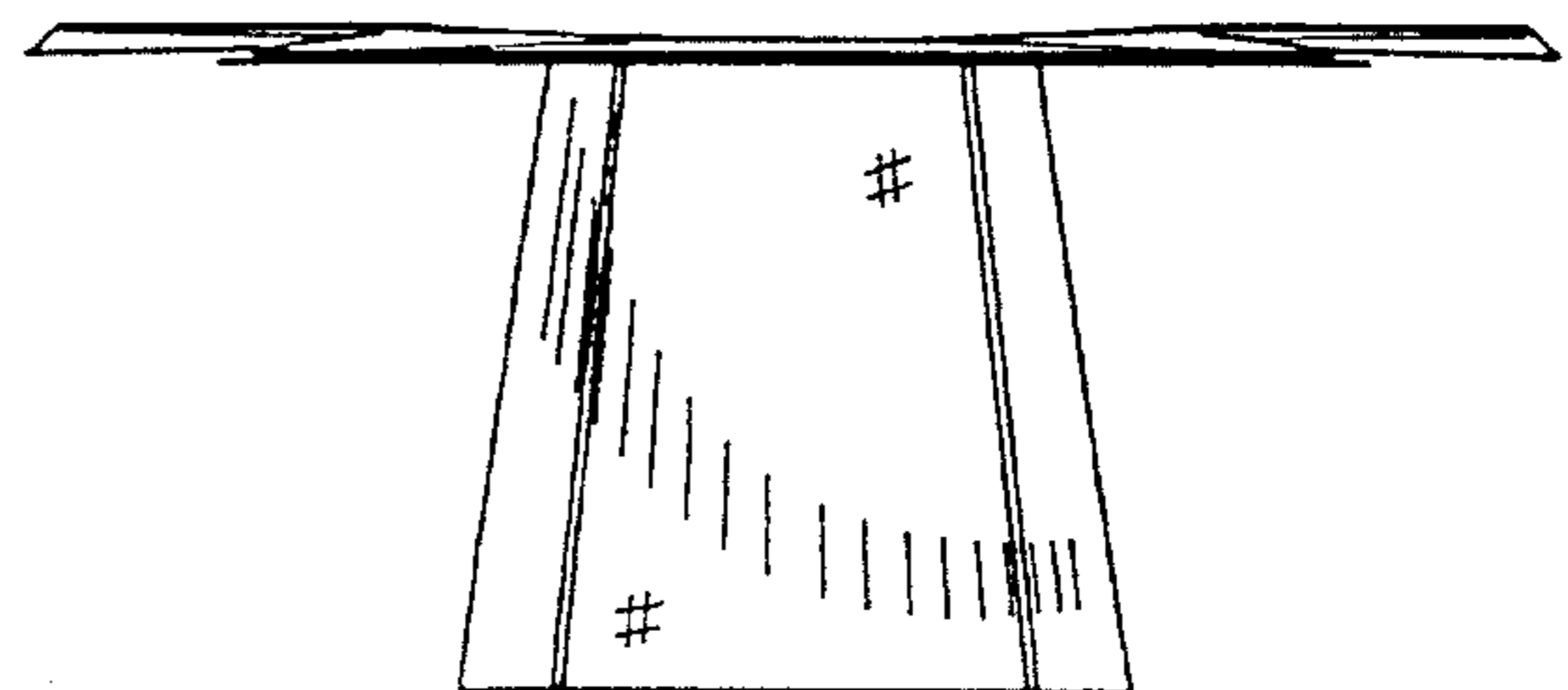

FIG. 33

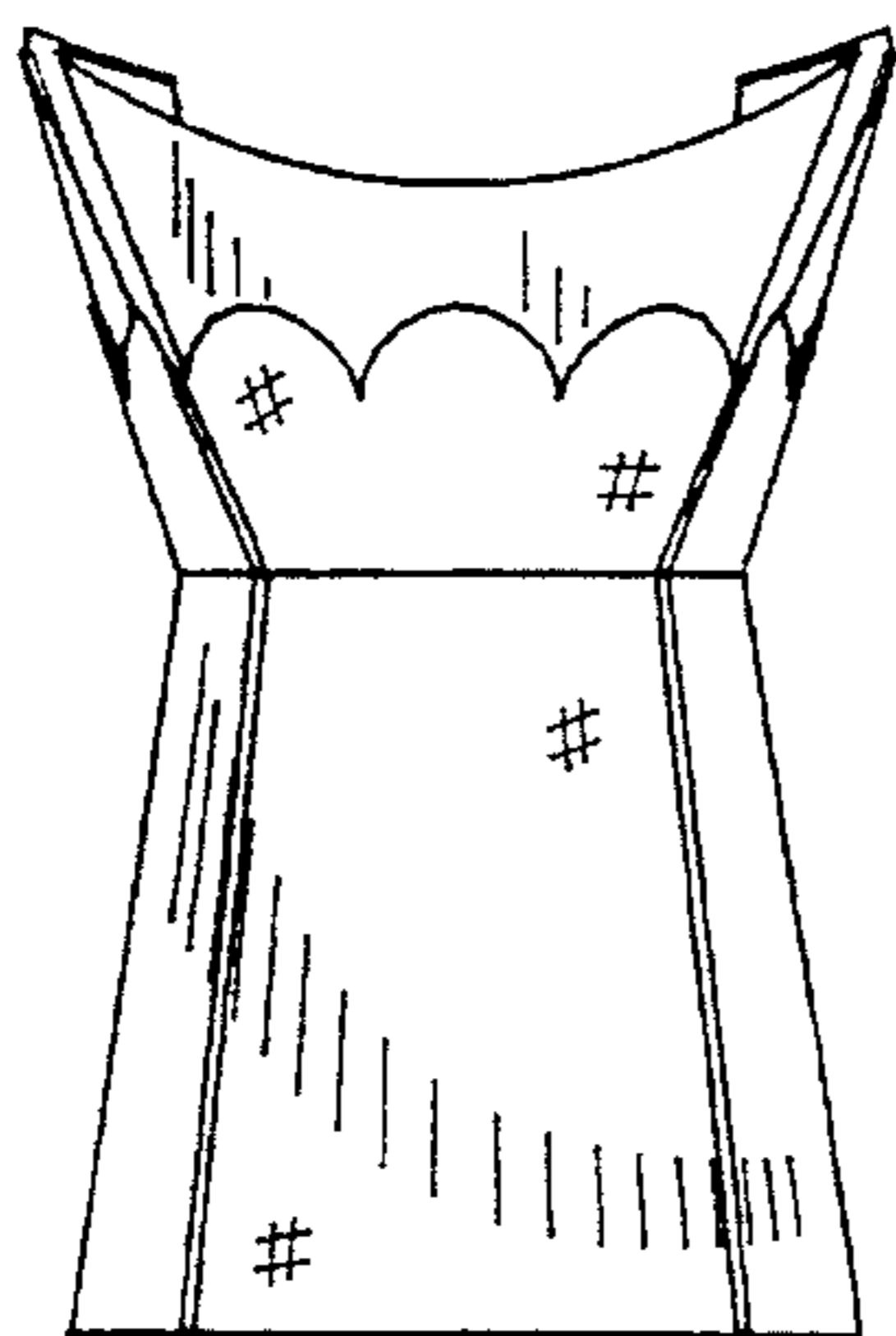

FIG. 34

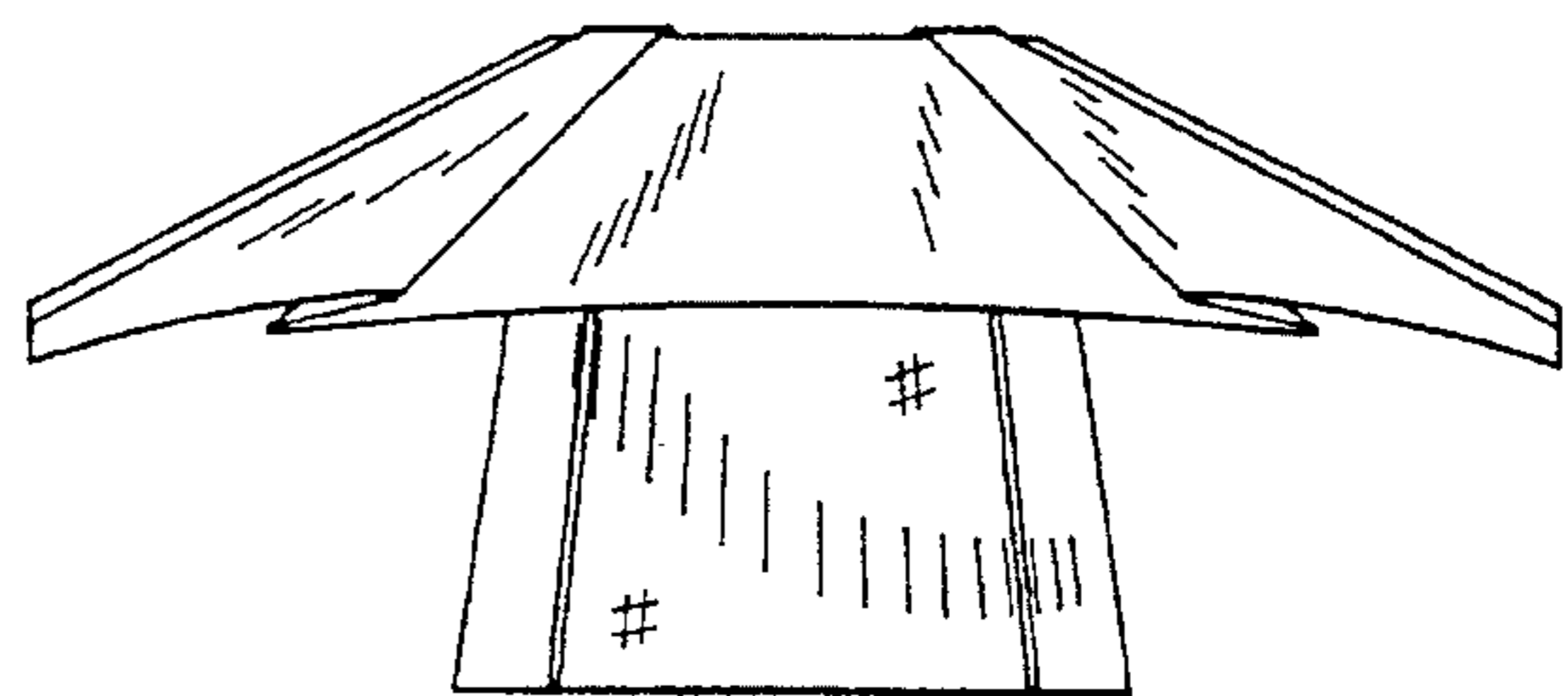

FIG. 35



UNITED STATES PATENT AND TRADEMARK OFFICE  
**CERTIFICATE OF CORRECTION**

PATENT NO. : Des. 371,318  
DATED : July 2, 1996  
INVENTOR(S) : Donald E. Weder et al.

It is certified that error appears in the above-identified patent and that said Letters Patent is hereby corrected as shown below:

On the title page, Item [73] Assignees: should read as follows

-- Trust International, Inc.;  
Southpac Trust International, Inc., --.

Signed and Sealed this  
Seventh Day of October, 1997

*Attest:*



BRUCE LEHMAN

*Attesting Officer*

*Commissioner of Patents and Trademarks*

UNITED STATES PATENT AND TRADEMARK OFFICE  
**CERTIFICATE OF CORRECTION**

PATENT NO. : Des. 371,318  
DATED : July 2, 1996  
INVENTOR(S) : Donald E. Weder et al.

It is certified that error appears in the above-identified patent and that said Letters Patent is hereby corrected as shown below:

On the title page, Item [73] Assignee: should read as follows:  
--The Family Trust U/T/A; Southpac Trust International, Inc.--

This certificate supersedes Certificate of Correction issued October 7, 1997.

Signed and Sealed this  
First Day of December, 1998

Attest:



BRUCE LEHMAN

Attesting Officer

Commissioner of Patents and Trademarks