



US00D371312S

United States Patent [19]
Suzuki

[11] **Patent Number: Des. 371,312**

[45] **Date of Patent: **Jul. 2, 1996**

[54] **AUDIBLE SIGNAL FOR ALARM UNITS**

[75] Inventor: **Kazushi Suzuki**, Shizuoka, Japan

[73] Assignee: **Star Micronics Co., Ltd.**, Shizuoka, Japan

[**] Term: **14 Years**

[21] Appl. No.: **41,633**

[22] Filed: **Jul. 20, 1995**

[30] **Foreign Application Priority Data**

Feb. 10, 1995 [JP] Japan 3469/1995

[52] **U.S. Cl.** **D10/116; D10/106; D14/240**

[58] **Field of Search** D10/104, 106, D10/116, 118, 121; D13/184, 199; D14/140, 240, 100, 107; 340/392.1, 392.3, 392.2, 392.5, 396.1, 384.6, 384.7, 384.72, 388.6; 361/600, 679, 724, 829

[56] **References Cited**

U.S. PATENT DOCUMENTS

D. 201,593	7/1965	Stevenson	D10/118
D. 258,577	3/1981	Bottner	D13/184 X
D. 264,196	5/1982	Doggart	D10/118
D. 285,667	9/1986	Tanaka et al.	D10/106
D. 337,993	8/1993	Garthwaite et al.	D13/184 X
D. 339,544	9/1993	Sone	D10/116
2,984,832	5/1961	Gilman, III et al.	340/392.1
3,251,056	5/1966	Doggart	340/392.5
4,075,626	2/1978	Sakaguchi et al.	340/388.6
4,115,770	9/1978	Kanayawa	340/392.3
4,303,908	12/1981	Enemark et al.	340/384.72 X
4,366,472	12/1982	Ishii	340/392.2

OTHER PUBLICATIONS

Burndy Electronic Products, p. 31, Nov. 1986, center of page connector.

Primary Examiner—Jeffrey Asch
Attorney, Agent, or Firm—Pollock, Vande Sande & Priddy

[57] **CLAIM**

The ornamental design for an audible signal for alarm units, as shown and described.

DESCRIPTION

FIG. 1 is a perspective view of an audible signal for alarm units showing my new design;
 FIG. 2 is a front elevational view thereof;
 FIG. 3 is a rear elevational view thereof;
 FIG. 4 is a top plan view thereof;
 FIG. 5 is a bottom plan view thereof;
 FIG. 6 is a left side elevational view thereof (of which a right side elevational view would be a mirror image);
 FIG. 7 is a cross-sectional view thereof taken on line 7—7 of FIG. 2, an internal mechanism of which is not shown;
 FIG. 8 is a cross-sectional view thereof taken on line 8—8 of FIG. 5, an internal mechanism of which is not shown;
 FIG. 9 is a cross-sectional view thereof taken on line 9—9 of FIG. 5, an internal mechanism of which is not shown; and
 FIG. 10 is a cross-sectional view thereof taken on line 10—10 of FIG. 5 an internal mechanism of which is not shown; and,
 FIG. 11 is a cross-sectional view thereof taken on line 11—11 of FIG. 5, an internal mechanism of which is not shown.

1 Claim, 7 Drawing Sheets

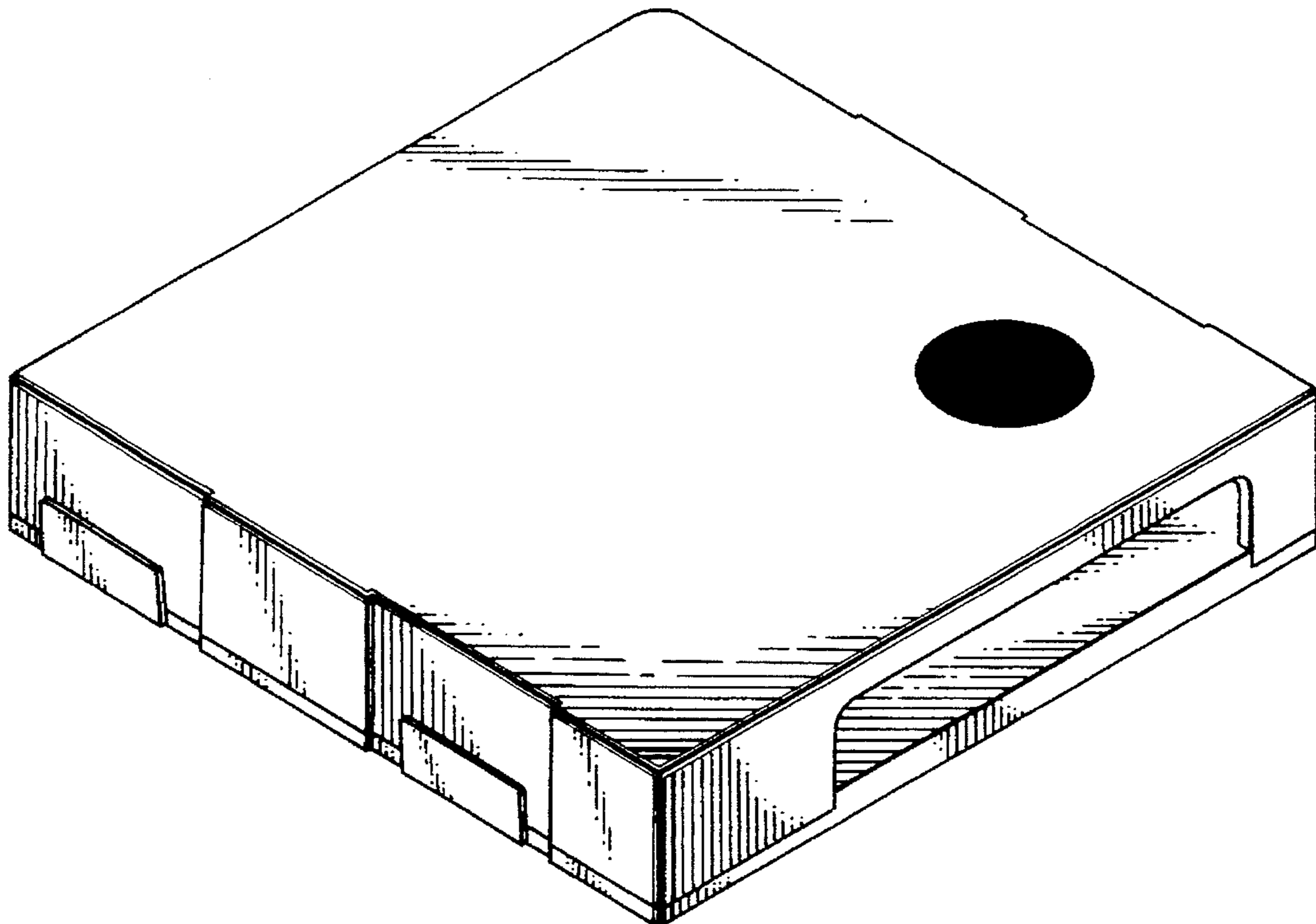

FIG. 1

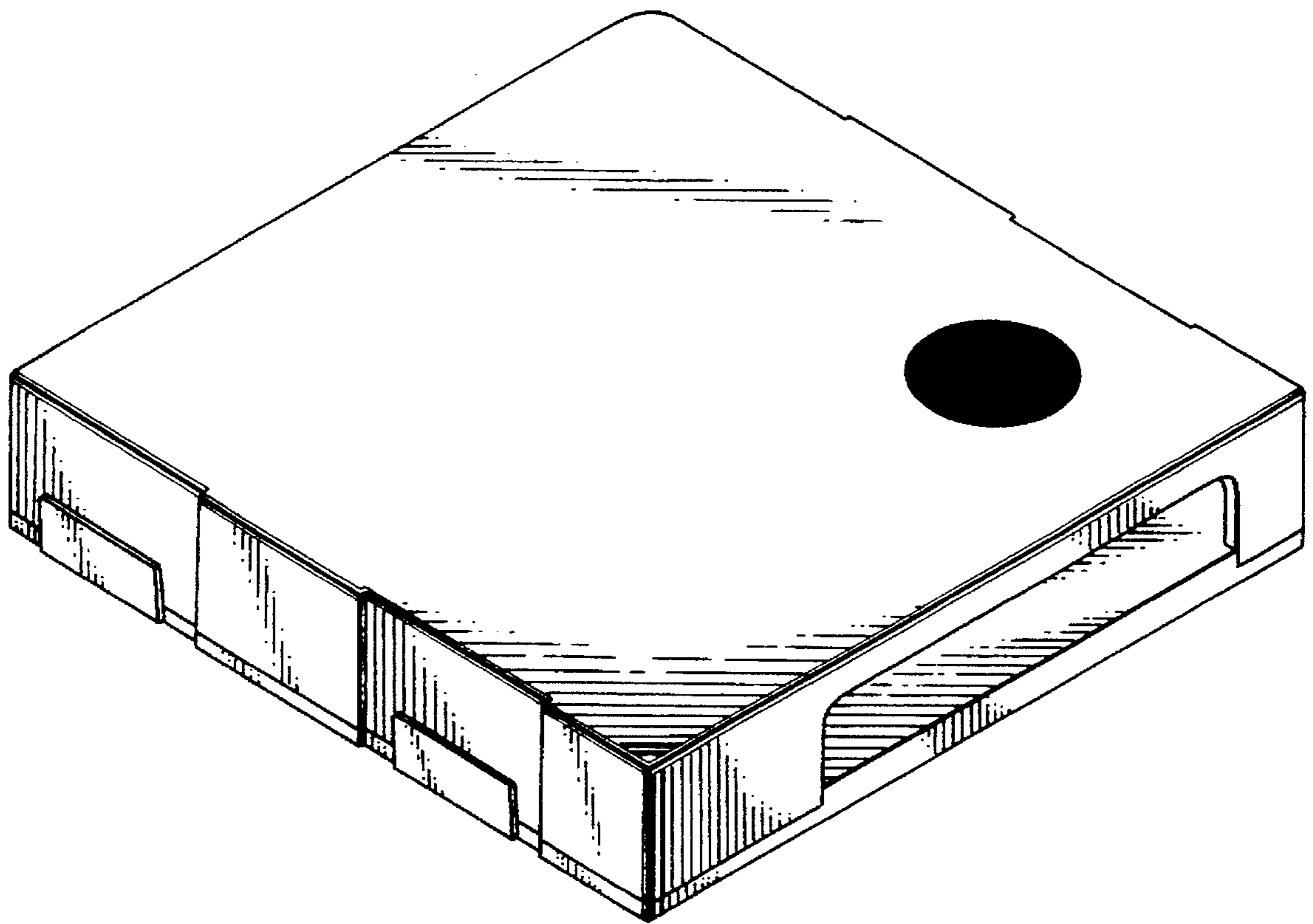

FIG. 2

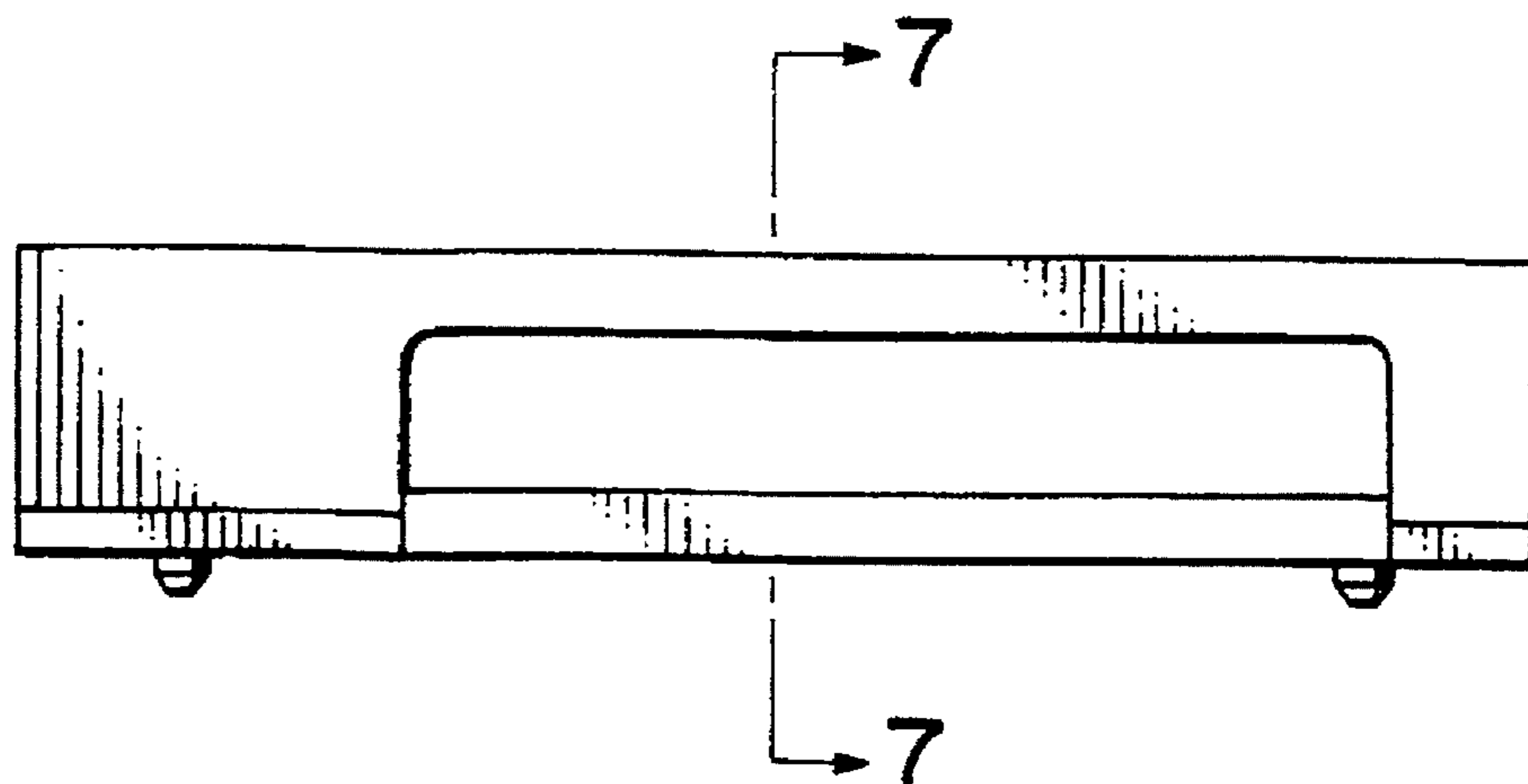

FIG. 3

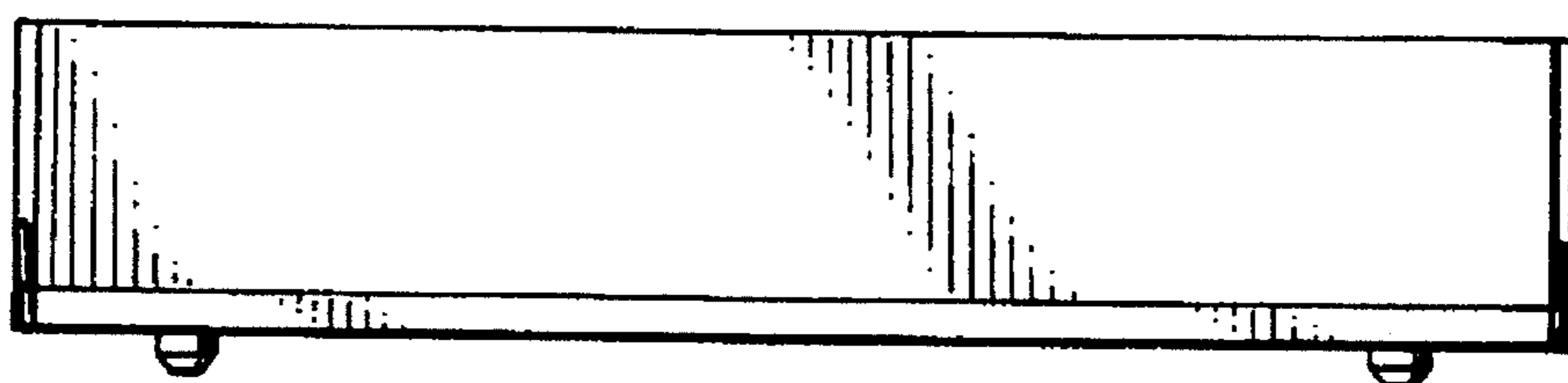

FIG. 4

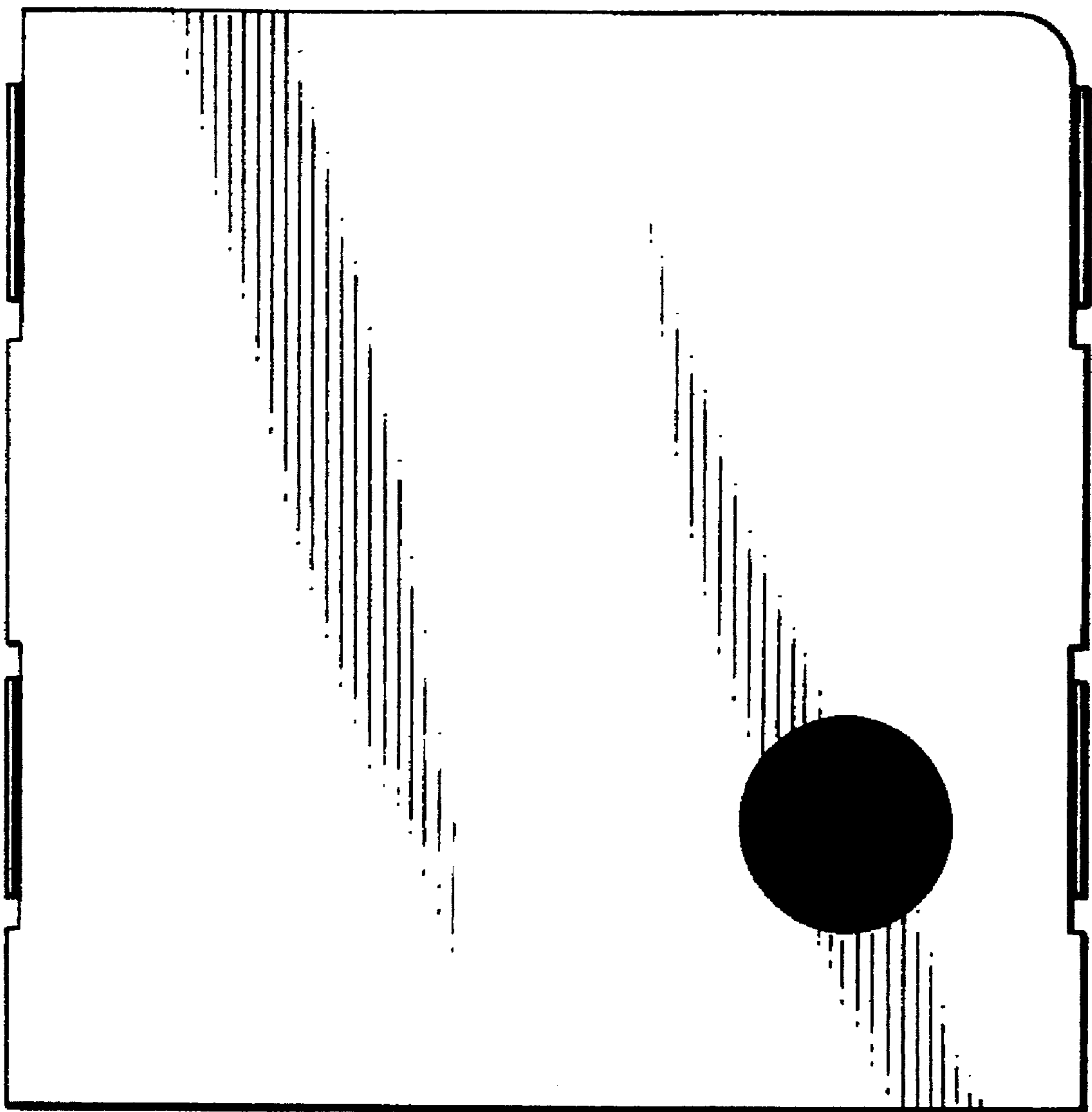

FIG. 5

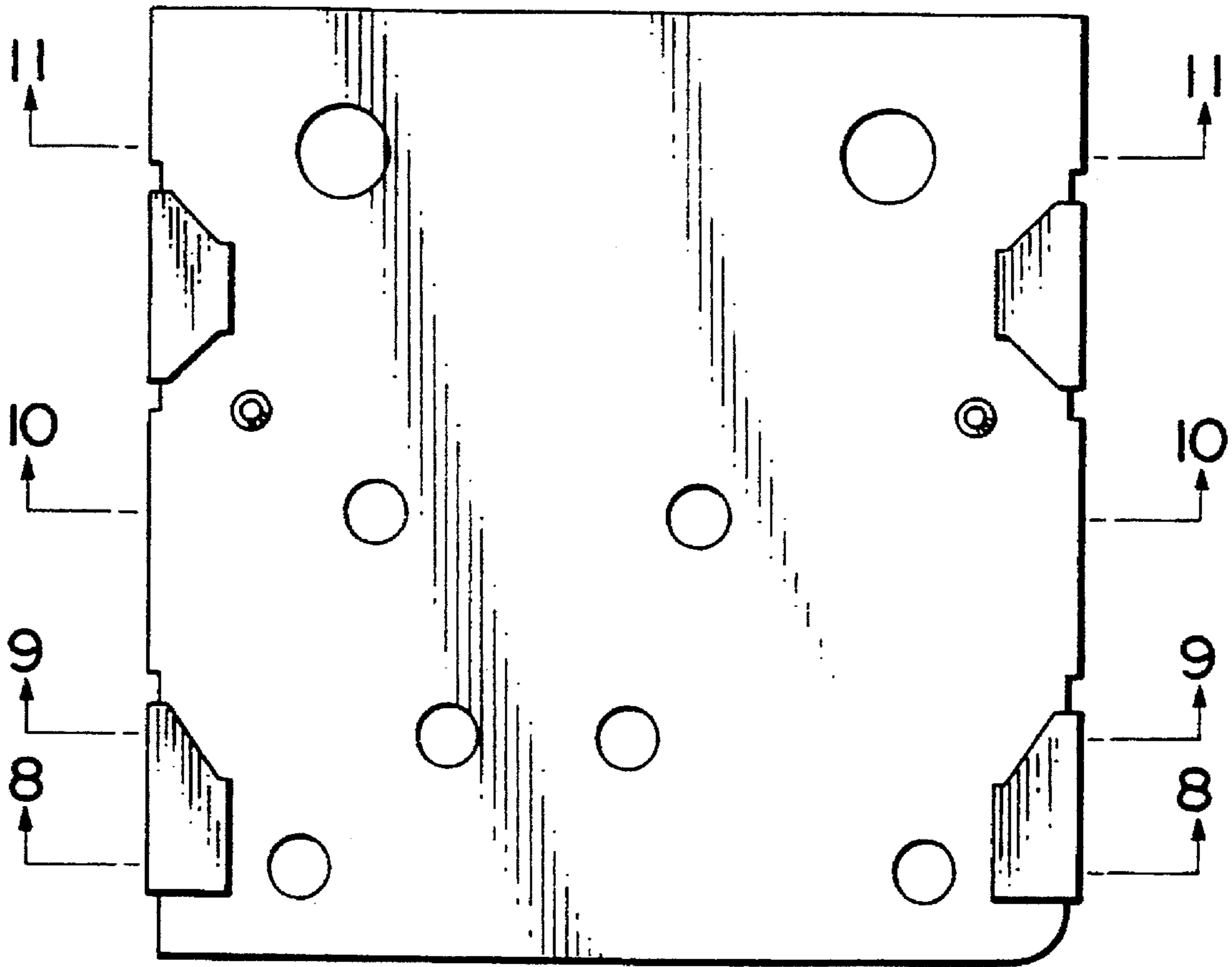

FIG. 6

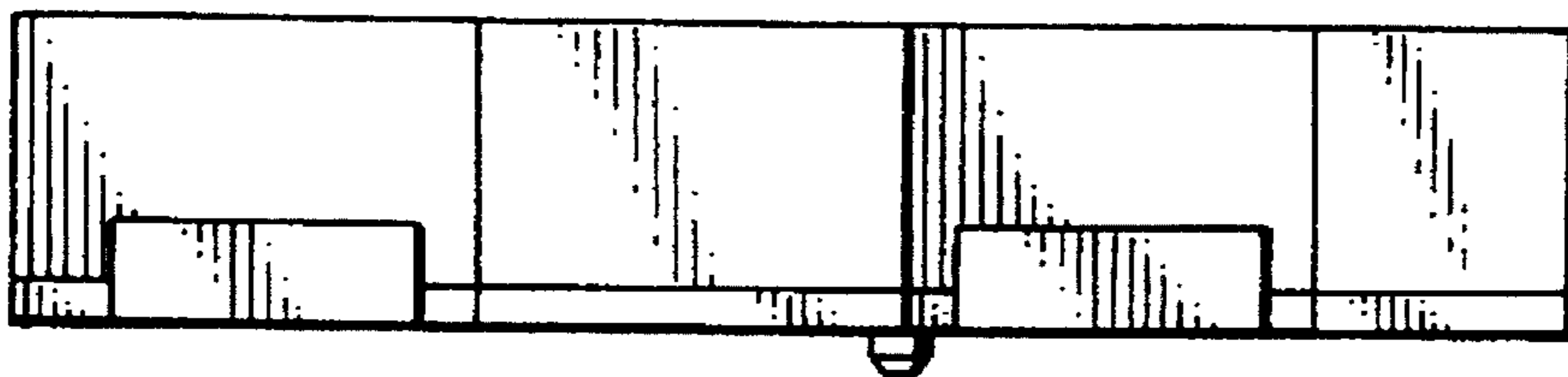

FIG. 7

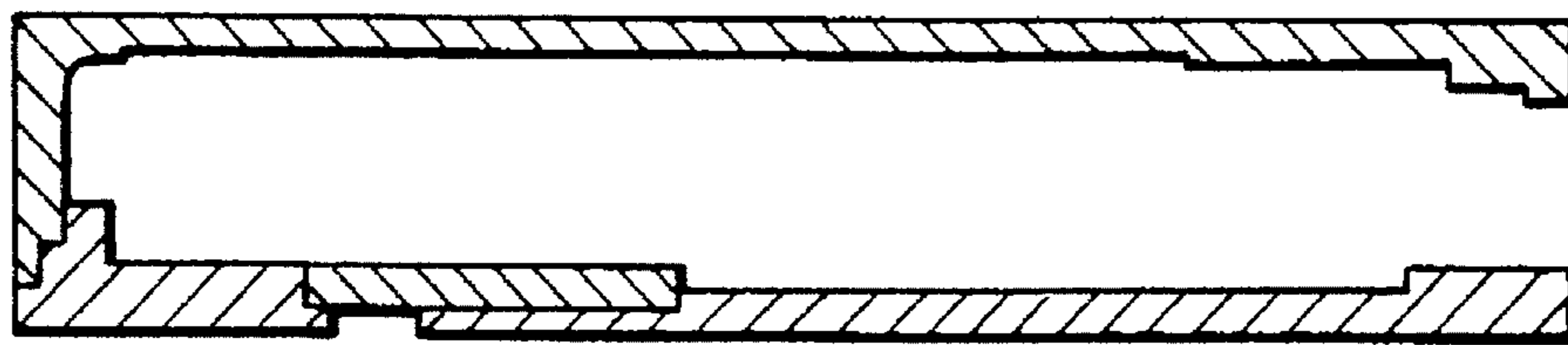

FIG. 8

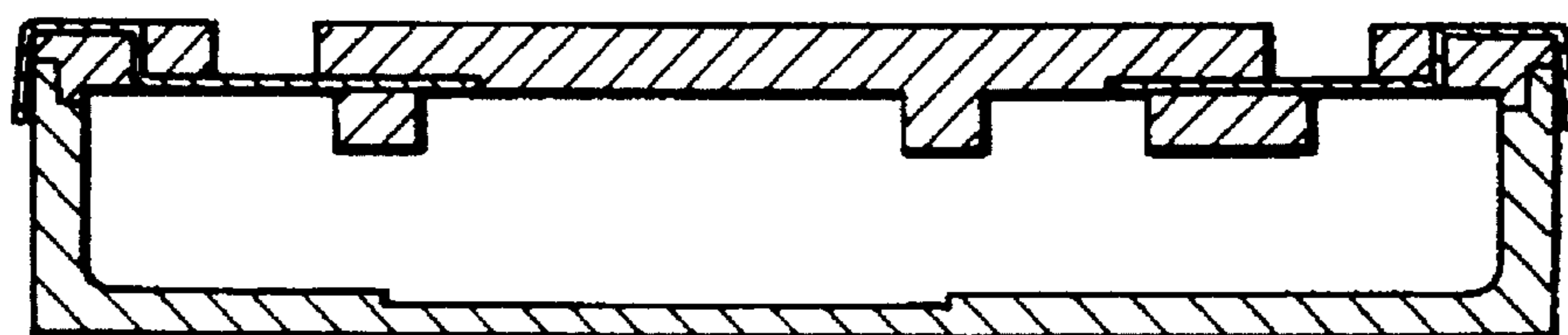

FIG. 9

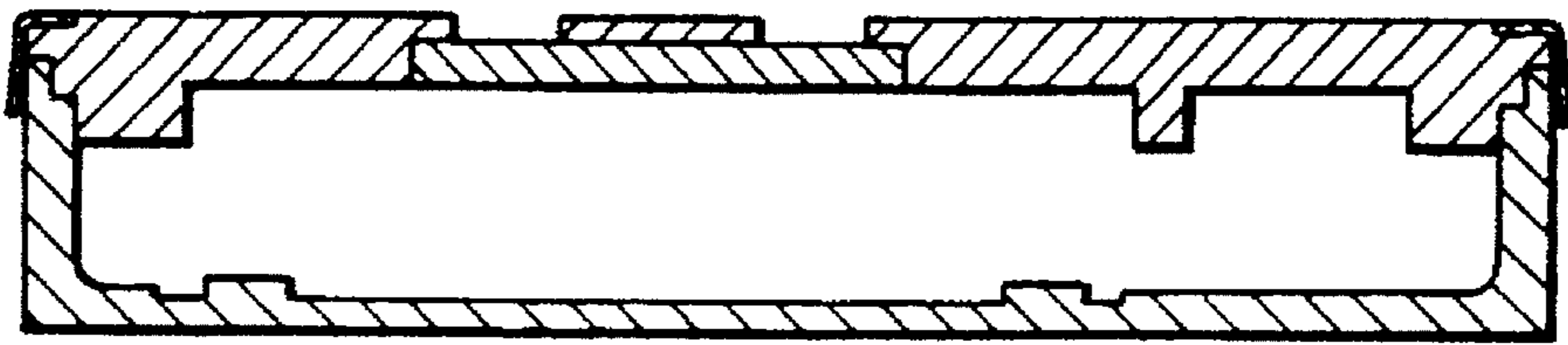

FIG. 10

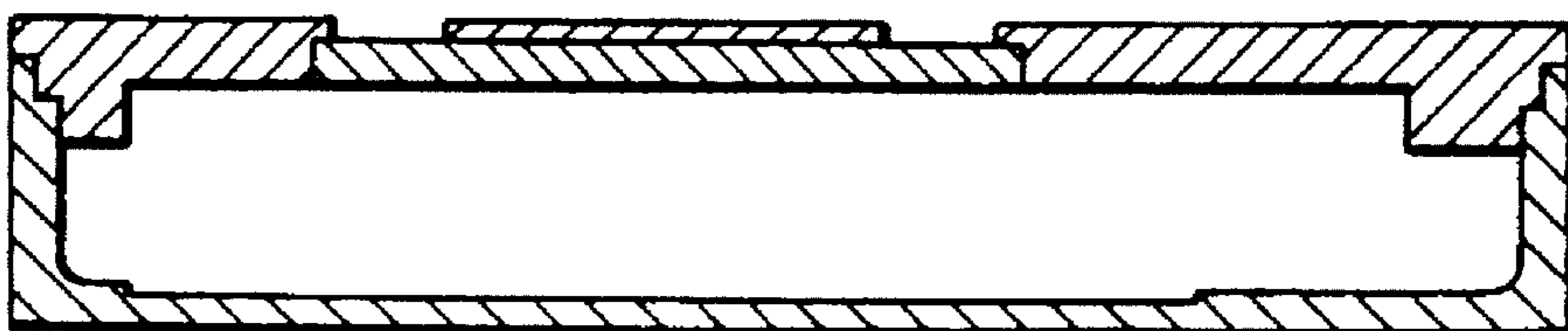

FIG. II

