



US00D371271S

United States Patent [19]

Seiffert et al.

[11] Patent Number: **Des. 371,271**

[45] Date of Patent: ****Jul. 2, 1996**

- [54] **ELECTRIC COFFEEMAKER**
- [75] Inventors: **Florian Seiffert, Wiesbaden; Hartwig Kahlcke, Kronberg, both of Germany**
- [73] Assignee: **Robert Krups GmbH & Co. KG, Solingen, Germany**
- [**] Term: **14 Years**
- [21] Appl. No.: **39,806**
- [22] Filed: **May 26, 1995**
- [30] **Foreign Application Priority Data**

Nov. 29, 1994 [FR] France 0946481
 [52] U.S. Cl. **D7/309; D7/310; D7/311**
 [58] Field of Search D7/309, 310, 311,
 D7/300, 318; 99/293, 279

[56] References Cited

U.S. PATENT DOCUMENTS

- D. 288,517 3/1987 Kahlcke D7/309
- D. 313,145 12/1990 Maass et al. D7/309
- D. 313,146 12/1990 Precht D7/310 X
- D. 342,413 12/1993 Ullmann D7/309

- D. 342,639 12/1993 Ullmann D7/309
- D. 343,758 2/1994 Begren D7/311 X
- D. 345,881 4/1994 Maass D7/310 X
- D. 355,561 2/1995 Ullmann D7/310 X
- D. 359,413 6/1995 Storsberg D7/309
- D. 360,333 7/1995 Wai D7/309

Primary Examiner—M. N. Pandozzi
Attorney, Agent, or Firm—Young & Thompson

[57] CLAIM

The ornamental design for an electric coffeemaker, as shown.

DESCRIPTION

FIG. 1 is a top, front and side perspective view of an electric coffeemaker showing our new design;
 FIG. 2 is a front elevational view thereof;
 FIG. 3 is a side elevational view thereof from the left of FIG. 2;
 FIG. 4 is a side elevational view thereof from the right of FIG. 2;
 FIG. 5 is a rear elevational view thereof;
 FIG. 6 is a top plan view thereof; and,
 FIG. 7 is a bottom plan view thereof.

1 Claim, 7 Drawing Sheets

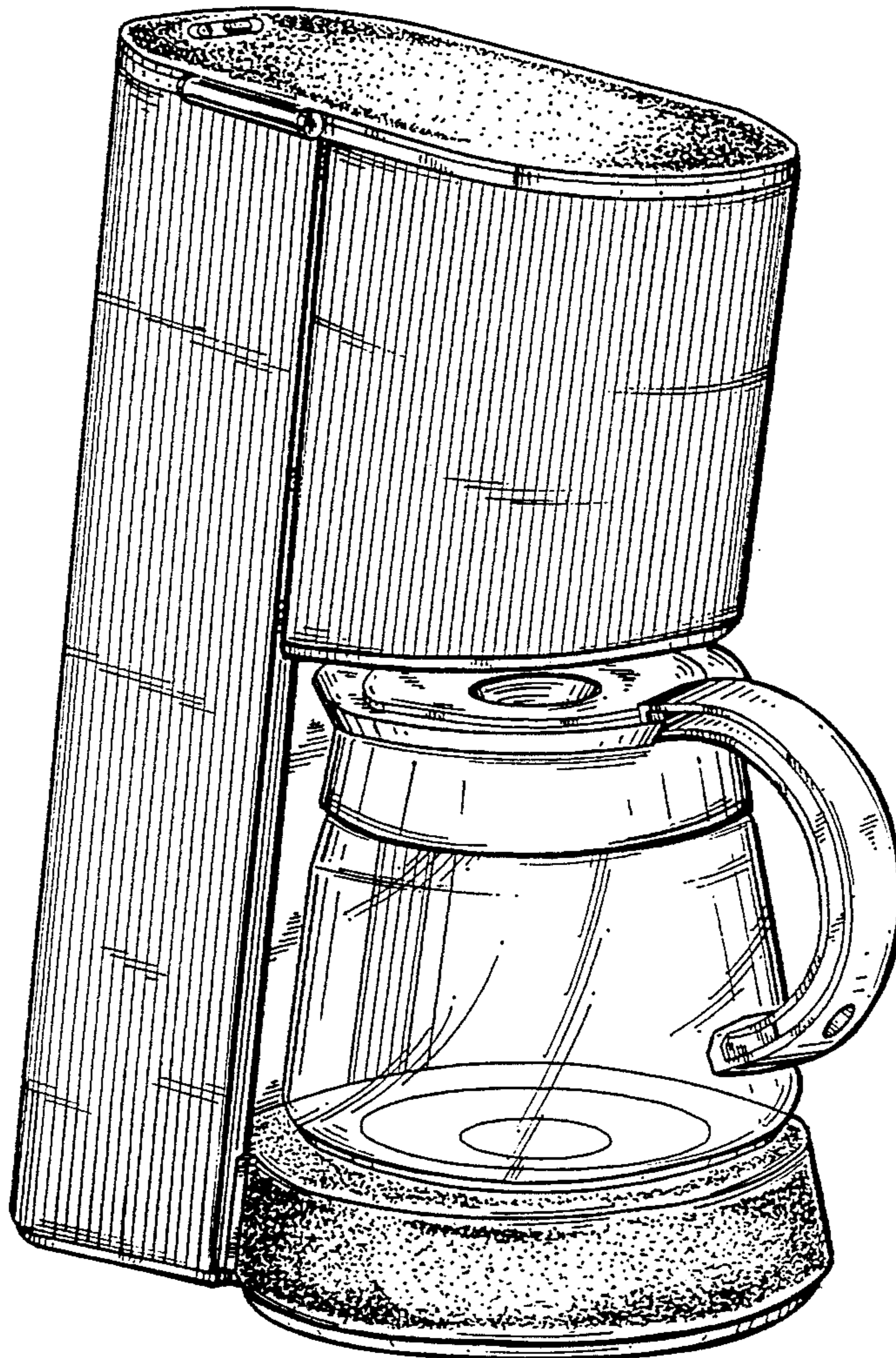

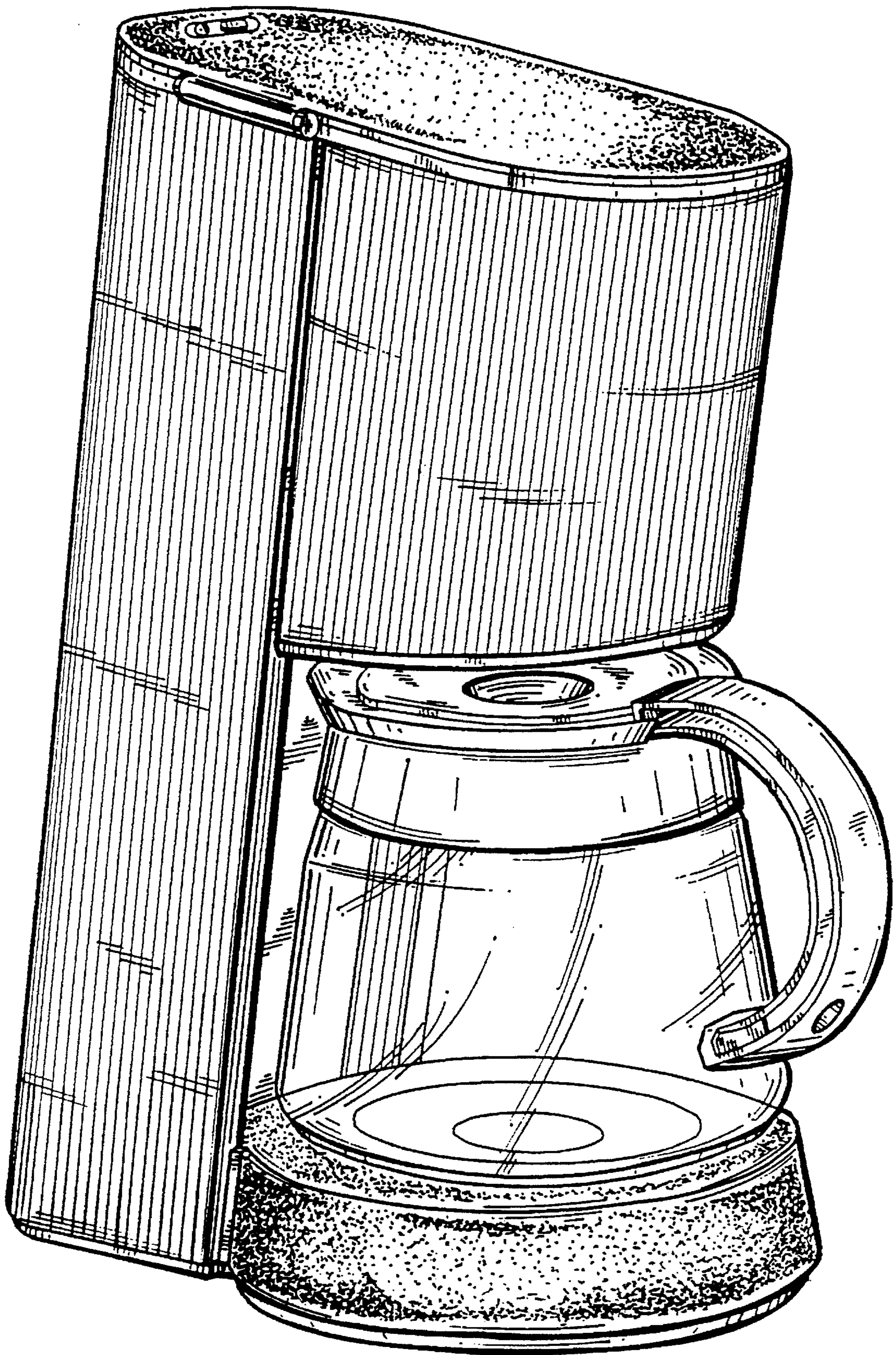

FIG. 1

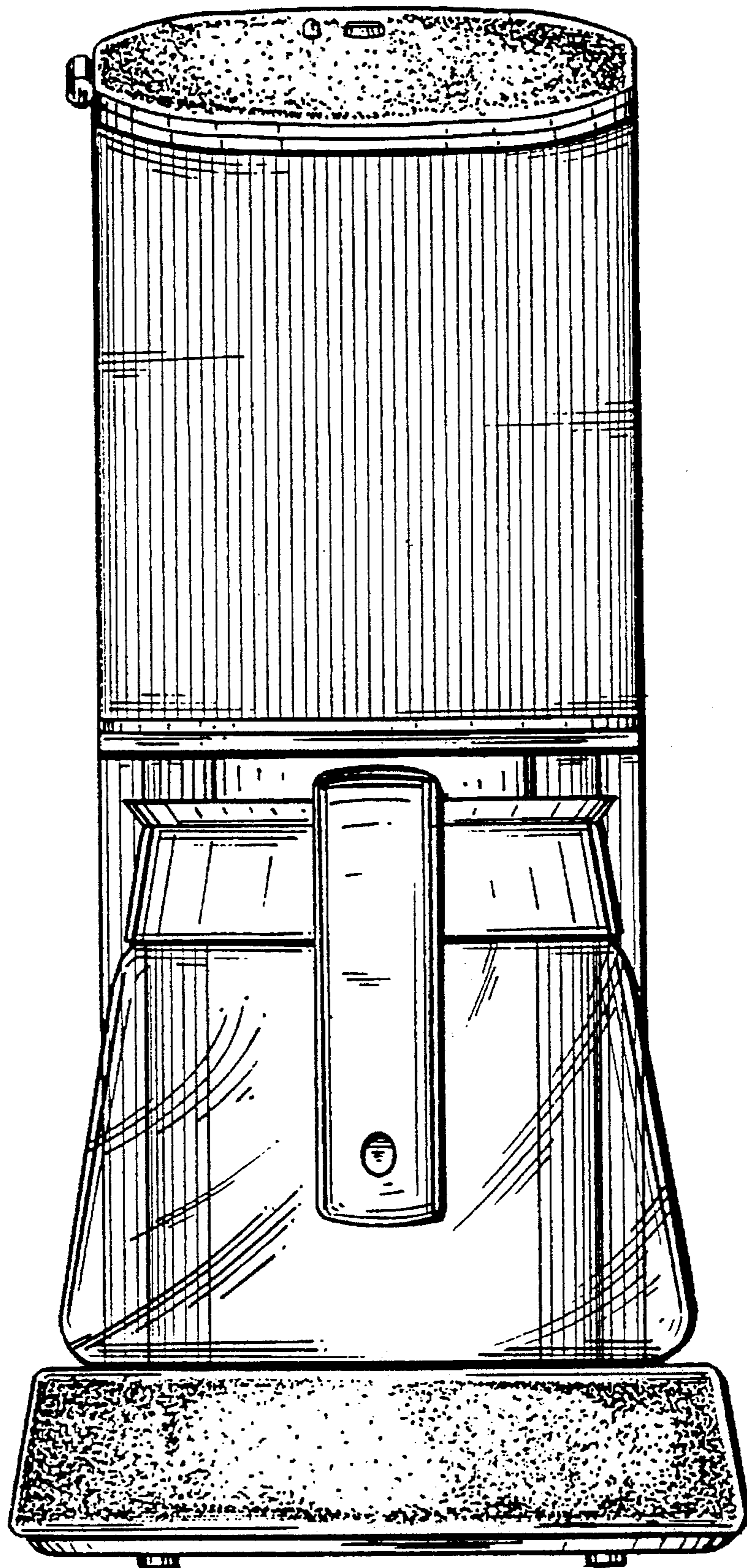

FIG. 2

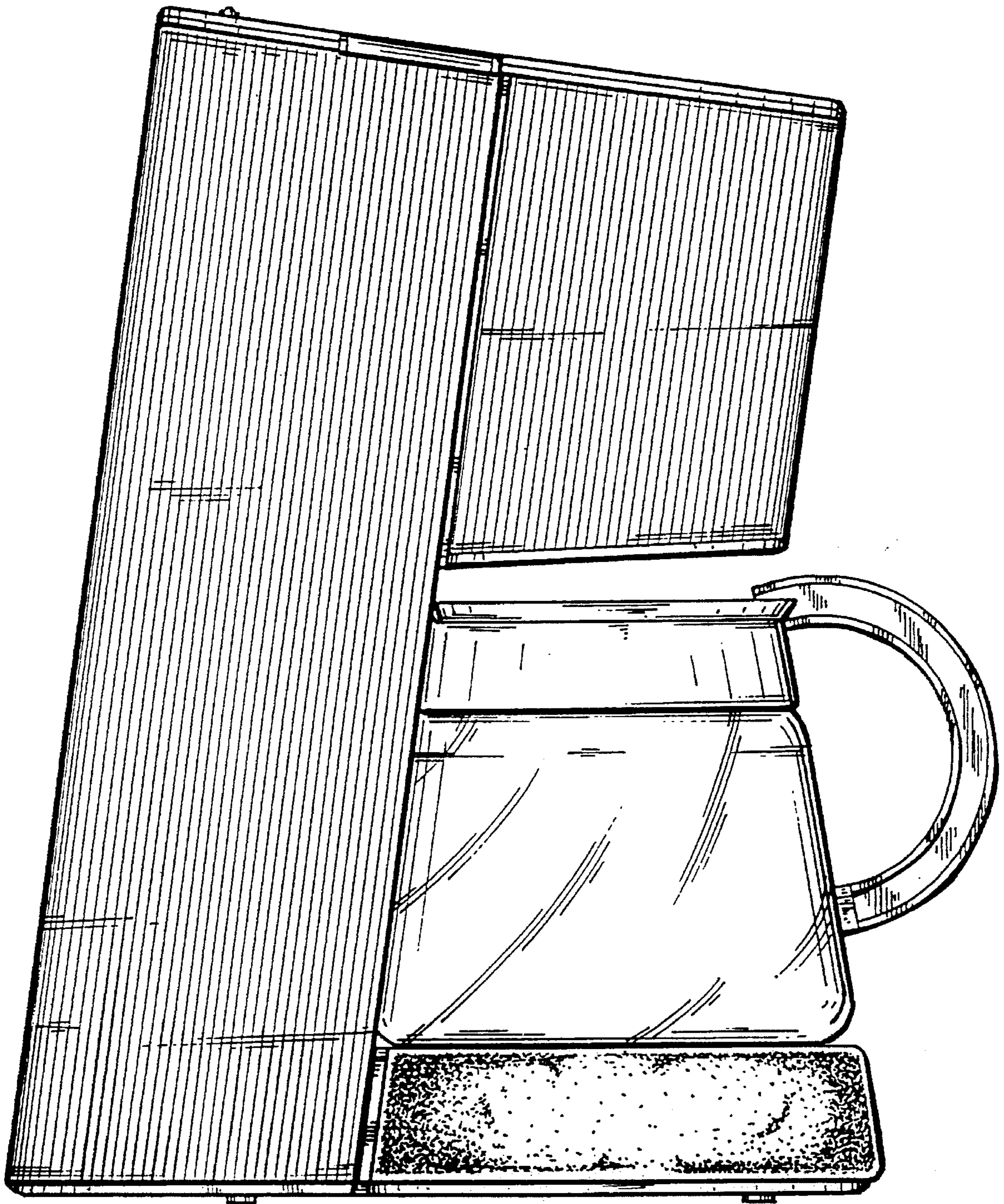

FIG. 3

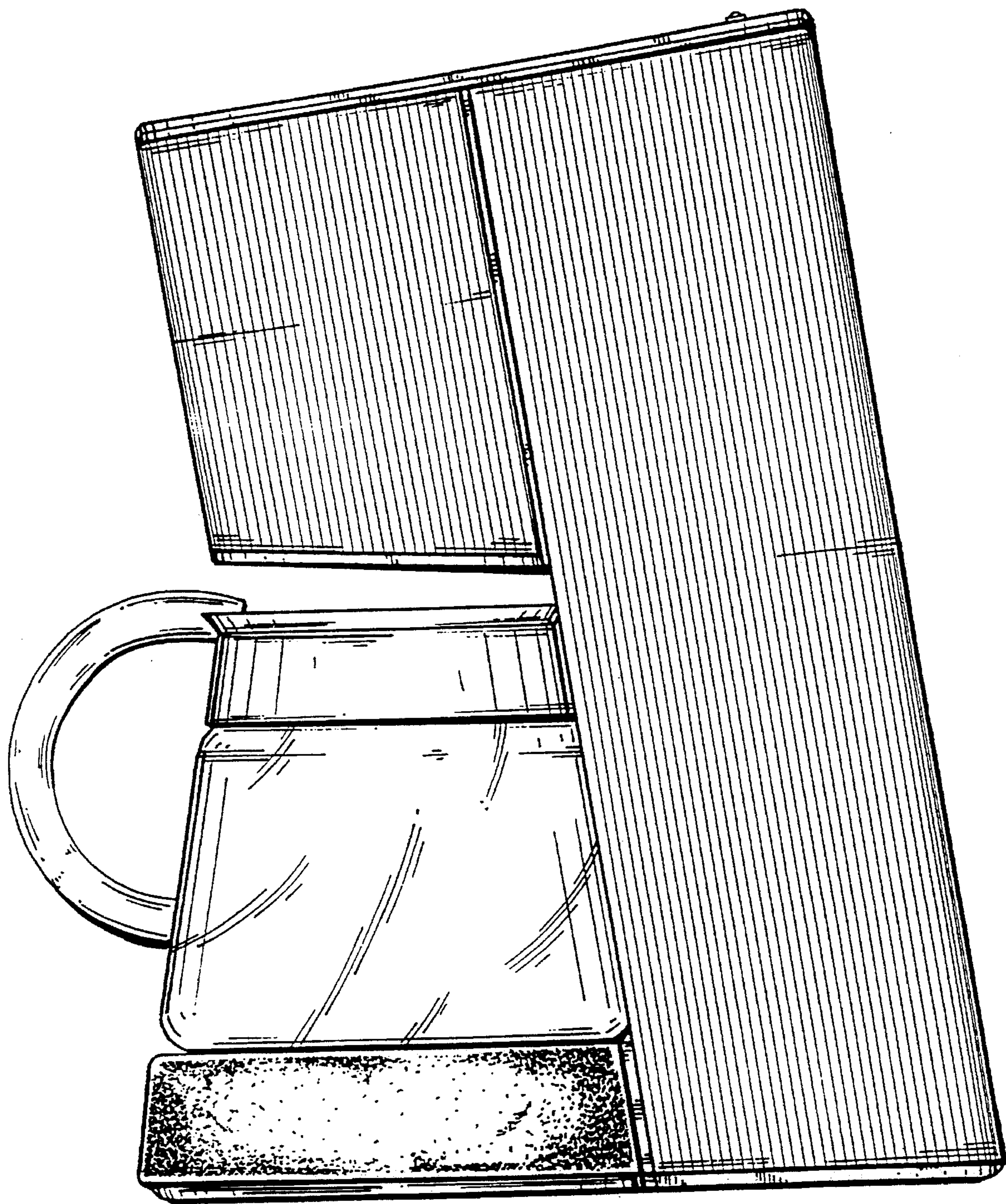

FIG. 4

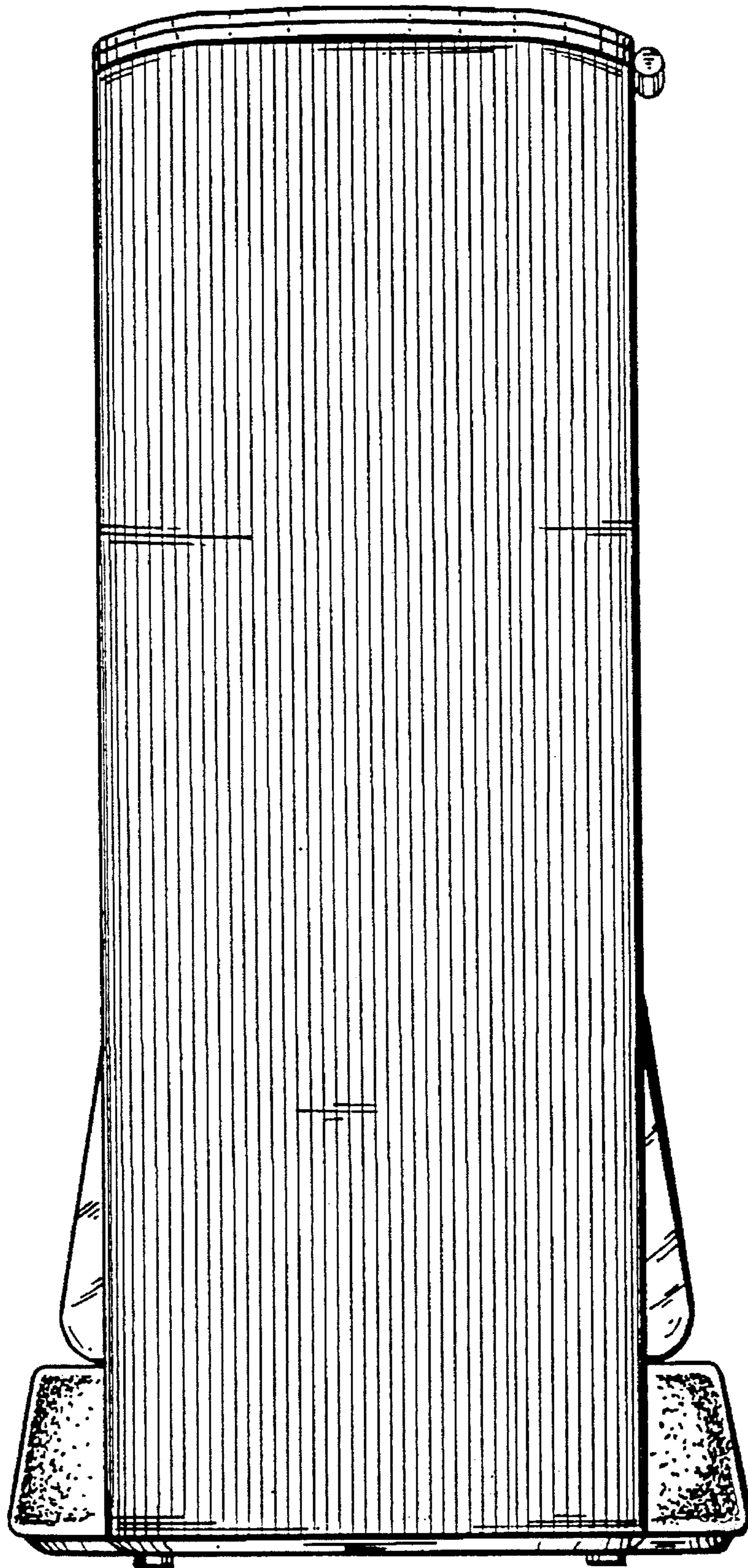

FIG. 5

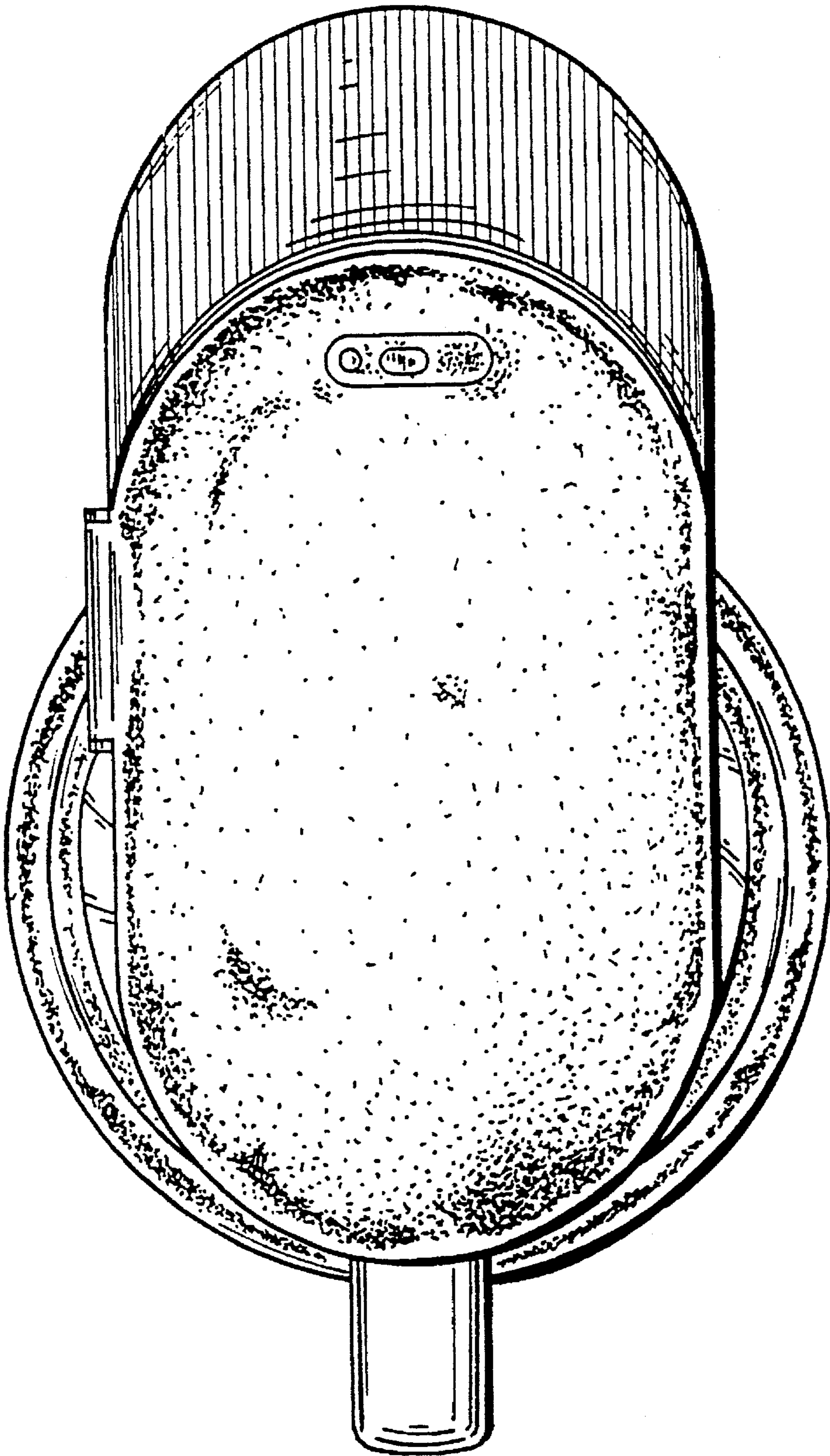

FIG. 6

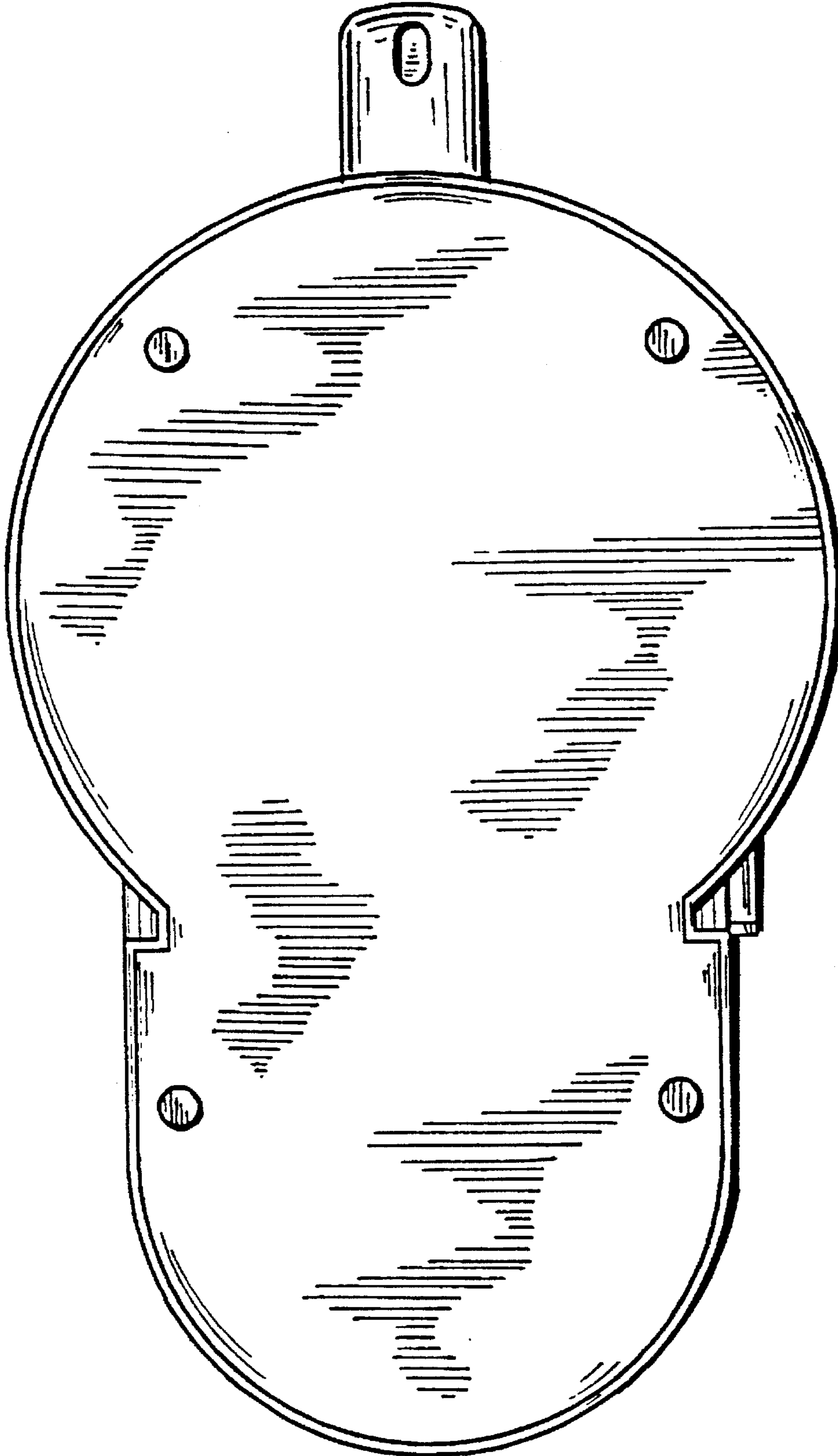

FIG. 7