



US00D371141S

United States Patent [19]

[11] Patent Number: **Des. 371,141**

Bonzer

[45] Date of Patent: ****Jun. 25, 1996**

[54] **ELECTRIC AIR PUMP IN ATHLETIC SHOE HOUSING**

[75] Inventor: **Robert L. Bonzer**, Boise, Id.

[73] Assignee: **Bon-Aire Industries, Inc.**, Boise, Id.

[**] Term: **14 Years**

[21] Appl. No.: **36,063**

[22] Filed: **Mar. 13, 1995**

[52] U.S. Cl. **D15/7**

[58] Field of Search D15/7-9.2; D24/8; D26/38; 417/415, 235

[56] **References Cited**

U.S. PATENT DOCUMENTS

- D. 340,458 10/1993 Wang D15/7
- D. 356,800 3/1995 Chen D15/7
- D. 358,397 5/1995 Phillips et al. D15/7

Primary Examiner—Ralf Seifert
Attorney, Agent, or Firm—Stoel Rives

[57] **CLAIM**

The ornamental design for an electric air pump in athletic shoe housing, as shown and described.

DESCRIPTION

FIG. 1 is a top, right front perspective view of an electric air pump in an athletic shoe housing according to my new design, including an electric power cord and an air pump hose shown in stowed positions;

FIG. 2 is a top right front perspective view of the electric air pump in an athletic shoe housing of FIG. 1, showing the electric power cord and air hose not in their stowed positions;

FIG. 3 is a right side elevational view of the electric air pump in an athletic shoe housing of FIG. 1, including the electric power cord and the air pump hose shown in stowed positions;

FIG. 4 is a left side elevational view thereof;

FIG. 5 is a top plan view thereof;

FIG. 6 is a bottom plan view thereof;

FIG. 7 is a front elevational view thereof; and,

FIG. 8 is a rear elevational view thereof.

1 Claim, 3 Drawing Sheets

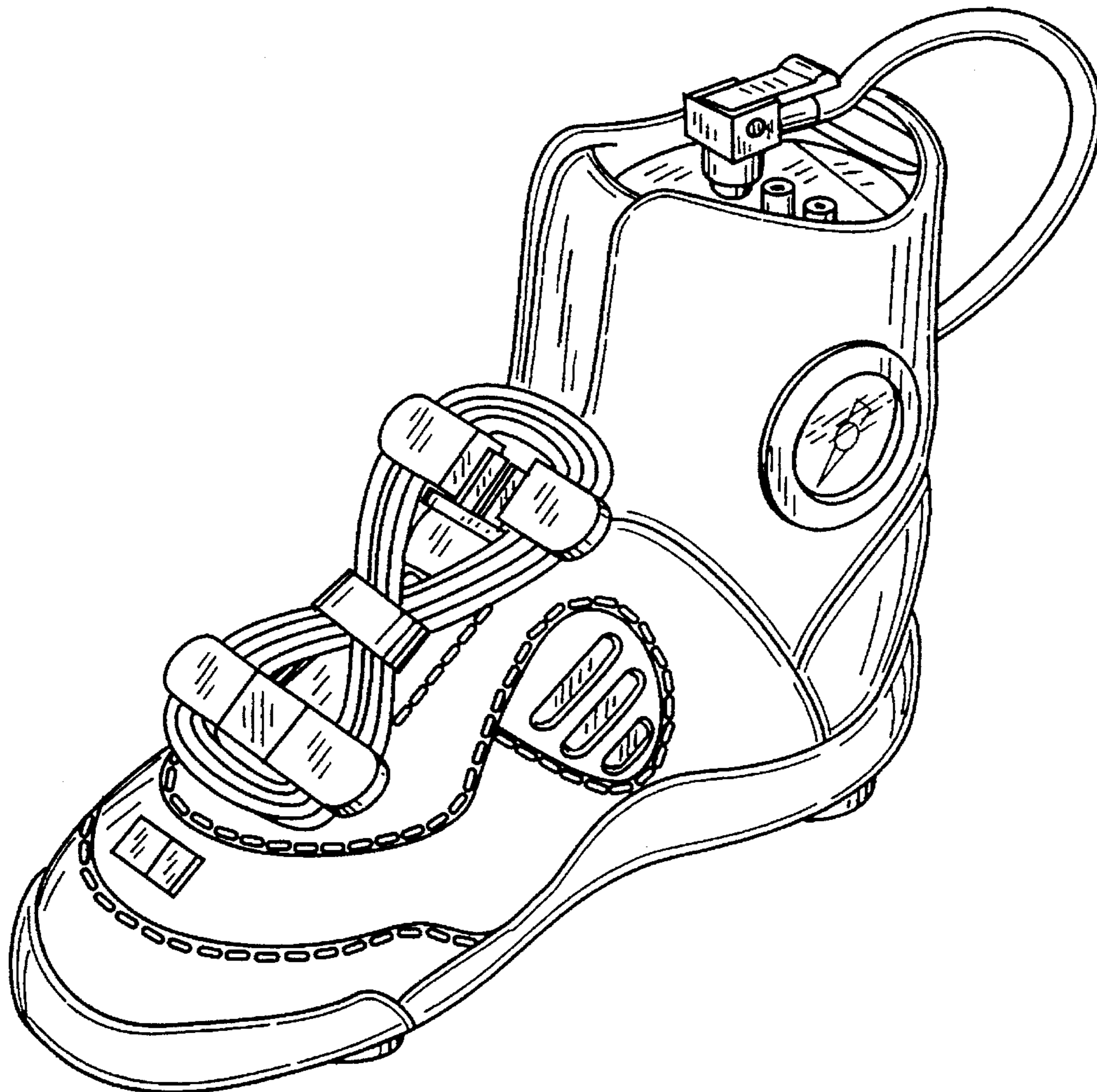

FIG. 1

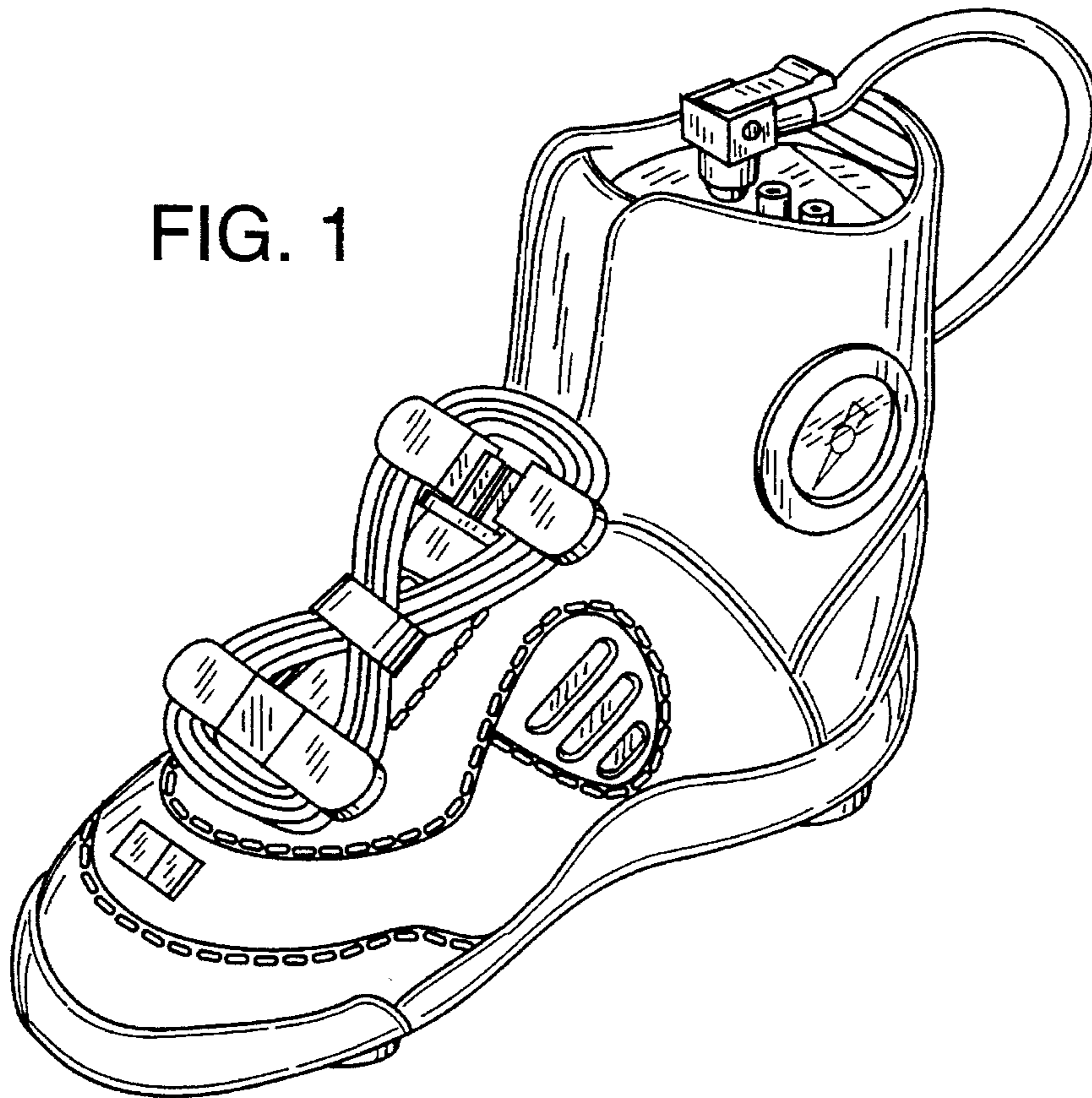

FIG. 2

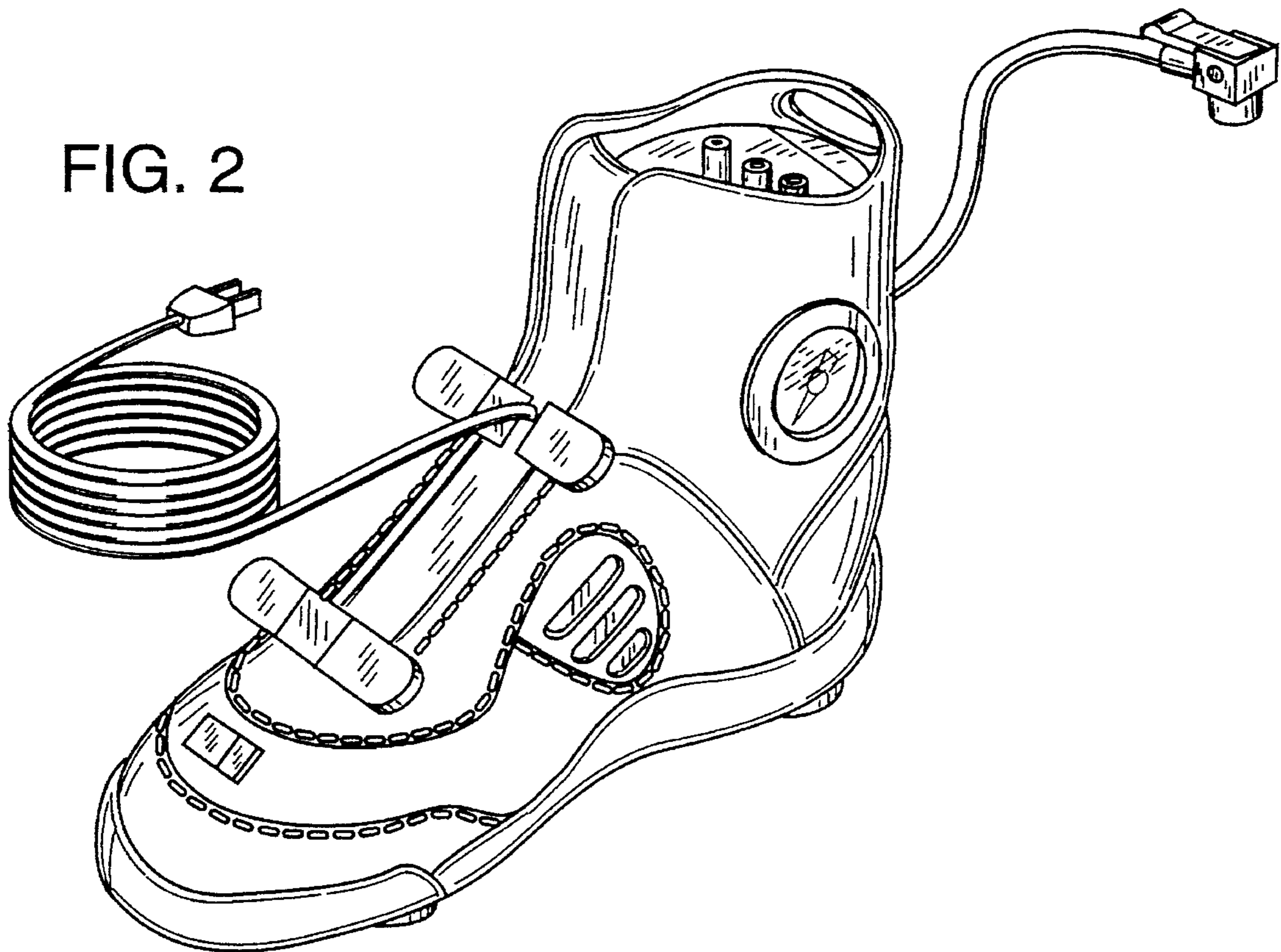

FIG. 3

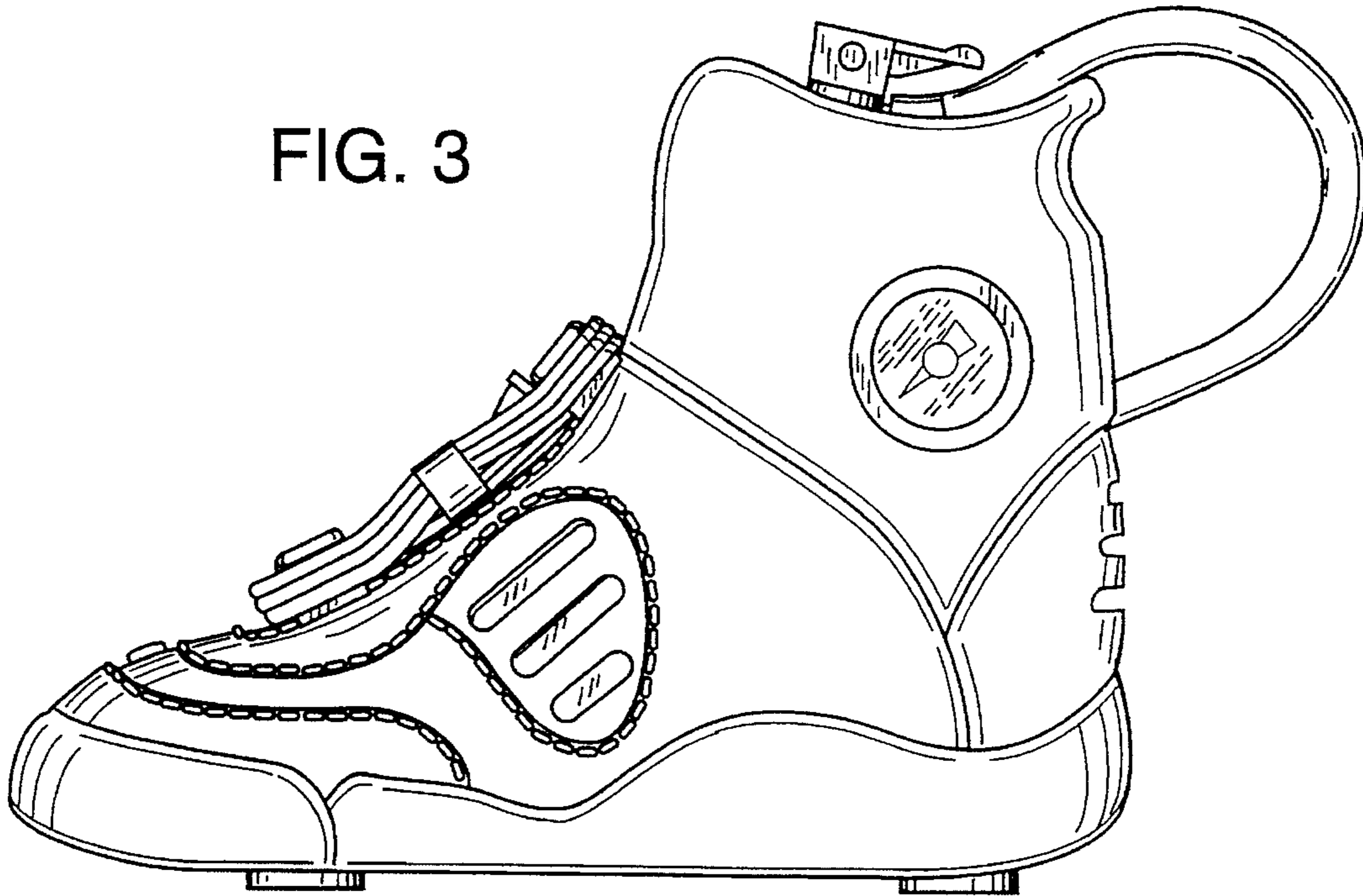

FIG. 4

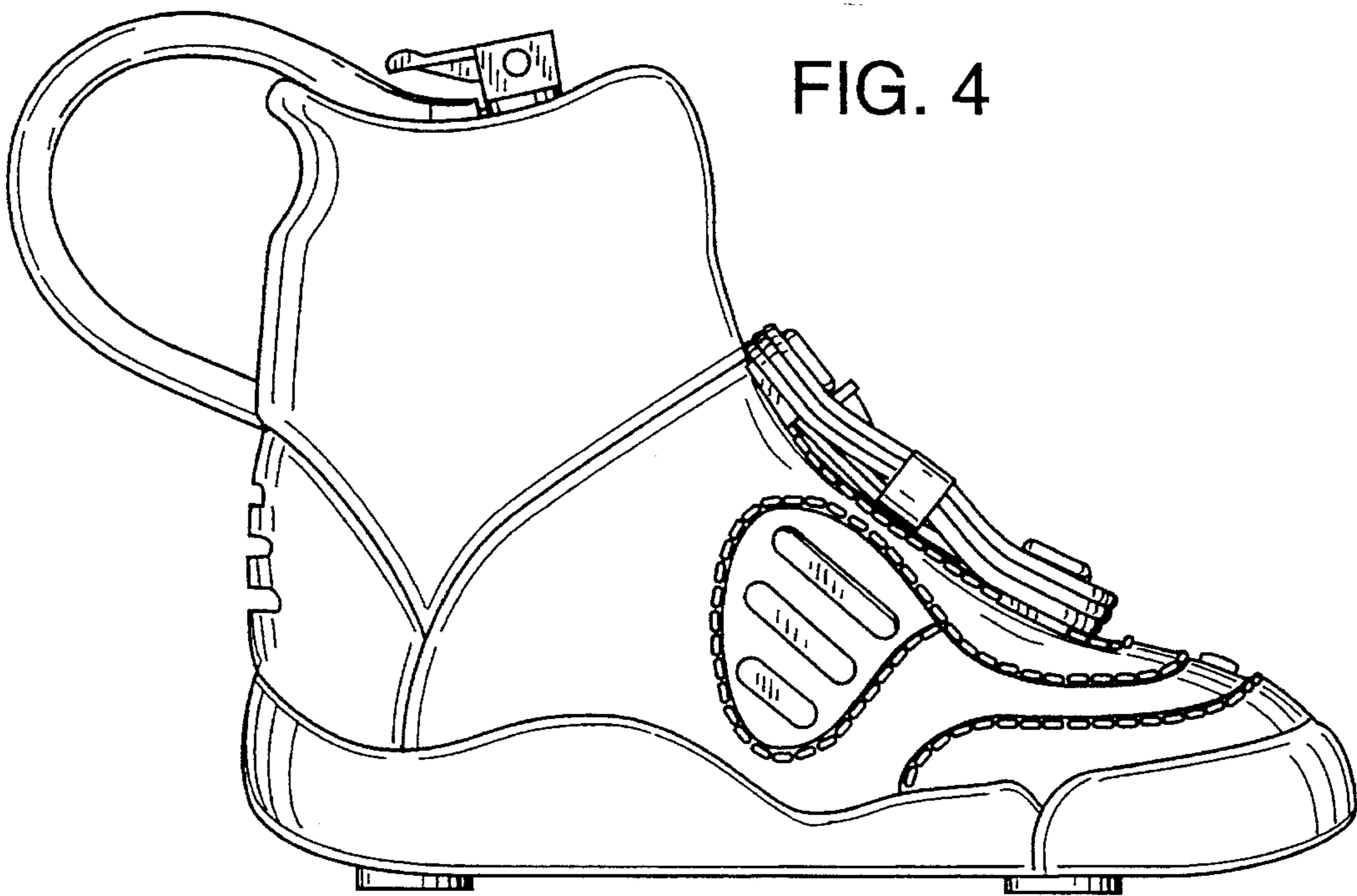

FIG. 5

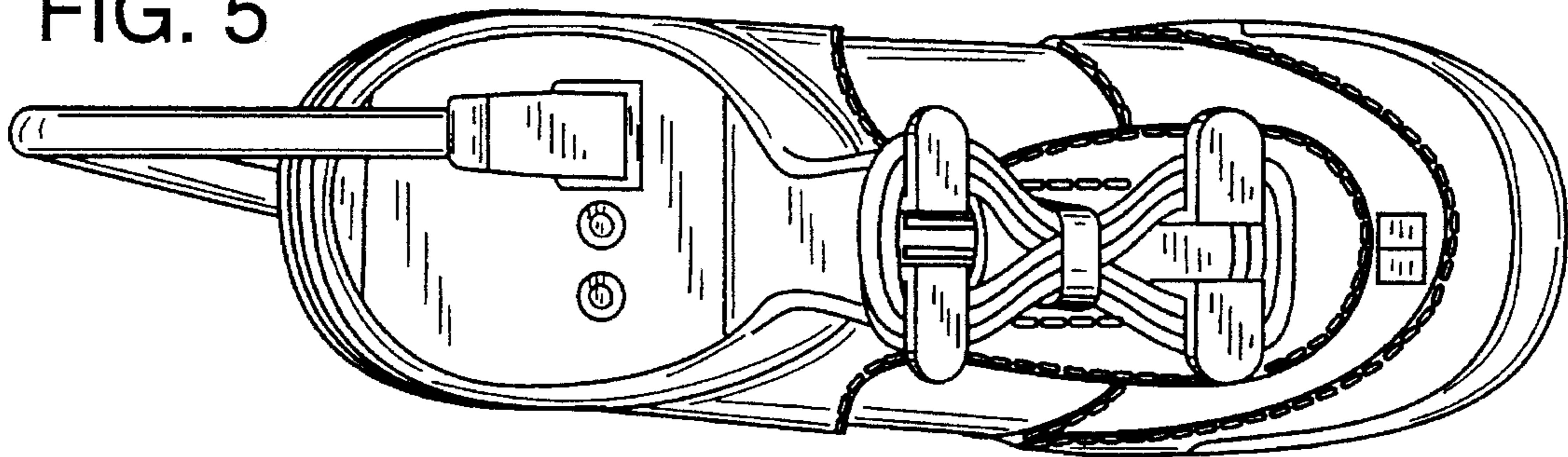

FIG. 6

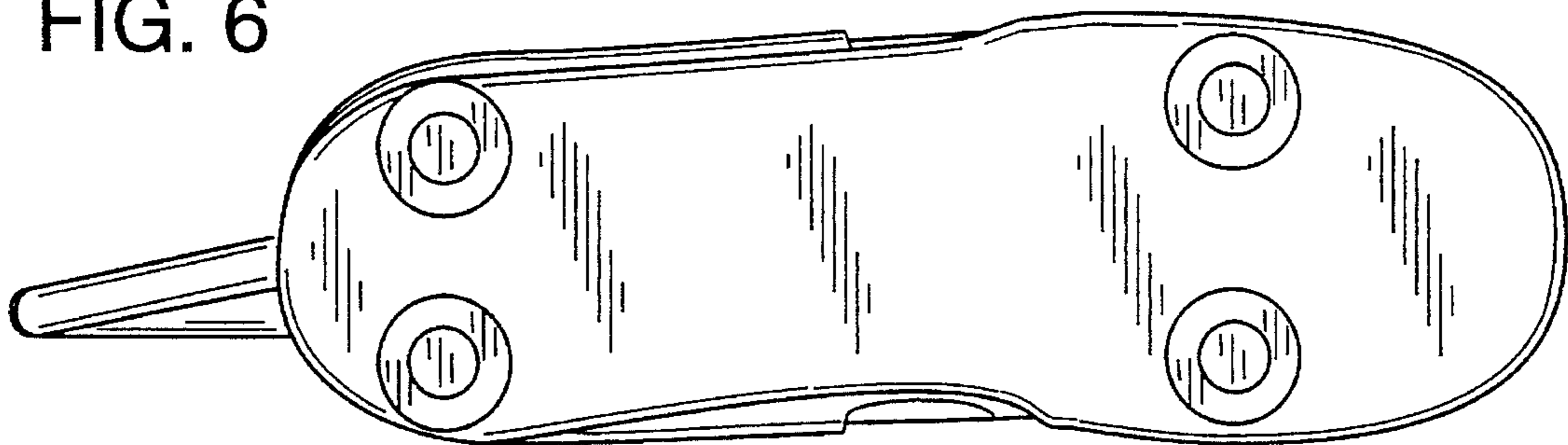

FIG. 7

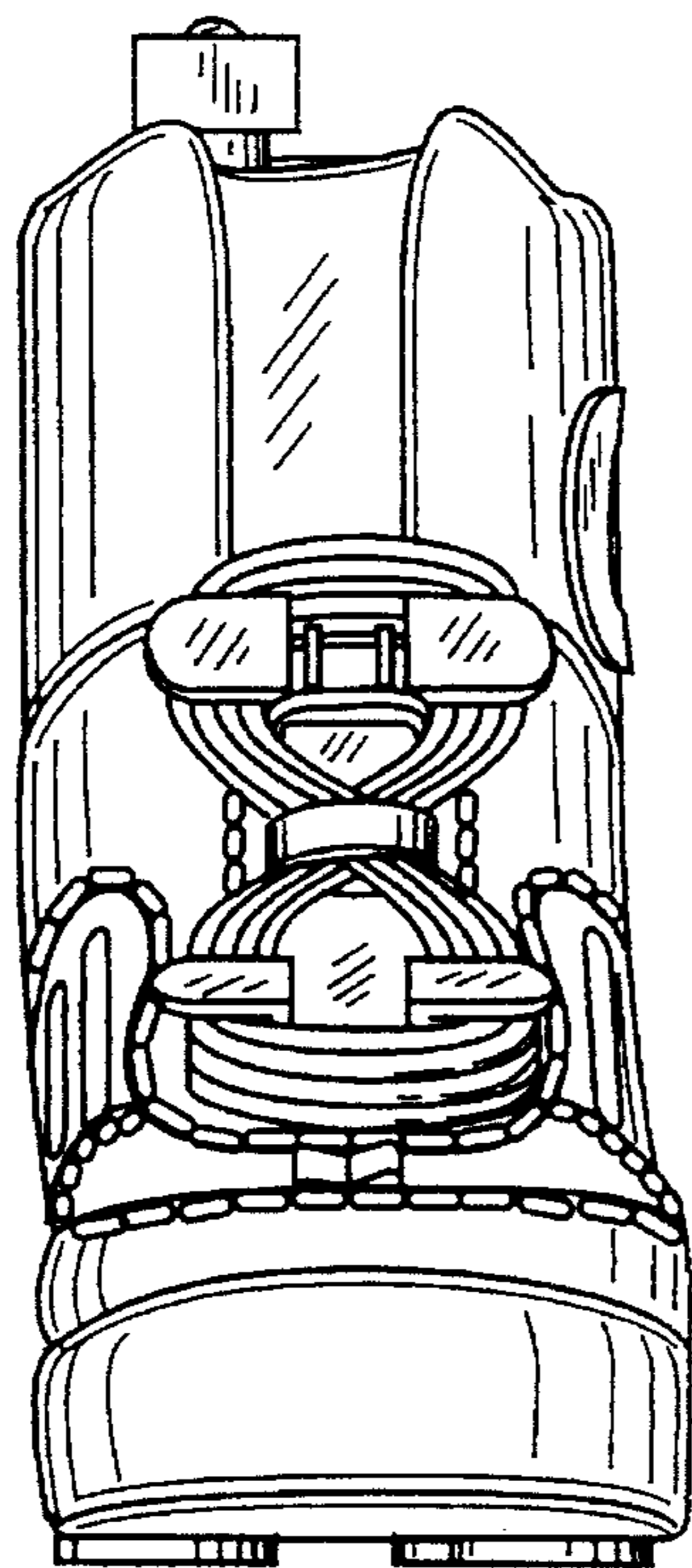

FIG. 8

