



US00D371023S

United States Patent [19]

[11] Patent Number: **Des. 371,023**

Higgins

[45] Date of Patent: ****Jun. 25, 1996**

[54] **PLASTIC GROCERY BAG HOLDER**

[76] Inventor: **Wesley J. Higgins**, 171 County Rd.
1394, Falkville, Ala. 35622

[**] Term: **14 Years**

4,031,689	6/1977	Sullivan	248/97 X
4,549,748	10/1985	Haley, Sr.	248/99 X
4,893,769	1/1990	Rotelli	248/97
4,896,778	1/1990	Ferdinand et al.	D6/462 X
5,263,672	11/1993	He	248/99 X

OTHER PUBLICATIONS

Tobb Art Designs R108 Bench.
Crown Metal Manufacturing Co., p. 27, E No. 3000 Legs.

Primary Examiner—Jeffrey Asch

[21] Appl. No.: **36,842**

[22] Filed: **Mar. 29, 1995**

[52] U.S. Cl. **D6/462**

[58] Field of Search D6/449, 466, 462-465,
D6/407, 409, 410, 411, 467, 349, 403-405,
429-431; 211/175, 195, 208, 37, 182, 71,
204, 24; 248/95, 97, 99; D12/115; D3/315;
D34/1, 6

[57] **CLAIM**

The ornamental design for a plastic grocery bag holder, as shown and described.

DESCRIPTION

FIG. 1 is a front elevational view of the plastic grocery bag holder showing my new design;
FIG. 2 is a rear elevational view thereof;
FIG. 3 is a left side elevational view thereof;
FIG. 4 is a right side elevational view thereof;
FIG. 5 is a top plan view thereof;
FIG. 6 is bottom plan view thereof; and,
FIG. 7 is an isometric view thereof.

The broken line showing of a plastic grocery bag in FIG. 3 is for illustrative purposes only and form no part of the claimed design.

[56] **References Cited**

U.S. PATENT DOCUMENTS

D. 121,783	8/1940	Castelli et al.	211/37 X
D. 122,462	9/1940	Griffin	D6/464
D. 228,052	8/1973	Howard	D6/462
D. 319,356	8/1991	Vukelich, Sr.	D6/464 X
1,355,033	10/1920	Cheape	211/182 X
1,698,318	1/1929	Norton	D6/467 X
1,927,997	9/1933	Weston	211/71 X
2,051,931	8/1936	Errett et al.	211/71
2,110,158	3/1938	Keeler	D6/411 X
2,940,599	6/1960	Gentner	D6/462 X
3,186,667	6/1965	Meuer	248/97

1 Claim, 4 Drawing Sheets

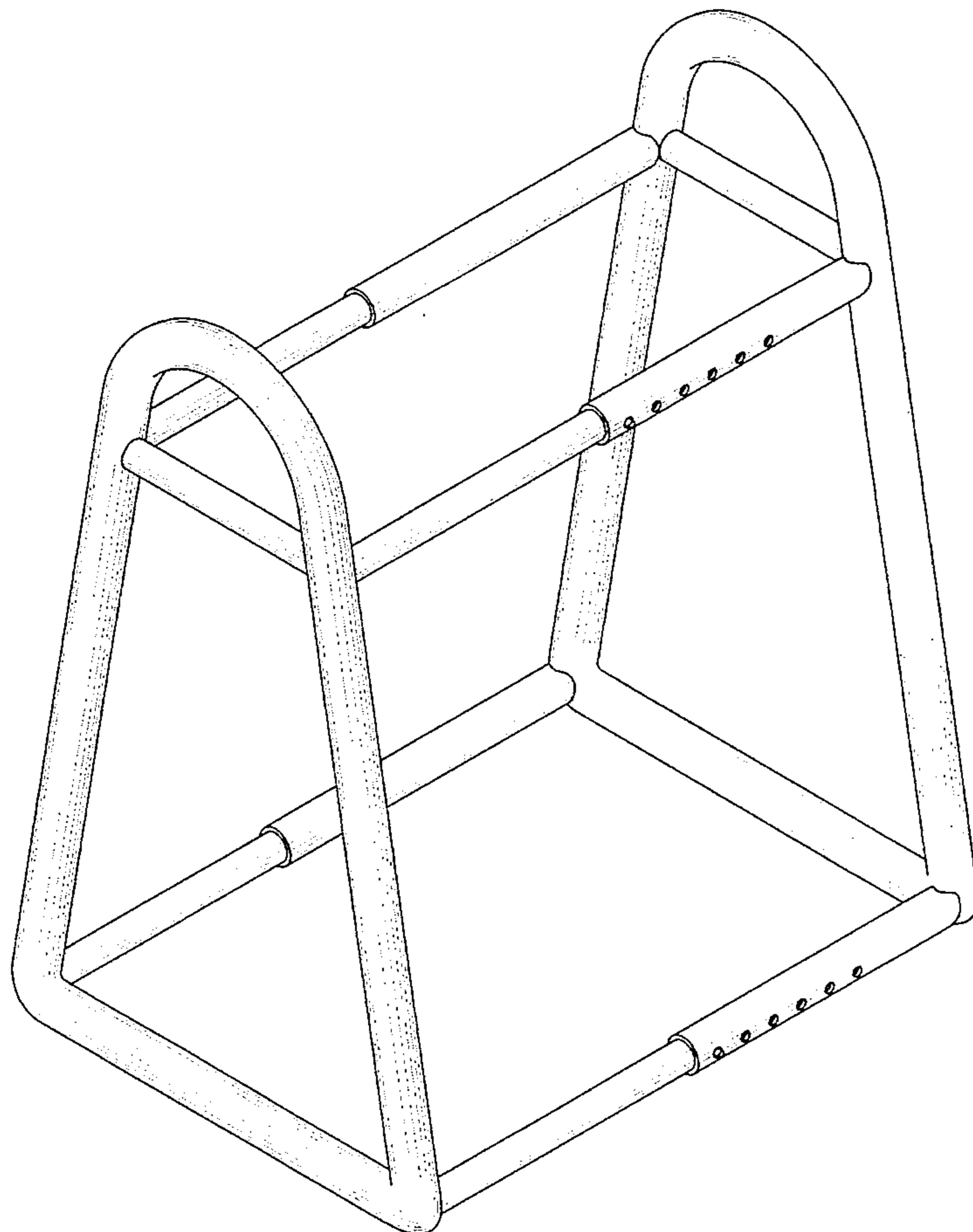

FIG. 1

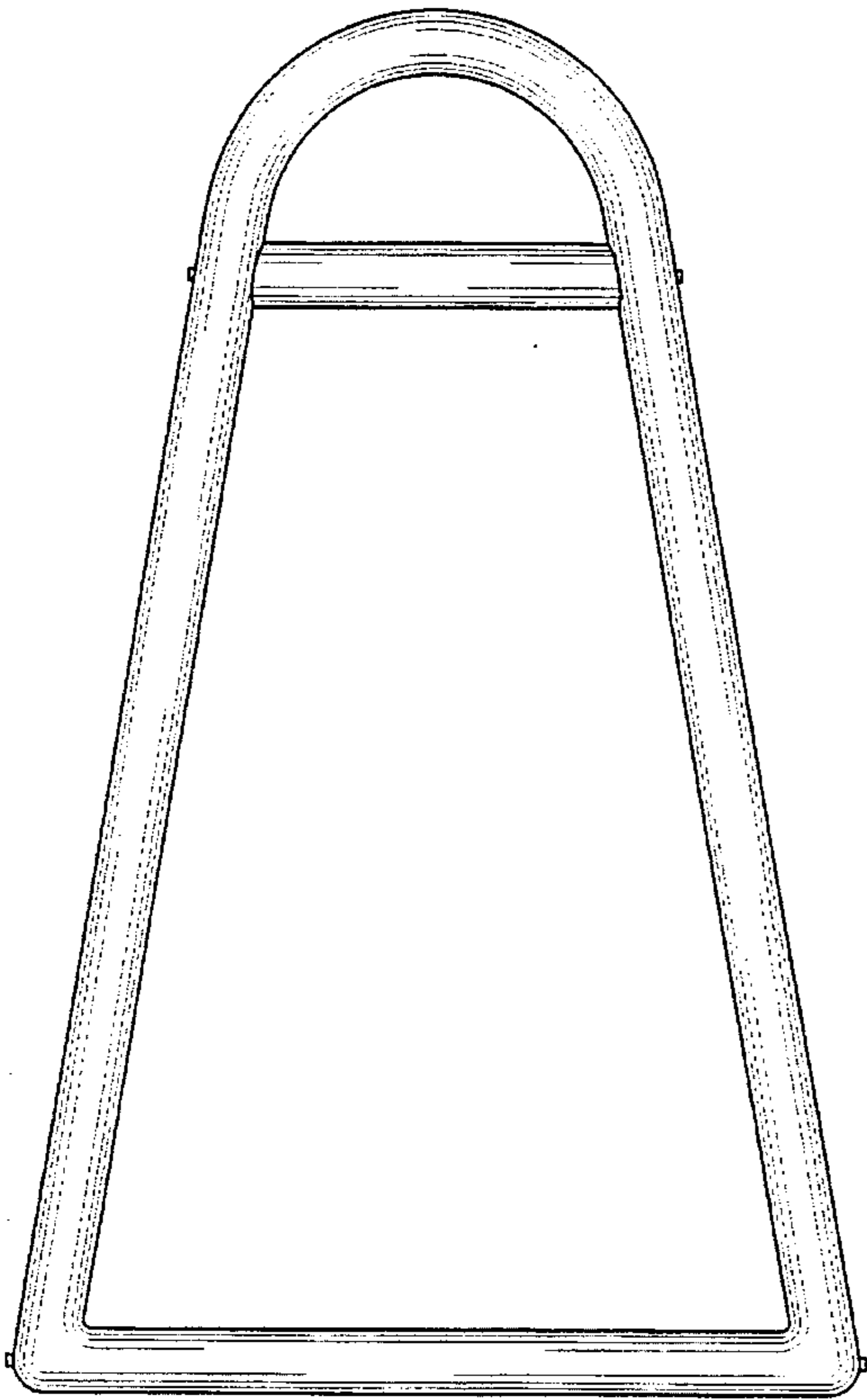

FIG. 2

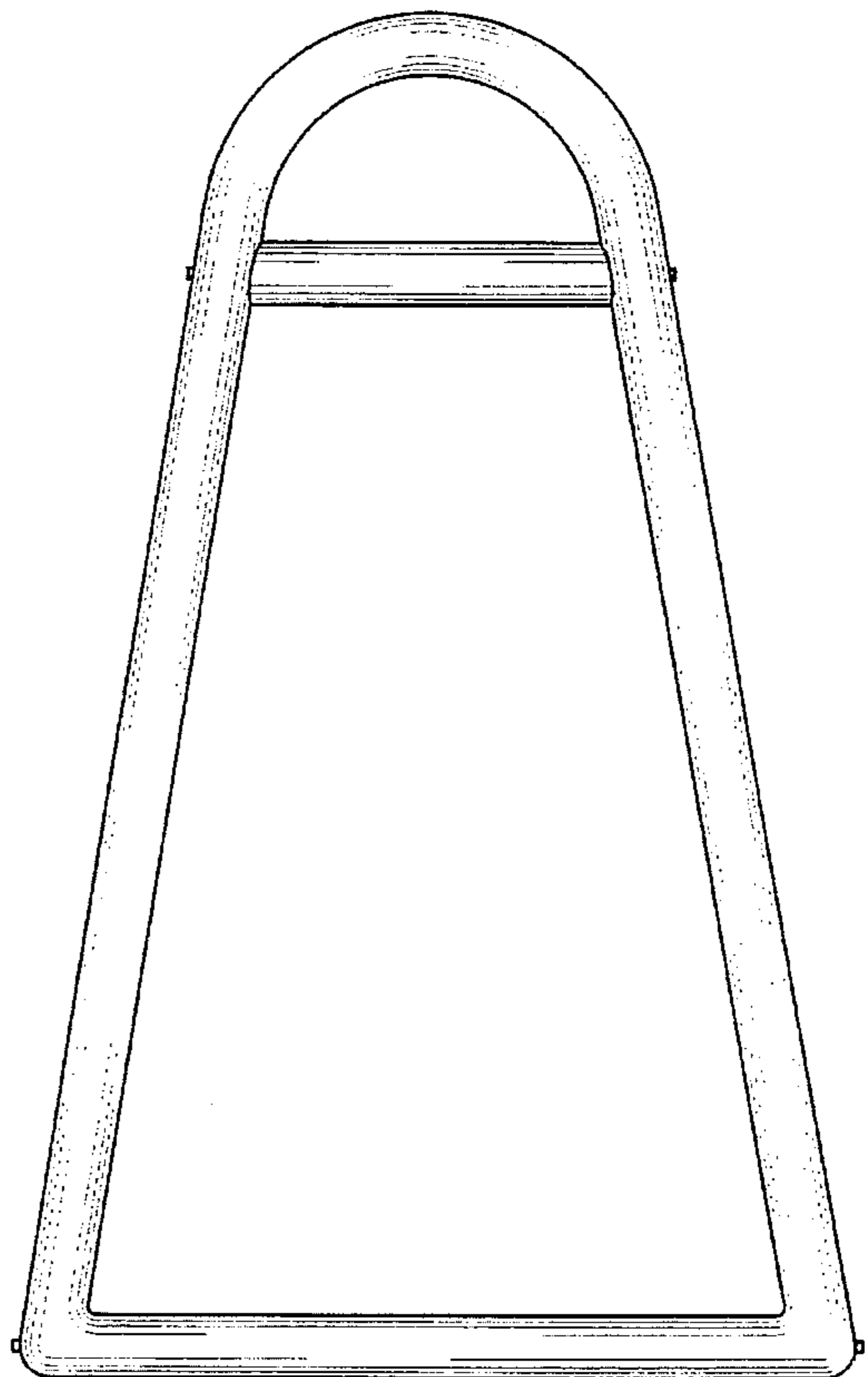

FIG. 3

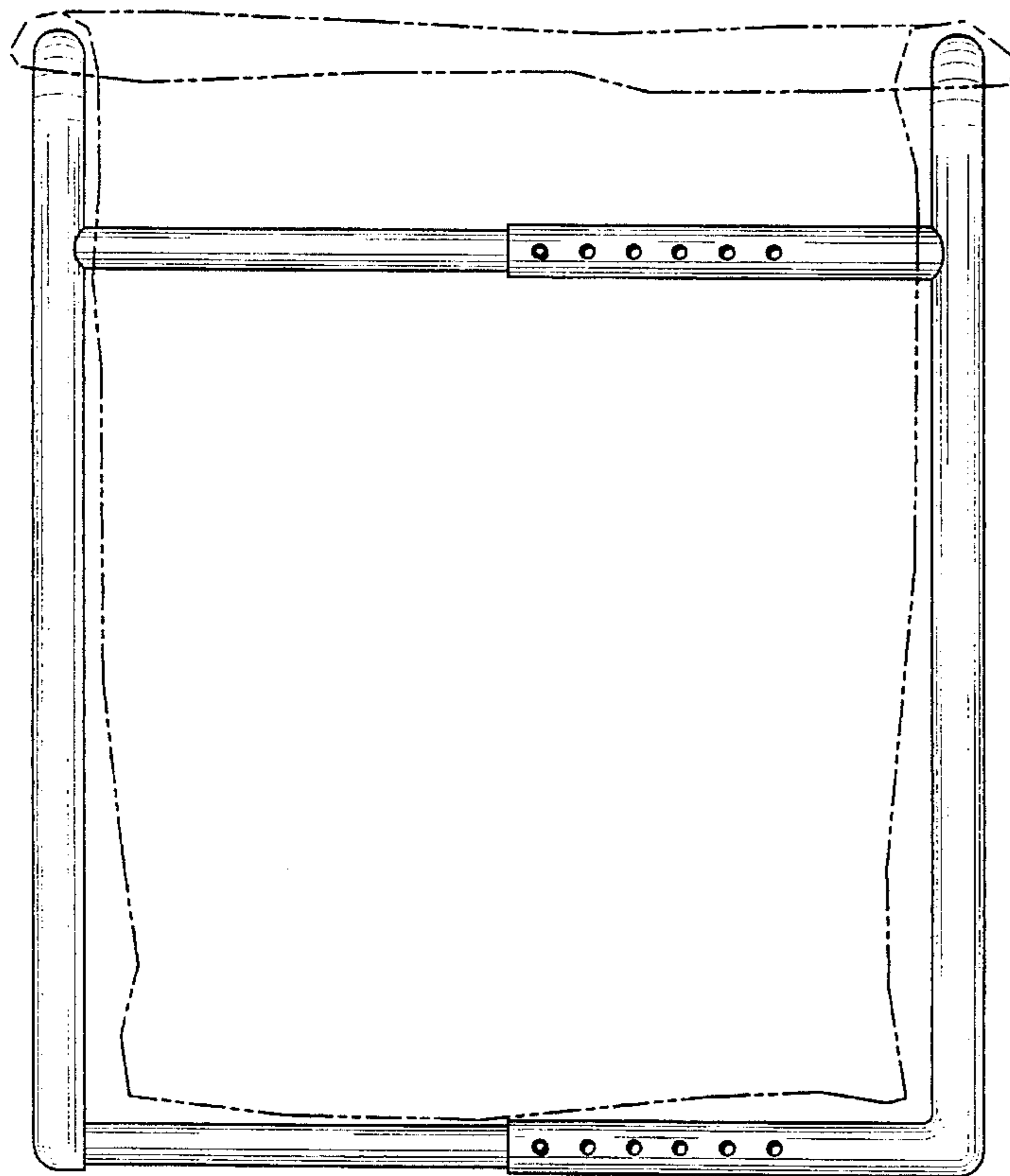

FIG. 4

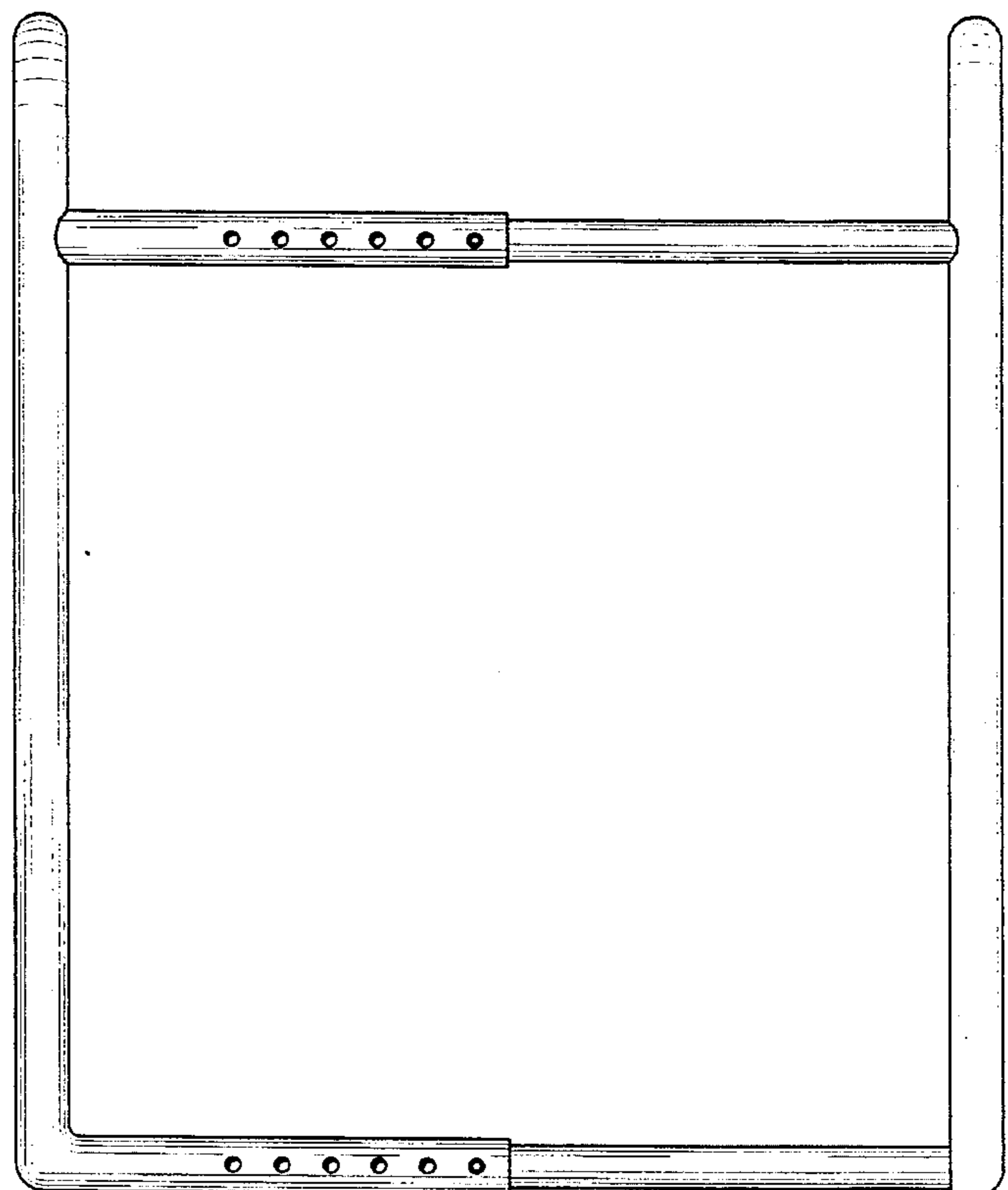

FIG. 5

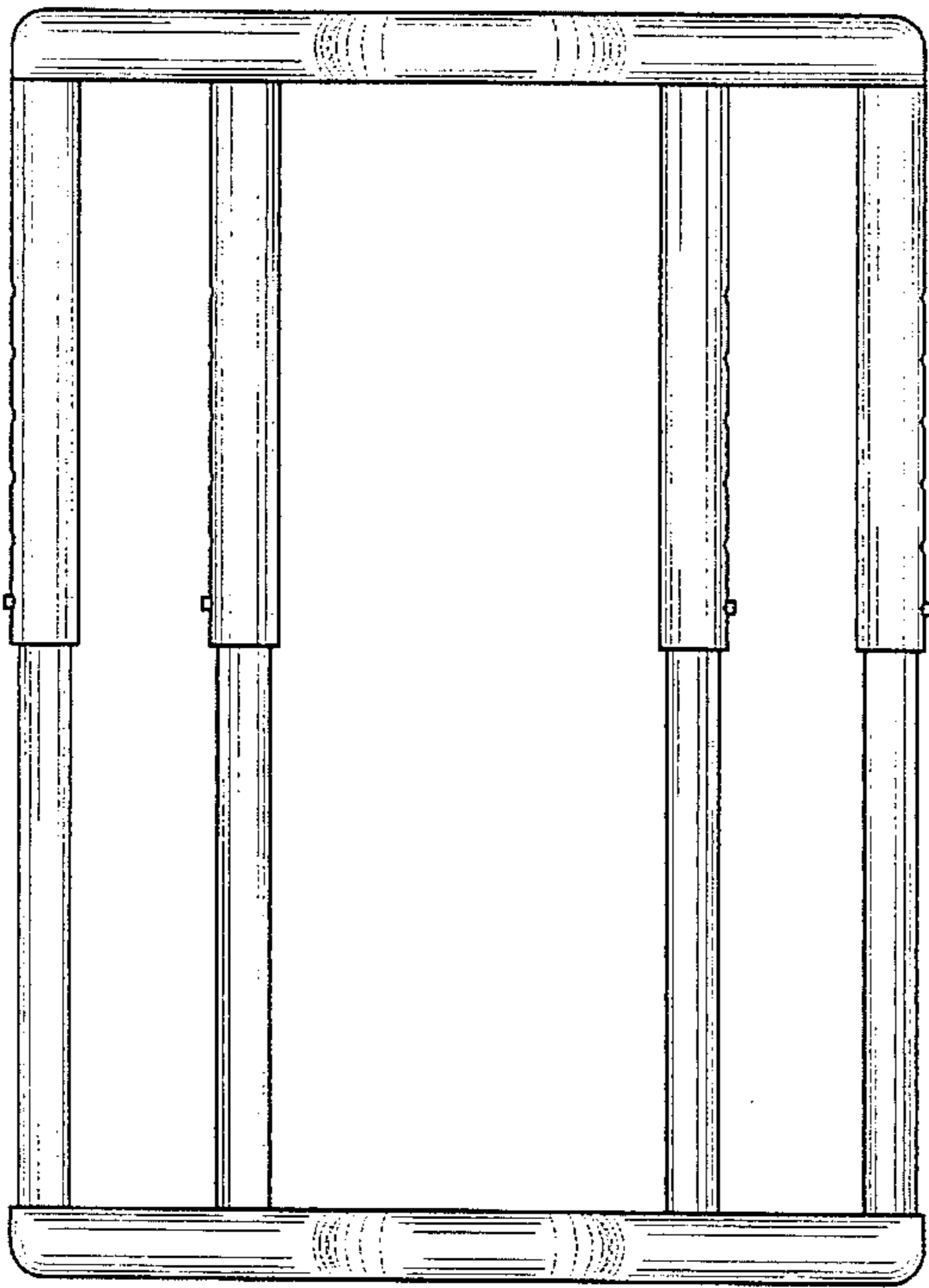

FIG. 6

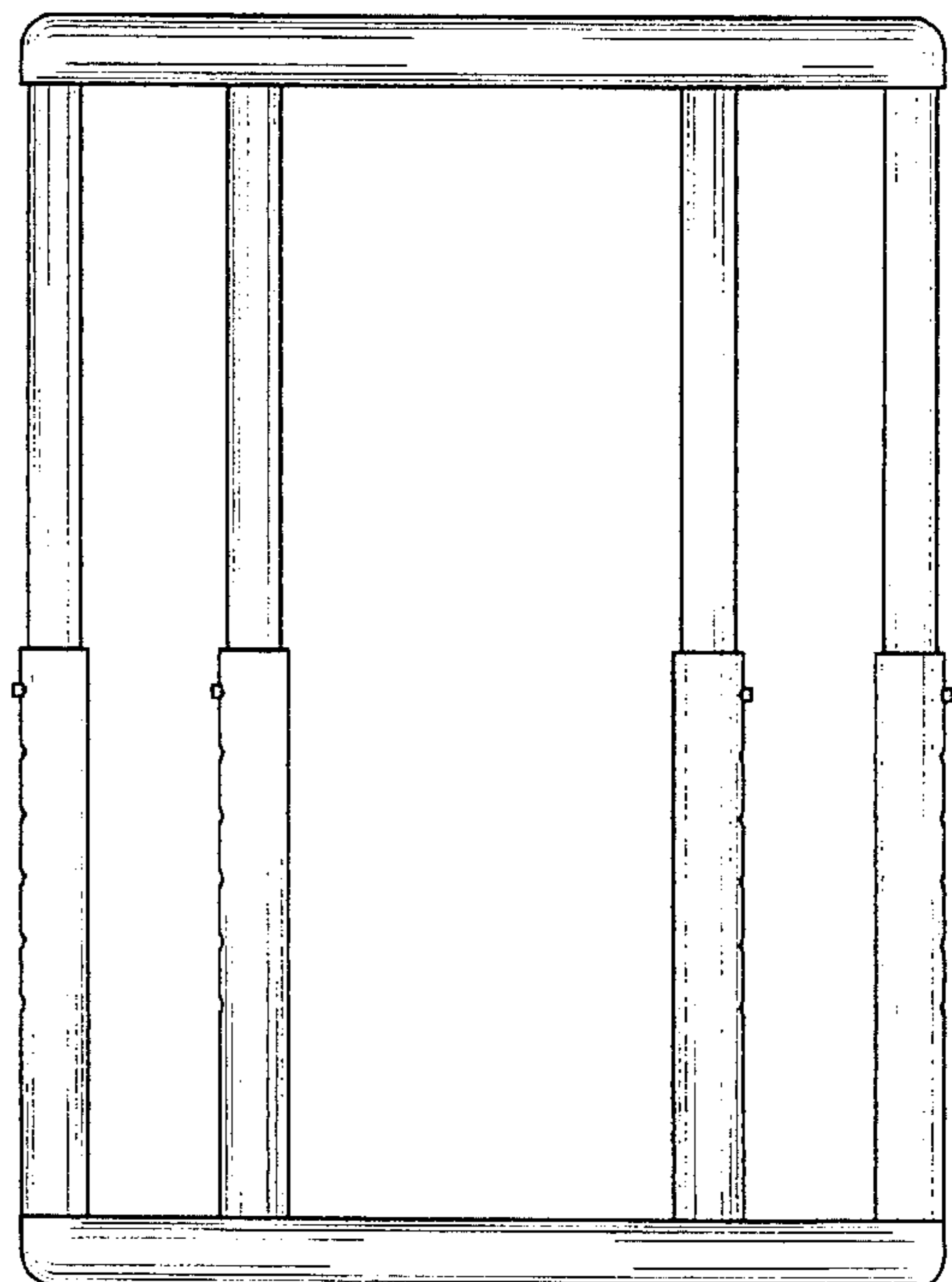

FIG. 7

