



US00D370999S

# United States Patent [19]

[11] Patent Number: **Des. 370,999**

Umiker

[45] Date of Patent: **\*\*Jun. 25, 1996**

[54] **CRATE HAND GRIP**

[75] Inventor: **Hans Umiker**, Egg/Zurich, Switzerland

[73] Assignee: **Schoeller-Plast SA**, Romont, Switzerland

[\*\*] Term: **14 Years**

[21] Appl. No.: **3,792**

[22] Filed: **Jan. 15, 1993**

[30] **Foreign Application Priority Data**

Jul. 16, 1992 [DE] Germany ..... M9205312.2

[52] U.S. Cl. .... **D3/318; D3/307**

[58] Field of Search ..... D3/304, 307-313, D3/282, 318; D8/300, 313-317; 206/510; 220/752, 755; D25/119, 120, 125, 126, 128, 136; D9/434, 443; 292/DIG. 63

[56] **References Cited**

**U.S. PATENT DOCUMENTS**

- D. 270,867 10/1983 Keohan ..... D3/308
- D. 275,048 8/1984 Bannigan ..... D3/308
- D. 301,201 5/1989 King ..... D8/316 X

**FOREIGN PATENT DOCUMENTS**

0260698 9/1987 European Pat. Off. .

*Primary Examiner*—Ted Shooman  
*Assistant Examiner*—Richelle Shelton  
*Attorney, Agent, or Firm*—Price, Heneveld, Cooper, DeWitt & Litton

[57] **CLAIM**

The ornamental design for a crate hand grip, as shown and described.

**DESCRIPTION**

FIG. 1 is a perspective view of a crate hand grip showing my new design;  
FIG. 2 is an enlarged perspective view thereof;  
FIG. 3 is an enlarged front elevational view thereof;

FIG. 4 is an enlarged top plan view thereof;  
FIG. 5 is an enlarged bottom plan view thereof;  
FIG. 6 is an enlarged left side elevational view thereof, the opposite side elevational view being a mirror image thereof;  
FIG. 7 is an enlarged perspective view of a second embodiment thereof;  
FIG. 8 is an enlarged perspective view of a third embodiment thereof;  
FIG. 9 is an enlarged perspective view of a fourth embodiment thereof;  
FIG. 10 is a front elevational view of the second embodiment of the design shown in FIG. 7;  
FIG. 11 is a top plan view of the second embodiment of the design shown in FIG. 7;  
FIG. 12 is a bottom plan view of the second embodiment of the design shown in FIG. 7;  
FIG. 13 is a left side elevational view of the second embodiment of the design shown in FIG. 7, the opposite side elevational view being a mirror image, thereof;  
FIG. 14 is a front elevational view of the third embodiment of the design shown in FIG. 8;  
FIG. 15 is a top plan view of the third embodiment of the design shown in FIG. 8;  
FIG. 16 is a bottom plan view of the third embodiment of the design shown in FIG. 8;  
FIG. 17 is a left side elevational view of the third embodiment of the design shown in FIG. 8, the opposite side elevational view being a mirror image, thereof;  
FIG. 18 is a front elevational view of the fourth embodiment of the design shown in FIG. 9;  
FIG. 19 is a top plan view of the fourth embodiment of the design shown in FIG. 9;  
FIG. 20 is a bottom plan view of the fourth embodiment of the design shown in FIG. 9; and,  
FIG. 21 is a left side elevational view of the fourth embodiment of the design shown in FIG. 9, the opposite side elevational view being a mirror image, thereof.  
The ornamental design is shown in FIGS. 1-21.  
The rear is unornamented and rear elevation views are, therefore, omitted. The broken lines showing the environmental structure of the crate hand grip is for illustrative purposes only and forms no part of the claimed design.

**1 Claim, 6 Drawing Sheets**

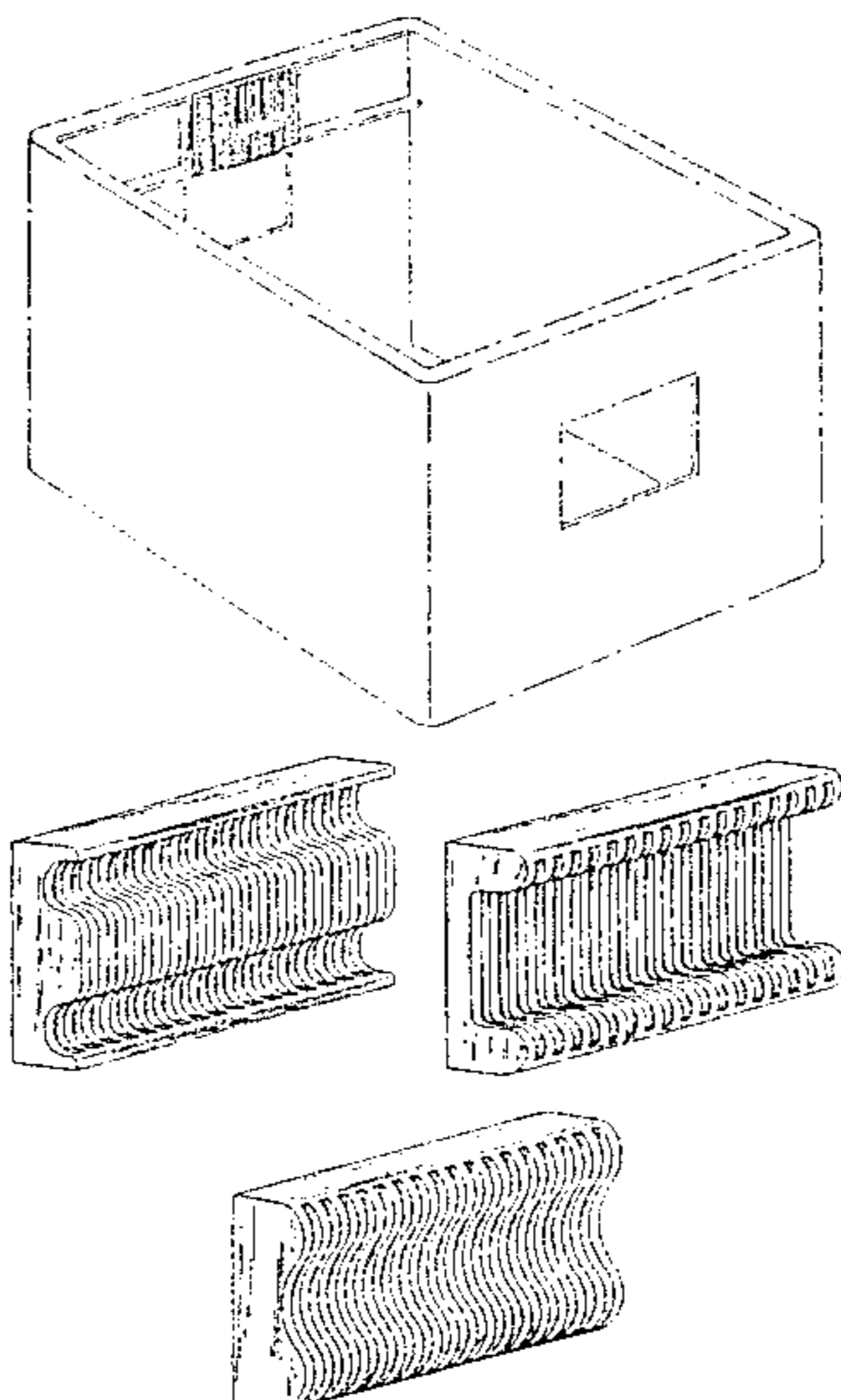

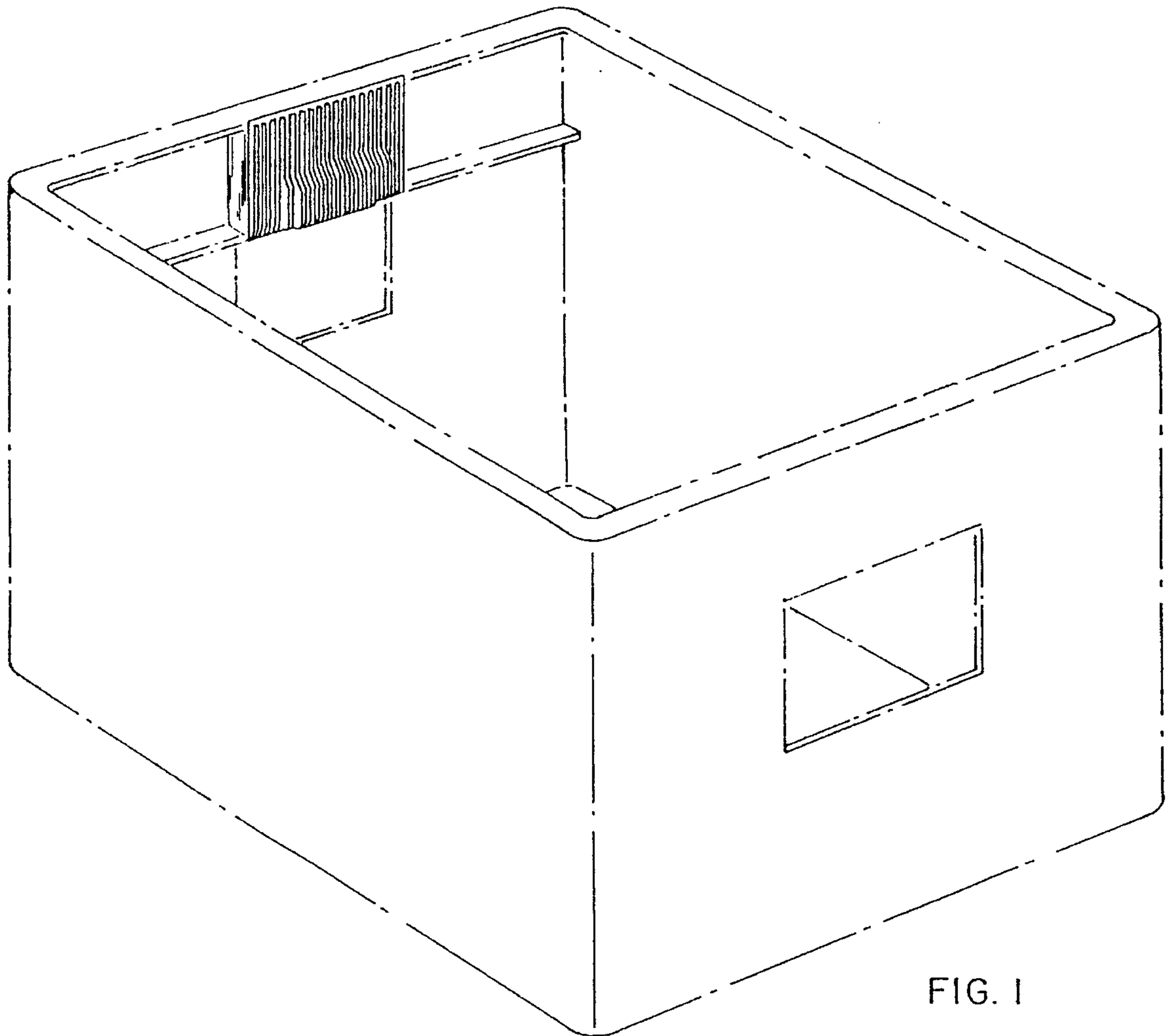

FIG. 1

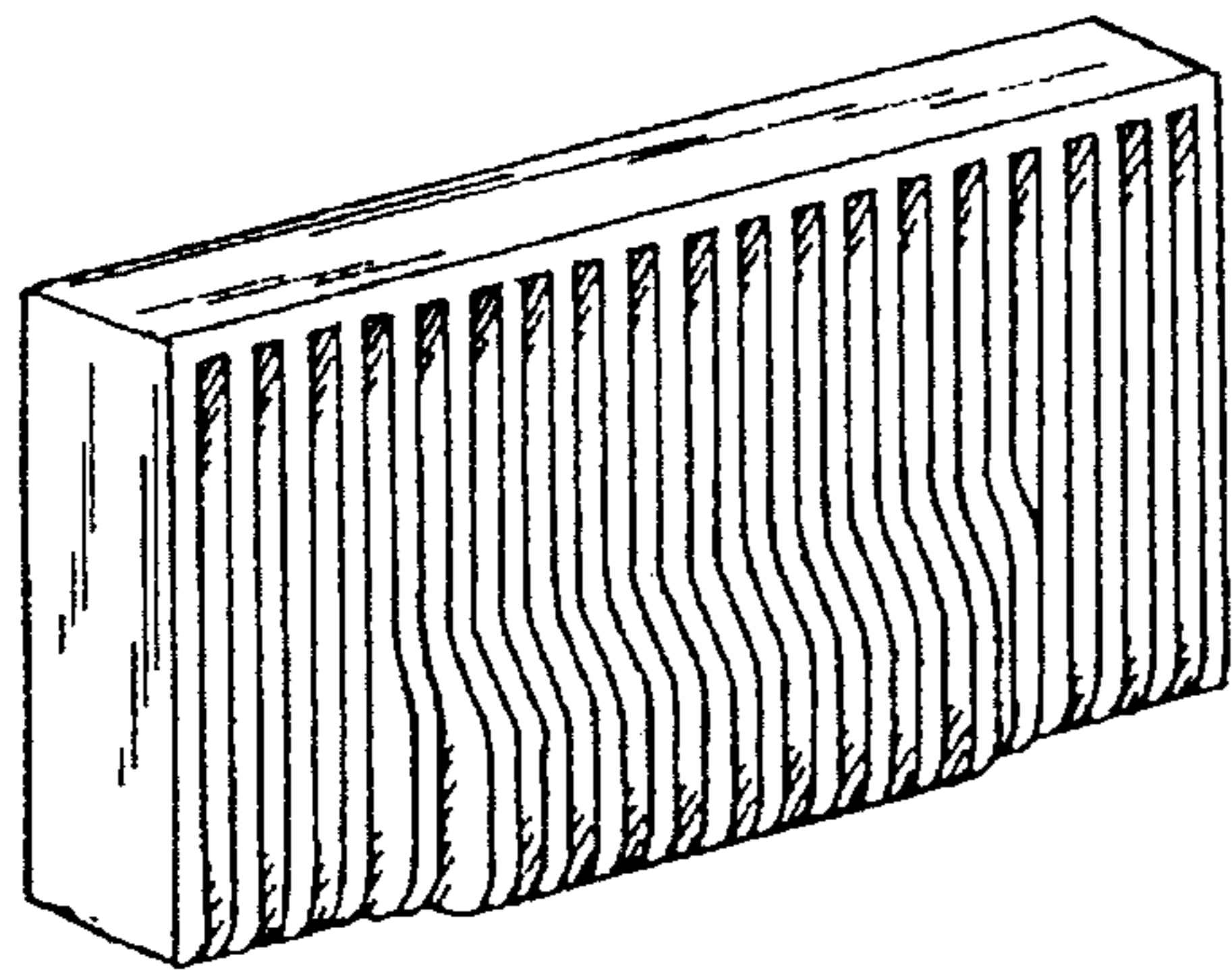

FIG. 2

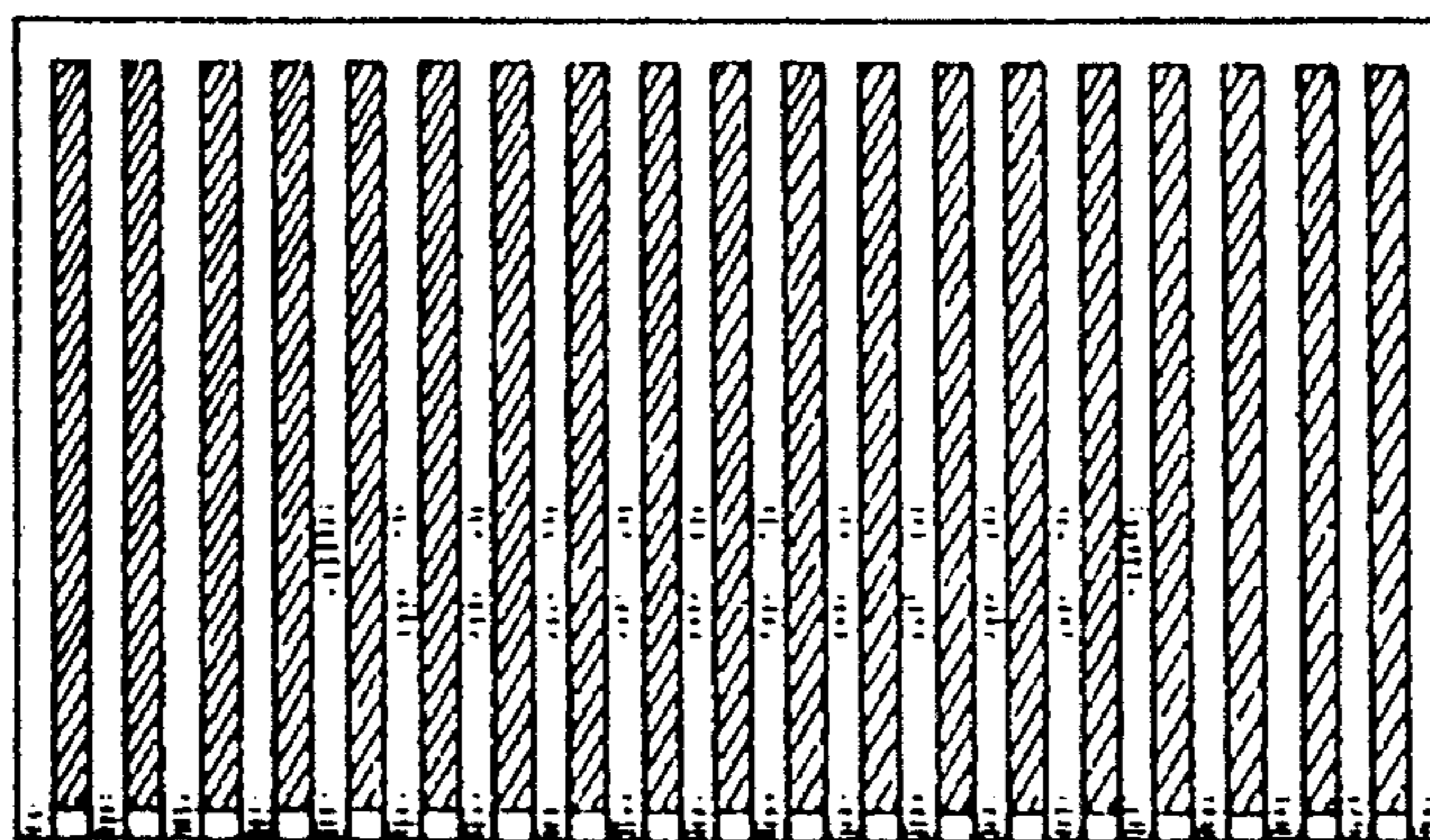

FIG. 3

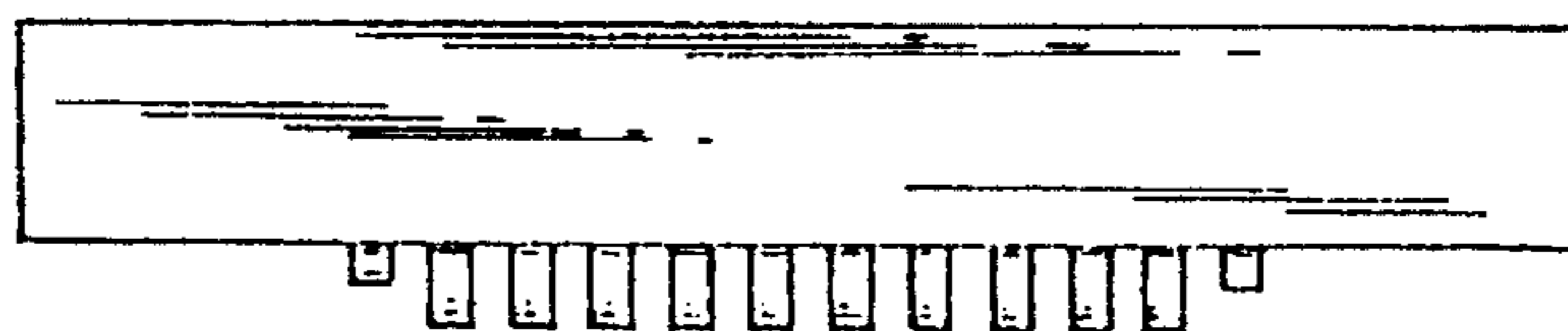

FIG. 4

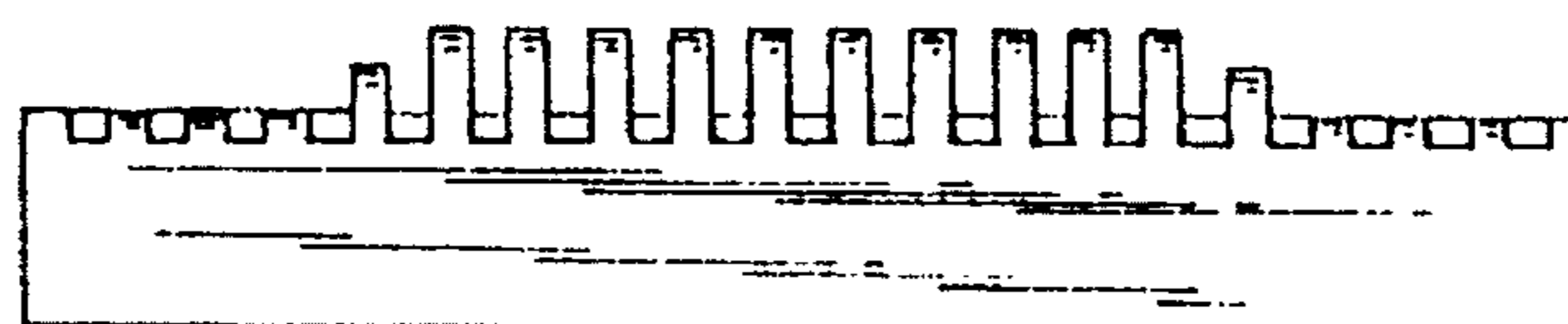

FIG. 5



FIG. 6

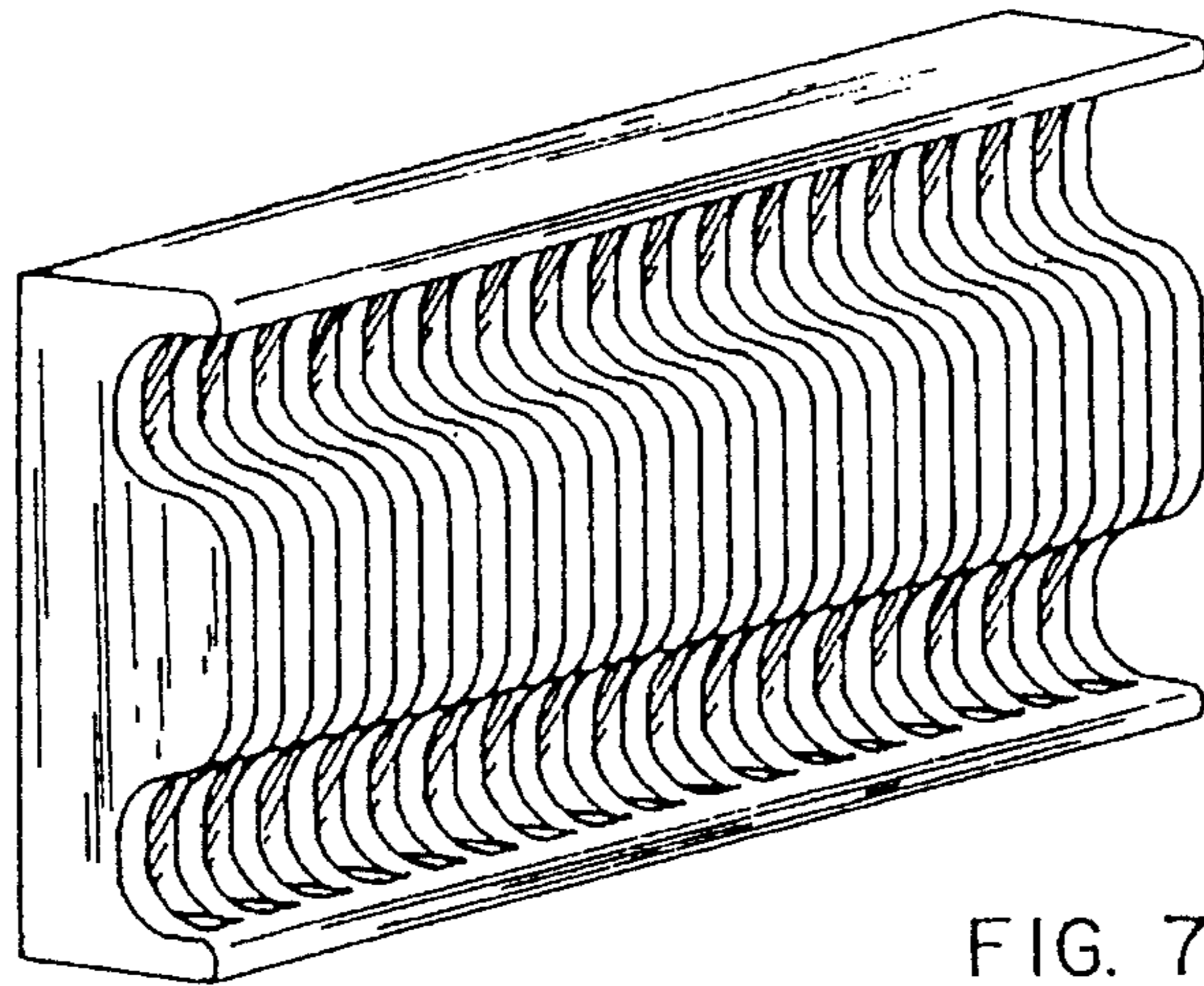

FIG. 7

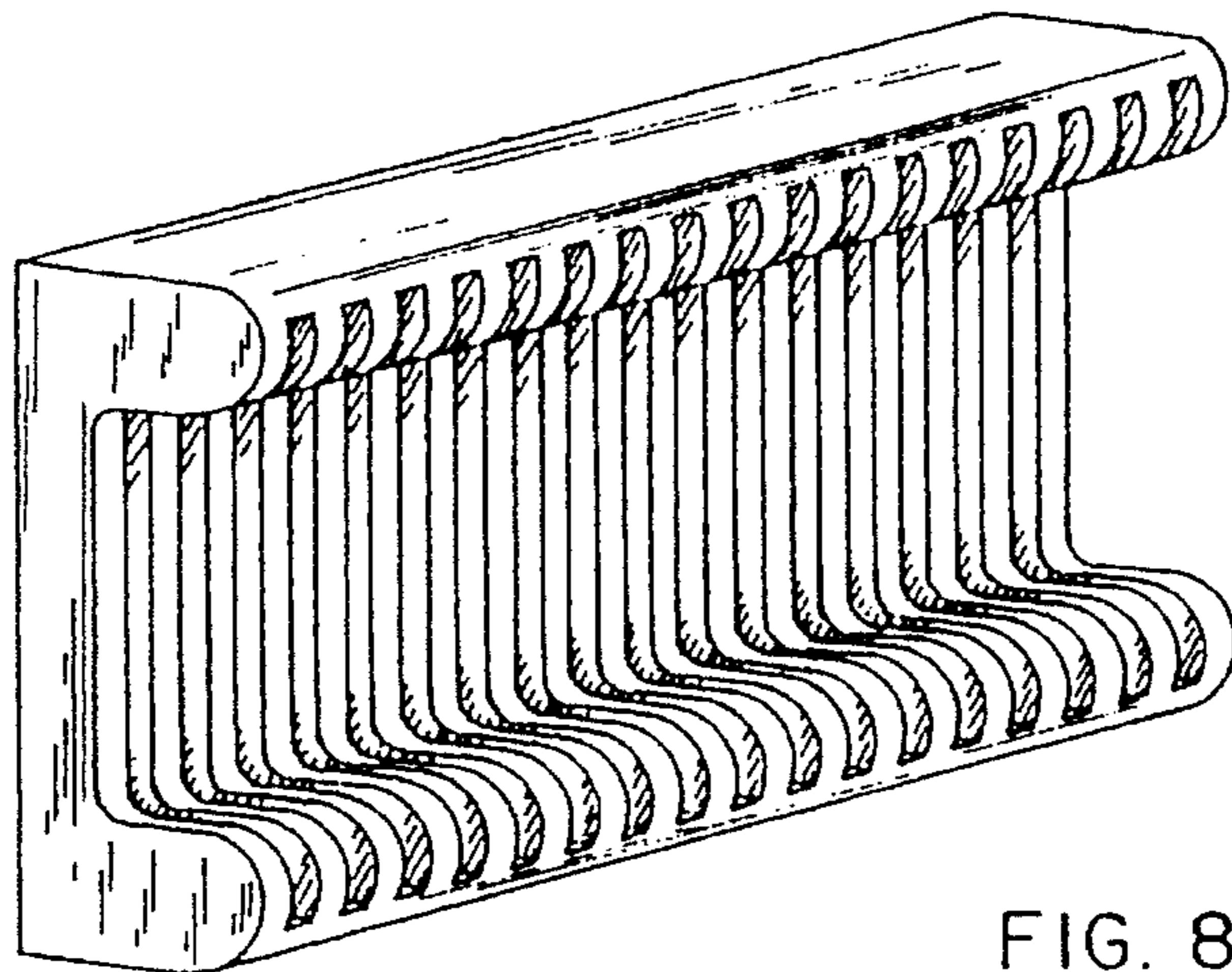

FIG. 8

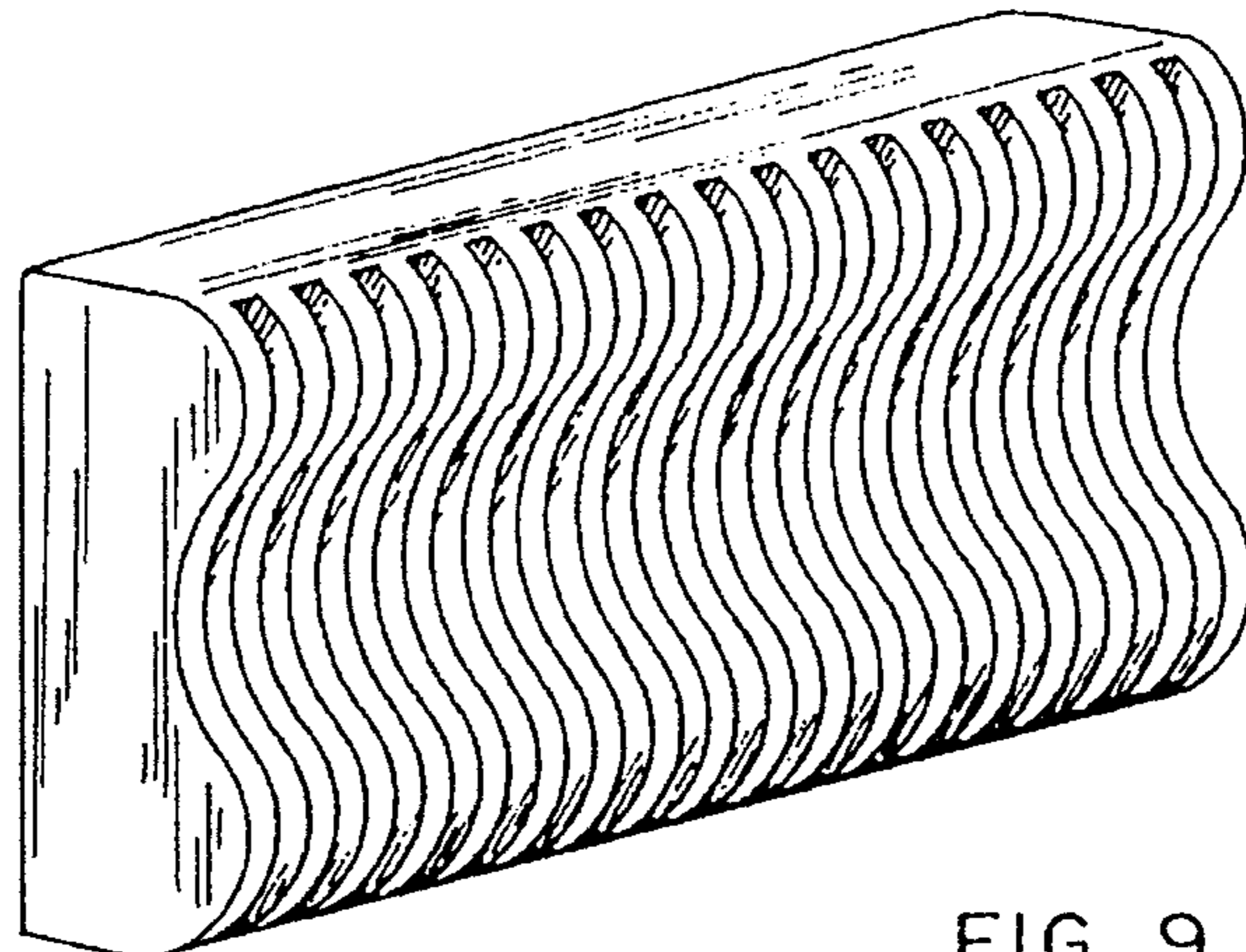

FIG. 9

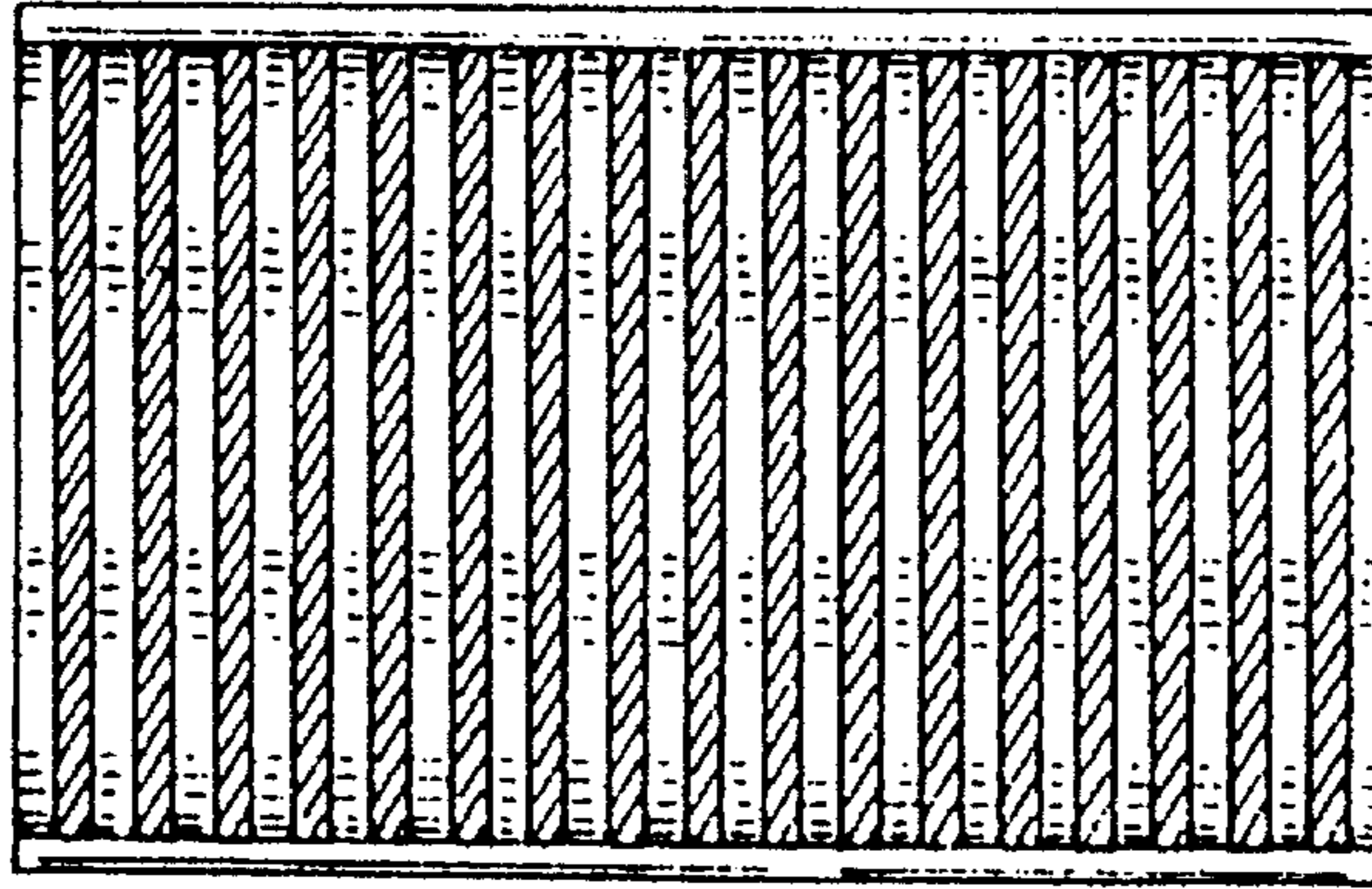

FIG. 10

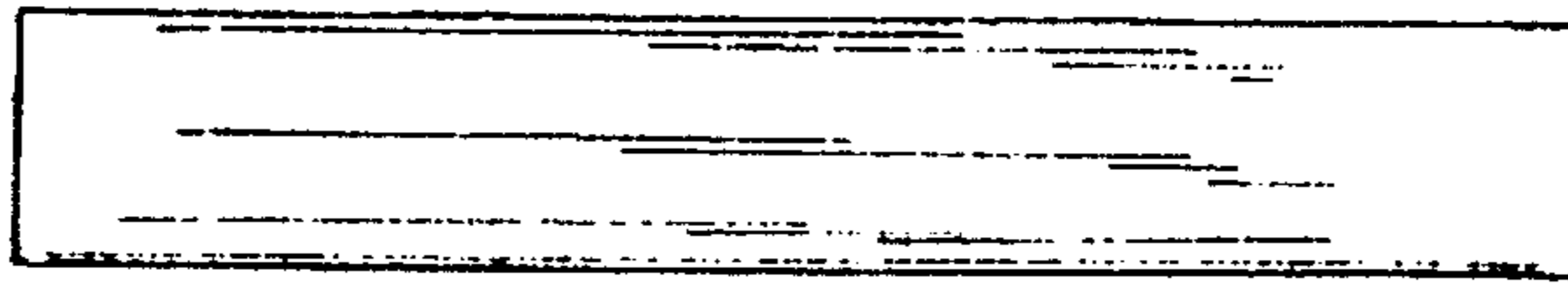

FIG. 11

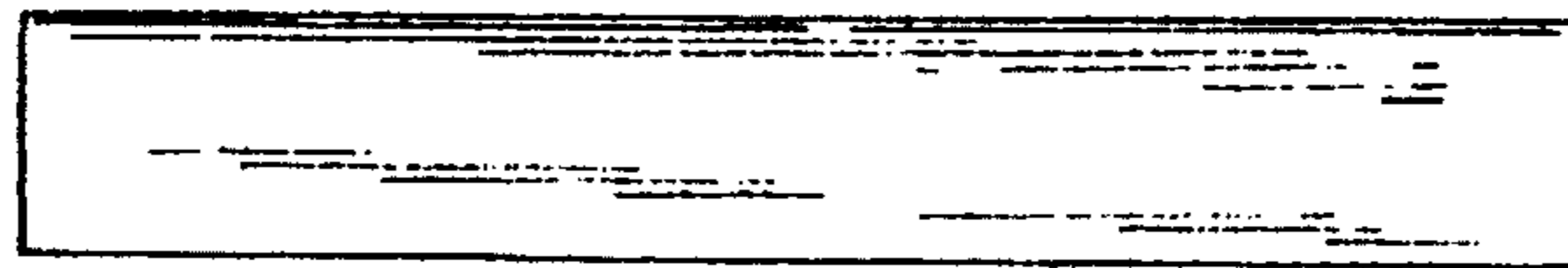

FIG. 12



FIG. 13

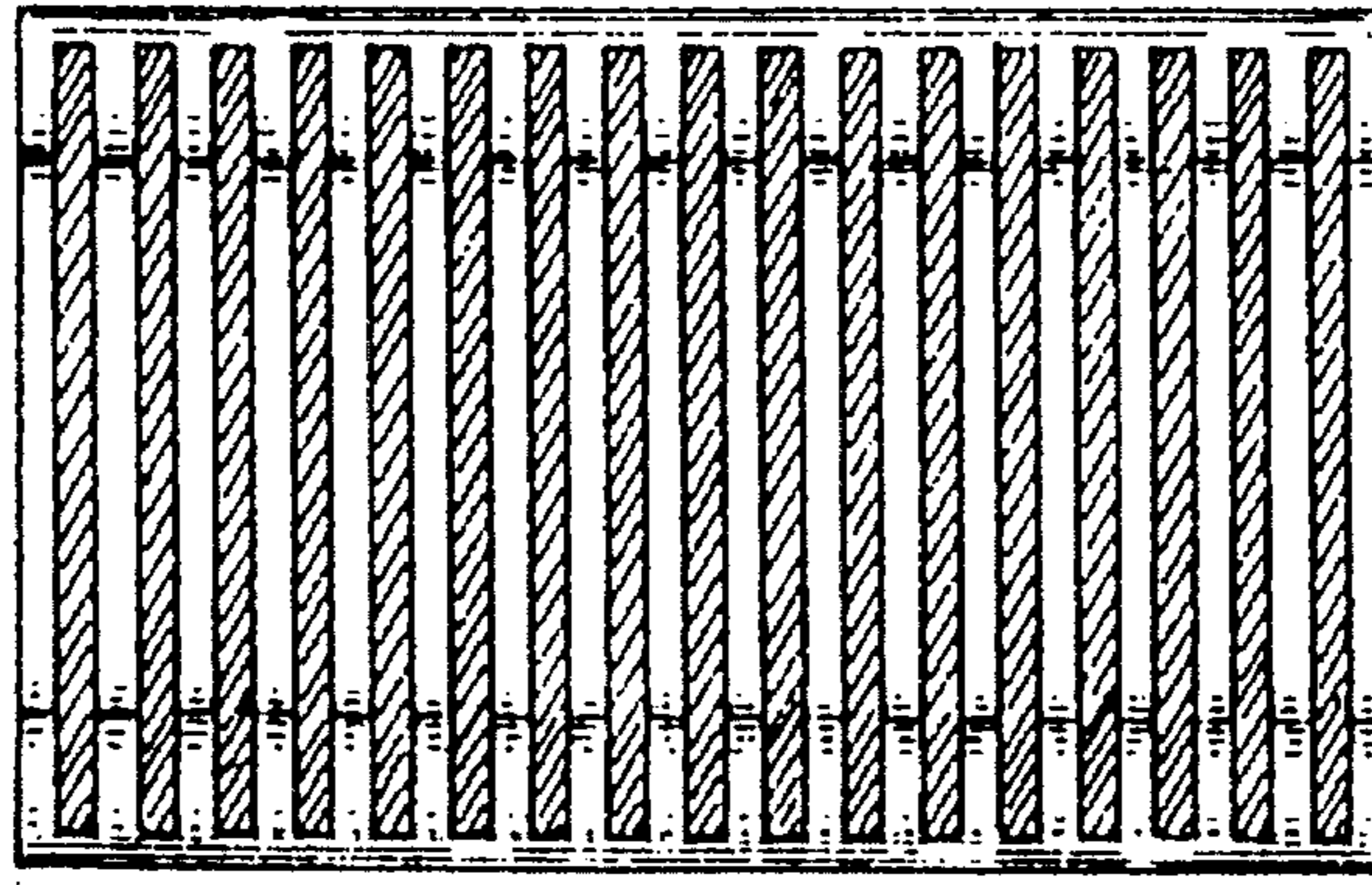

FIG. 14

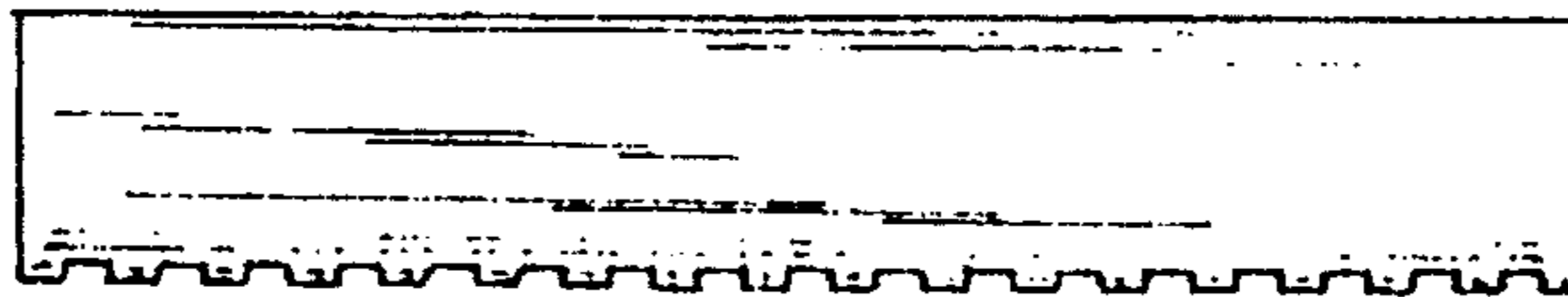

FIG. 15

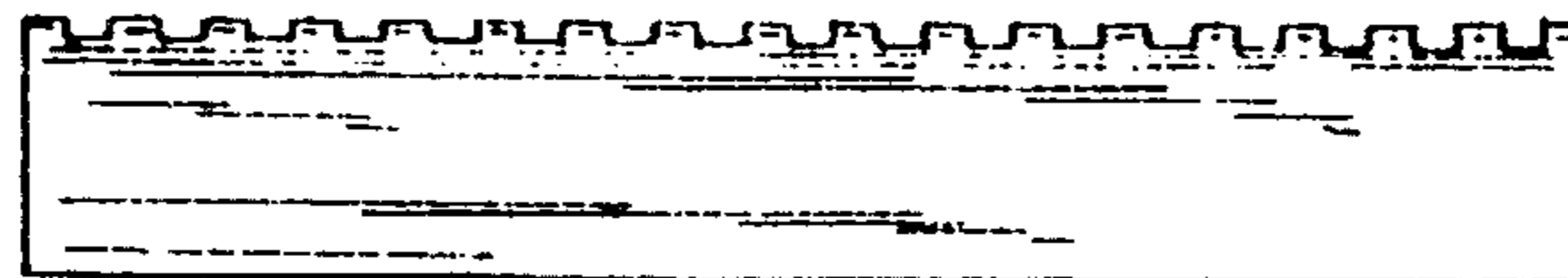

FIG. 16

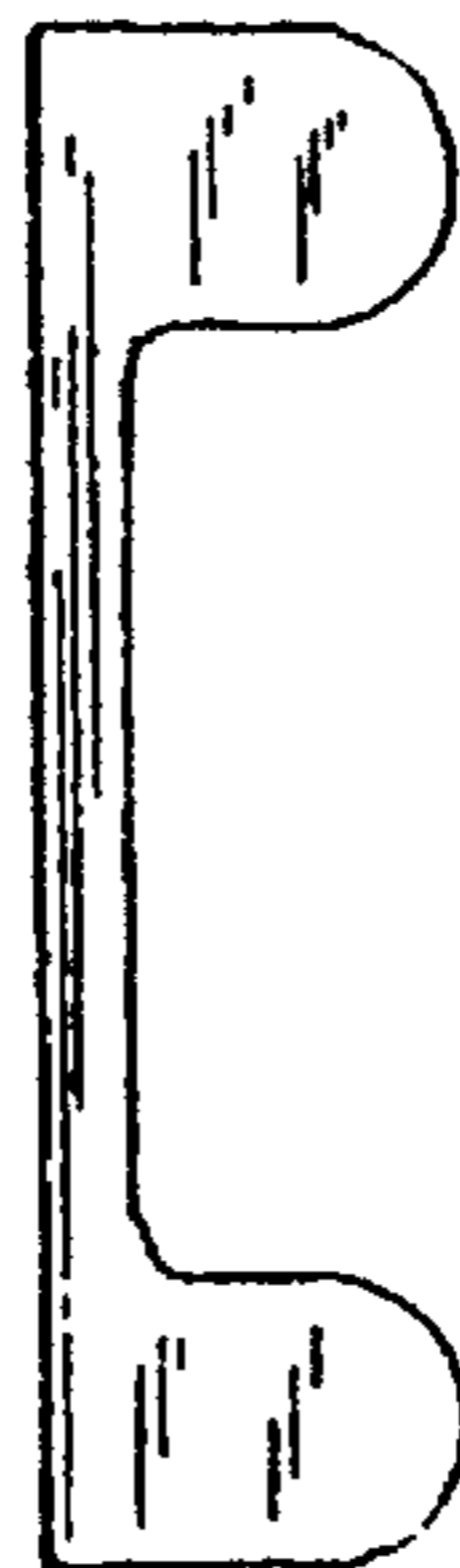

FIG. 17

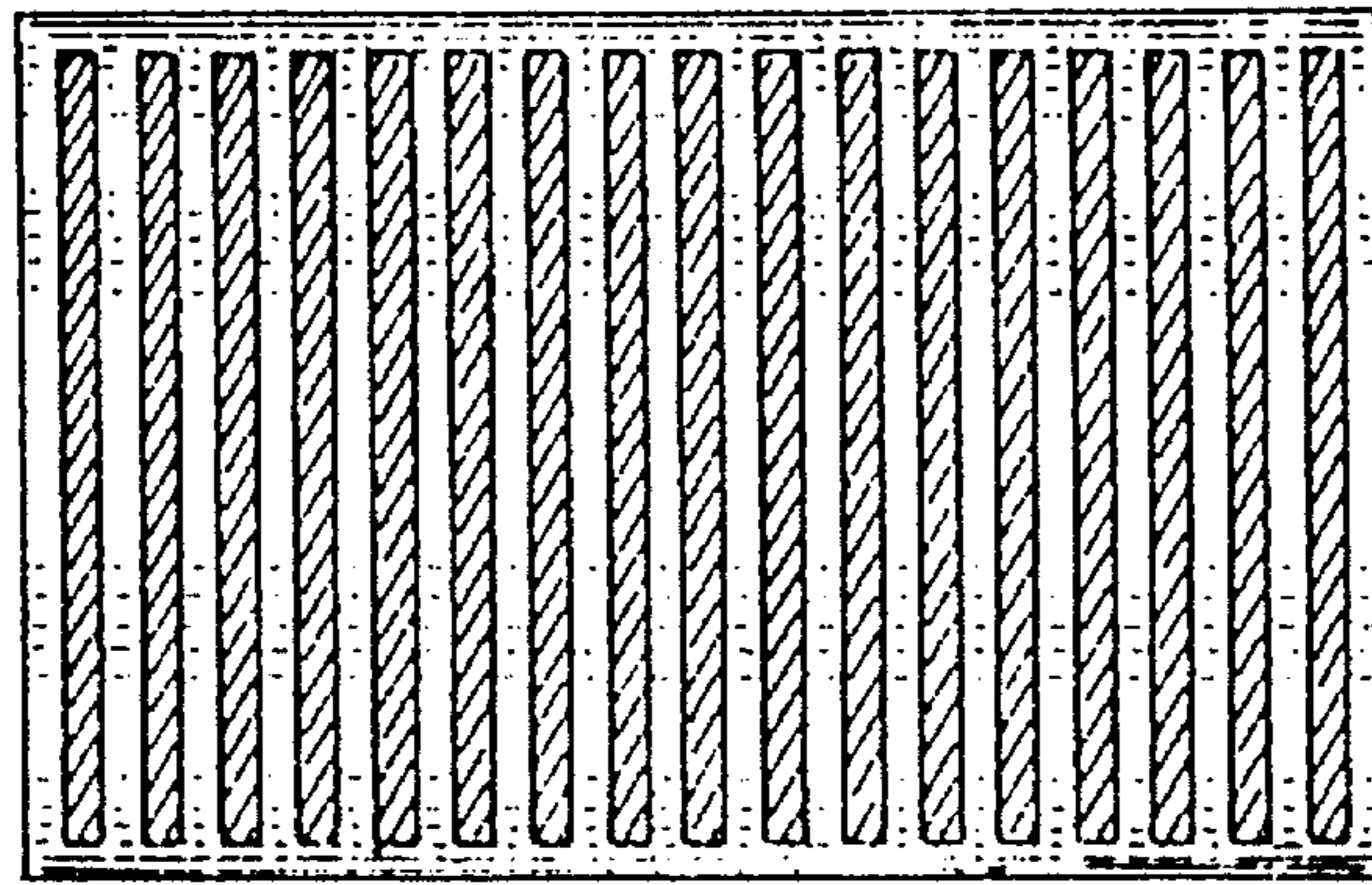

FIG. 18

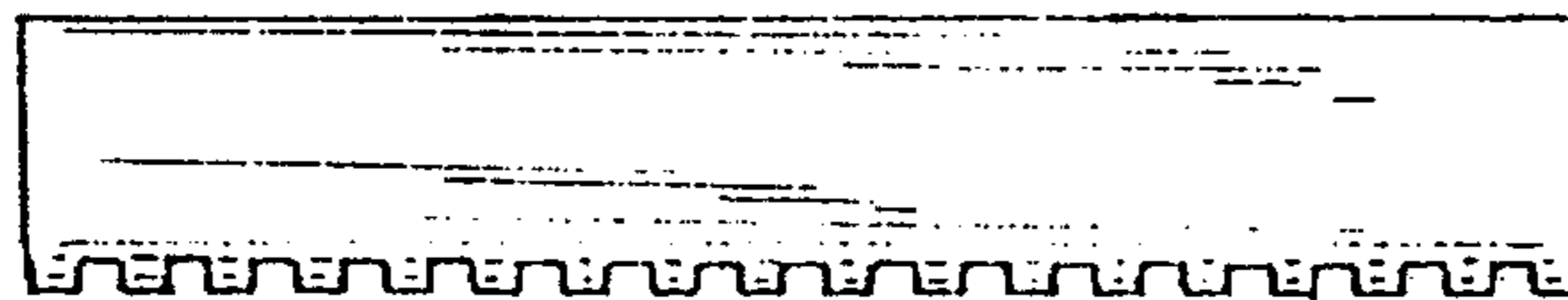

FIG. 19

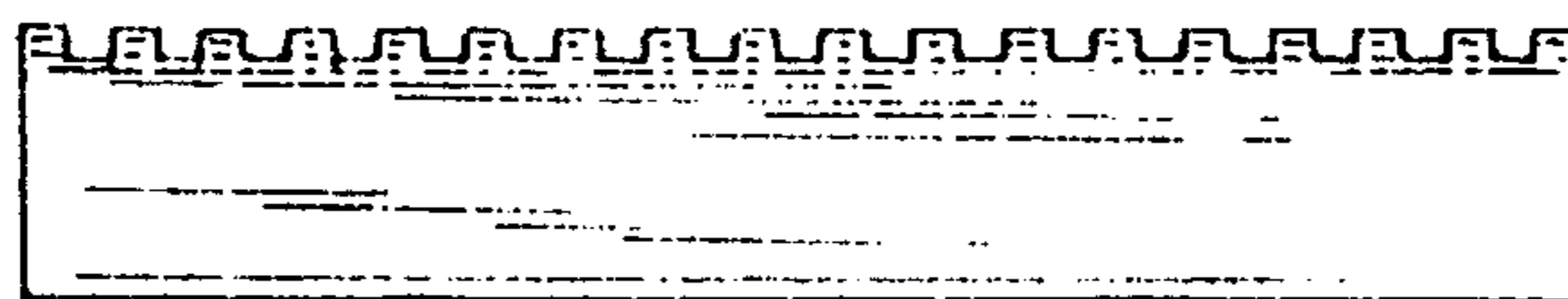

FIG. 20

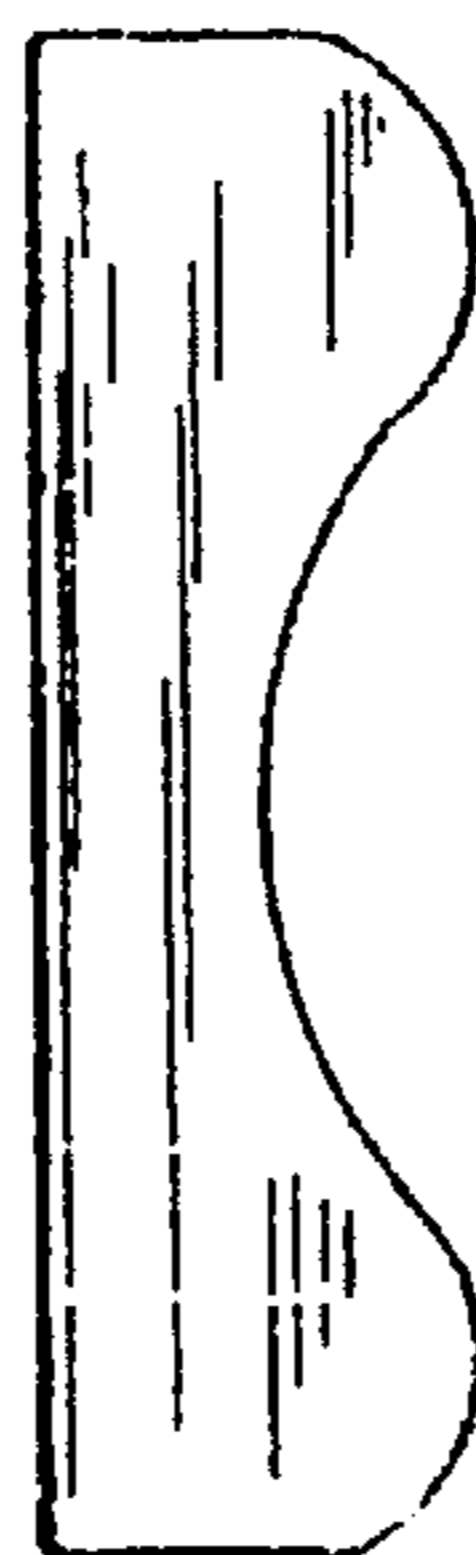

FIG. 21