



US00D370991S

**United States Patent** [19]

[11] **Patent Number: Des. 370,991**

**Christianson**

[45] **Date of Patent: \*\*Jun. 25, 1996**

[54] **BERRY PICKING APRON**

[76] Inventor: **Lendal V. Christianson**, 801 East St.,  
Bottineau, N. Dak. 58318

[\*\*] Term: **14 Years**

[21] Appl. No.: **20,594**

[22] Filed: **Mar. 29, 1994**

[52] U.S. Cl. .... **D2/864; D2/861**

[58] Field of Search ..... **D2/860-861, 862,  
D2/863, 864, 830; D29/100, 101; 2/48,  
49.1, 51; D3/226, 213, 214**

D. 341,923	12/1993	Kuykendall .....	D2/830
D. 351,061	10/1994	Coons .....	D3/226
D. 355,752	2/1995	Abbott .....	D2/857
889,470	6/1998	Lyons .....	D2/743
3,229,873	1/1966	Hershman .....	D3/213
4,234,229	11/1980	Arnold .....	D3/214
4,469,259	9/1984	Krich et al. ....	D3/214
5,176,102	1/1993	Tracy .....	D3/214

*Primary Examiner*—Celia Murphy

[57] **CLAIM**

The ornamental design for a berry picking apron, as shown and described.

**DESCRIPTION**

FIG. 1 is a front elevational view of the berry picking apron showing my new design;  
FIG. 2 is a rear elevational view thereof;  
FIG. 3 is a left side elevational view thereof;  
FIG. 4 is a right side elevational view thereof;  
FIG. 5 is a top plan view thereof;  
FIG. 6 is a bottom plan view thereof; and,  
FIG. 7 is a perspective view thereof.

**1 Claim, 4 Drawing Sheets**

[56] **References Cited**

**U.S. PATENT DOCUMENTS**

D. 173,089	9/1954	Reich .....	D3/226
D. 260,695	9/1981	Brookfield .....	D3/213
D. 266,800	11/1982	Kula et al. ....	D3/214
D. 270,109	8/1983	Bluemel .....	D29/100
D. 275,812	10/1984	Deacon .....	D3/213
D. 299,792	2/1989	Winter .....	D29/101
D. 300,475	3/1989	Caulder et al. ....	D29/101
D. 315,242	3/1991	Ruge .....	D29/101

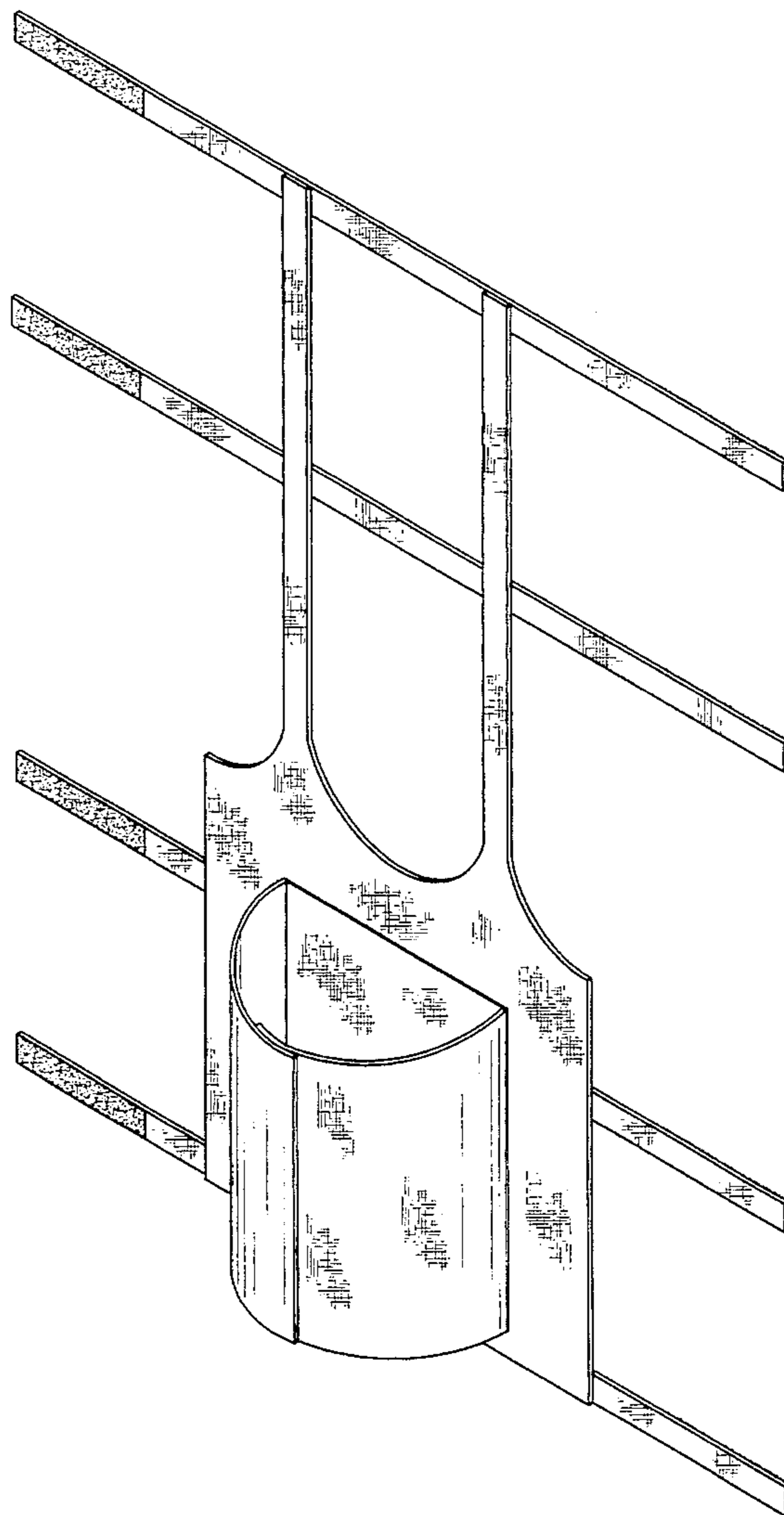

FIG. 1

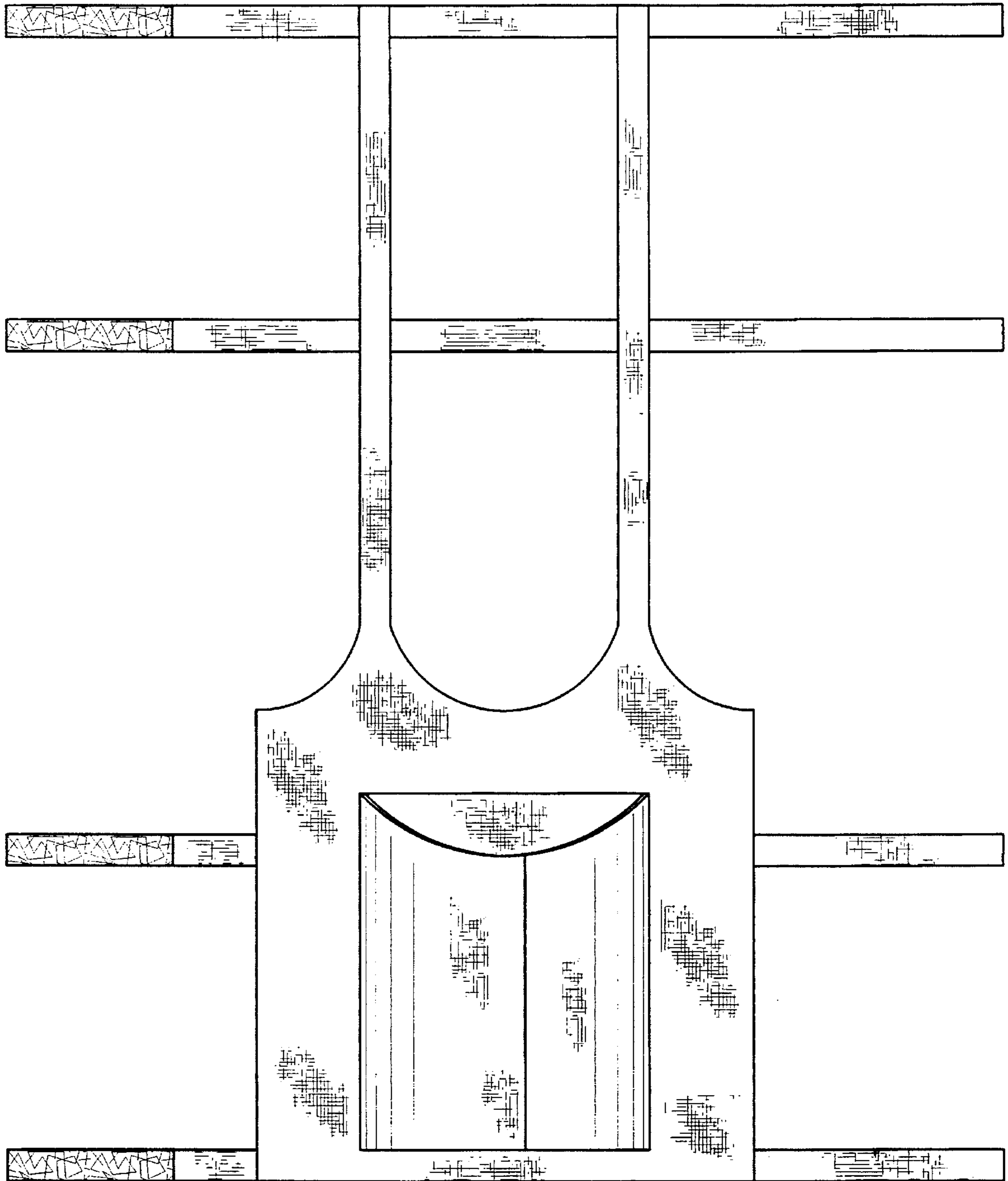

FIG. 2

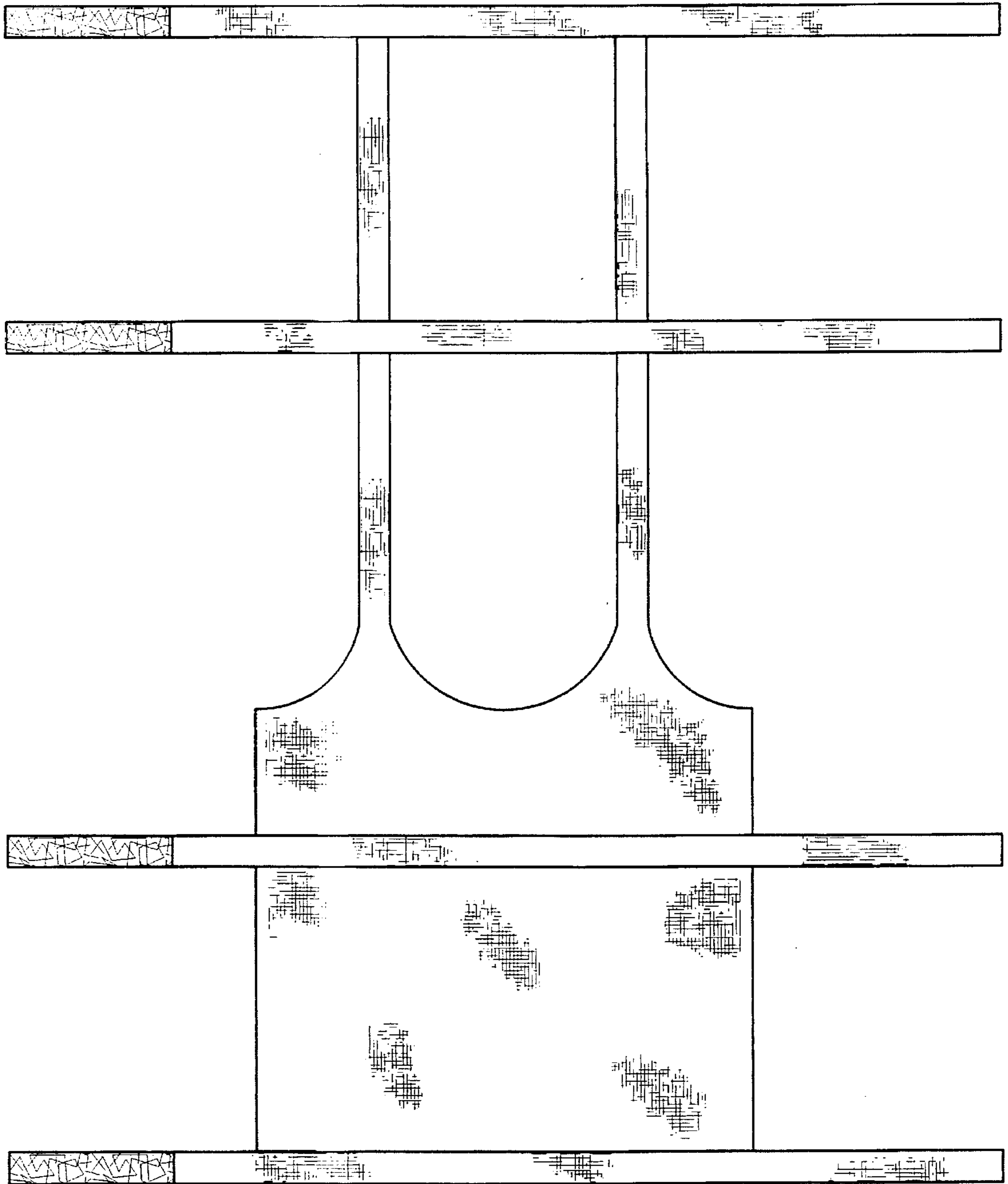

FIG. 3

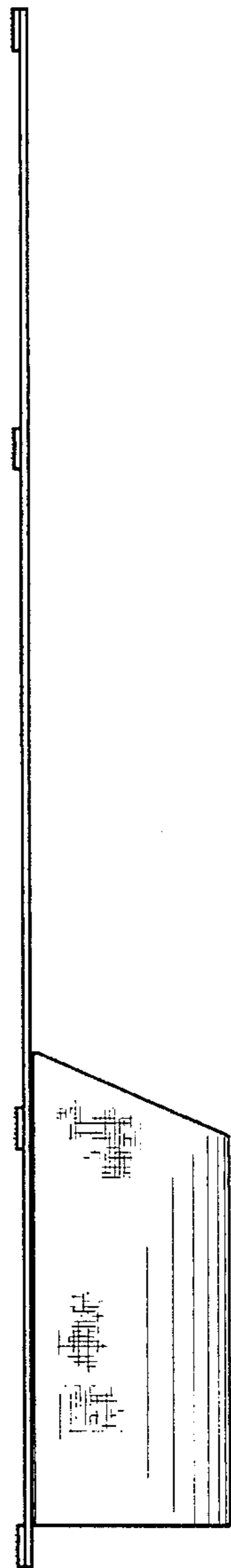

FIG. 4

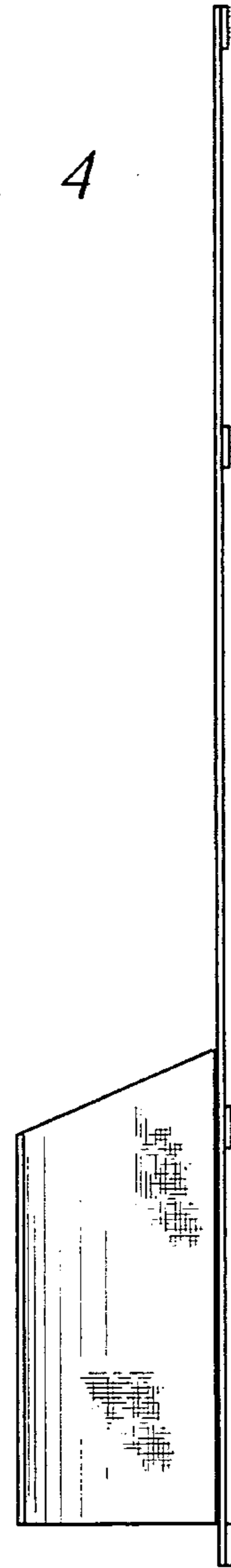

FIG. 5

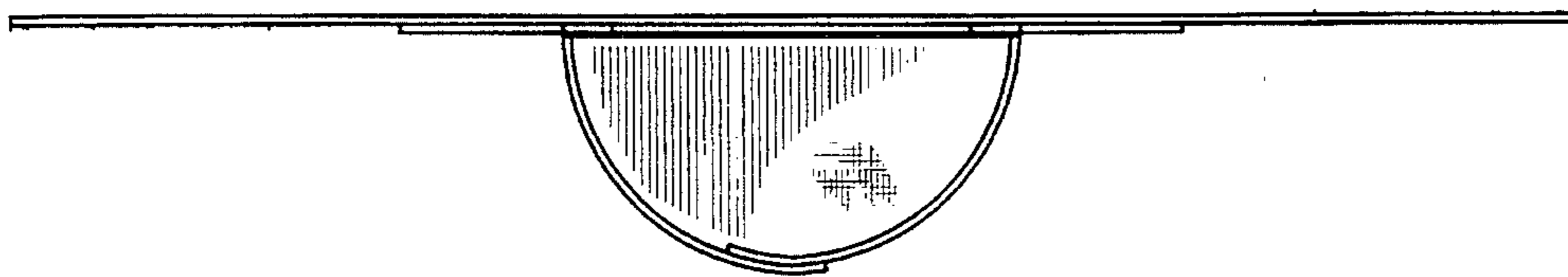

FIG. 6

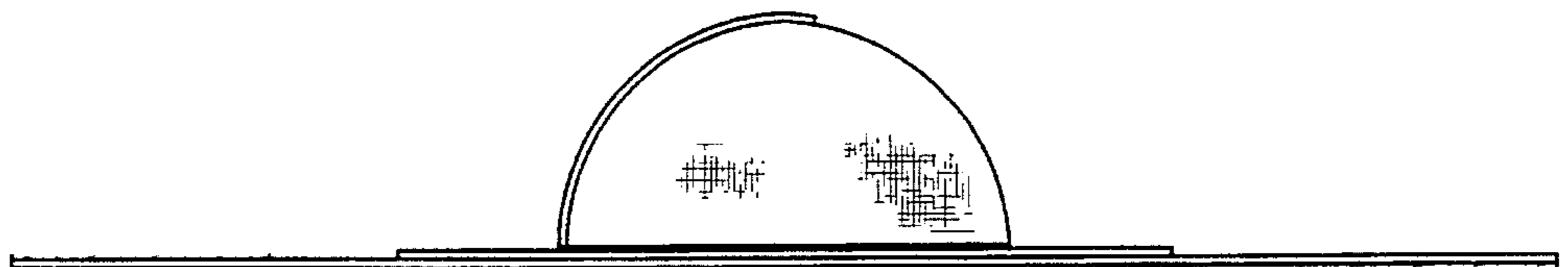

FIG. 7

