



US00D370940S

United States Patent [19]

Stambolic et al.

[11] Patent Number: **Des. 370,940**

[45] Date of Patent: ****Jun. 18, 1996**

[54] **HAND-HELD ELECTRONIC GAME HOUSING**

[75] Inventors: **Zarko Stambolic**, Oak Park; **Shari L. Smith**, Chicago; **Howard J. Morrison**, Riverwoods, all of Ill.

[73] Assignee: **Tiger Electronics, Inc.**, Vernon Hills, Ill.

[**] Term: **14 Years**

[21] Appl. No.: **31,346**

[22] Filed: **Nov. 23, 1994**

[52] U.S. Cl. **D21/13**

[58] Field of Search D21/13, 48, 1;
273/148 B, 433-438, DIG. 28; D14/124,
125

[56] **References Cited**

U.S. PATENT DOCUMENTS

D. 270,075	8/1983	Tsuyuki	D21/13
D. 320,624	10/1991	Taylor	D21/13
5,161,803	11/1992	Ohara	273/DIG. 28 X
5,213,327	5/1993	Kitaue	273/434 X
5,232,223	8/1993	Dornbusch	273/438 X

OTHER PUBLICATIONS

Playthings, Mar. 1980, p. 16 Lakeside's Le Boom.
HongKong Enterprise Oct. 1992, p. 279 Pen-Cu-Lator.
HongKong Enterprises, Oct. 1992, p. 353.
MIDWAY MORTAL KOMBAT product, shown on p. 84
(copyright 1992) from Jan. 1994 edition of Tiger Electronics, Inc. book entitled *Lightning Strikes Again*.

Primary Examiner—Prabhakar G. Deshmukh
Attorney, Agent, or Firm—Fitch, Even, Tabin & Flannery

[57] **CLAIM**

The ornamental design for the hand-held electronic game housing, as shown and described.

DESCRIPTION

FIG. 1 is a perspective view of a hand-held electronic game housing showing our new design;
FIG. 2 is a top plan view thereof;
FIG. 3 is a front elevational view thereof;
FIG. 4 is a bottom plan view thereof;
FIG. 5 is a rear elevational view thereof;
FIG. 6 is a left side elevational view thereof; and,
FIG. 7 is a right side elevational view thereof.

1 Claim, 2 Drawing Sheets

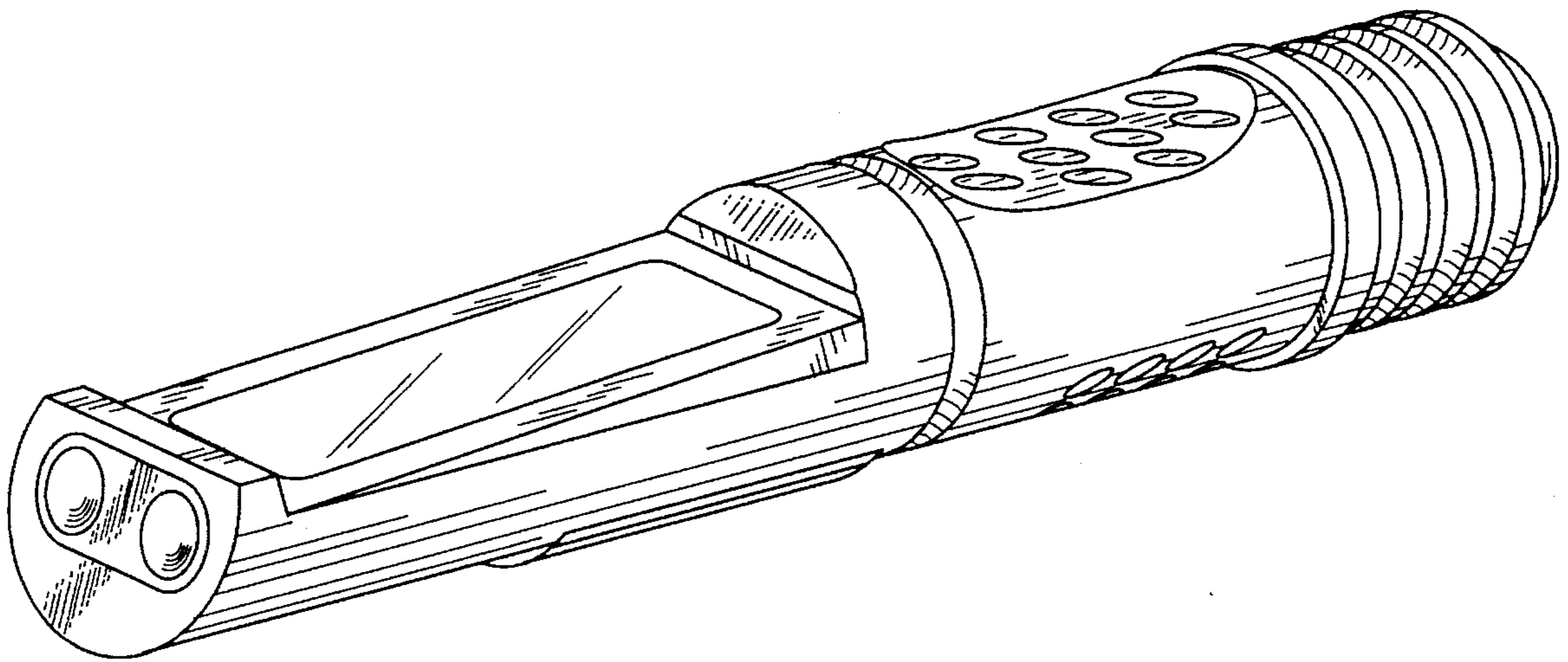

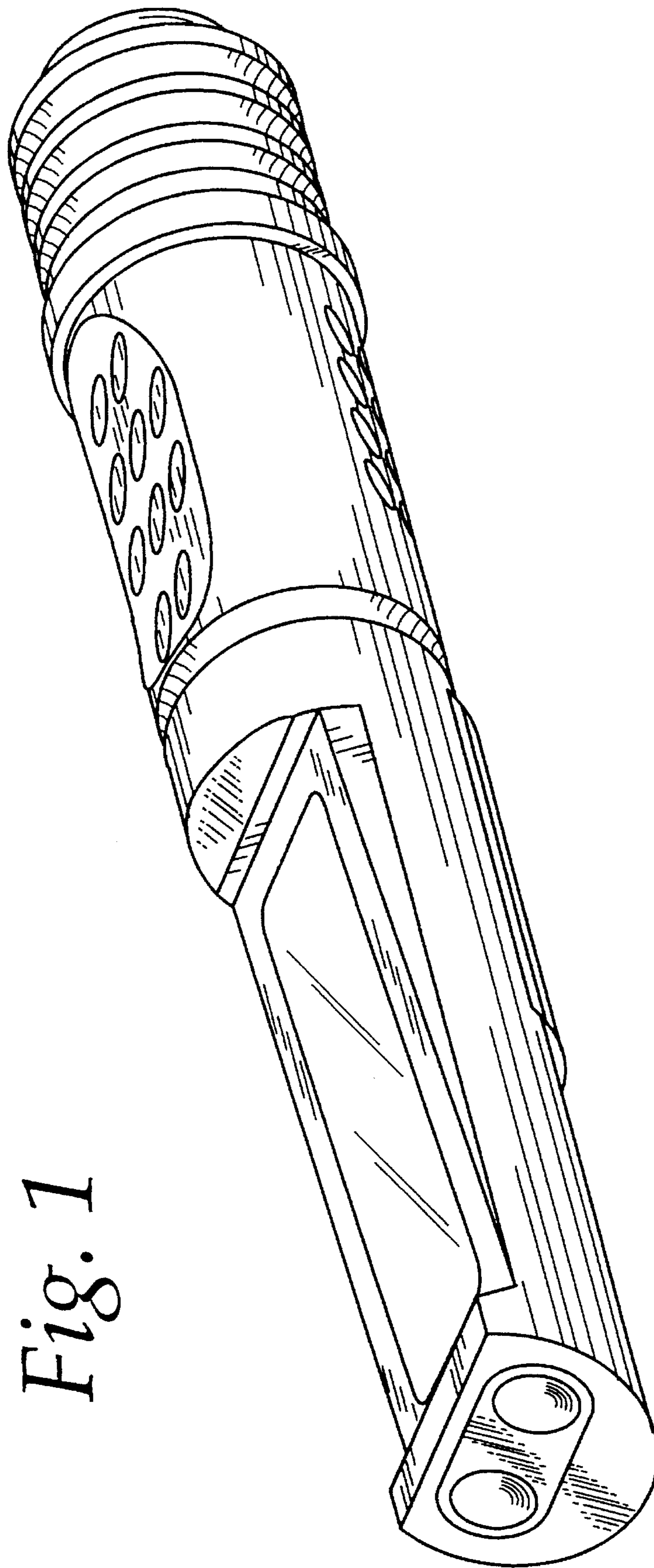

Fig. 1

Fig. 2

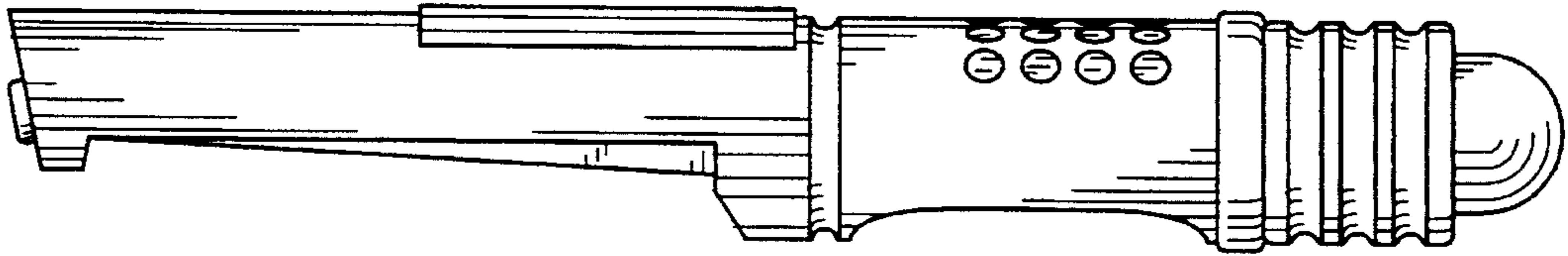

Fig. 3

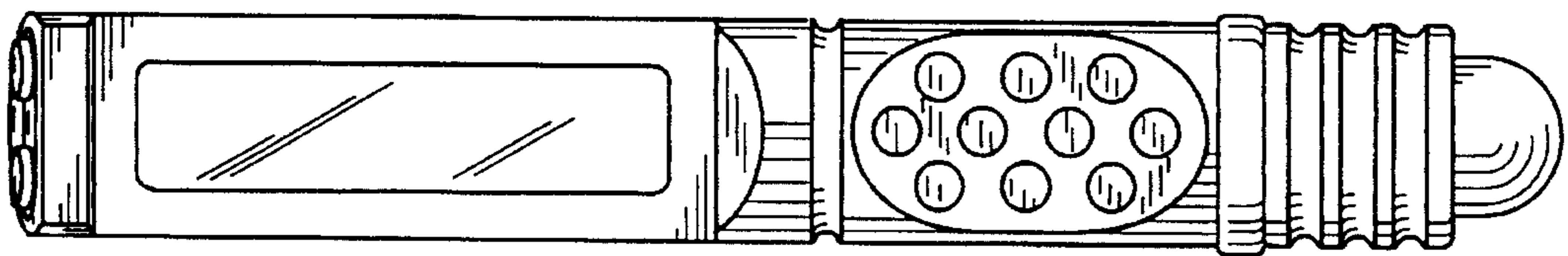

Fig. 4

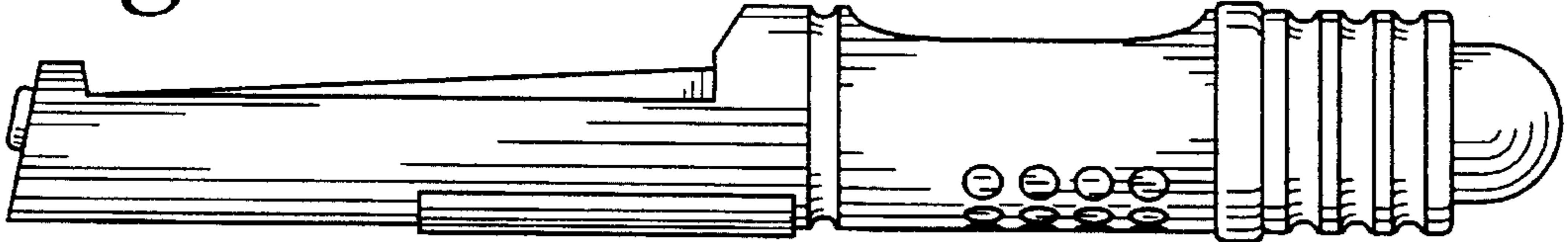

Fig. 5

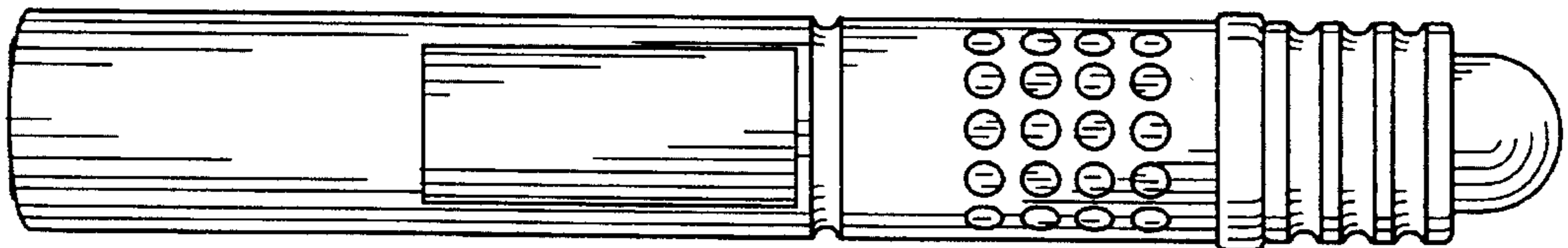

Fig. 6

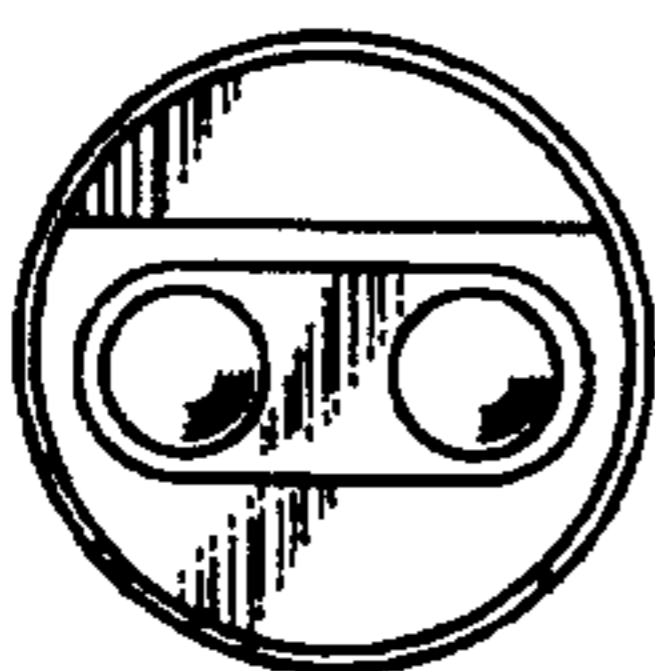

Fig. 7

