



US00D370812S

# United States Patent [19]

Simmonds

[11] Patent Number: **Des. 370,812**

[45] Date of Patent: **\*\*Jun. 18, 1996**

[54] **TOOTHBRUSH AND CUP HOLDER**

2,965,109 12/1960 Borah ..... 132/289  
4,929,039 5/1990 Thomas et al. .  
5,107,987 4/1992 Palazzolo et al. .

[76] Inventor: **Dorett M. Simmonds**, 4780 NW. 20th St., Lauderhill, Fla. 33313

[\*\*] Term: **14 Years**

*Primary Examiner*—Brian N. Vinson

[21] Appl. No.: **35,365**

[57] **CLAIM**

[22] Filed: **Feb. 24, 1995**

The ornamental design for the toothbrush and cup holder, as shown and described.

[52] U.S. Cl. .... **D6/531**

**DESCRIPTION**

[58] **Field of Search** ..... D6/527-528, 531, D6/534-535; D9/341; D28/9, 61; 206/209, 581, 235, 351, 823; 132/289

FIG. 1 is a front elevational view of the toothbrush and cup holder showing my new design;  
FIG. 2 is a rear elevational view thereof;  
FIG. 3 is a left side elevational view thereof;  
FIG. 4 is a right side elevational view thereof;  
FIG. 5 is a top plan view thereof;  
FIG. 6 is a bottom plan view thereof; and,  
FIG. 7 is a front and upper right perspective view thereof with the lid in an open position.

[56] **References Cited**

**U.S. PATENT DOCUMENTS**

- D. 253,504 11/1979 Grosfillex .
- D. 295,234 4/1988 Luhrsen et al. .
- D. 306,811 3/1990 DeLeon ..... D6/527 X
- D. 324,792 3/1992 McElroy ..... D6/528
- D. 336,398 6/1993 Shafer .

**1 Claim, 4 Drawing Sheets**

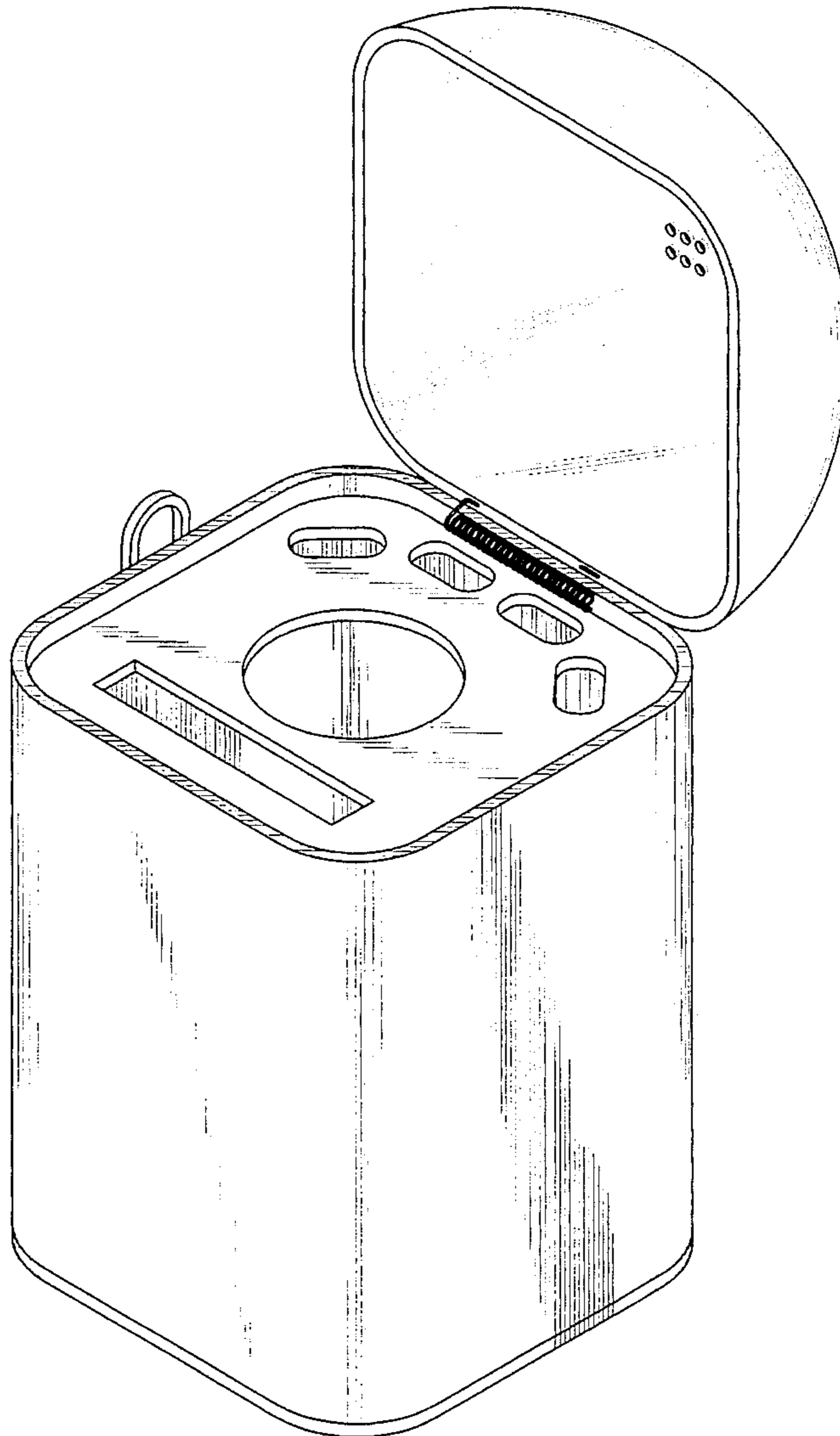

FIG. 1

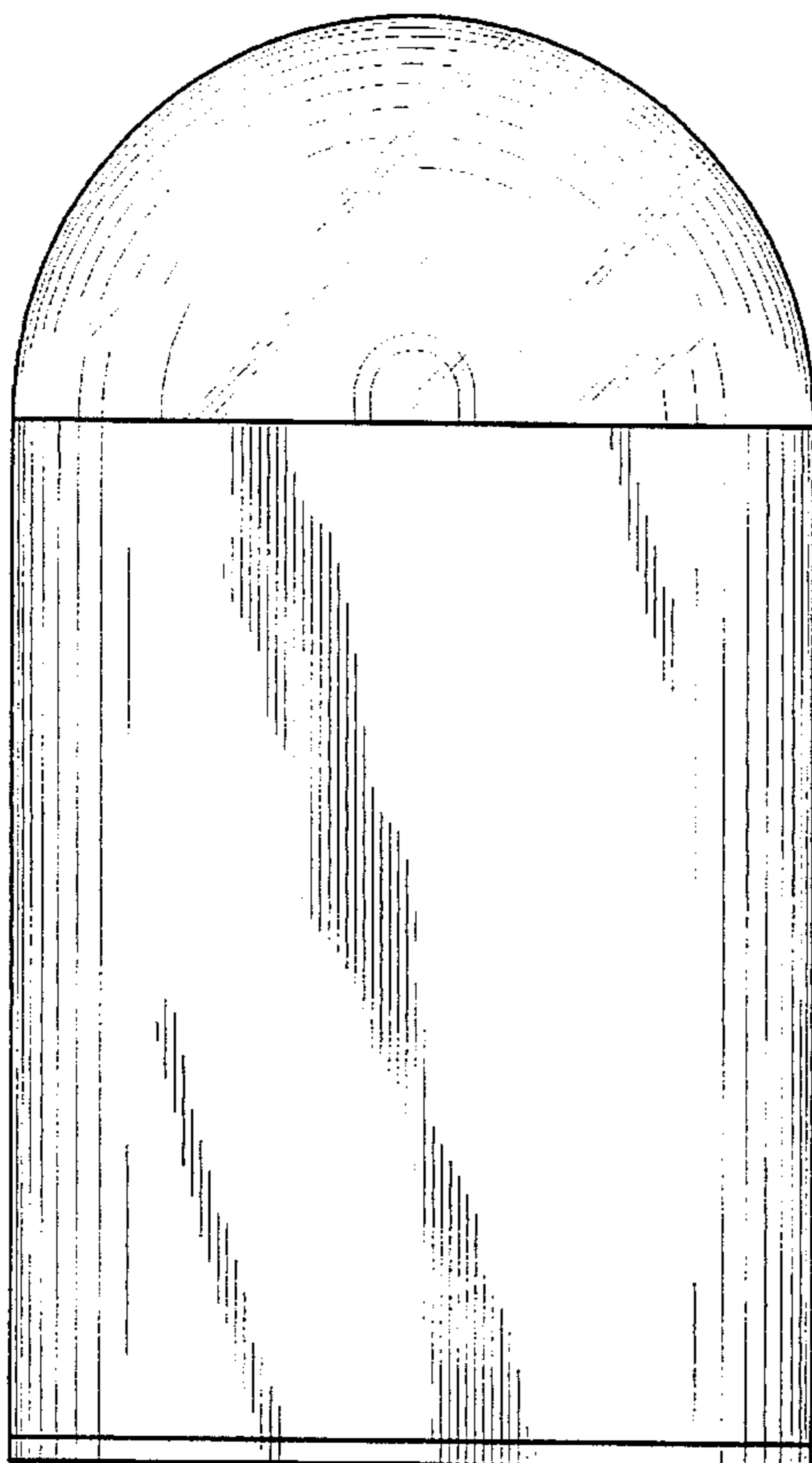

FIG. 2

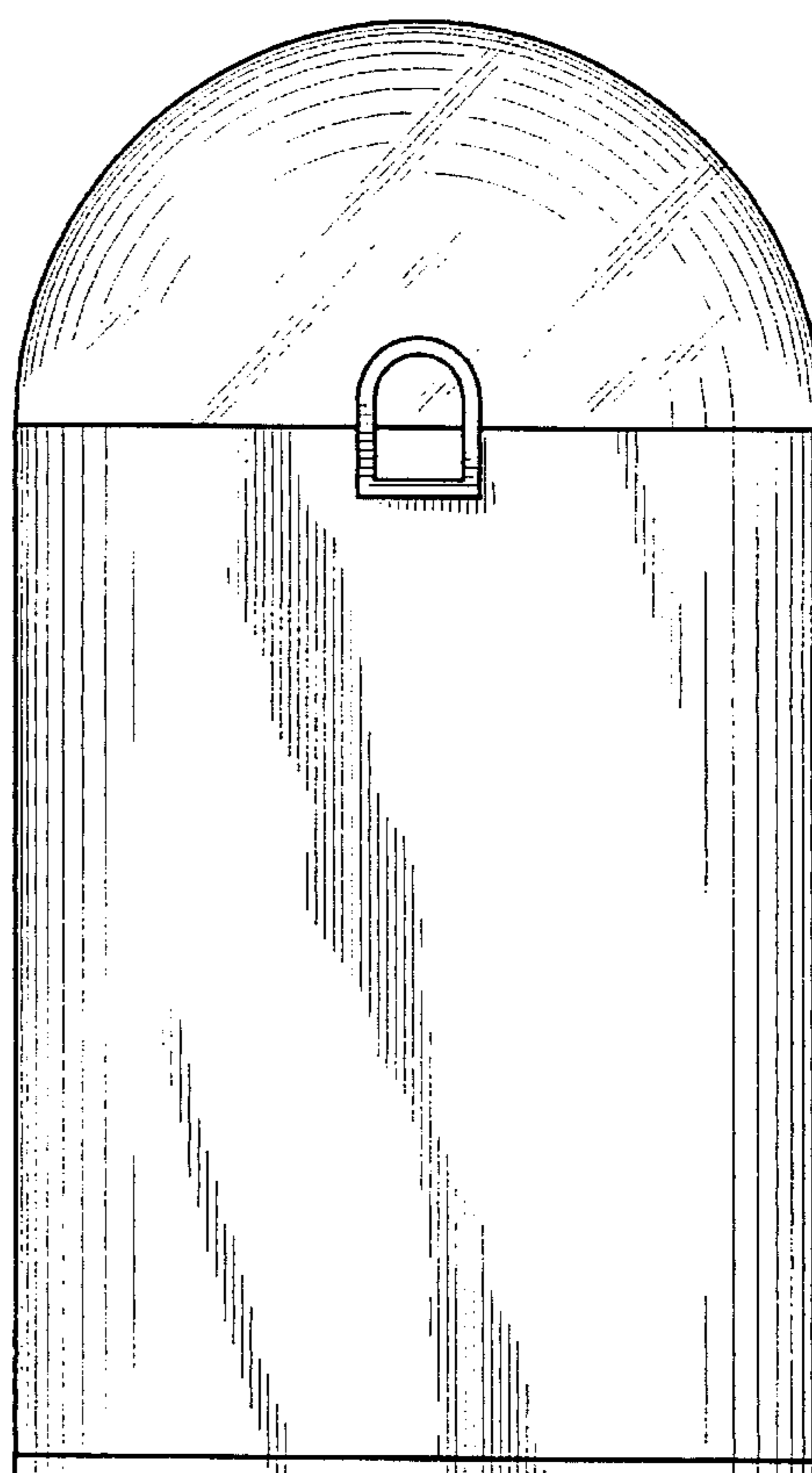

FIG. 3

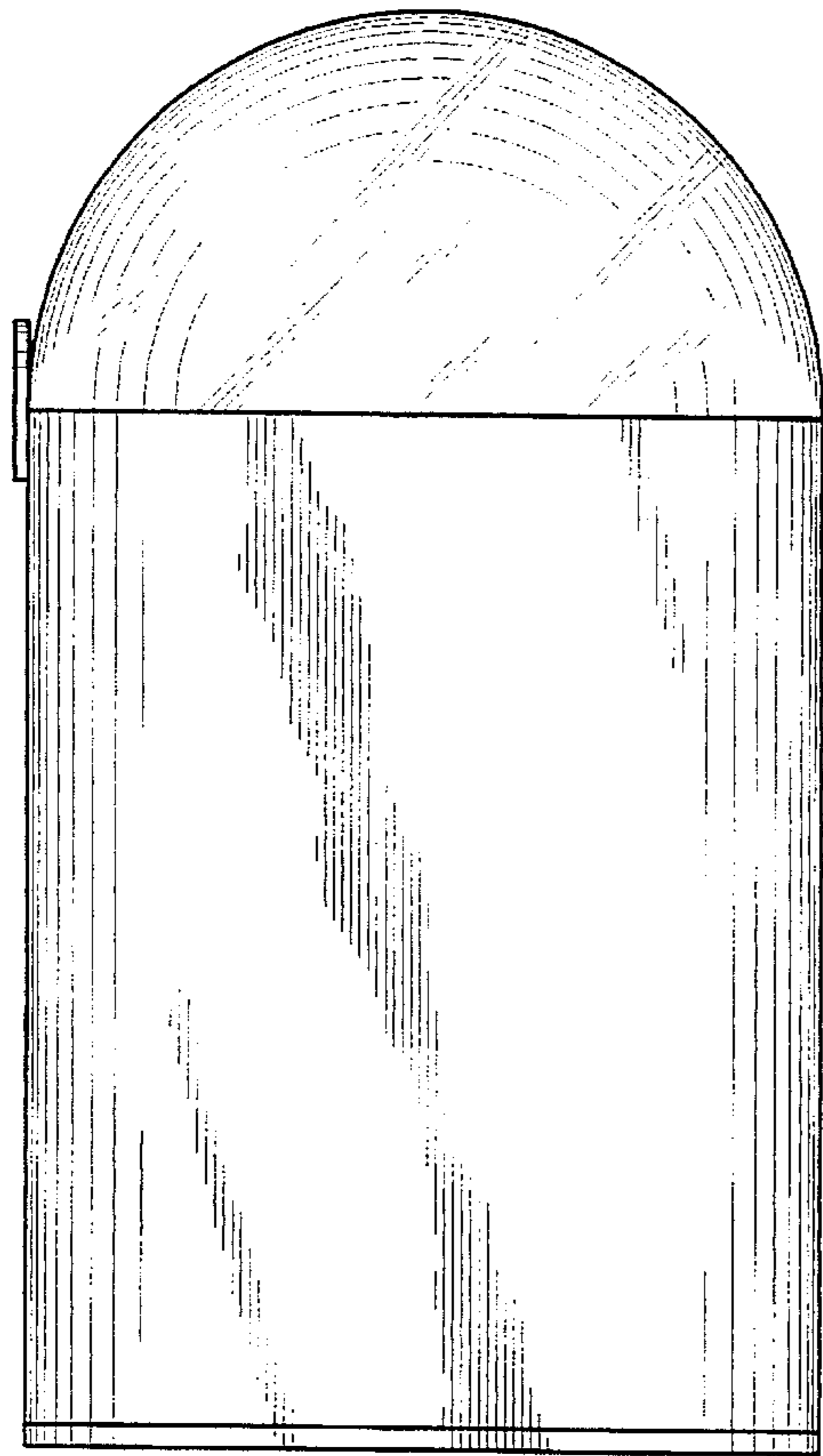

FIG. 4

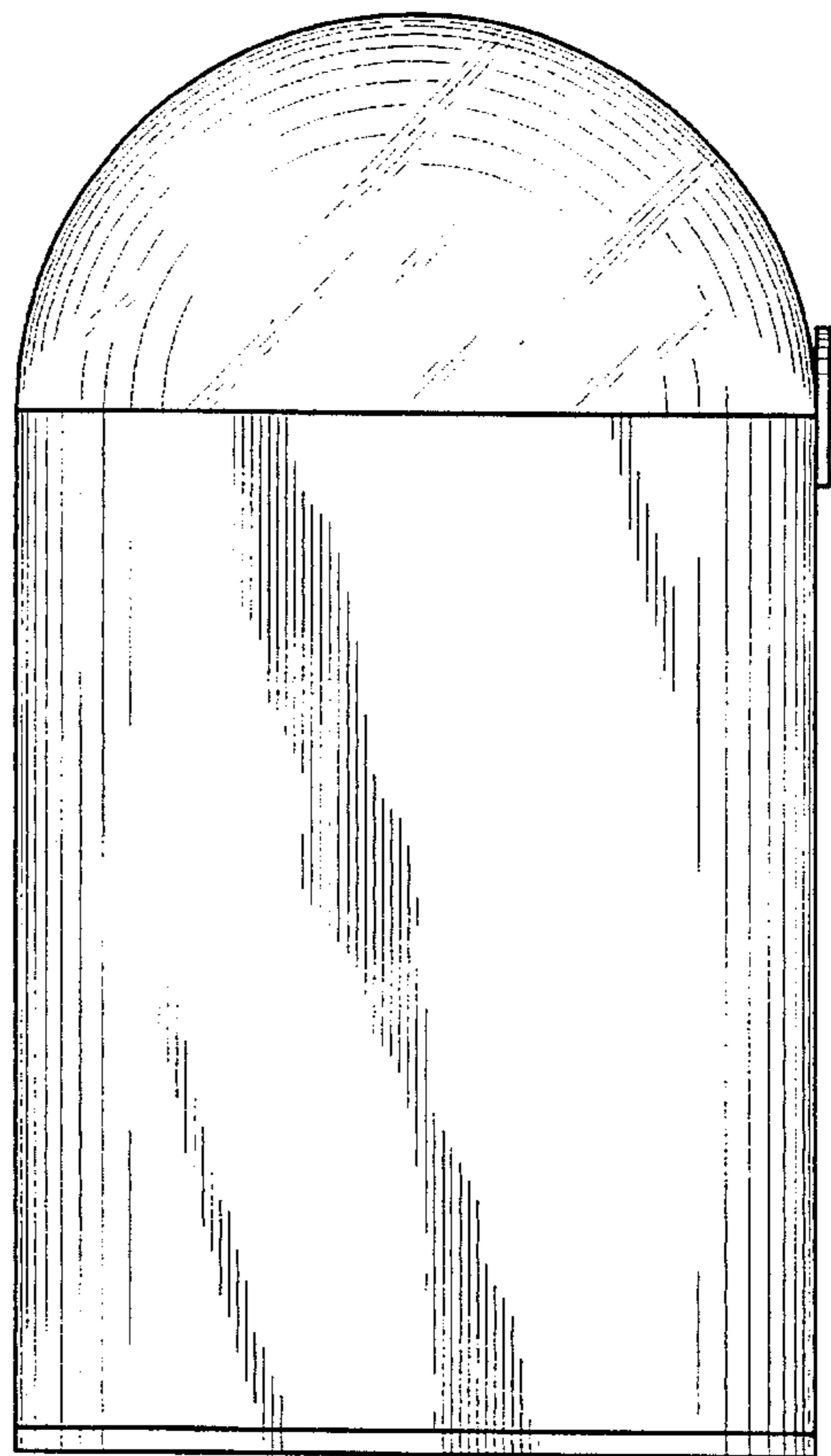

FIG. 5

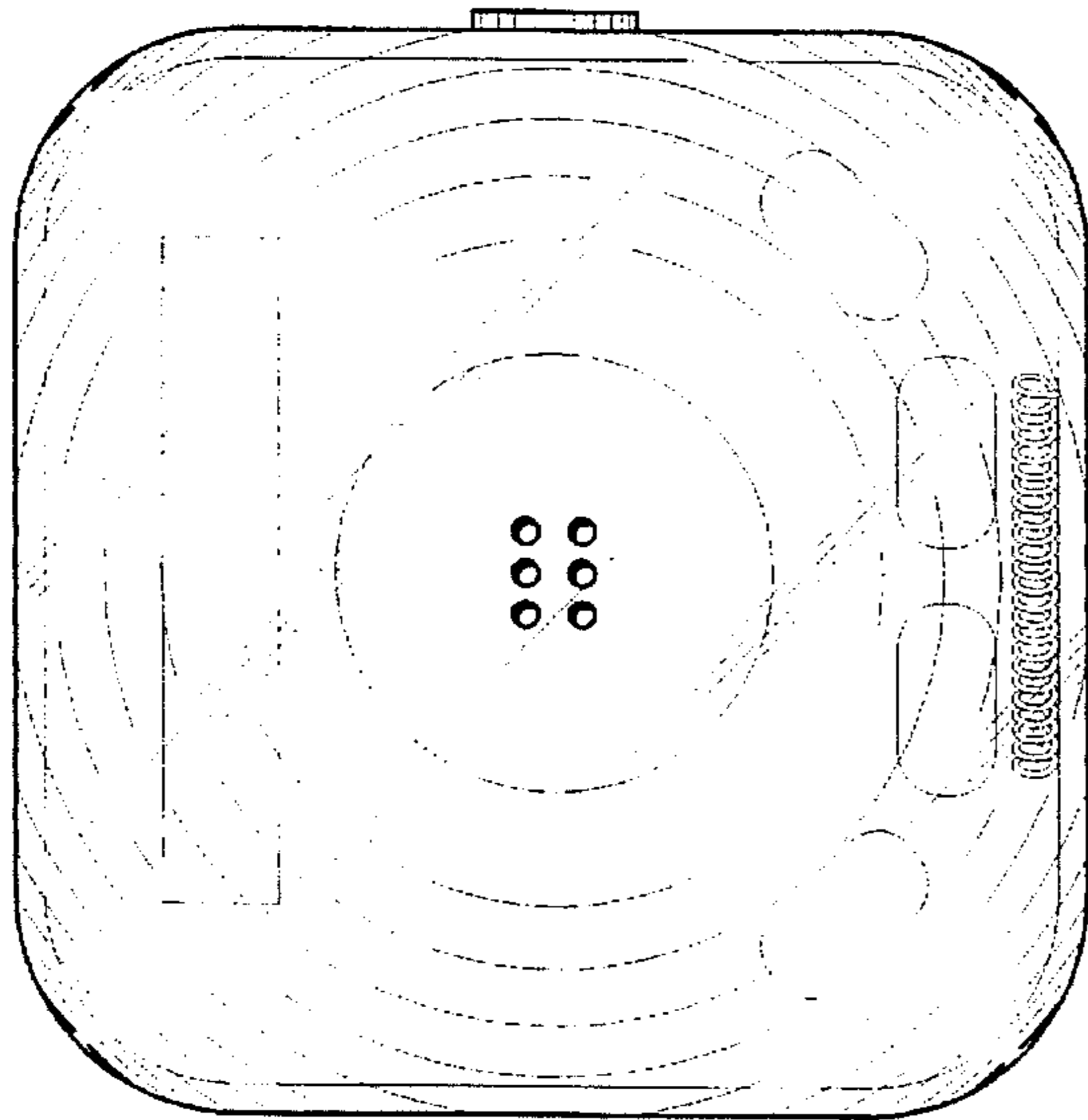

FIG. 6

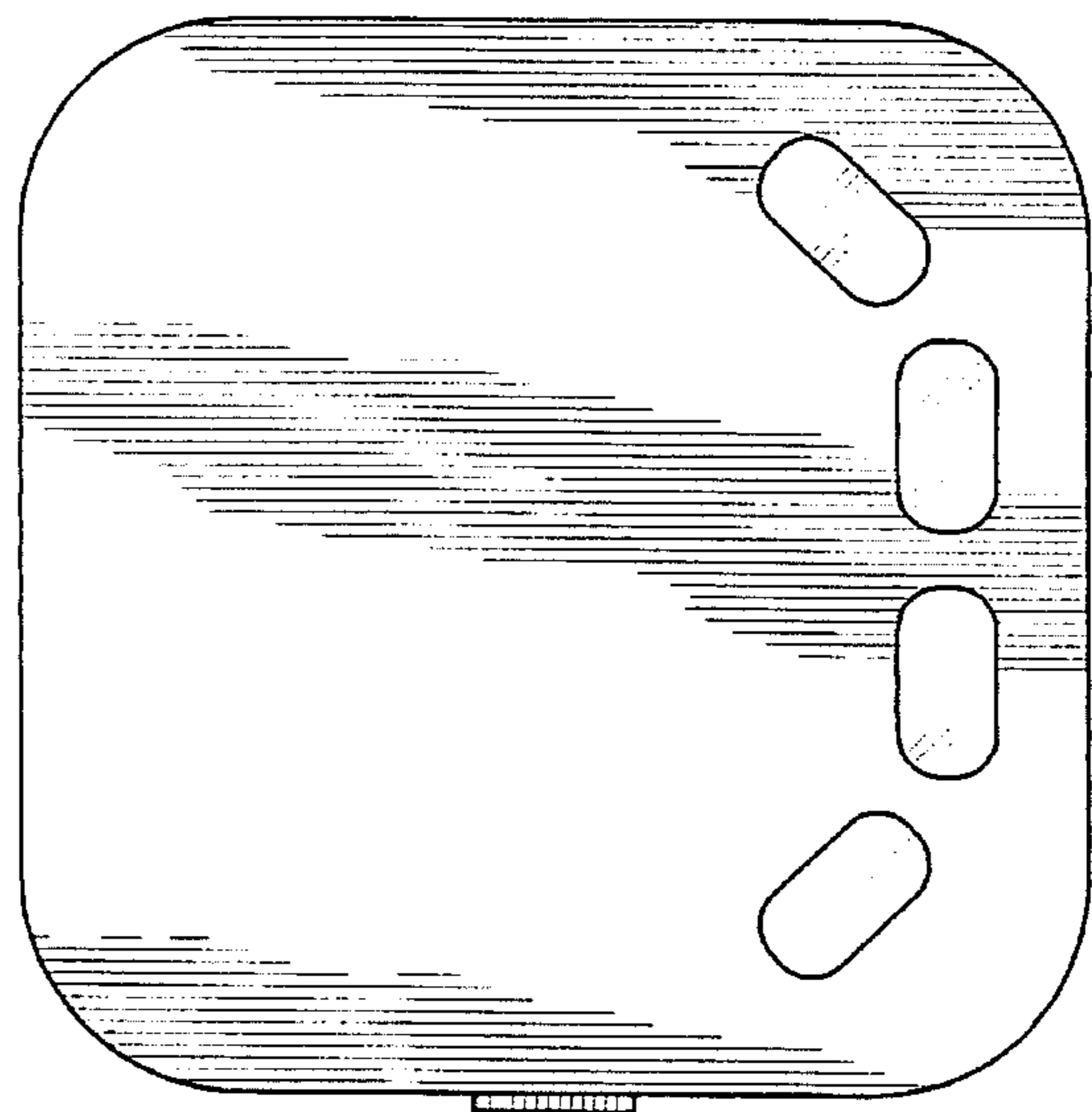

FIG. 7

