



US00D370745S

United States Patent [19] Madigan

[11] Patent Number: Des. 370,745

[45] Date of Patent: *** Jun. 11, 1996

[54] BIRD HOUSE

[76] Inventor: Brad A. Madigan, 6626 Hyslop Rd.,
Dane, Wis. 53529

[*] Notice: The portion of the term of this patent
subsequent to May 3, 2008, has been
disclaimed.

[**] Term: 14 Years

[21] Appl. No.: 22,284

[22] Filed: May 3, 1994

Related U.S. Application Data

[63] Continuation-in-part of Ser. No. 883,588, May 13, 1992,
Pat. No. 5,307,760.

[52] U.S. Cl. D30/110; D30/125

[58] Field of Search 119/72.5, 23, 57.8,
119/52.2, 51.01, 57.91, 51.04; D30/110-111,
124-128, 120-122, 132

[56] References Cited

U.S. PATENT DOCUMENTS

D. 173,294	10/1954	Voeks	D30/111
D. 251,021	2/1979	Blasbalg	D30/127
D. 268,619	4/1983	Blasbalg	D30/128
D. 269,300	6/1983	Blasbalg	D30/128
D. 281,026	10/1985	Burke et al.	D30/128
D. 349,982	8/1994	Hardison	D30/128
1,112,068	9/1914	Keller	119/70
1,199,655	9/1916	Battle	119/54
1,217,438	2/1917	Gallagher	119/70
1,253,002	1/1918	Collins	119/70
1,367,971	2/1921	Hunnicutt	119/53.5
1,894,406	1/1933	Lenhart	D30/110
2,277,420	3/1942	Stanfield	119/51
2,972,334	2/1961	Braden	119/51
3,040,705	6/1962	Schlitz	119/51
3,515,098	6/1970	Thurmond	119/51
3,568,641	3/1971	Kilham	119/51
3,677,230	7/1972	Braden	119/51
3,730,142	5/1973	Kahrs et al.	119/54

3,741,163	6/1973	Bush	119/54
3,780,701	12/1973	Wentworth, Sr.	119/51.01
4,102,308	7/1978	Kilham	119/52.3
4,270,489	6/1981	Joronon	119/51.04
4,355,597	10/1982	Blasbalg	119/57.8
4,356,793	11/1982	Blasbalg	119/47.9
4,712,512	12/1987	Schreib et al.	119/52.2
4,829,934	5/1989	Blasbalg	119/57.8
4,945,859	8/1990	Churchwell	119/57.91
4,974,547	12/1990	Graham	119/52.2
5,063,877	11/1991	Riggi	119/52.2
5,085,173	2/1992	Powers	119/53.5

FOREIGN PATENT DOCUMENTS

3340244	5/1985	Germany	119/52.2
---------	--------	---------	----------

OTHER PUBLICATIONS

Newsweek; Oct. 18, 1993; p. 29; Advertisement by Qantas, Australian Airline for a Feeder.
Home Furnishings Daily; Feb. 4, 1965; p. 23; West Bend Comp. advertisement for Bird Feeder.
House & Garden; Oct. 1957; p. 190; Bird House.
The Delta Project; May/June 1957; p. 46; Nail Keg Martin House.

Primary Examiner—Cathy Anne MacCormac
Attorney, Agent, or Firm—Teresa J. Welch; Stroud, Stroud, Willink, Thompson & Howard

[57] CLAIM

The ornamental design for a bird house, as shown and described herein.

DESCRIPTION

FIG. 1 is a perspective view showing the new design;
FIG. 2 is a right side elevational view thereof;
FIG. 3 is a left side elevational view thereof;
FIG. 4 is a top plan view thereof;
FIG. 5 is a bottom plan view thereof;
FIG. 6 is a front elevational view thereof; and,
FIG. 7 is a back elevational view thereof.

1 Claim, 2 Drawing Sheets

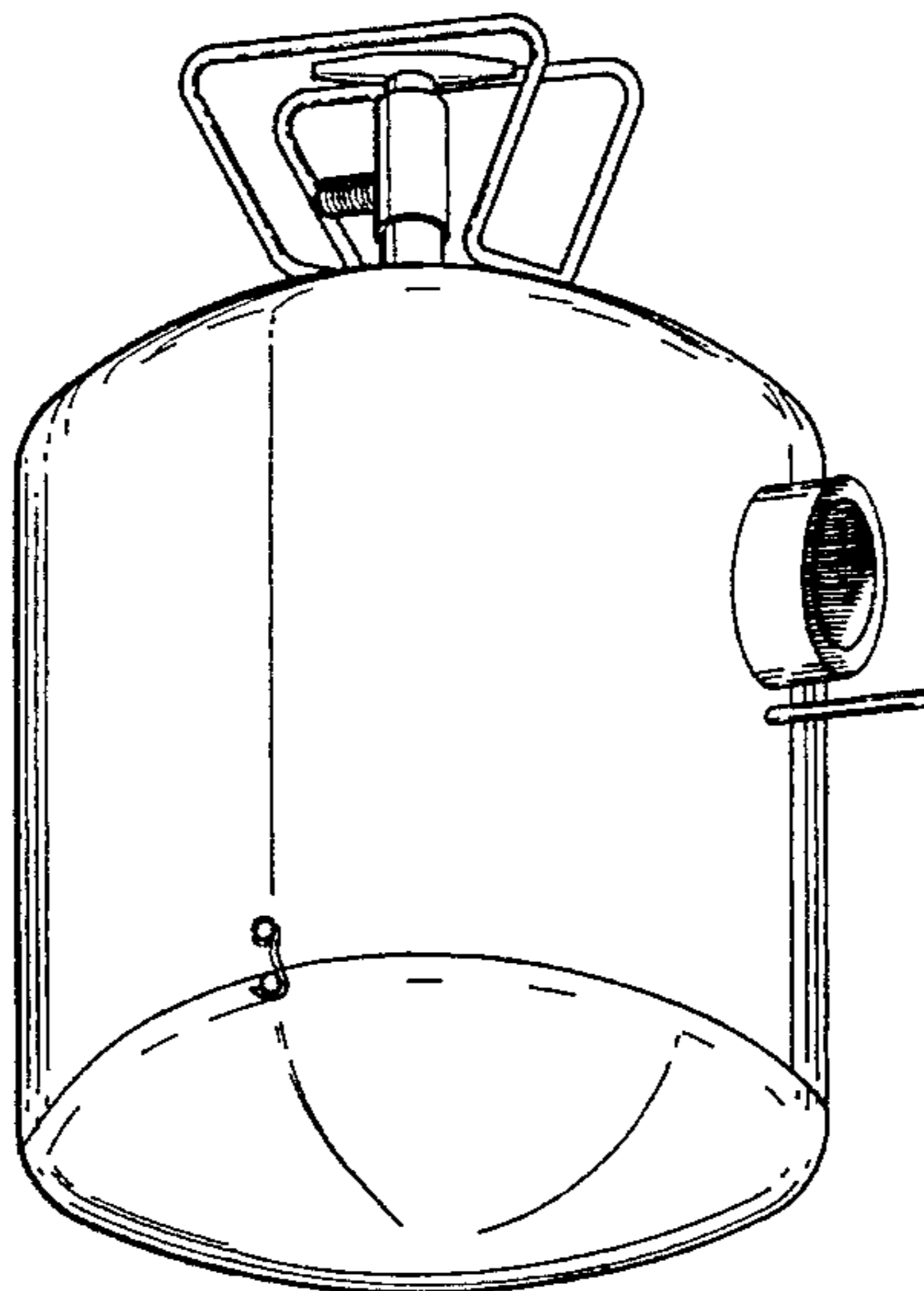

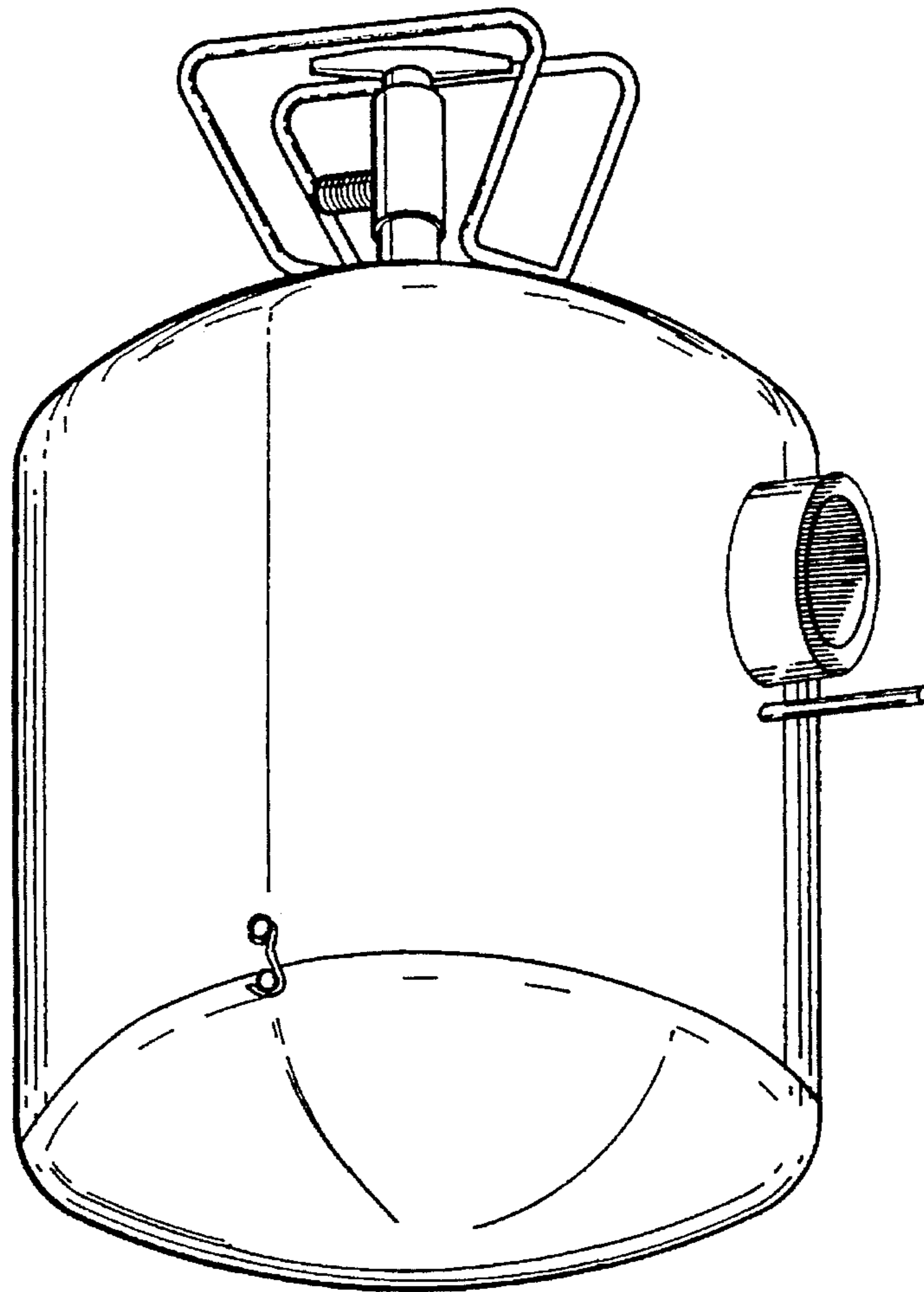

FIG. 1

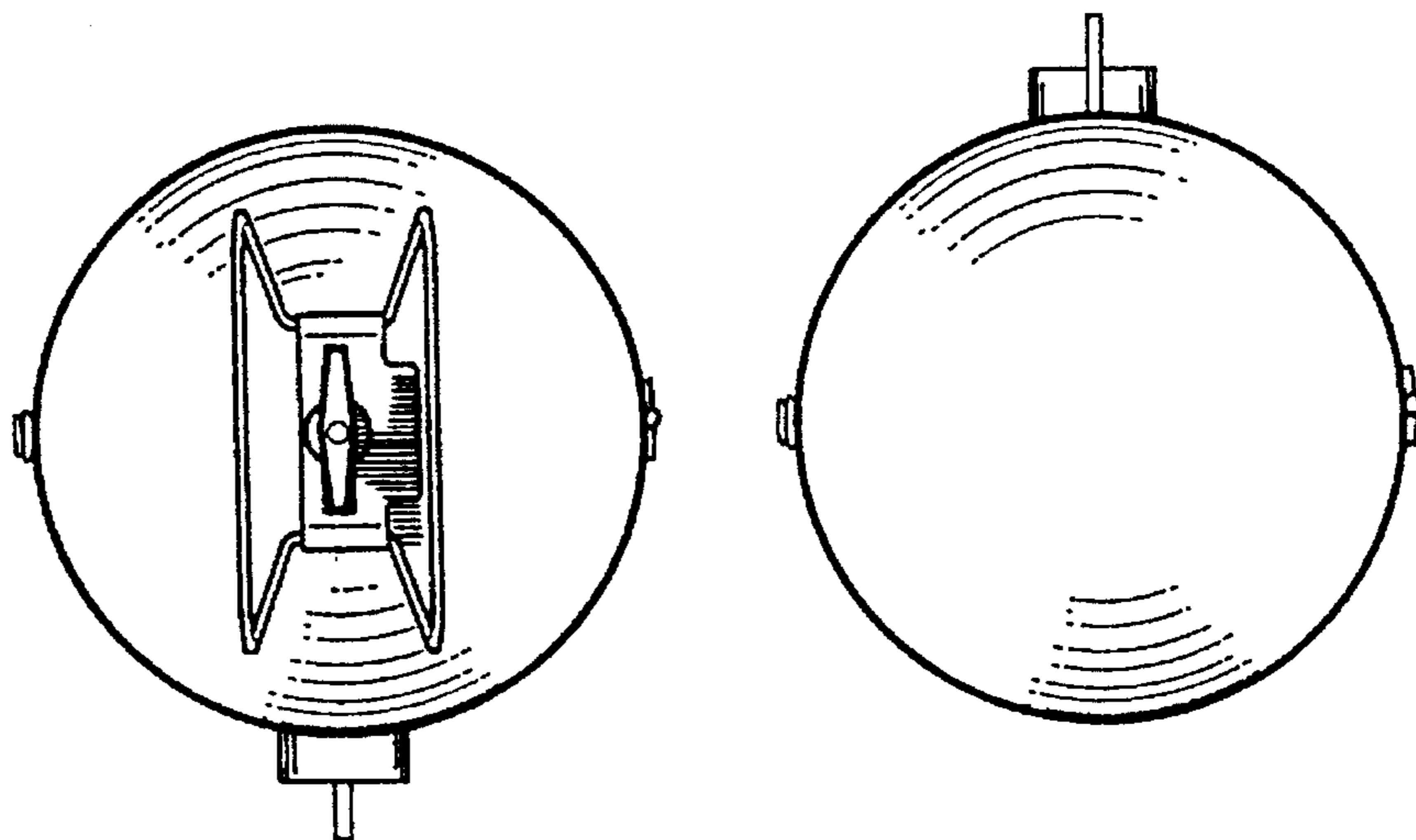

FIG. 4

FIG. 5

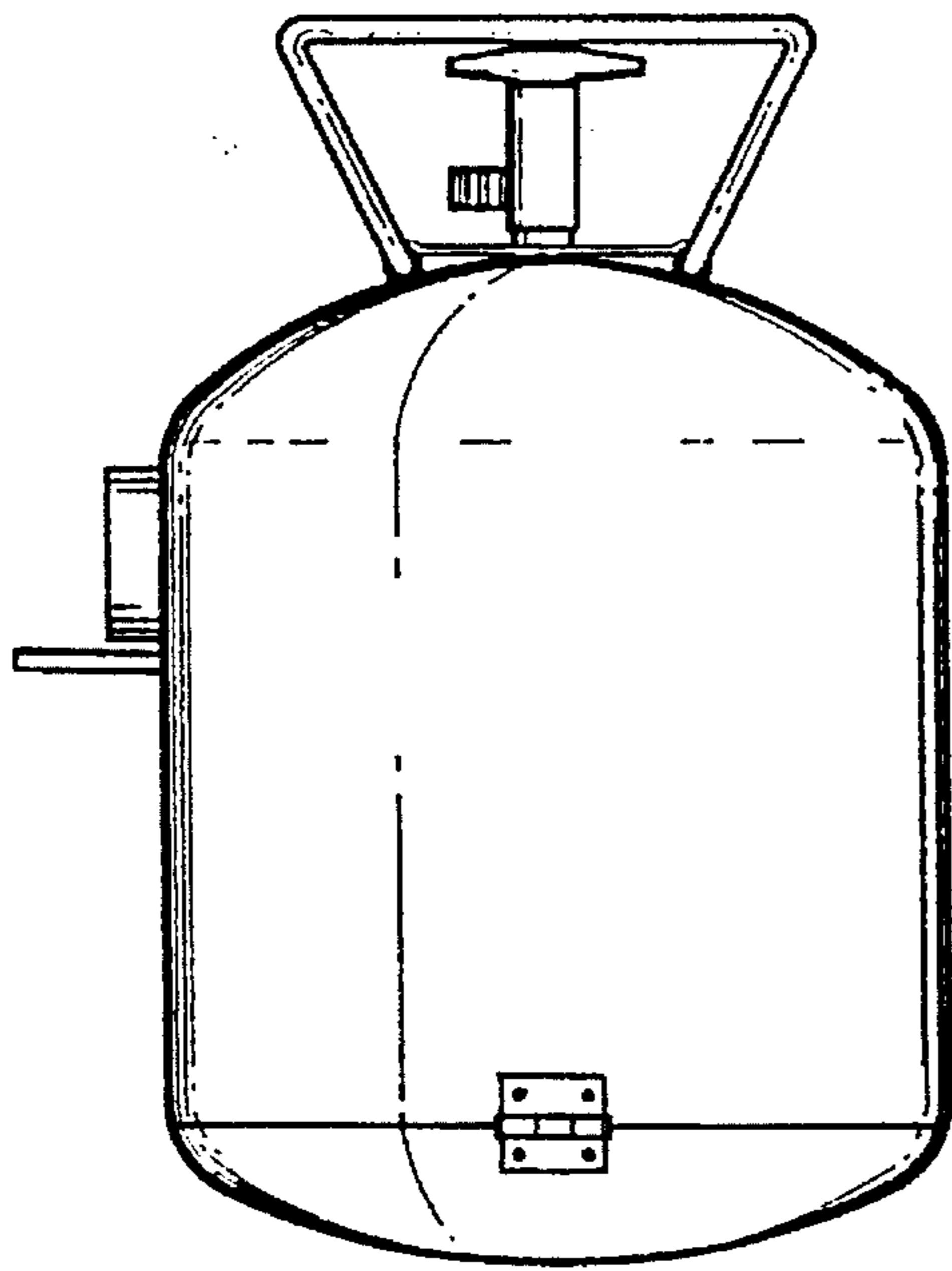

FIG. 2

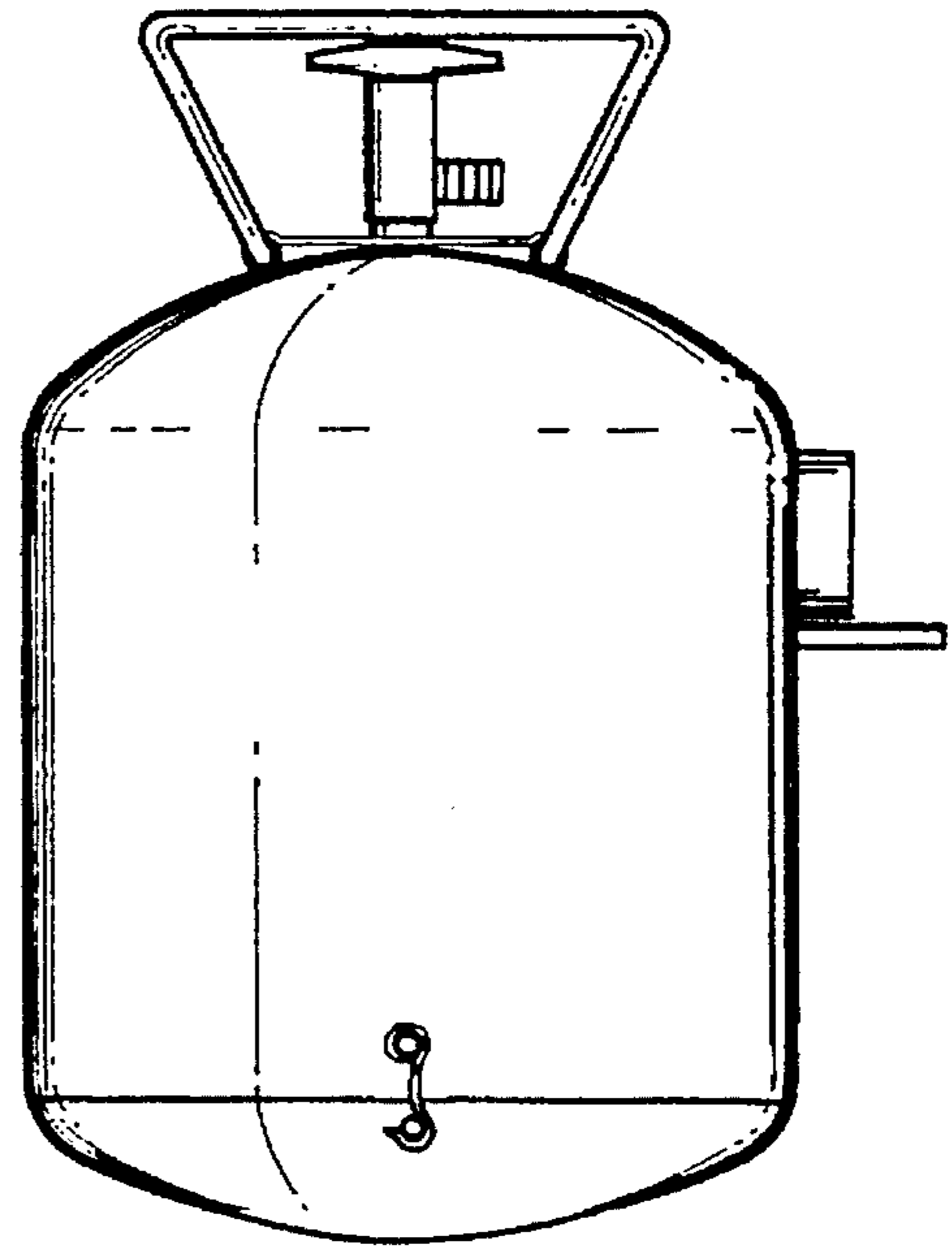

FIG. 3

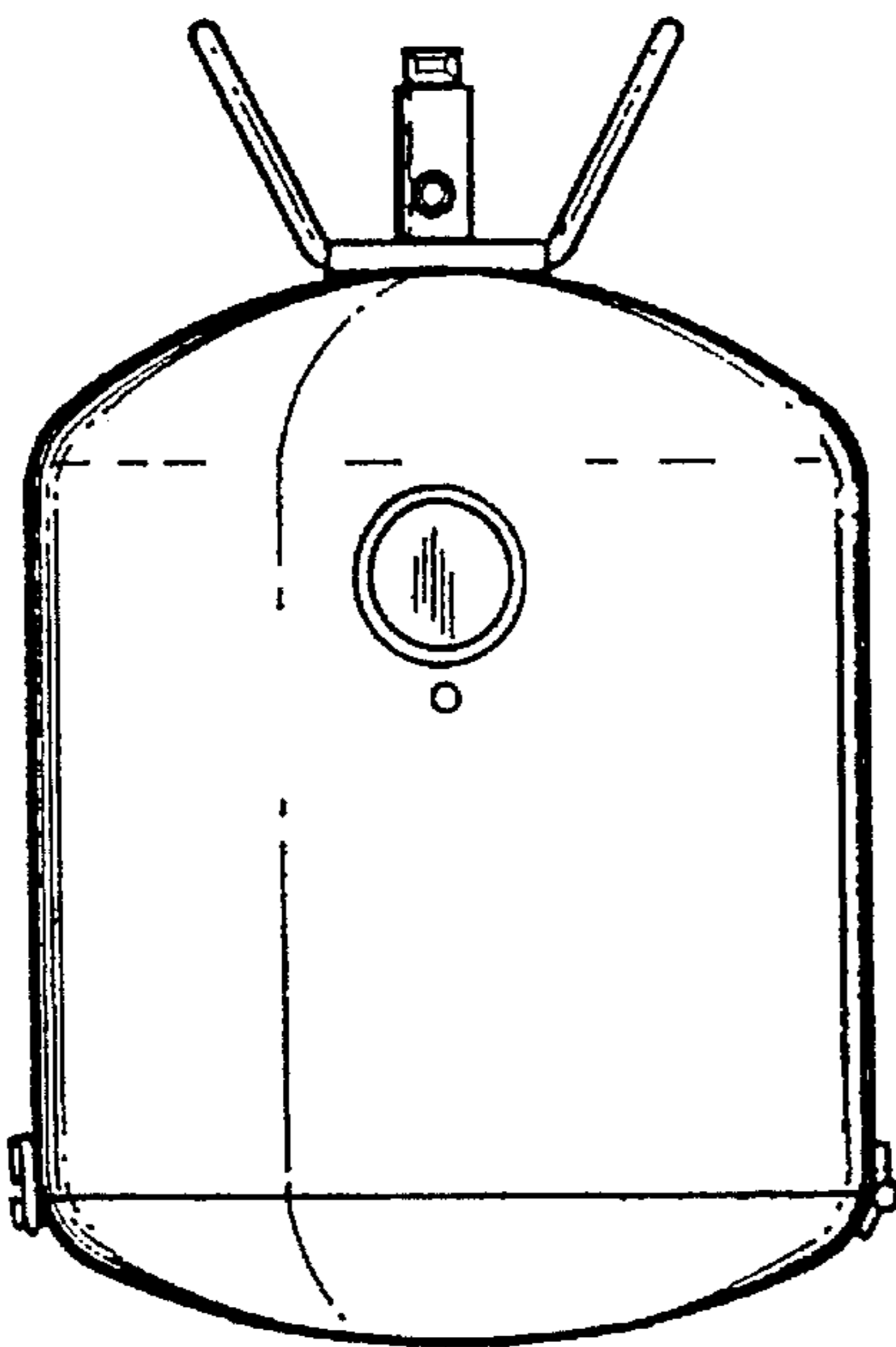

FIG. 6

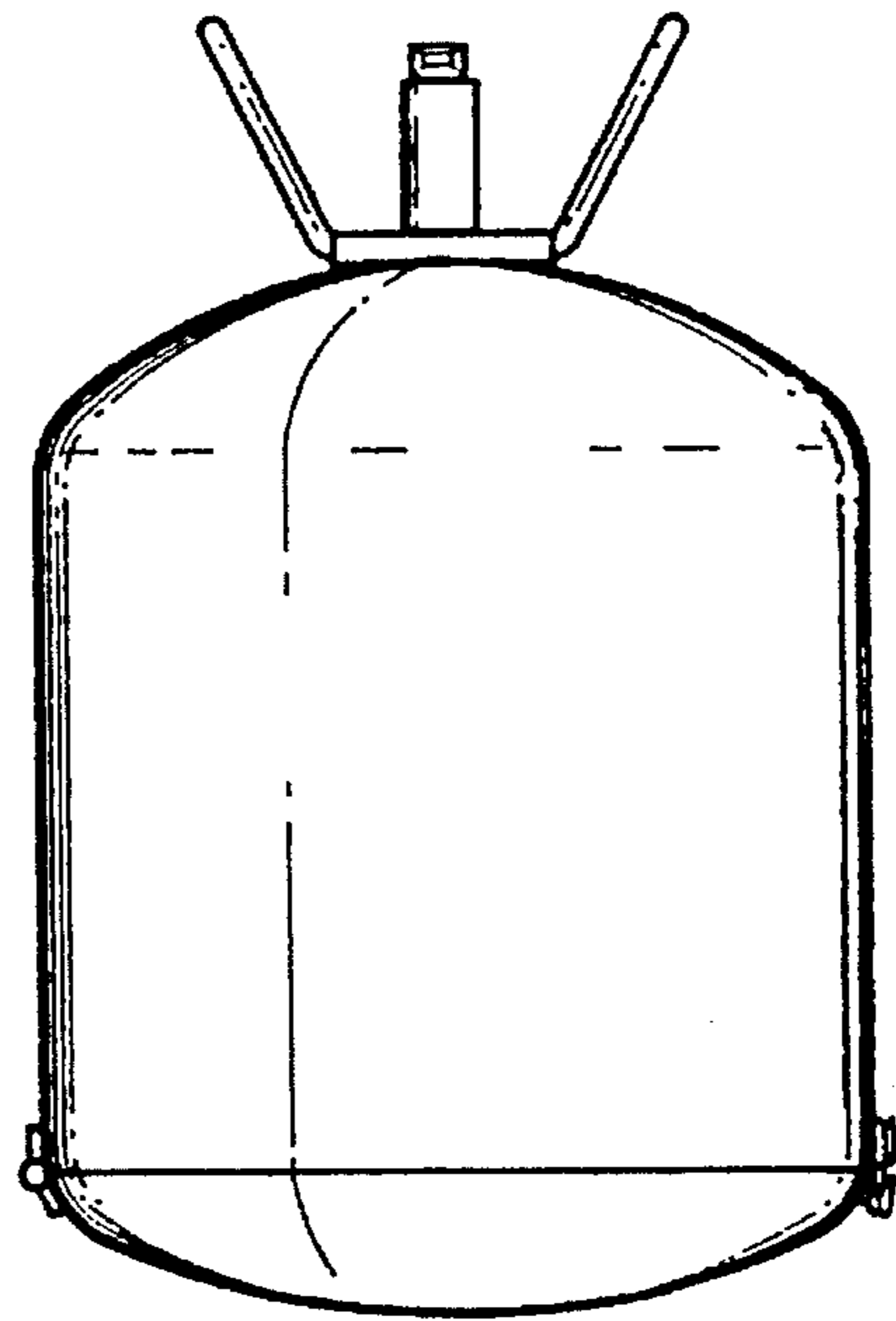

FIG. 7