



US00D370733S

# United States Patent [19]

Lechleiter et al.

[11] Patent Number: **Des. 370,733**

[45] Date of Patent: **\*\*Jun. 11, 1996**

[54] STORE CENTER

3,906,215 9/1975 Dinicola ..... D11/157 X

[75] Inventors: **Paul R. Lechleiter, Powell; Mark B. Artus, Beechwold, both of Ohio**

*Primary Examiner*—Louis S. Zarfes

*Assistant Examiner*—Monica A. Hannon

*Attorney, Agent, or Firm*—Akin, Gump, Strauss, Hauer & Feld

[73] Assignee: **Blockbuster Entertainment Corporation, Ft. Lauderdale, Fla.**

### [57] CLAIM

[\*\*] Term: **14 Years**

The ornamental design for a store center, as shown and described.

[21] Appl. No.: **27,746**

### DESCRIPTION

[22] Filed: **Aug. 29, 1994**

[52] U.S. Cl. .... **D25/56; D25/31; D25/1**

[58] Field of Search ..... **D25/1, 2, 3, 5, D25/18, 19, 20, 21, 31, 32, 33, 56; D6/396, 421; D11/157**

FIG. 1 is a front perspective view of a store center showing our new design;

FIG. 2 is a right side perspective view thereof;

FIG. 3 is a left side perspective view thereof;

FIG. 4 is a rear perspective view thereof;

FIG. 5 is a front view thereof;

FIG. 6 is a right side view thereof;

FIG. 7 is a left side view thereof;

FIG. 8 is a rear view thereof;

FIG. 9 is a bottom view thereof; and,

FIG. 10 is a top view thereof.

### [56] References Cited

#### U.S. PATENT DOCUMENTS

D. 107,425	12/1937	Harrison et al. ....	D25/3
D. 187,184	2/1960	Tangney .....	D11/157 X
D. 246,468	11/1977	Dipasqua .....	D25/1 X
D. 252,414	7/1979	Camara .....	D11/157 X
D. 326,873	6/1992	Chang .....	D11/157 X

**1 Claim, 10 Drawing Sheets**

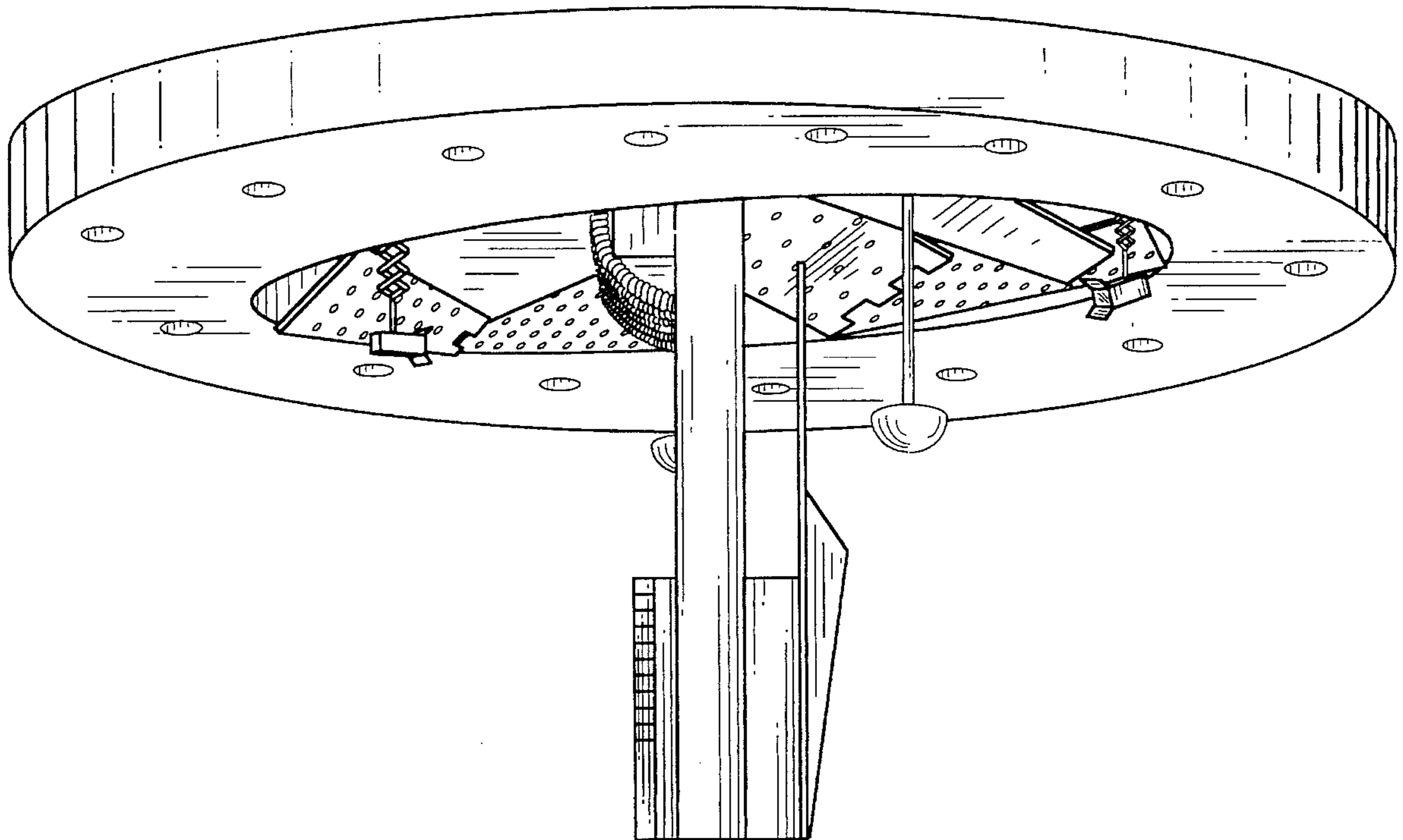

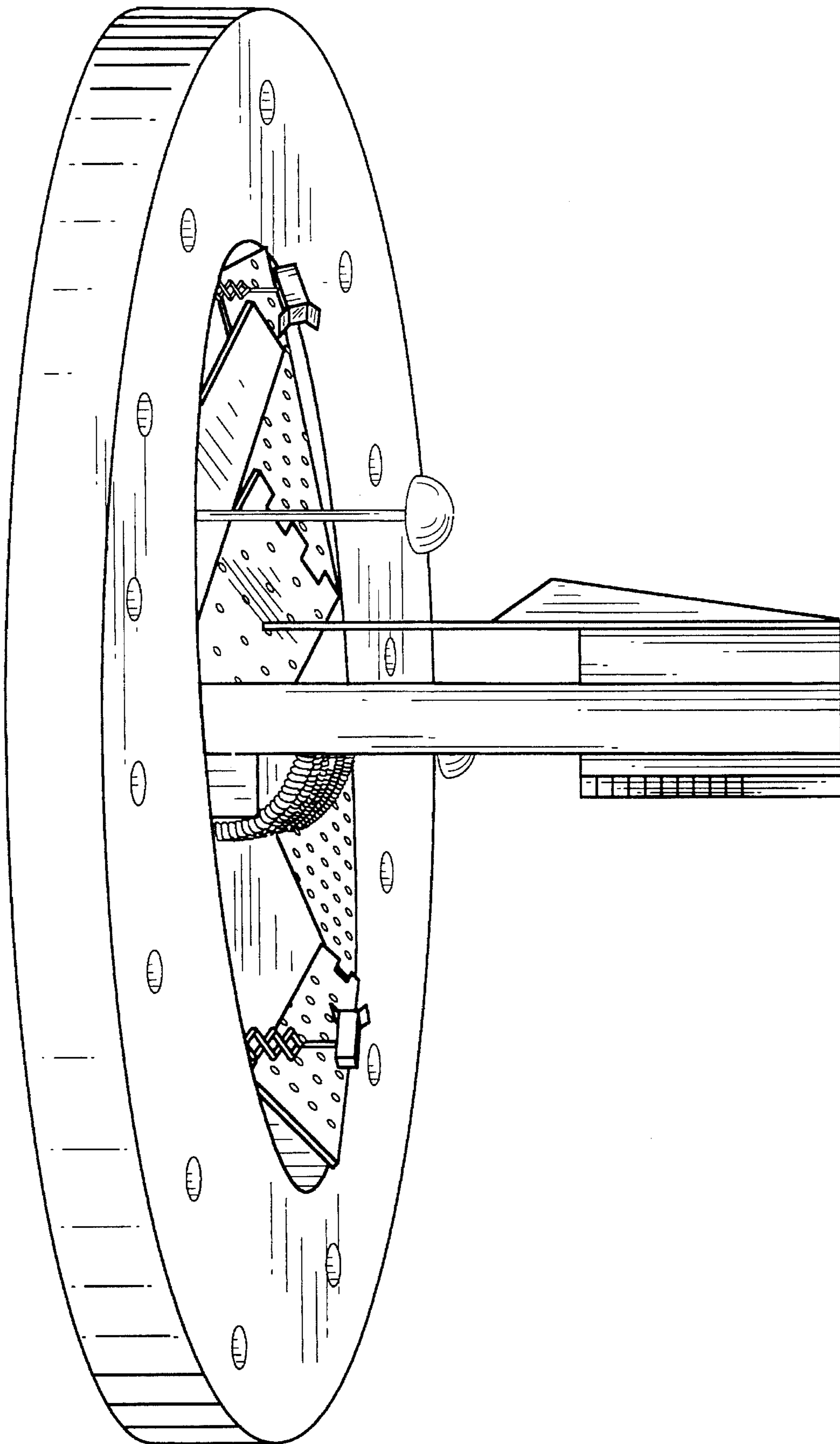

Fig. 1

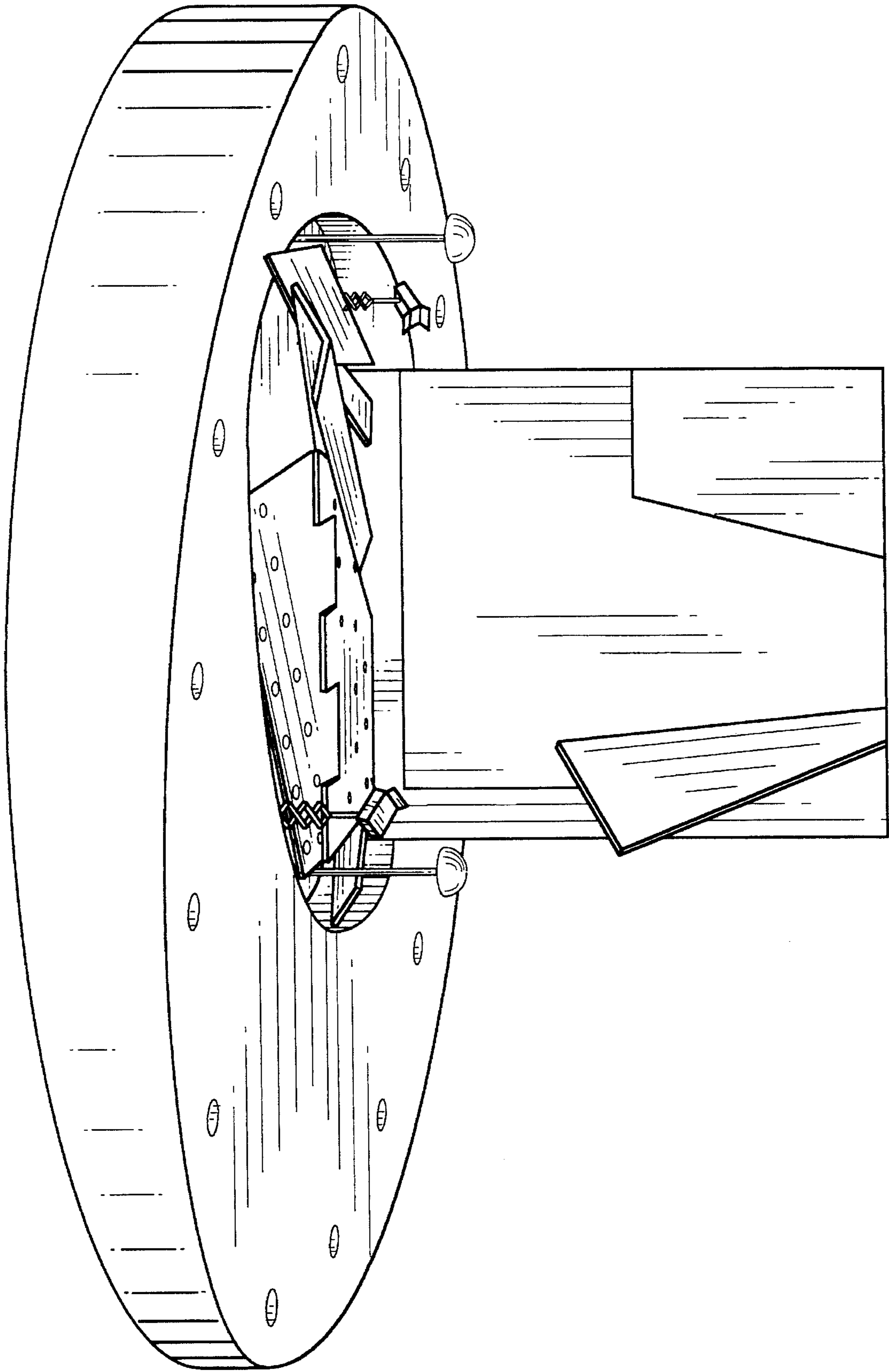

Fig. 2

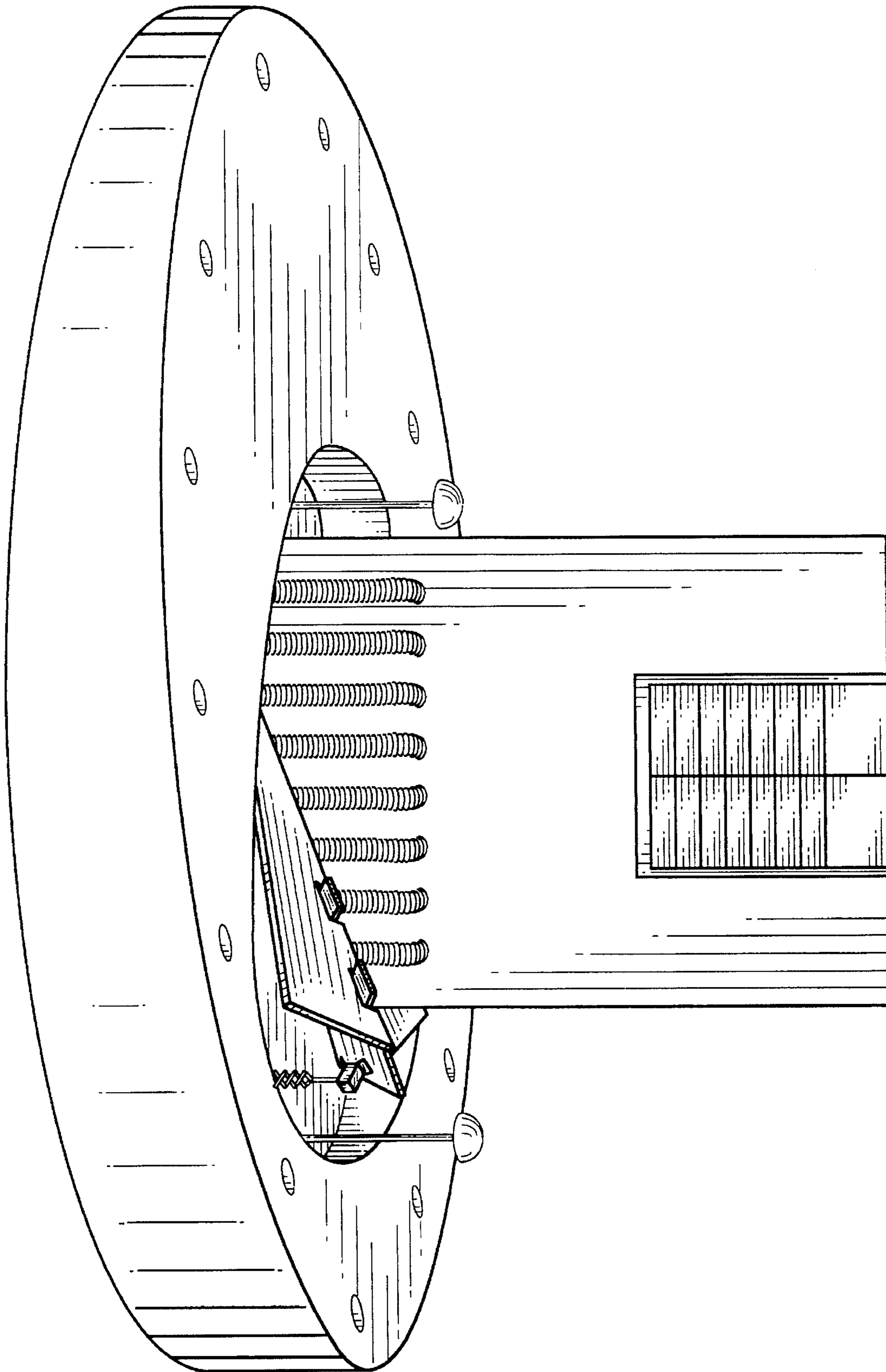

Fig. 3

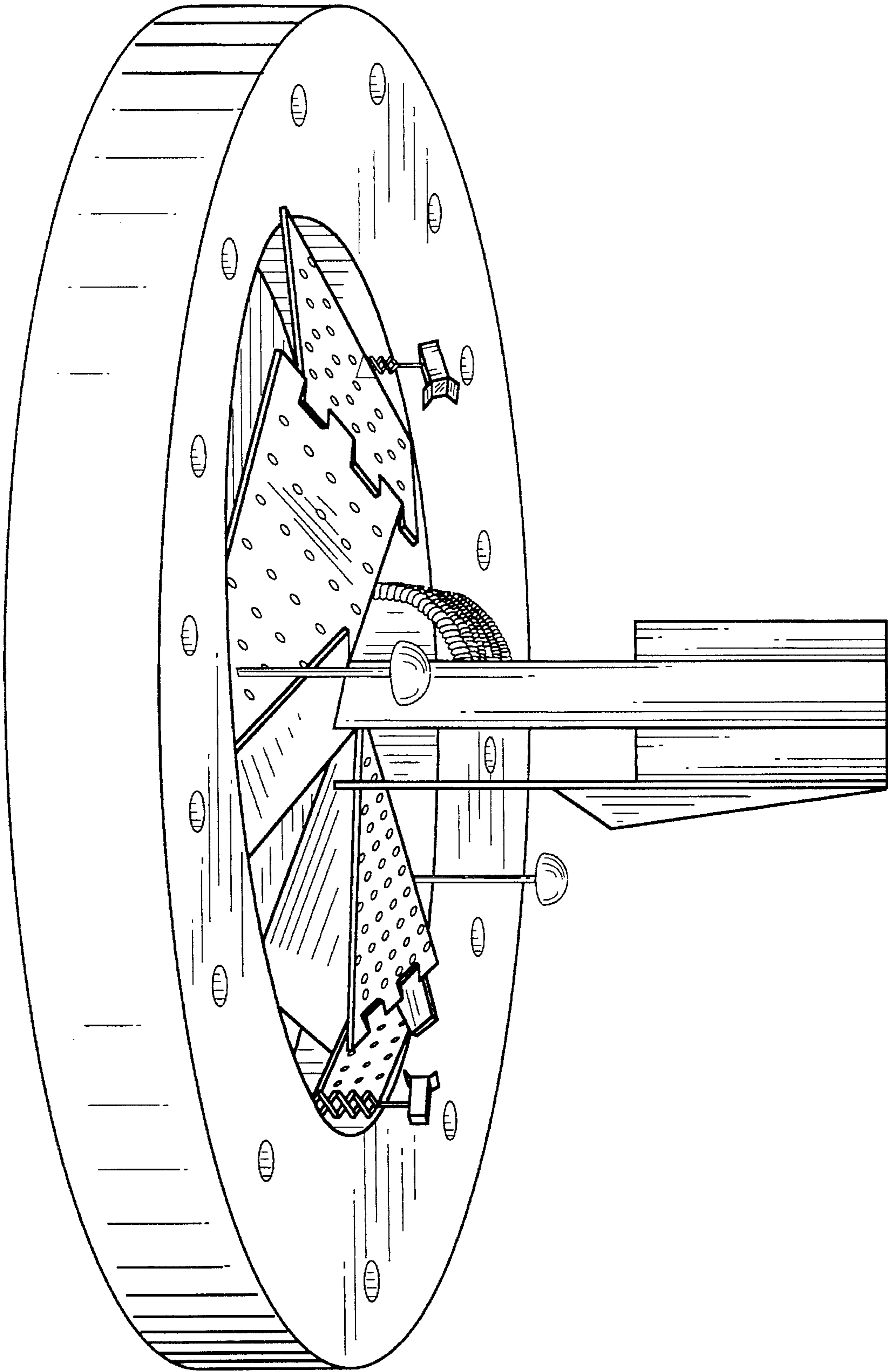

Fig. 4

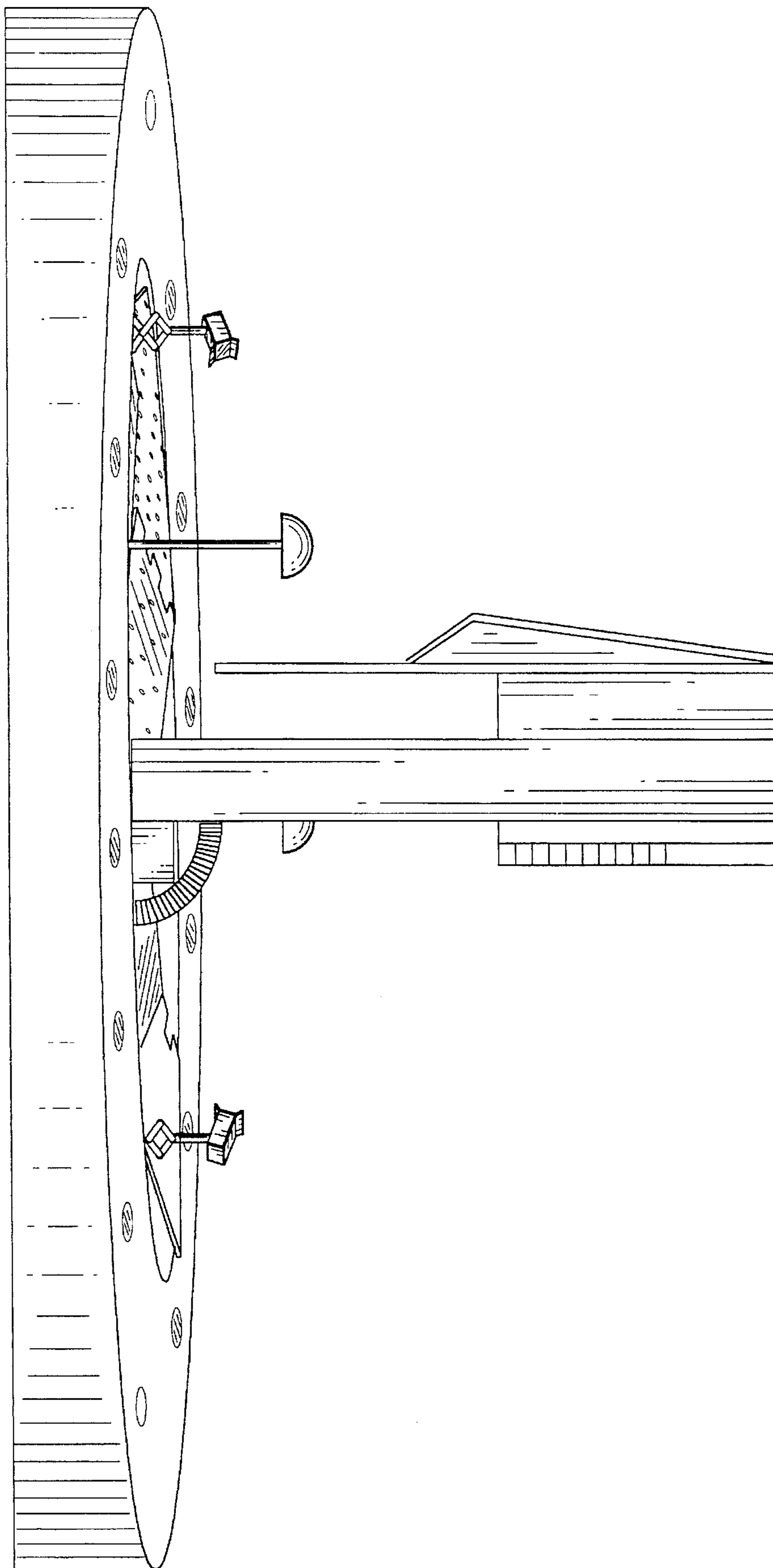

Fig. 5

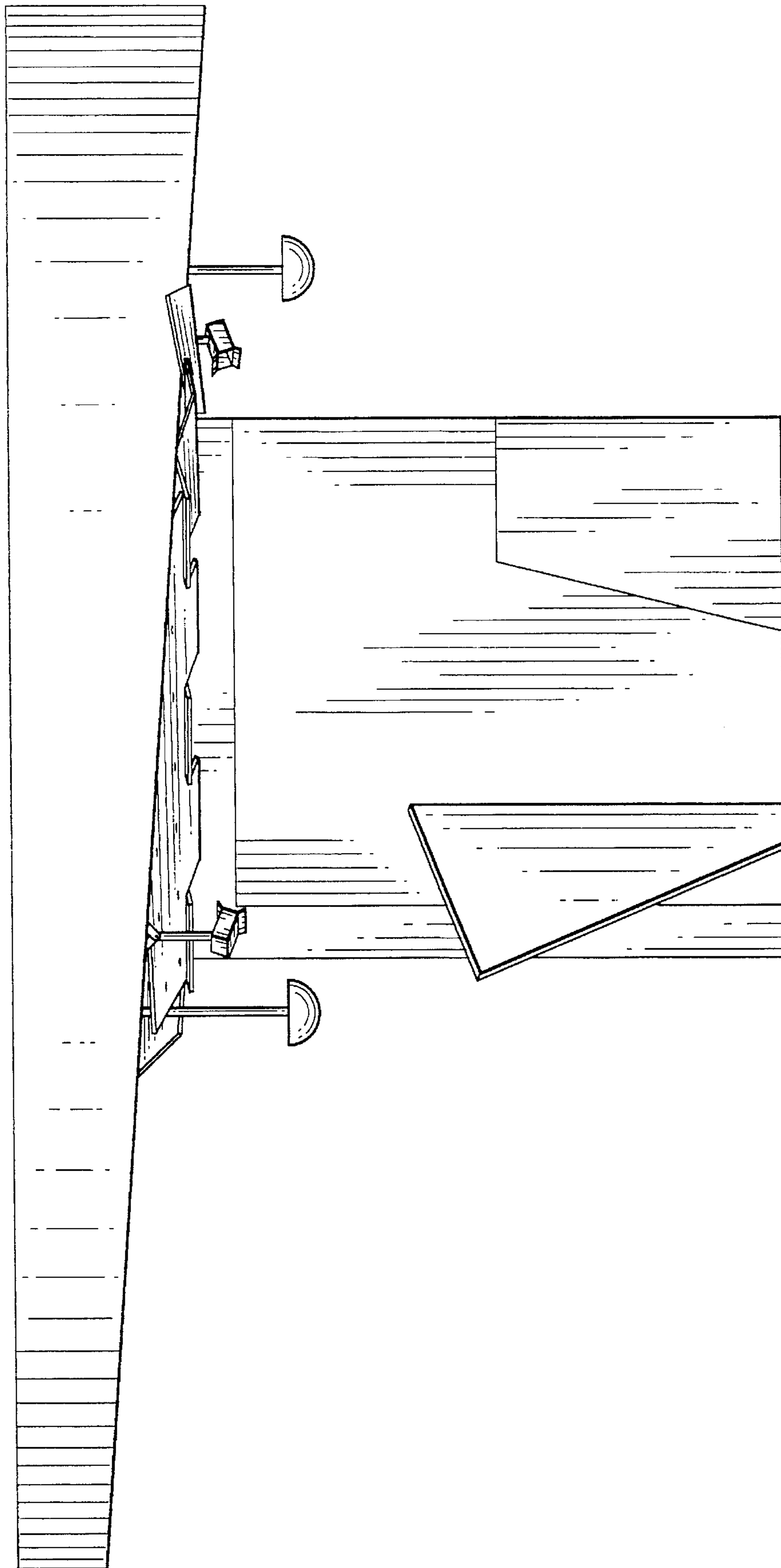

Fig. 6

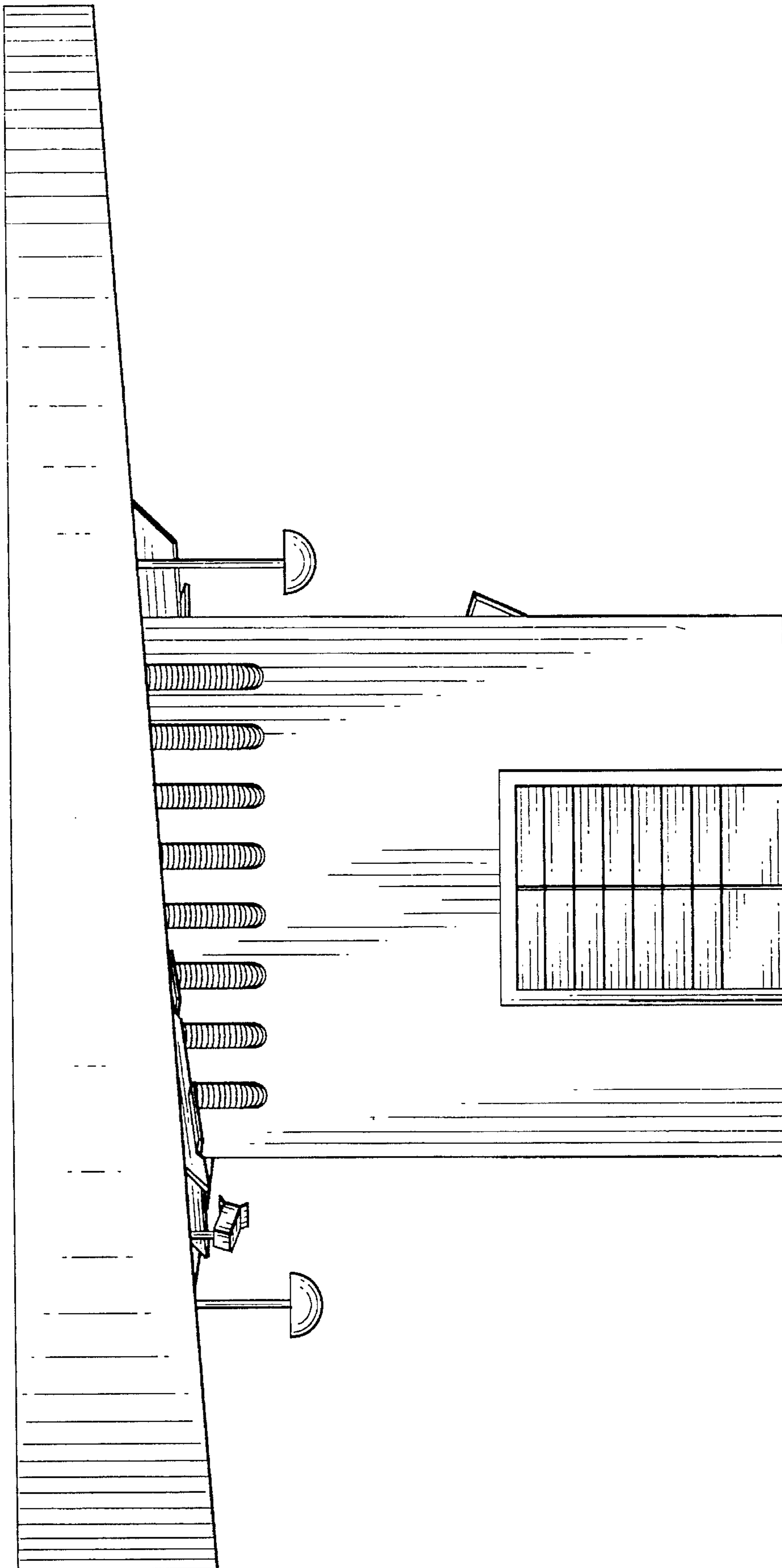

Fig. 7



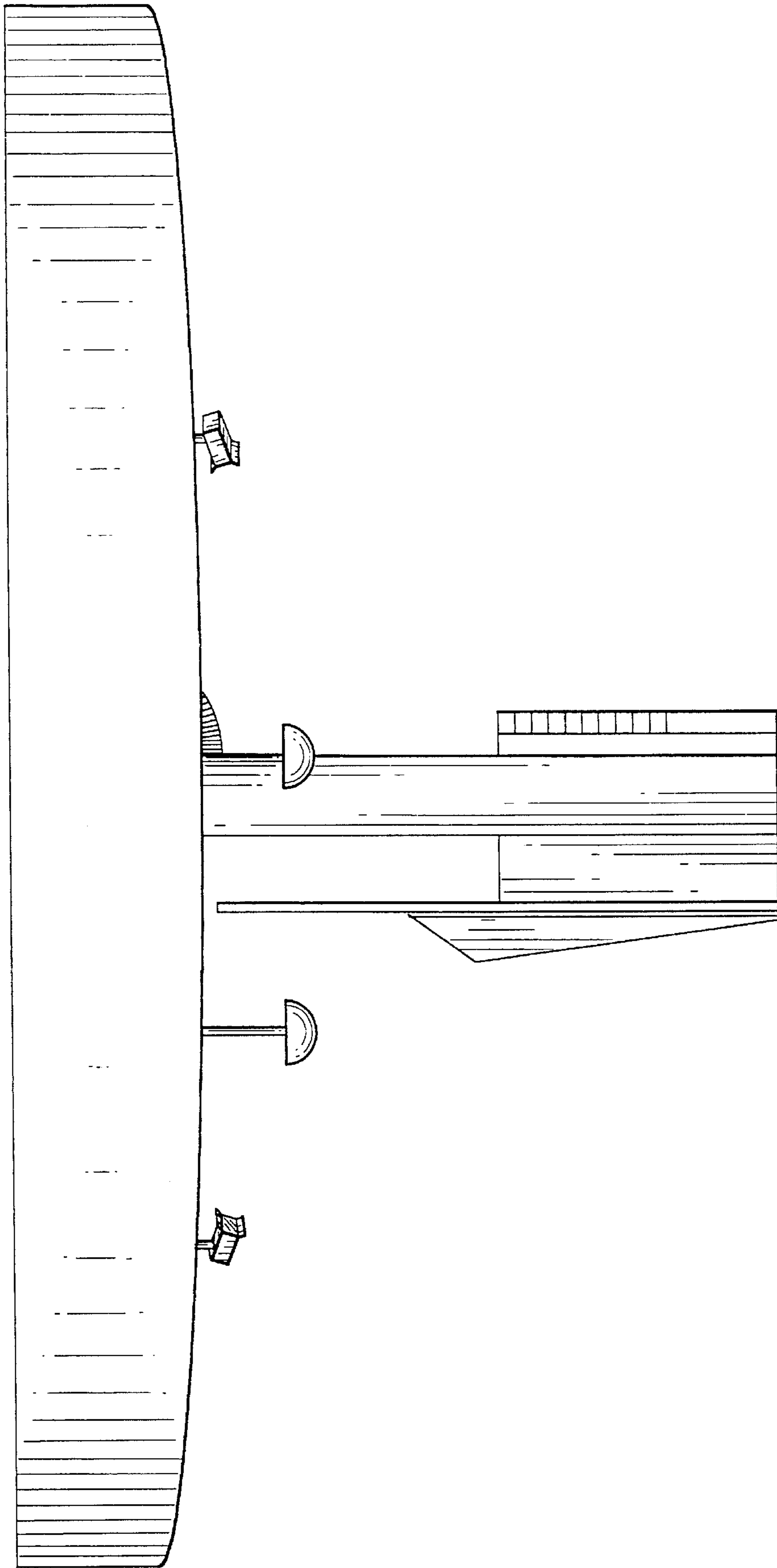

Fig. 8

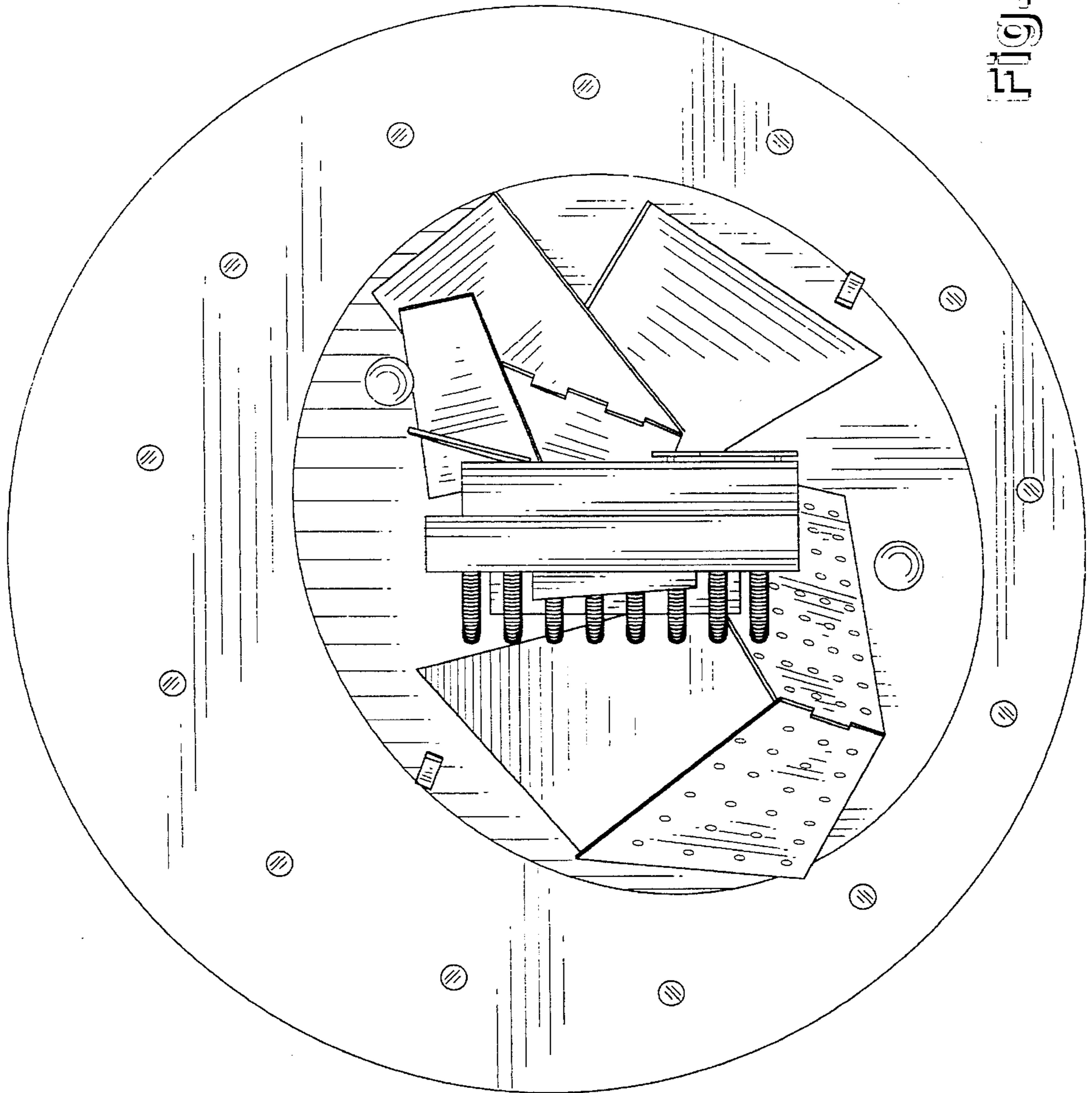

Fig. 9

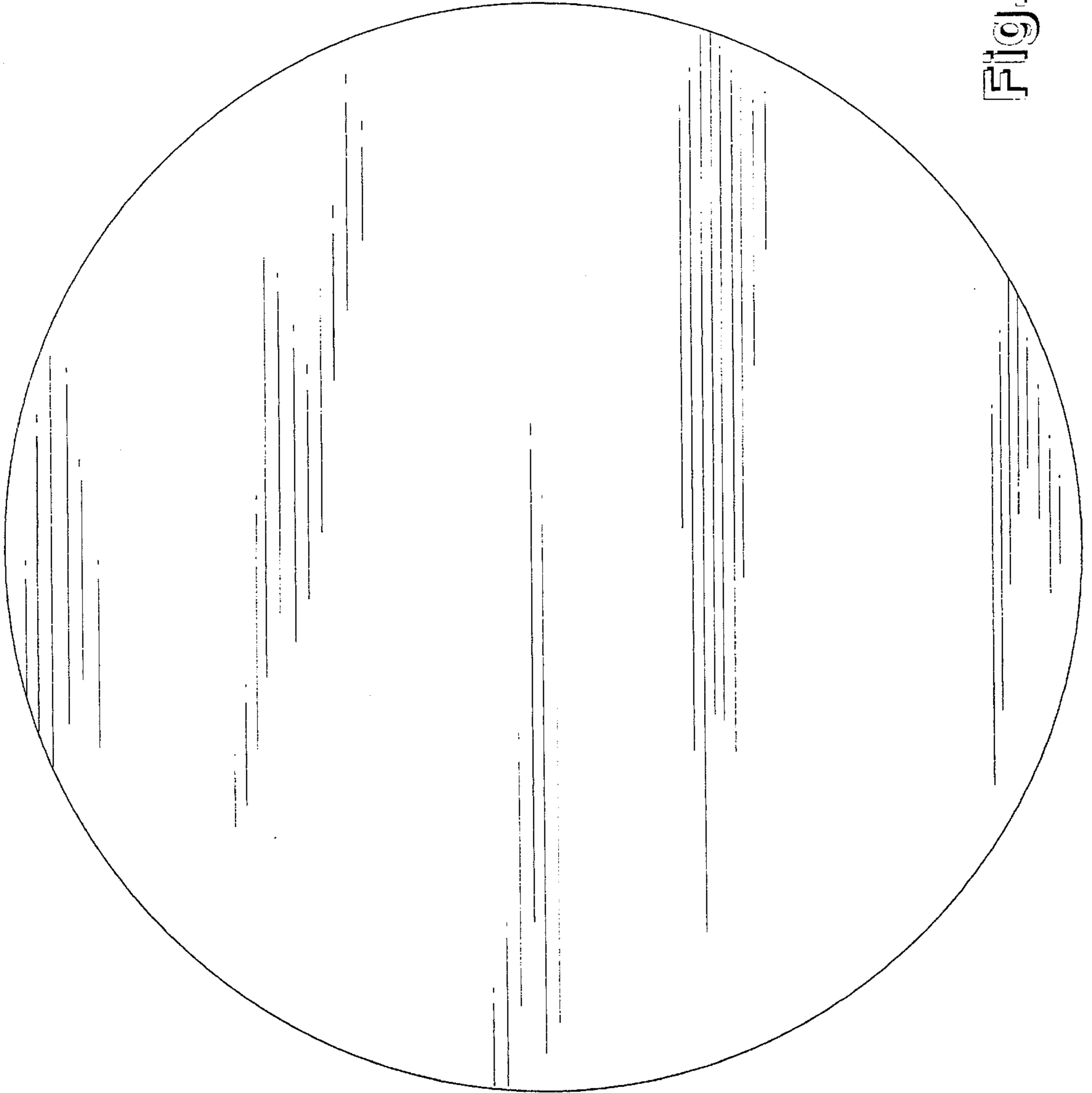

Fig. 10