



US00D370674S

**United States Patent** [19]  
**Zeitman**

[11] **Patent Number: Des. 370,674**  
[45] **Date of Patent: \*\*Jun. 11, 1996**

[54] **TELEPHONE**

[75] Inventor: **Josh Zeitman**, Brooklyn, N.Y.

[73] Assignee: **Lennox Electronics Corp.**, Brooklyn, N.Y.

[\*\*] Term: **14 Years**

[21] Appl. No.: **35,143**

[22] Filed: **Feb. 21, 1995**

[52] **U.S. Cl.** ..... **D14/151**

[58] **Field of Search** ..... D14/140, 141, D14/142, 240, 241, 248, 149-151, 147, 148; 379/419, 420, 428, 440, 433-436

[56] **References Cited**

**U.S. PATENT DOCUMENTS**

D. 280,099	8/1985	Topp	.....	D14/247
D. 281,243	11/1985	Reichenstein	.....	D14/151 X
D. 286,401	10/1986	Asaki	.....	D14/151
D. 303,665	9/1989	Ohta et al.	.....	D14/151 X
D. 307,426	4/1990	Ohta et al.	.....	D14/151 X
D. 319,829	9/1991	Wu	.....	D14/151

**OTHER PUBLICATIONS**

- B. A. Pargh 1992 Spring/Summer Catalog, p. 322, Big Button and Buttons Plus Telephones at center of page.
- B. A. Pargh 1991 Spring/Summer Catalog, p. 316, Bellsouth Telephone 173VBES.
- B. A. Pargh 1992 Spring/Summer Catalog, p. 326, Lonestar 13-Number Memory Featurephone.
- B. A. Pargh 1991 Spring/Summer Catalog, p. 320, ITT PC3485ITT Telephone.

*Primary Examiner*—Jeffrey Asch  
*Attorney, Agent, or Firm*—Natter & Natter

[57] **CLAIM**

The ornamental design of a telephone, as shown and described.

**DESCRIPTION**

FIG. 1 is a perspective view of a telephone having a base and a handpiece showing my new design;  
 FIG. 2 is a top plan view of the base;  
 FIG. 3 is a front elevational view of the telephone;  
 FIG. 4 is a left side elevational view thereof;  
 FIG. 5 is a right side elevational view thereof;  
 FIG. 6 is a rear elevational view thereof;  
 FIG. 7 is a bottom view thereof;  
 FIG. 8 is a top plan view of the handpiece;  
 FIG. 9 is a bottom view of the handpiece;  
 FIG. 10 is a right side elevational view of the handpiece, the opposite side being a mirror image of the side illustrated;  
 FIG. 11 is a rear elevational view of the handpiece; and  
 FIG. 12 is a front elevational view of the handpiece;  
 FIG. 13 is a front elevational view with the hand piece removed;  
 FIG. 14 is a rear elevational view with the hand piece removed; and,  
 FIG. 15 is a left side elevational view with the hand piece removed.

The telephone base and handset have been shown separately in FIG. 2, FIG. 8, FIG. 9, FIG. 10, FIG. 11, FIG. 12, FIG. 13, FIG. 14 and FIG. 15 for convenience of illustration.

**1 Claim, 8 Drawing Sheets**

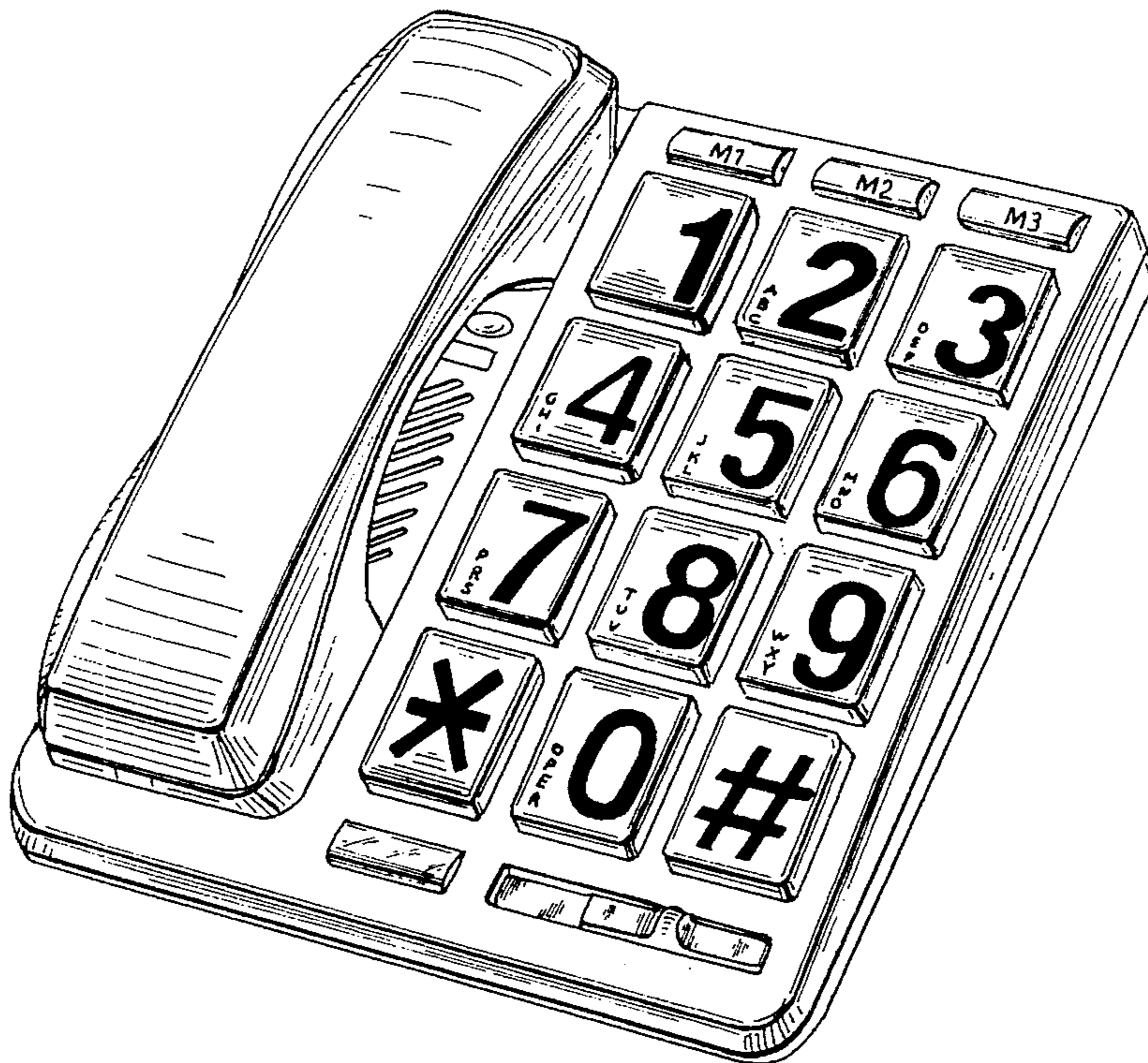

FIG. 1

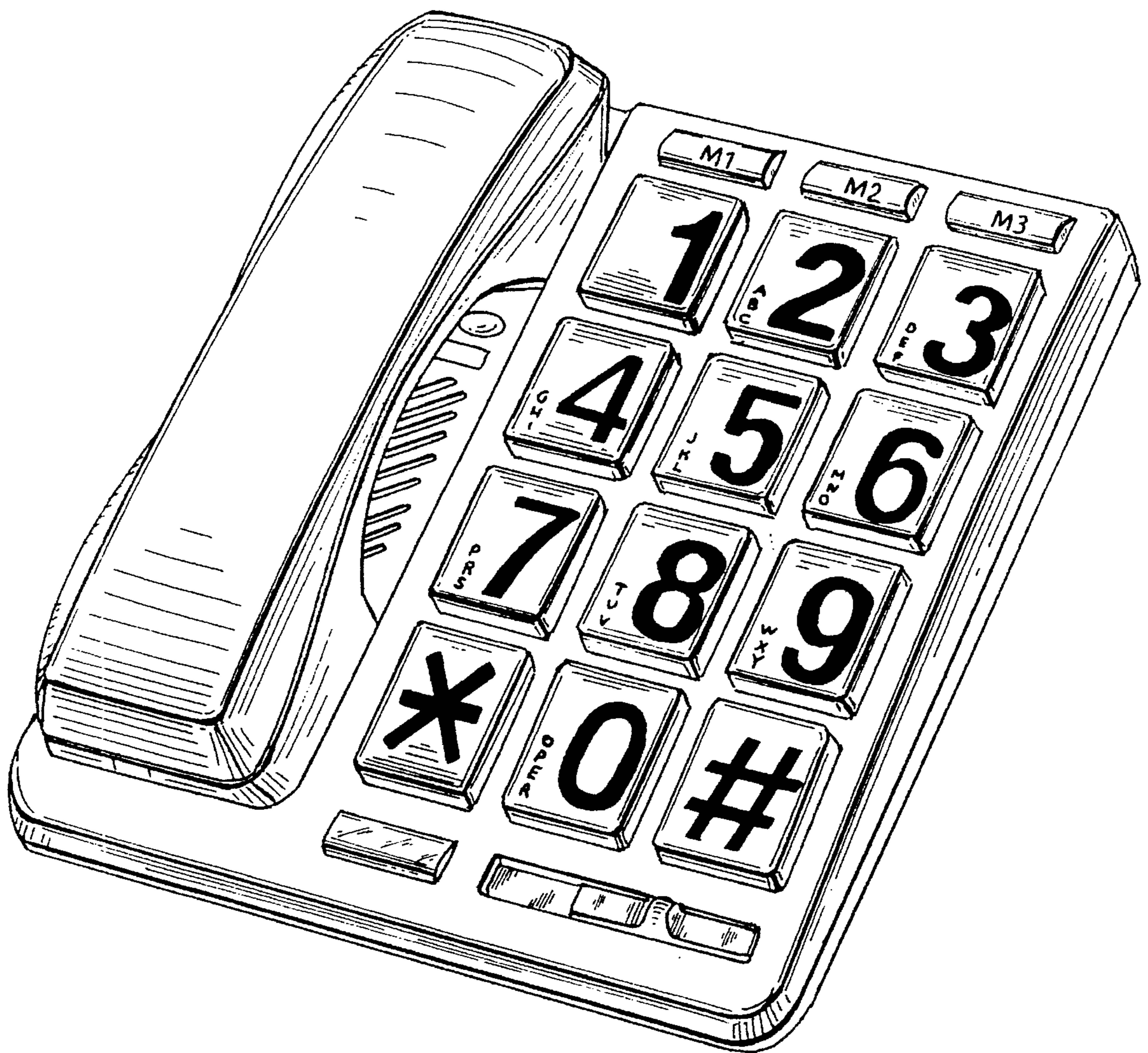

FIG. 2

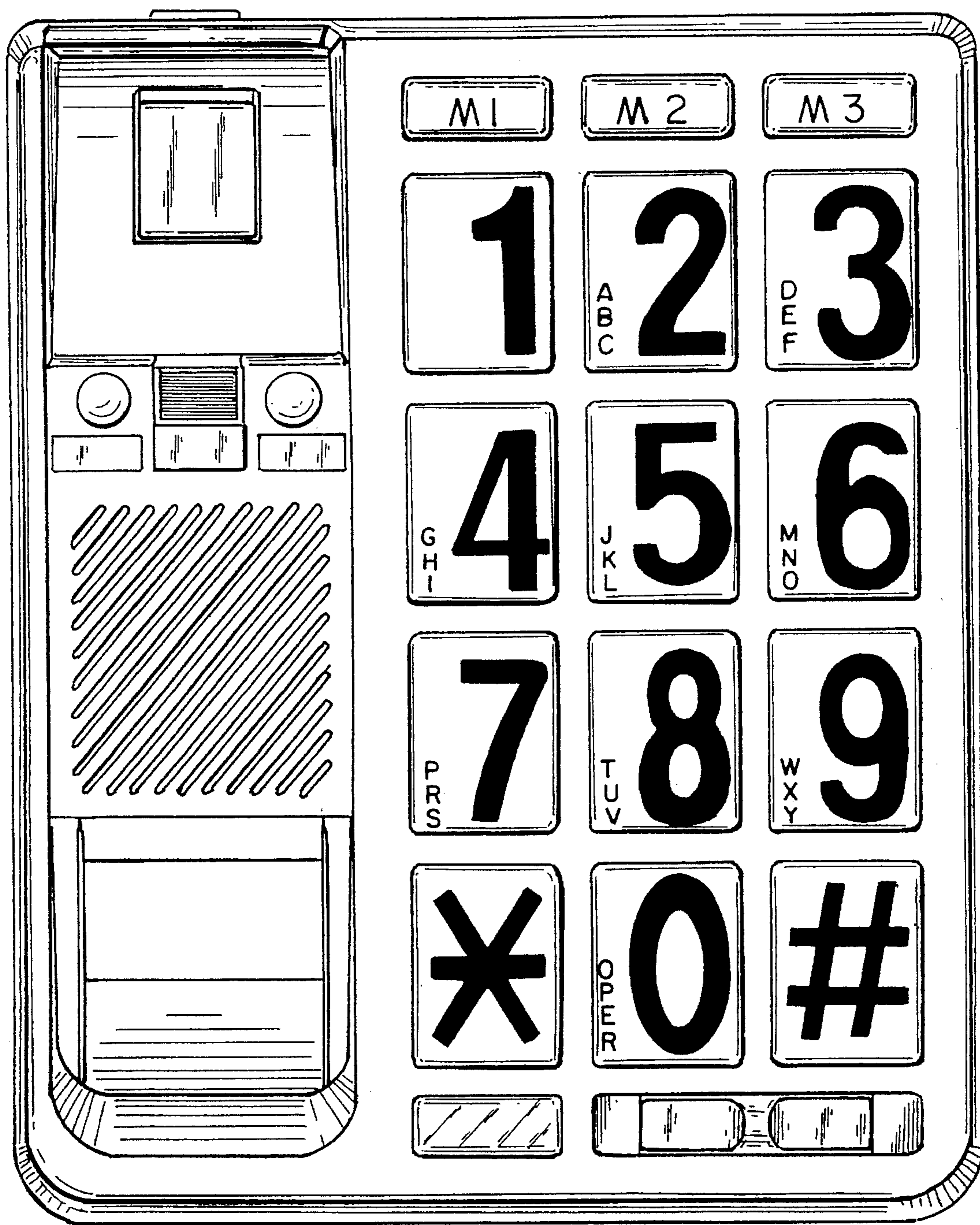

FIG. 3

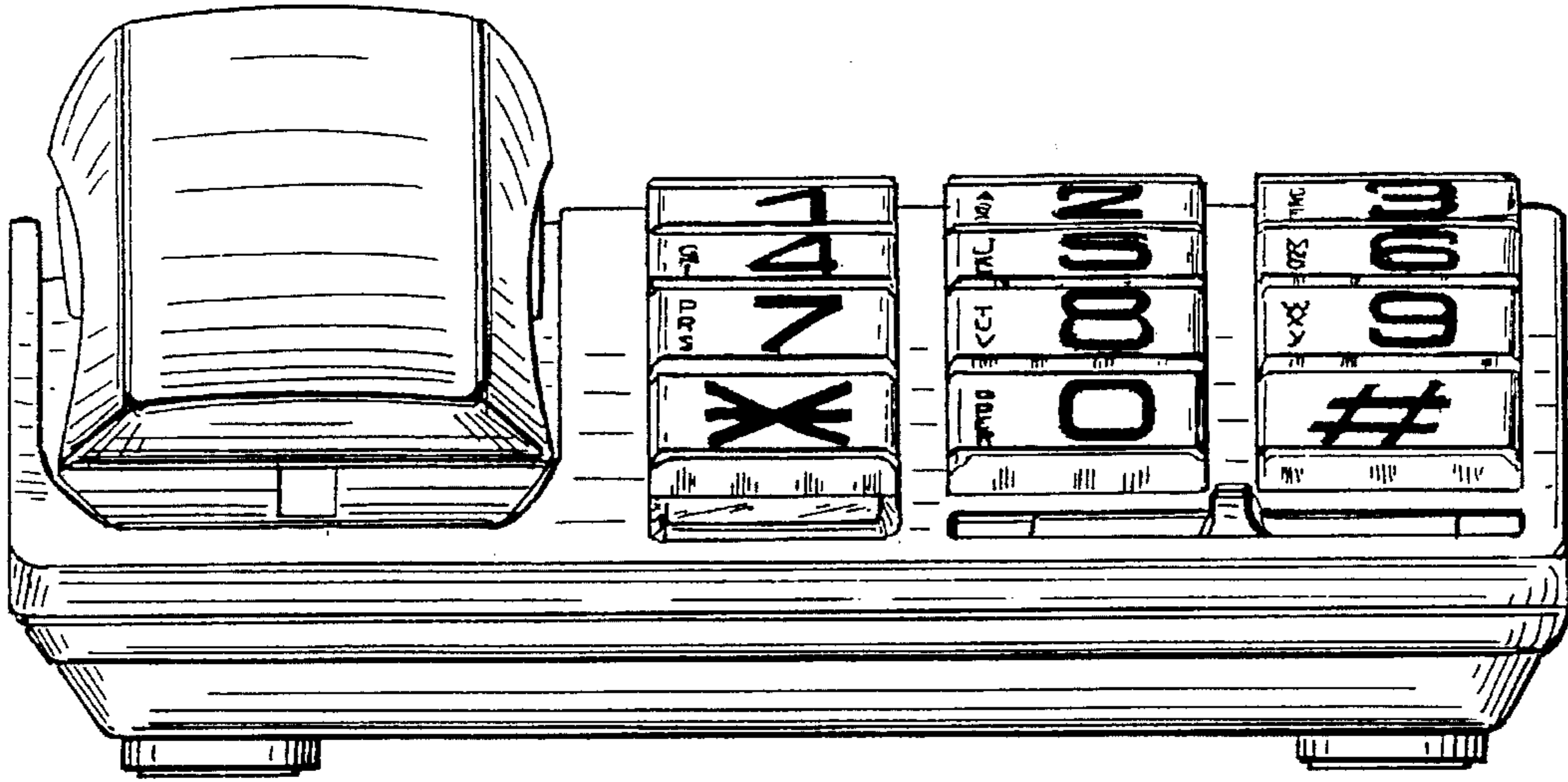

FIG. 6

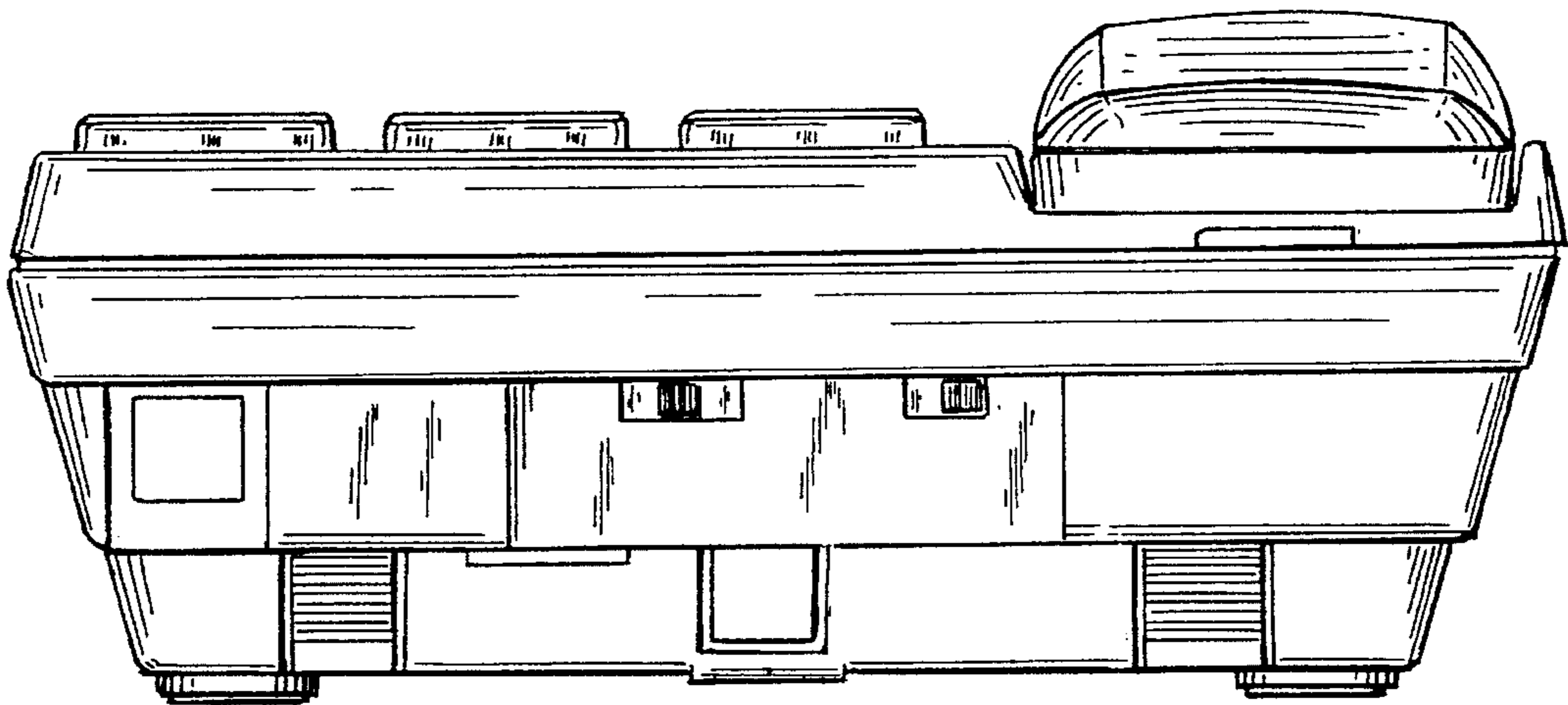

FIG. 4

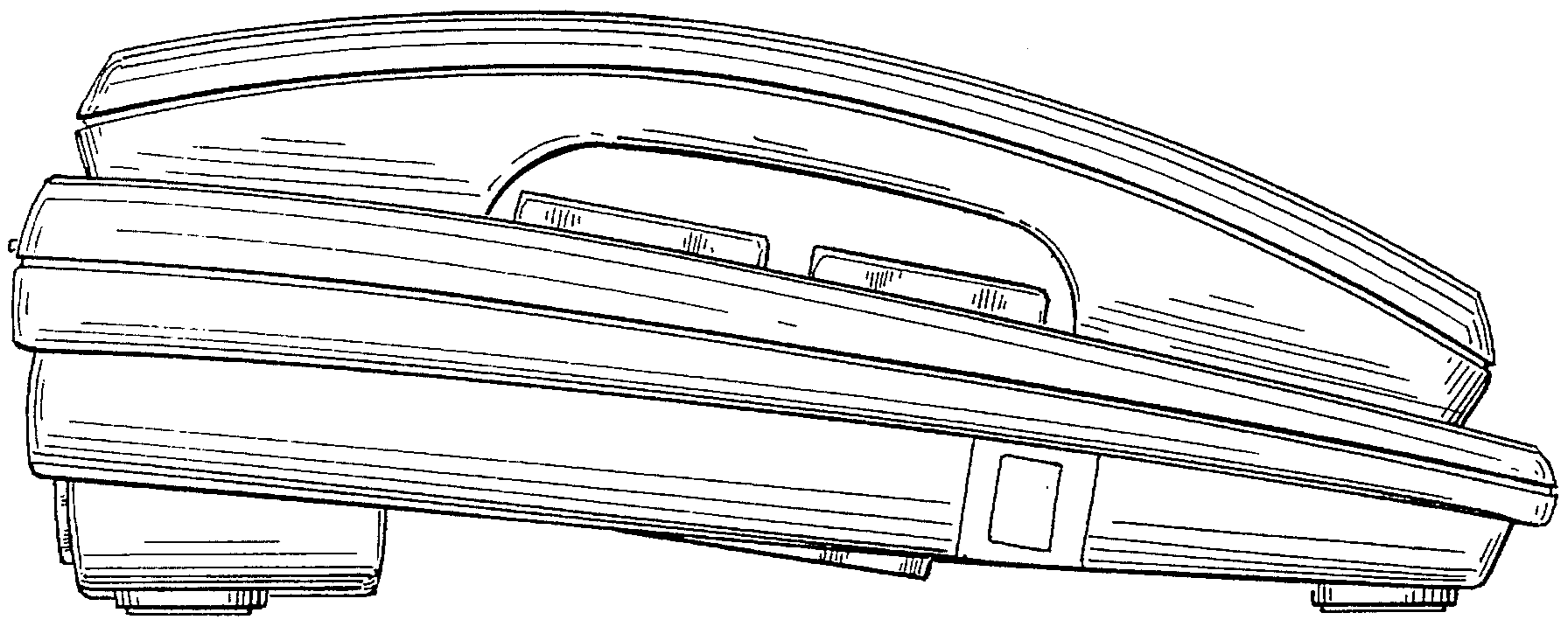

FIG. 5

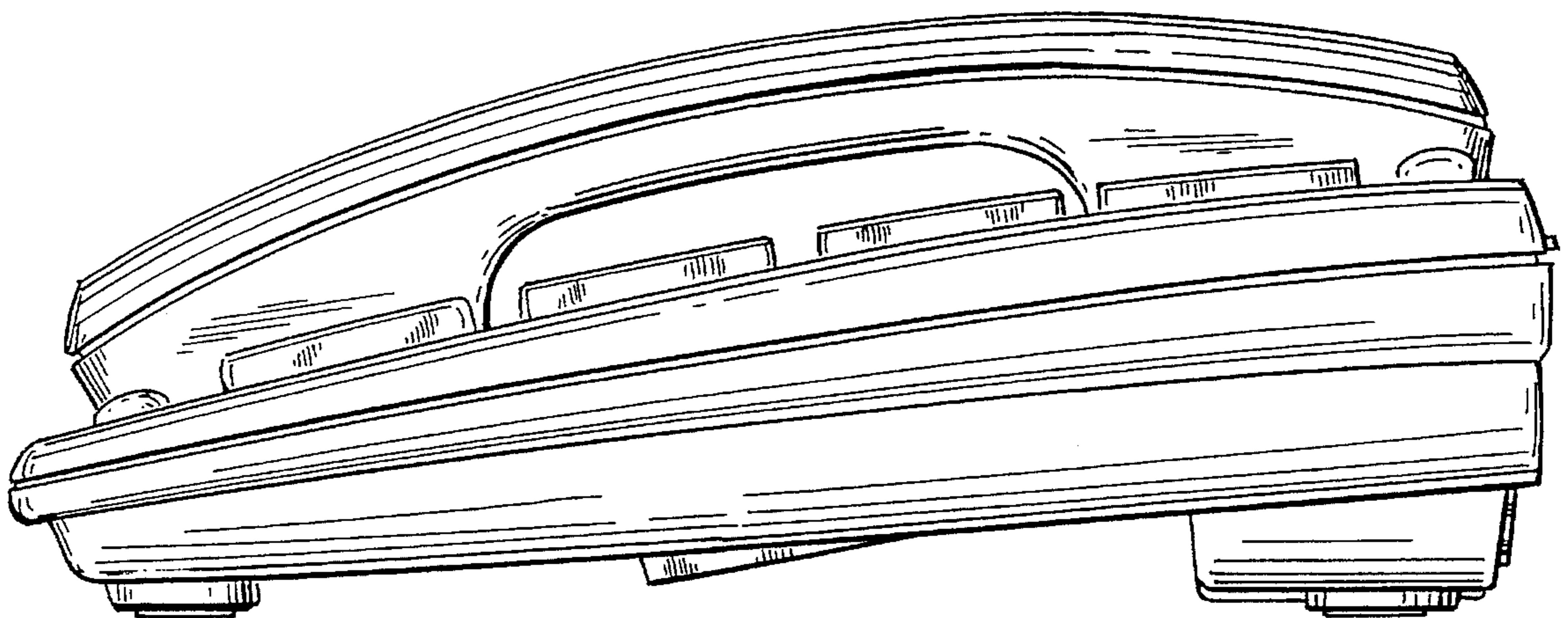

FIG. 7

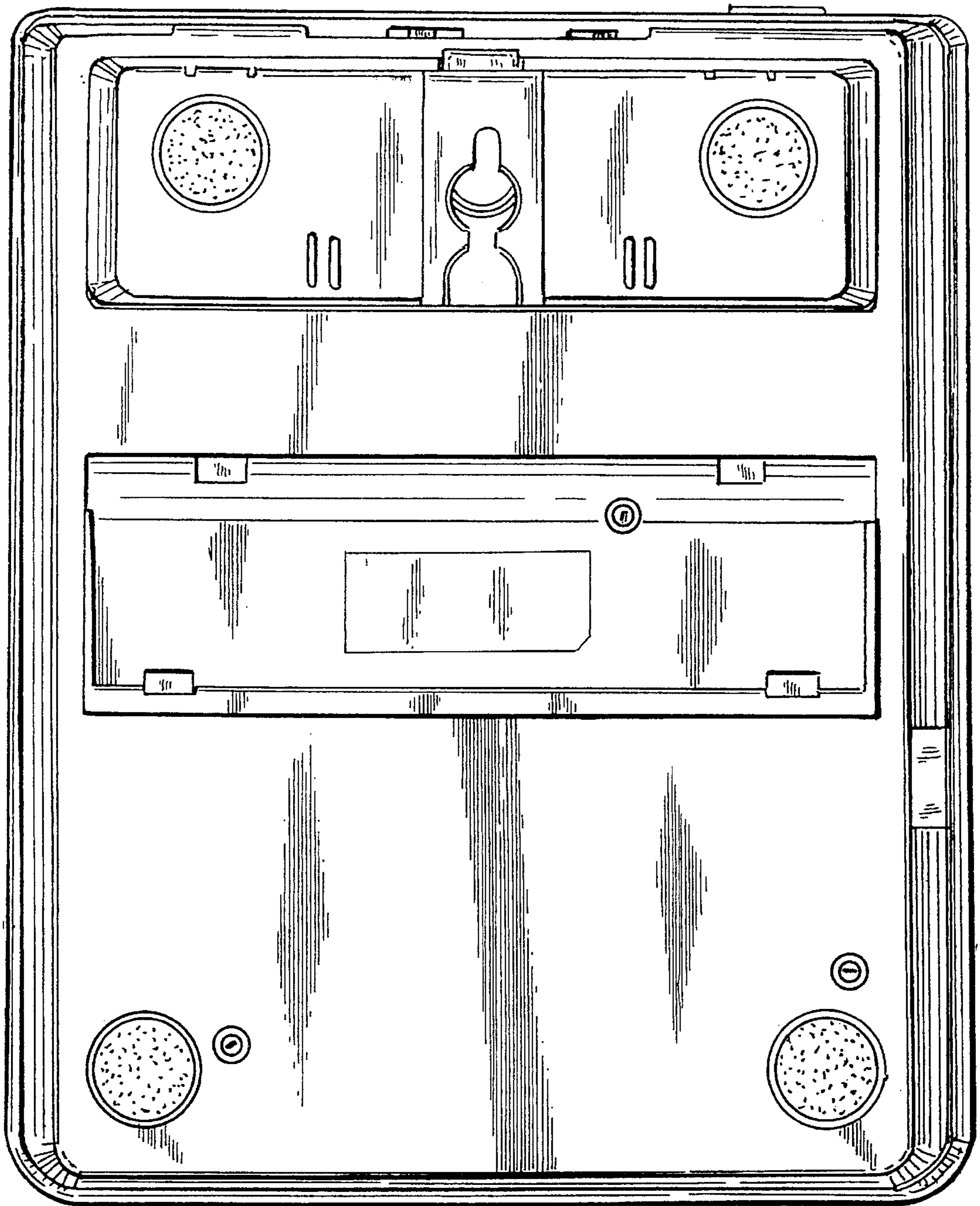

FIG. 15

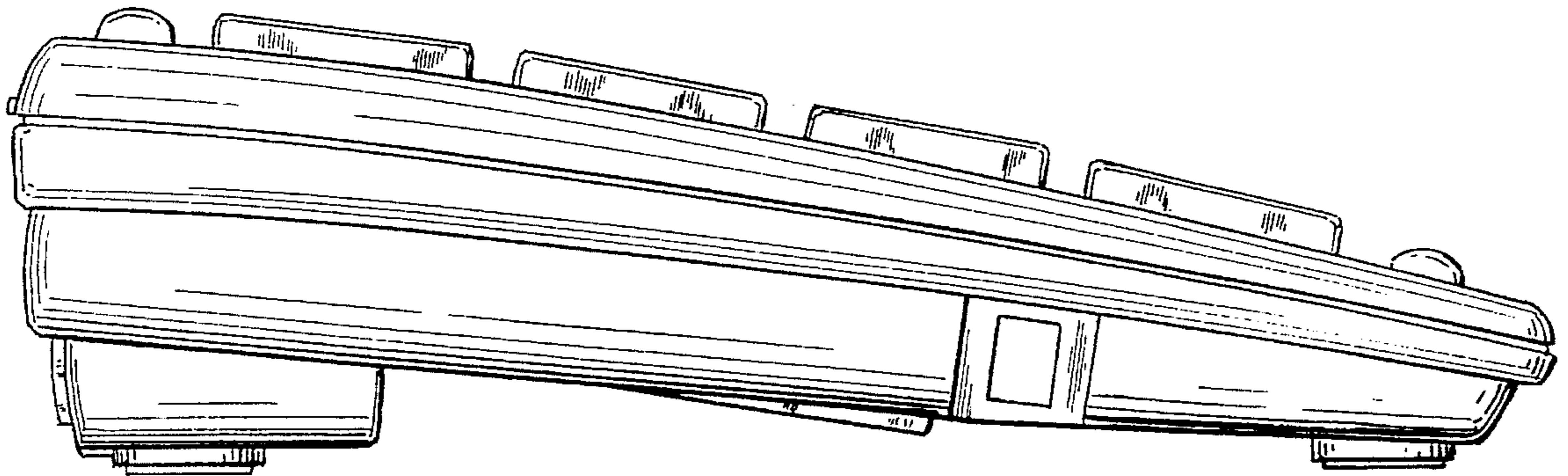

FIG. 8

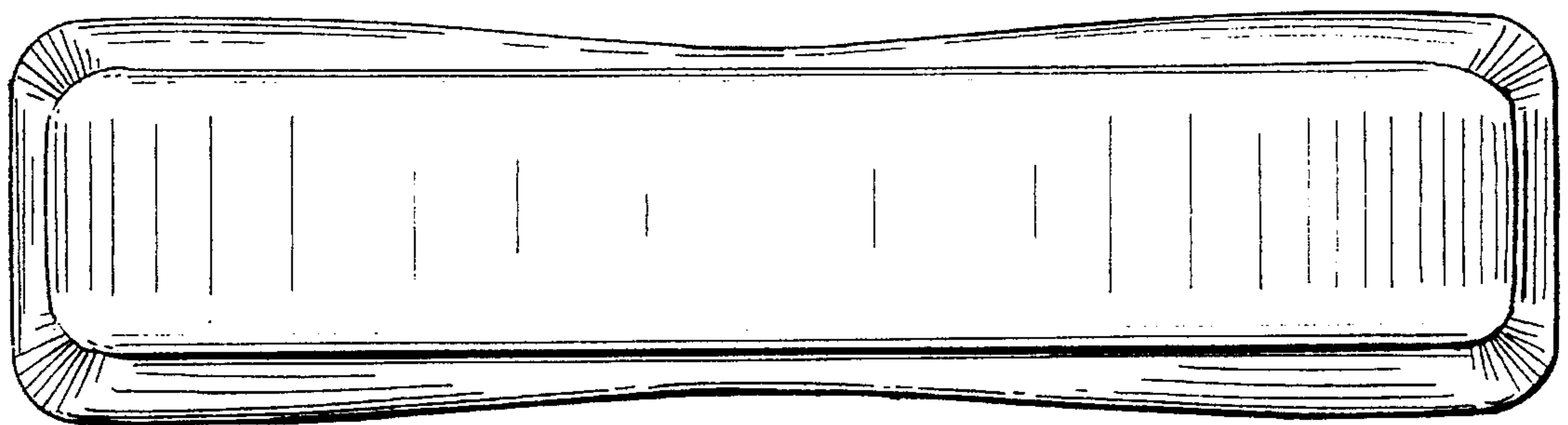

FIG. 9

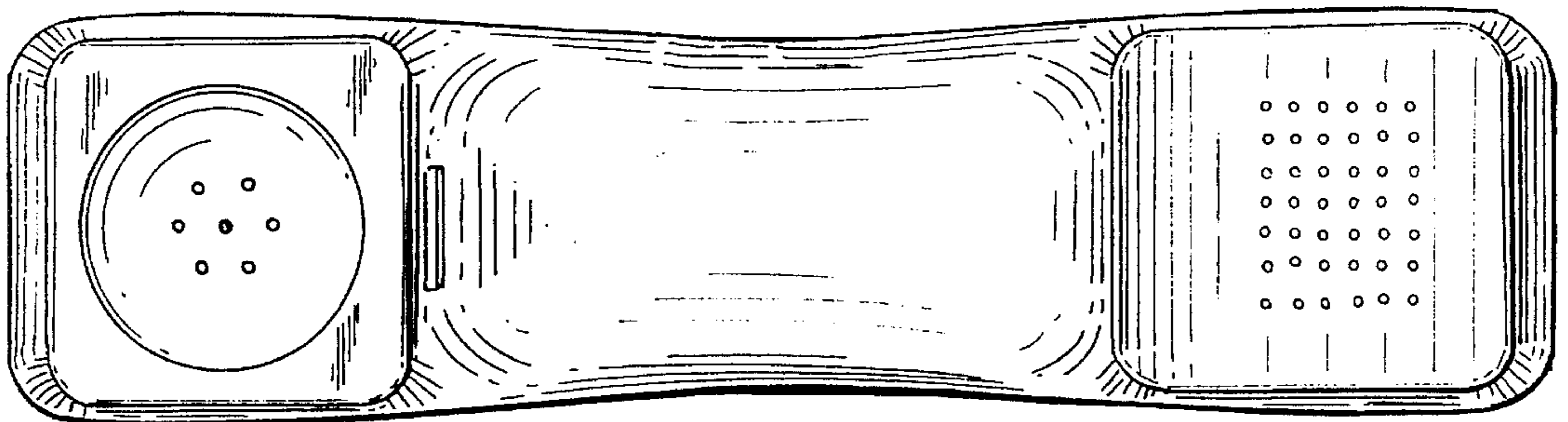

FIG. 10

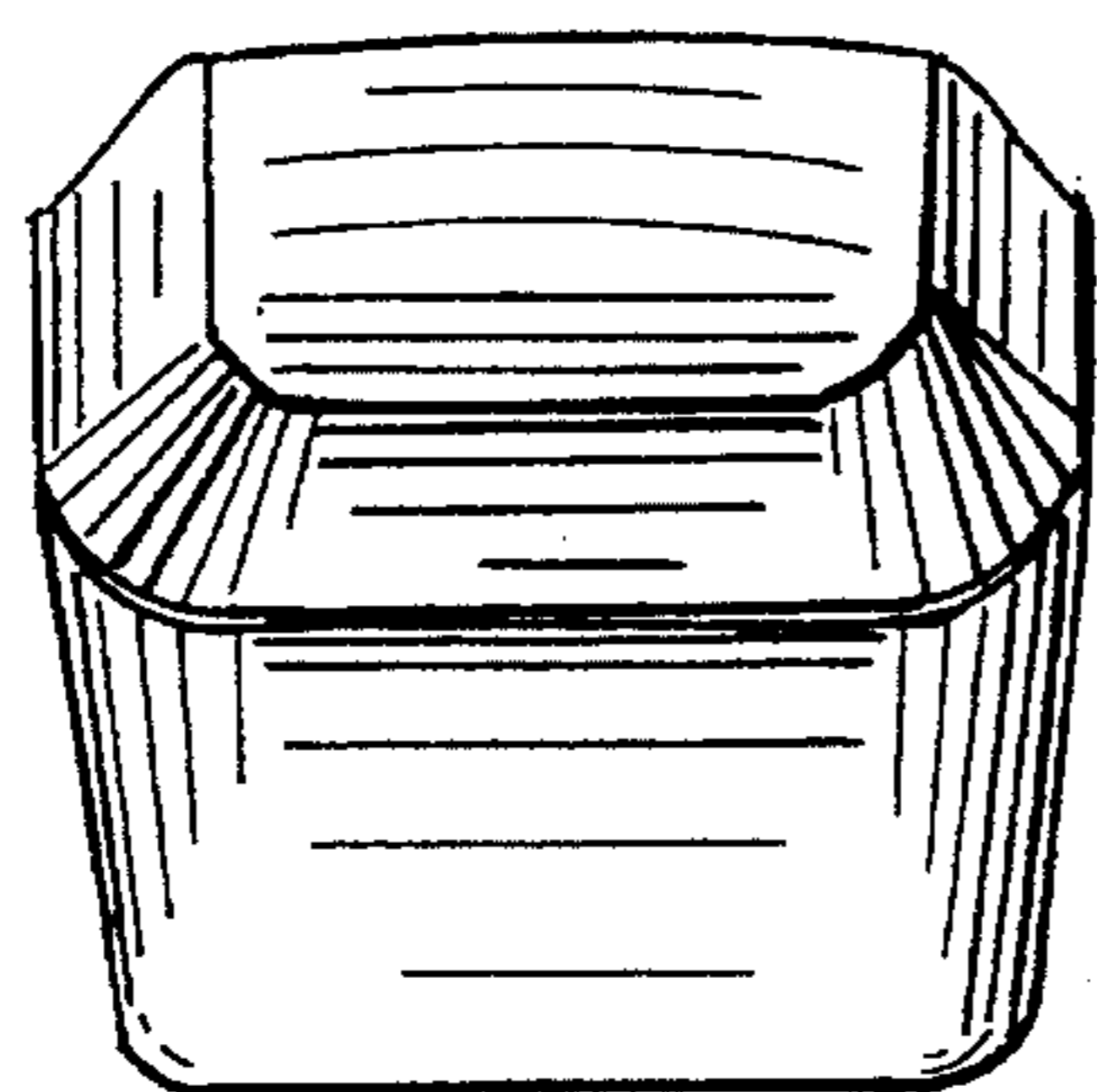
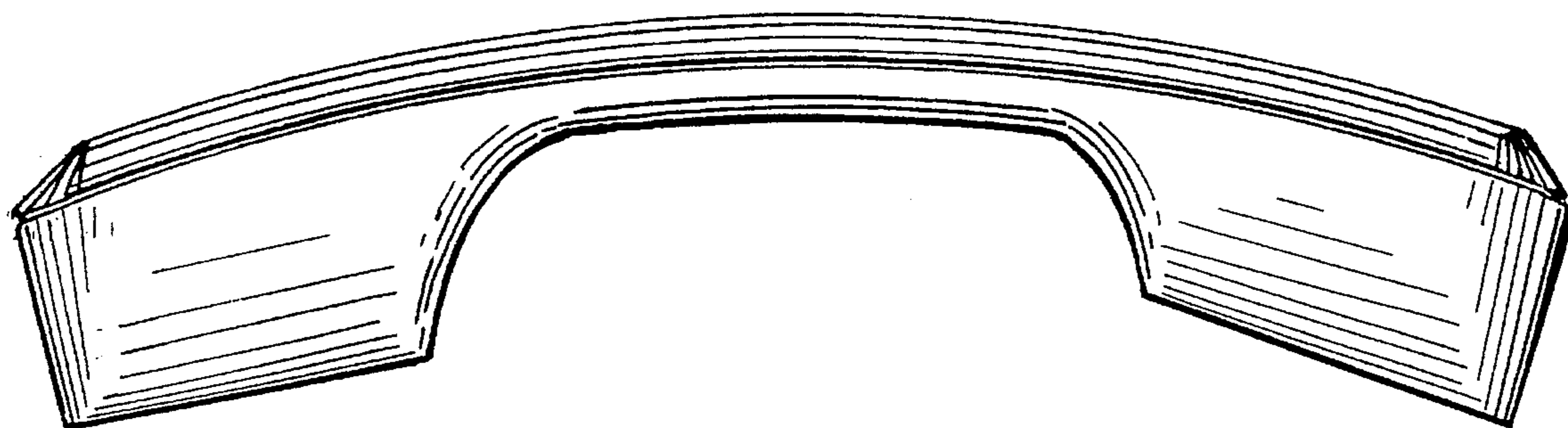

FIG. 11

FIG. 12

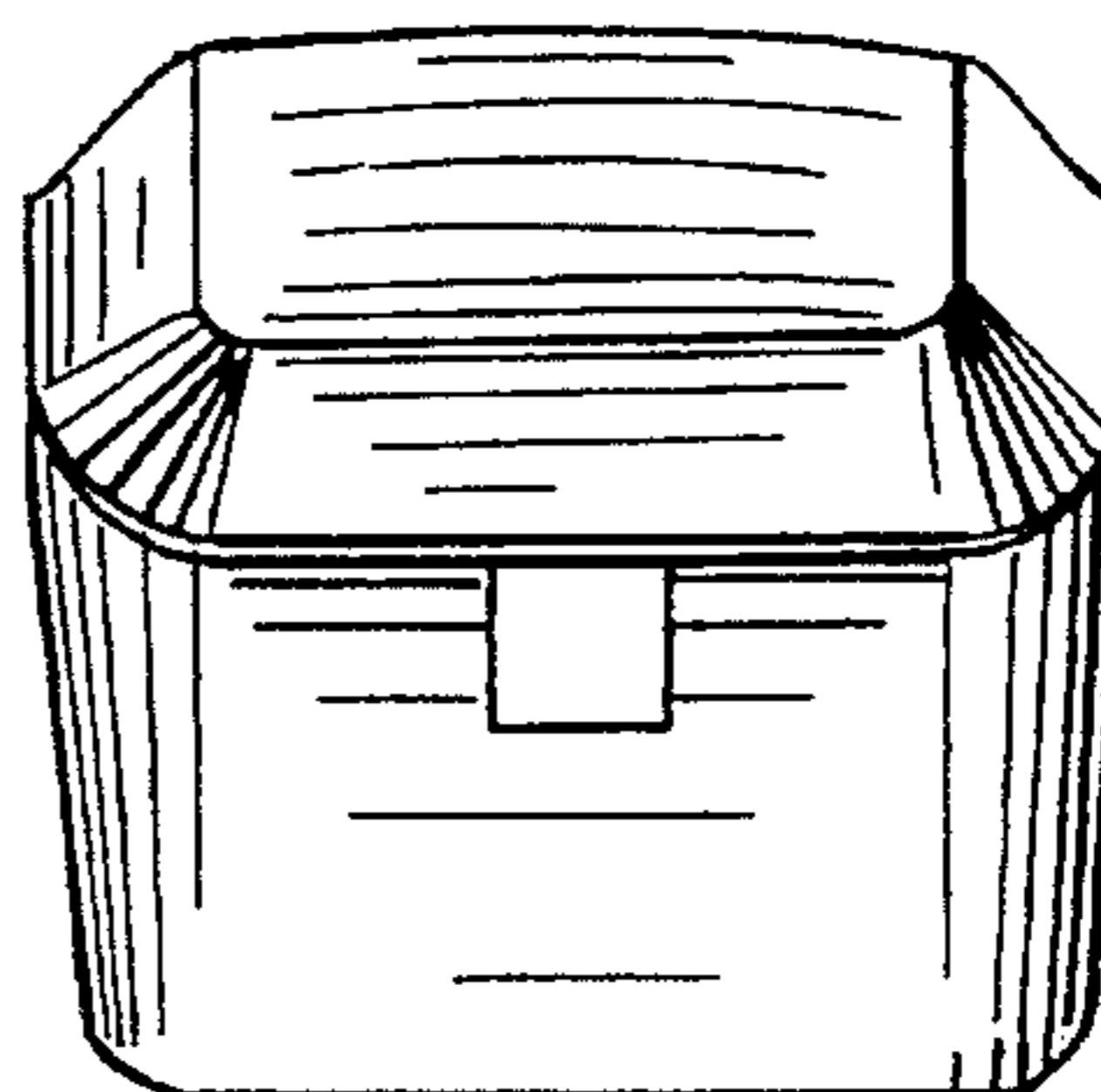



FIG. 13

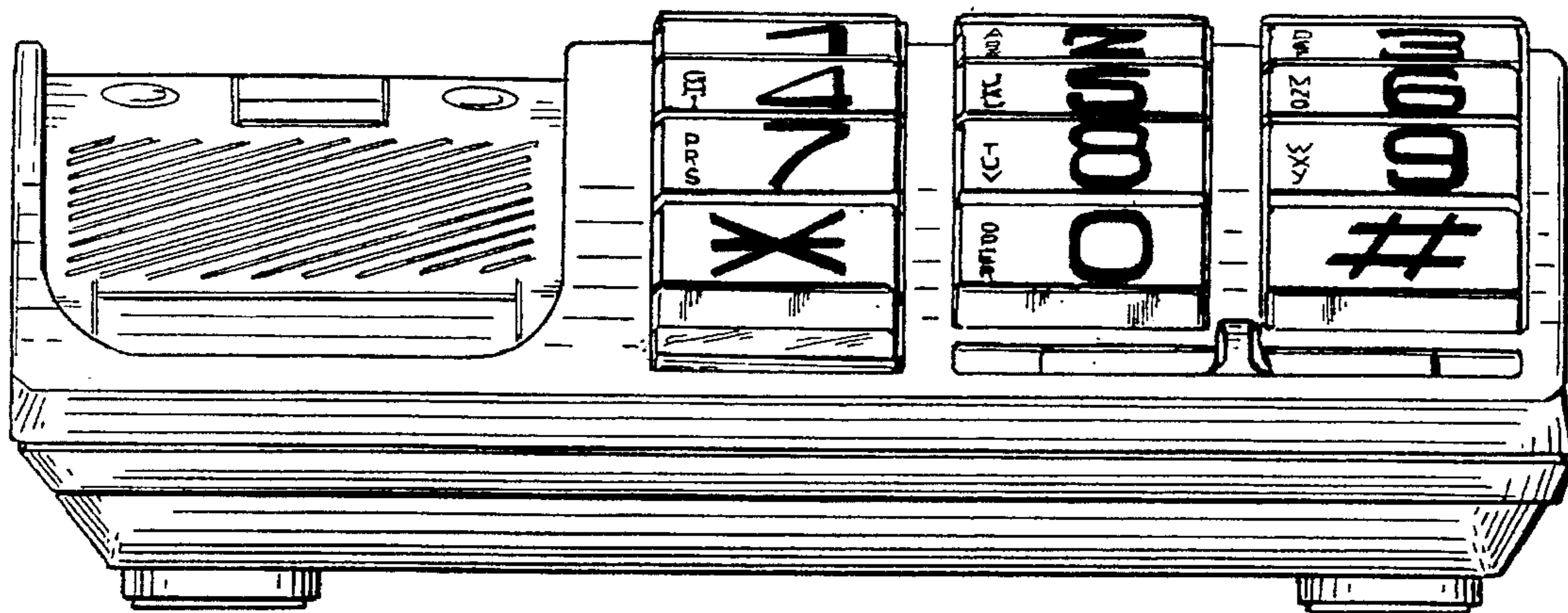

FIG. 14

