



US00D370644S

# United States Patent [19]

[11] Patent Number: **Des. 370,644**

Weder et al.

[45] Date of Patent: **\*\*\* Jun. 11, 1996**

[54] **FLOWER POT COVER**

2,355,559	8/1944	Renner	.....	229/8
3,443,741	5/1969	Stockdale	.....	D9/431 X
5,127,817	7/1992	Weder et al.	.....	425/383
5,339,565	8/1994	Weder et al.	.....	229/1.5 B X

[75] Inventors: **Donald E. Weder; Joseph G. Straeter,**  
both of Highland, Ill.

[73] Assignees: **The Family Trust U/T/A; Southpac Trust International, Inc.,** both of Okalahoma City, Okla.

**FOREIGN PATENT DOCUMENTS**

103316	3/1938	Australia	.....	229/922
--------	--------	-----------	-------	---------

**OTHER PUBLICATIONS**

[\*] Notice: The portion of the term of this patent subsequent to Aug. 15, 2009, has been disclaimed.

Exhibit A—Speed Cover ® Brochure—The Simple Solution . . . , ©1989.

[\*\*] Term: **14 Years**

*Primary Examiner*—Jeffrey Asch  
*Attorney, Agent, or Firm*—Dunlap & Coddling

[21] Appl. No.: **2,052**

[57] **CLAIM**

[22] Filed: **Dec. 1, 1992**

The ornamental design for a flower pot cover, as shown and described.

**Related U.S. Application Data**

**DESCRIPTION**

[63] Continuation-in-part of Ser. No. 807,673, Dec. 16, 1991, which is a continuation-in-part of Ser. No. 710,272, Jun. 4, 1991, which is a continuation-in-part of Ser. No. 617,454, Nov. 21, 1990, abandoned, Ser. No. 411,249, Sep. 22, 1989, Pat. No. Des. 358,113, Ser. No. 411,247, Sep. 22, 1989, and Ser. No. 411,245, Sep. 22, 1989.

FIG. 1 is a perspective view of our new flower pot cover design;

[52] **U.S. Cl.** ..... **D11/164**

FIG. 2 is a side elevational view thereof;

[58] **Field of Search** ..... D11/143, 149, D11/152–156, 164, 89, 90; 47/66, 72; 206/423; 215/100.5; 229/1.5 R, 1.5 B, 4.5, 87.01, 922, 930, 108, 108.1, 109, 110; 428/27, 35.1, 24, 542.6; D9/346, 428–431; D27/102, 133; D26/128–136; D19/96; D7/540, 584, 586, 587, 354

FIG. 3 is a top plan view thereof;

FIG. 4 is a bottom plan view thereof;

FIG. 5 is a side elevational view of the design of FIG. 1, the only difference being in the horizontal angle of the skirt;

FIG. 6 is a side elevational view of the design of FIG. 1, the only difference being in the near vertical angle of the skirt;

FIG. 7 is a side elevational view of the design of FIG. 1, the only difference being in the downward angle of the skirt;

FIG. 8 is a perspective view of a second embodiment of our new flower pot cover design;

[56] **References Cited**

**U.S. PATENT DOCUMENTS**

D. 292,182	10/1987	Weder et al.	.....	D11/164
D. 292,562	11/1987	Weder et al.	.....	D11/164
D. 293,224	12/1987	Weder et al.	.....	D11/164
D. 293,775	1/1988	Weder et al.	.....	D11/164
D. 317,583	6/1991	Weder et al.	.....	D11/164
D. 318,030	7/1991	Weder et al.	.....	D11/164
D. 327,234	6/1992	Vaughn	.....	D11/143
1,065,486	6/1913	Washburn	.....	229/400
2,054,934	9/1936	Graffenberger	.....	229/1.5 B
2,102,510	12/1937	Cecil	.....	229/1.5 B

FIG. 9 is a side elevational view thereof;

FIG. 10 is a top plan view thereof;

FIG. 11 is a bottom plan view thereof;

FIG. 12 is a side elevational view of the design of FIG. 8, the only difference being in the horizontal angle of the skirt;

FIG. 13 is a side elevational view of the design of FIG. 8, the only difference being in the near vertical angle of the skirt;

FIG. 14 is a side elevational view of the design of FIG. 8, the only difference being in the downward angle of the skirt;

FIG. 15 is a perspective view of a third embodiment of our new flower pot cover design;

FIG. 16 is a side elevational view thereof;

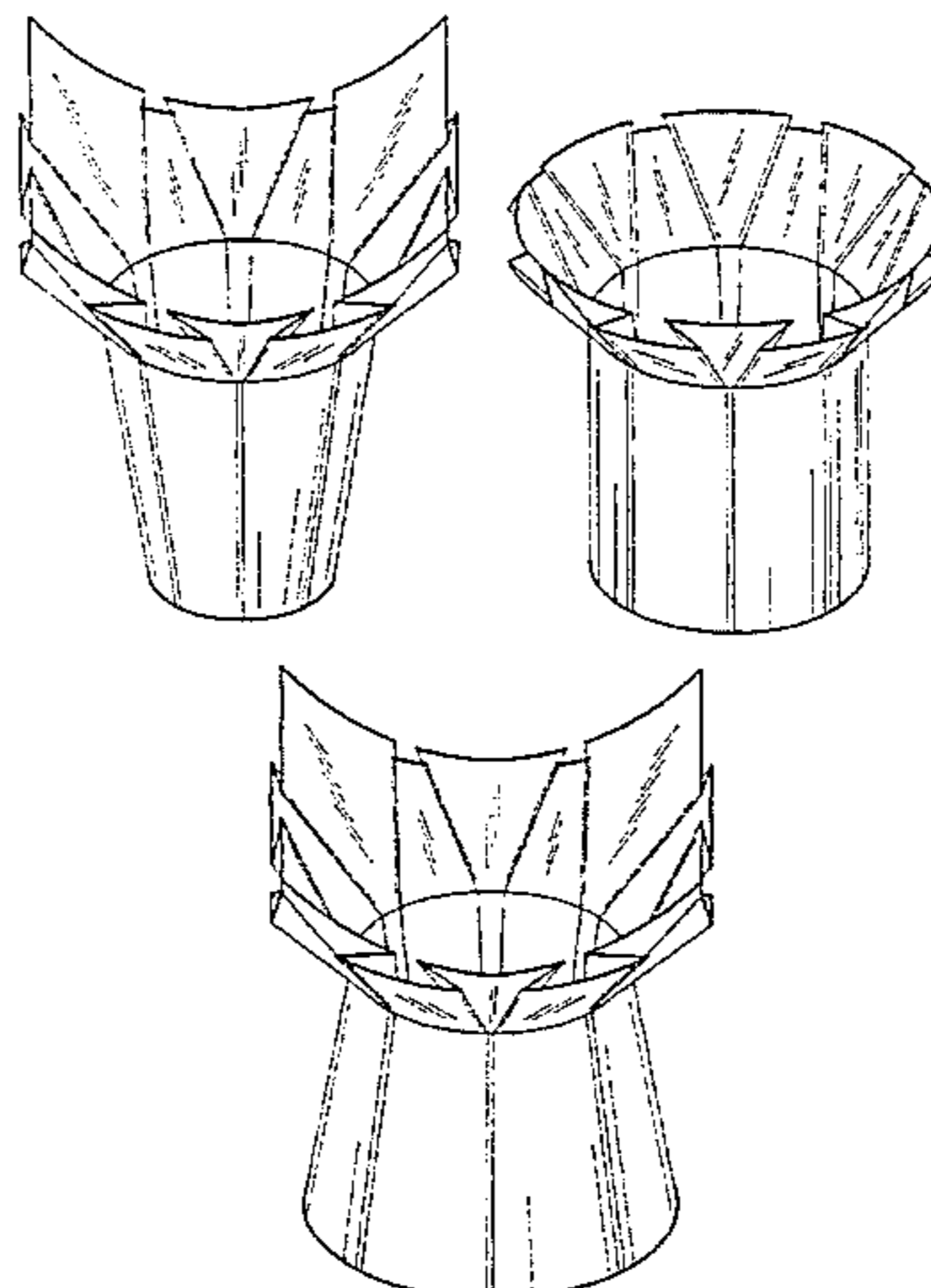

FIG. 17 is a top plan view thereof;

FIG. 18 is a bottom plan view thereof;

FIG. 19 is a side elevational view of the design of FIG. 15, the only difference being in the horizontal angle of the skirt;

FIG. 20 is a side elevational view of the design of FIG. 15, the only difference being in the near vertical angle of the skirt;

FIG. 21 is a side elevational view of the design of FIG. 15, the only difference being in the downward angle of the skirt;

FIG. 22 is a perspective view of a fourth embodiment of our new flower pot cover design;

FIG. 23 is a side elevational view thereof;

FIG. 24 is a top plan view thereof;

FIG. 25 is a bottom plan view thereof;

FIG. 26 is a side elevational view of the design of FIG. 22, the only difference being in the horizontal angle of the skirt;

FIG. 27 is a side elevational view of the design of FIG. 22, the only difference being in the near vertical angle of the skirt;

FIG. 28 is a side elevational view of the design of FIG. 22, the only difference being in the downward angle of the skirt;

FIG. 29 is a perspective view of a fifth embodiment of our new flower pot cover design;

FIG. 30 is a side elevational view thereof;

FIG. 31 is a top plan view thereof;

FIG. 32 is a bottom plan view thereof;

FIG. 33 is a side elevational view of the design of FIG. 29, the only difference being in the horizontal angle of the skirt;

FIG. 34 is a side elevational view of the design of FIG. 29, the only difference being in the near vertical angle of the skirt; and,

FIG. 35 is a side elevational view of the design of FIG. 29, the only difference being in the downward angle of the skirt.

The characteristic feature of the design resides in the specific pleating arrangement, comprised of the parallel disposition of the exterior folds, in combination with the interior V-shaped folds, all as best seen in FIGS. 1, 8, 15, 22 and 29.

**1 Claim, 6 Drawing Sheets**

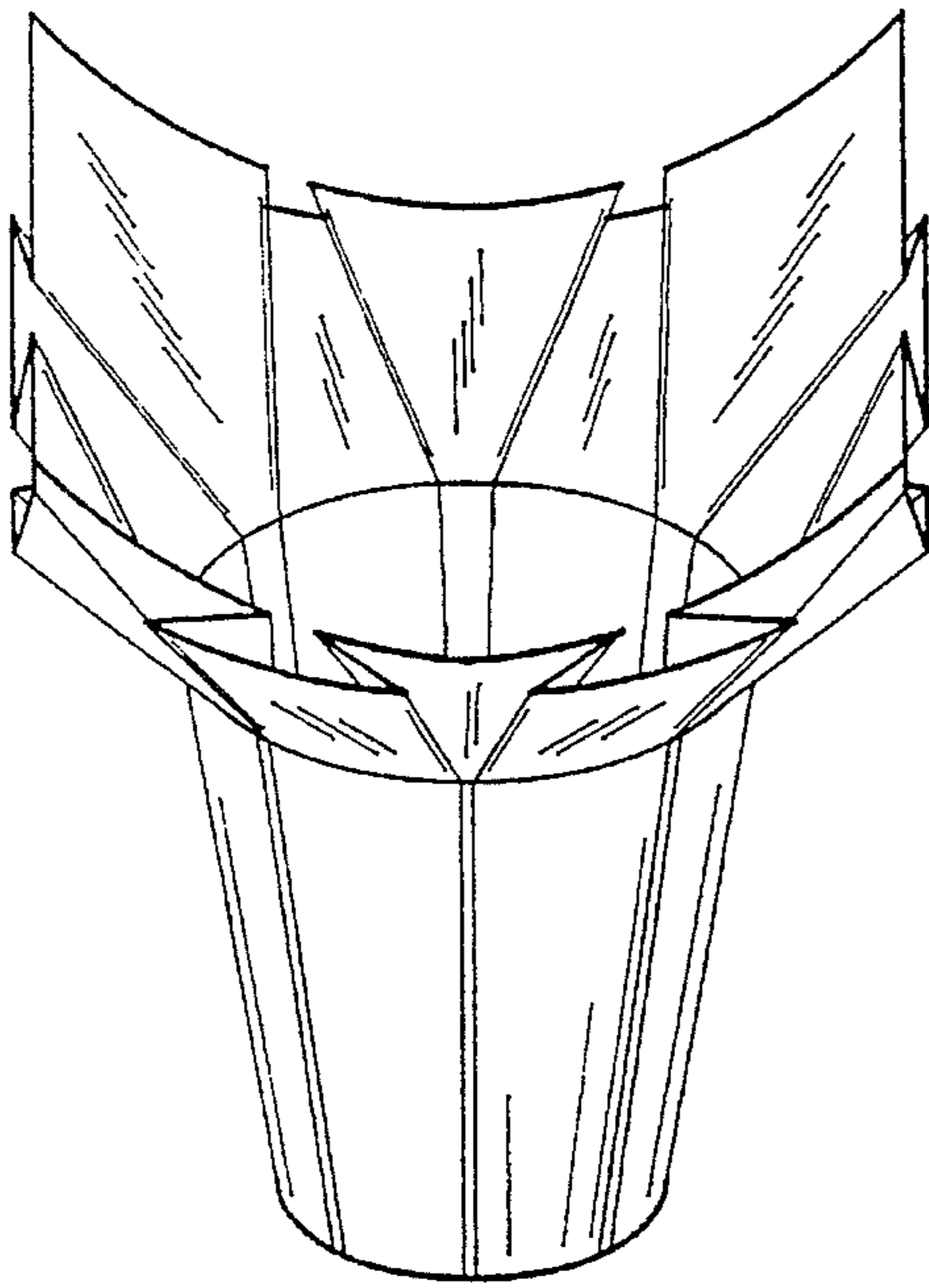

FIG. 1

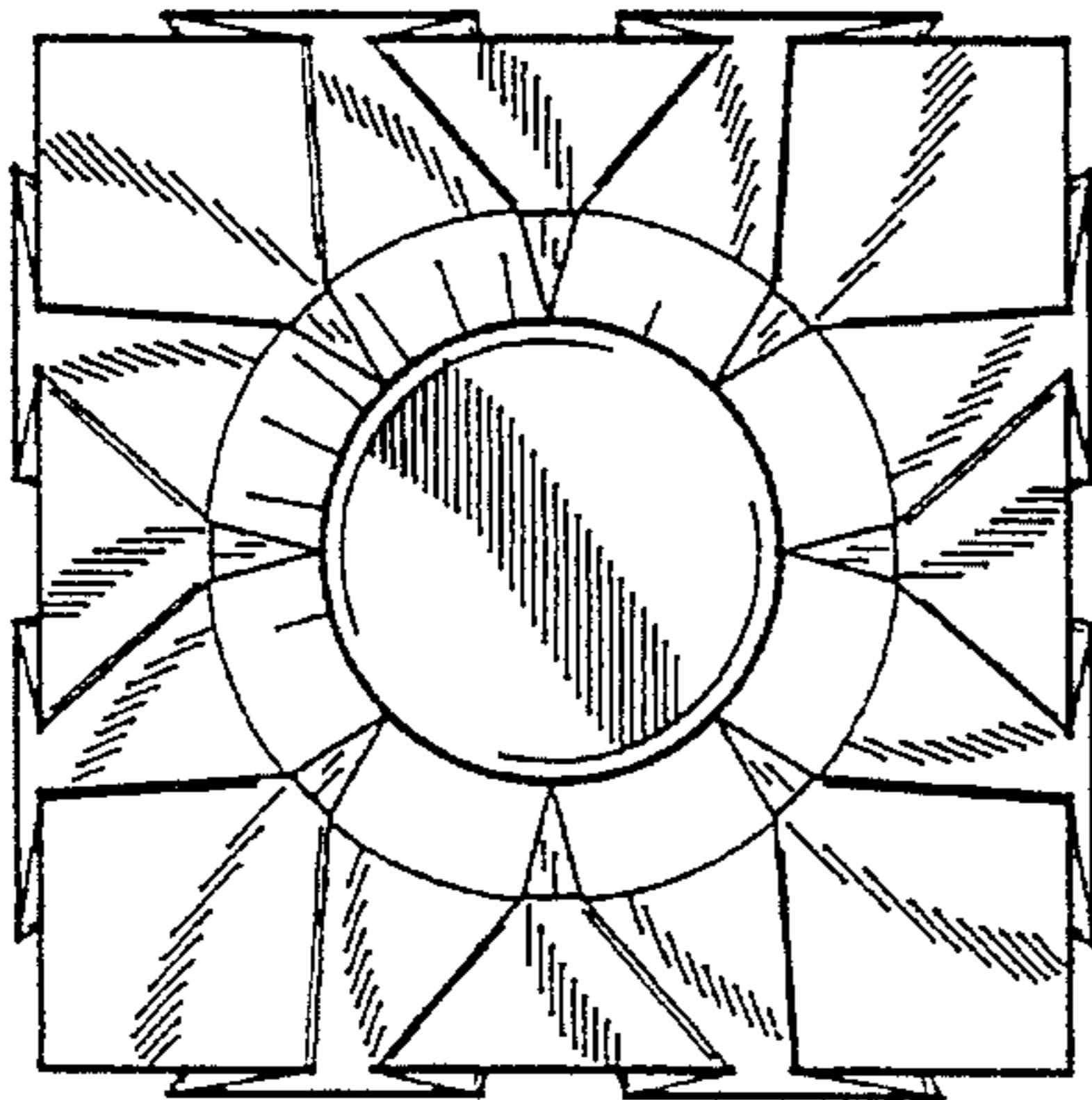

FIG. 2

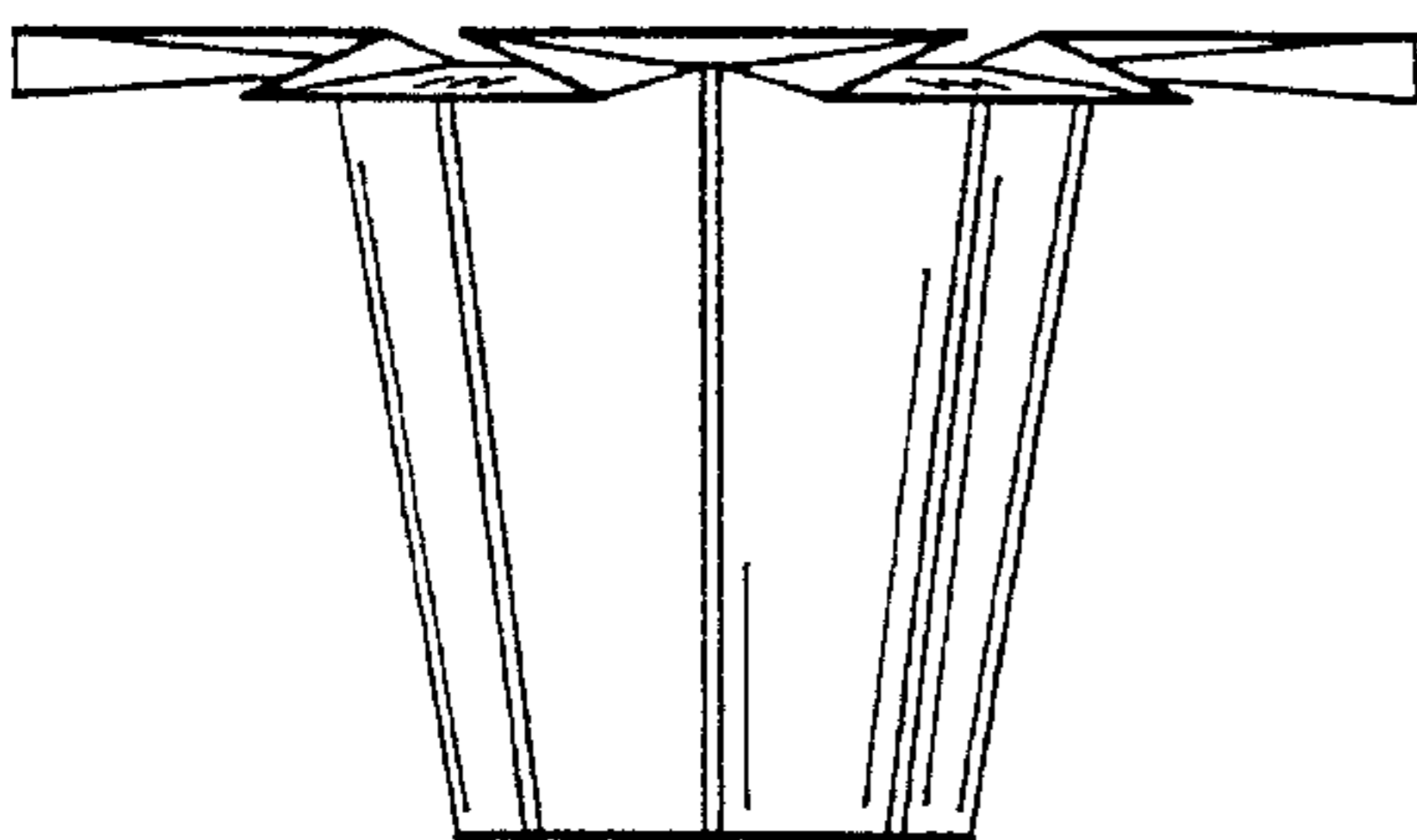

FIG. 3

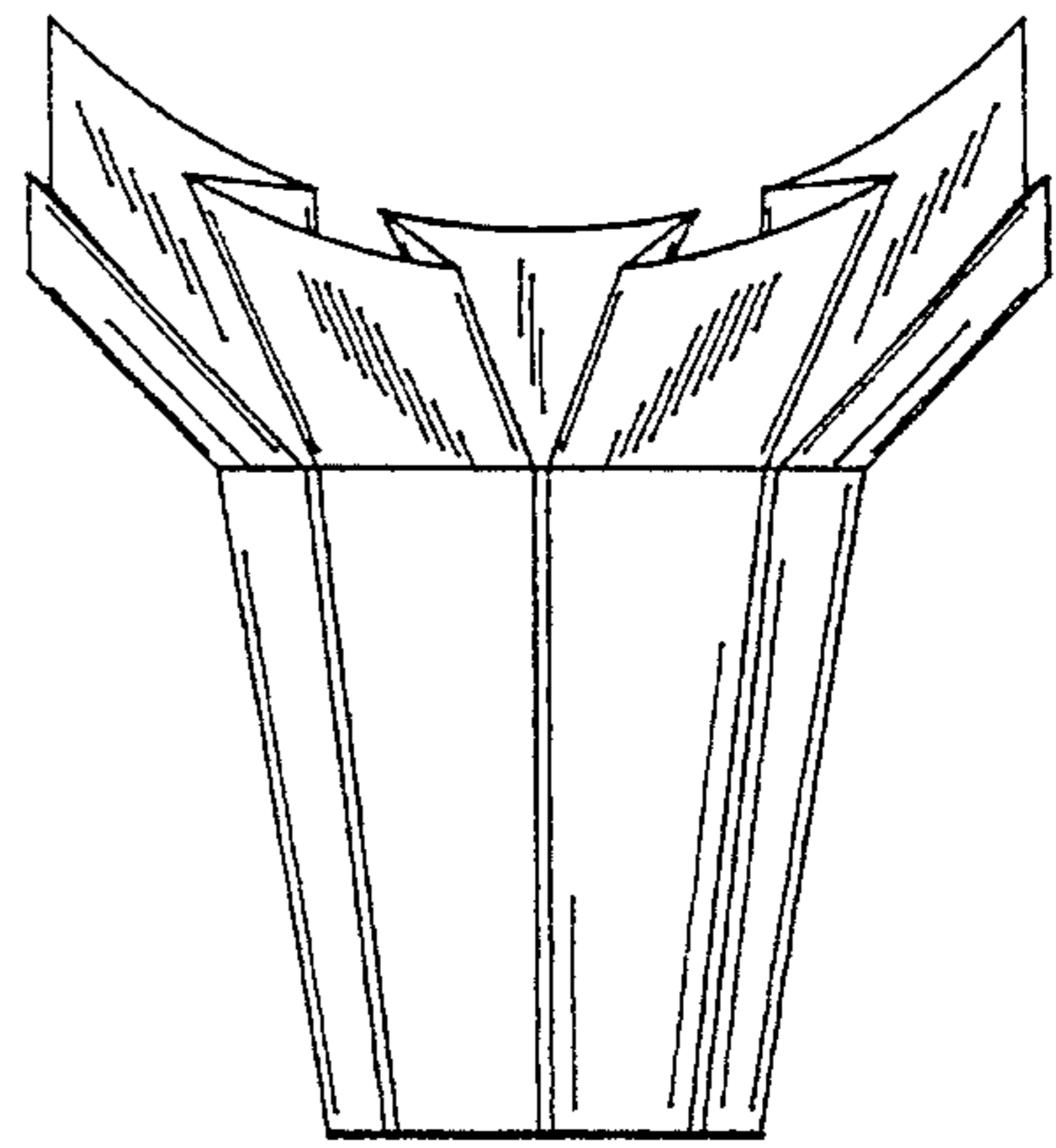

FIG. 4

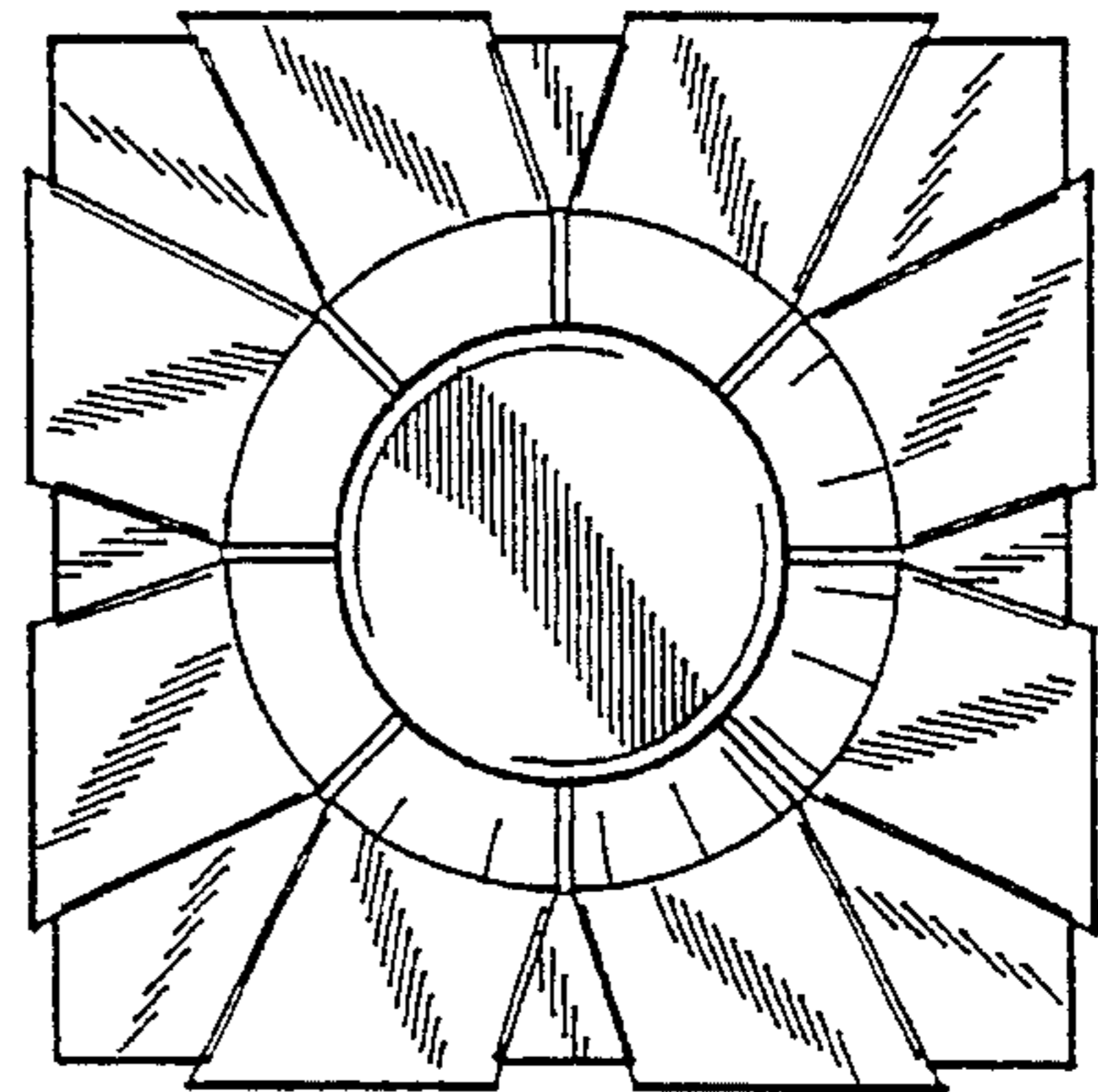

FIG. 5

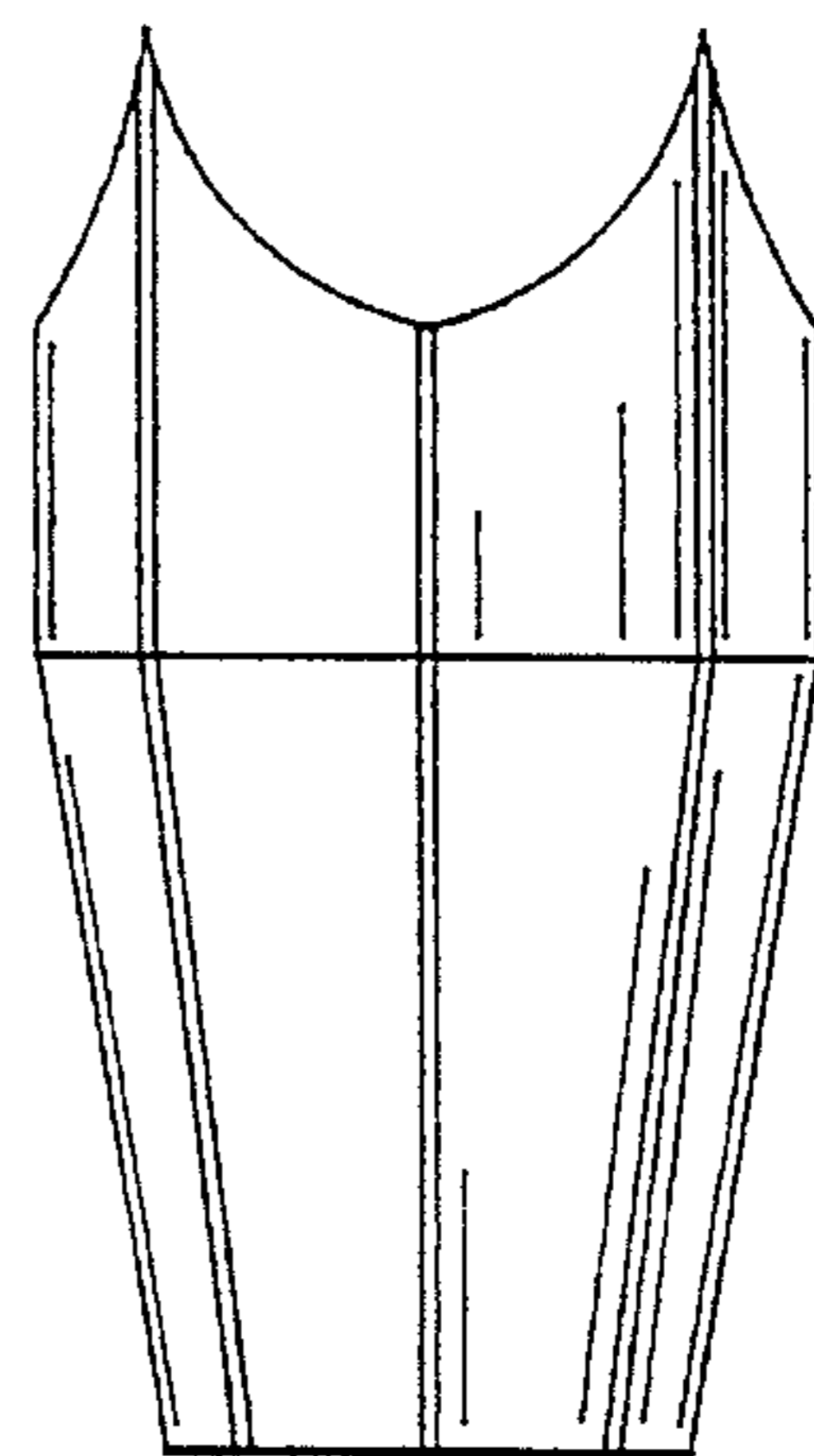

FIG. 6

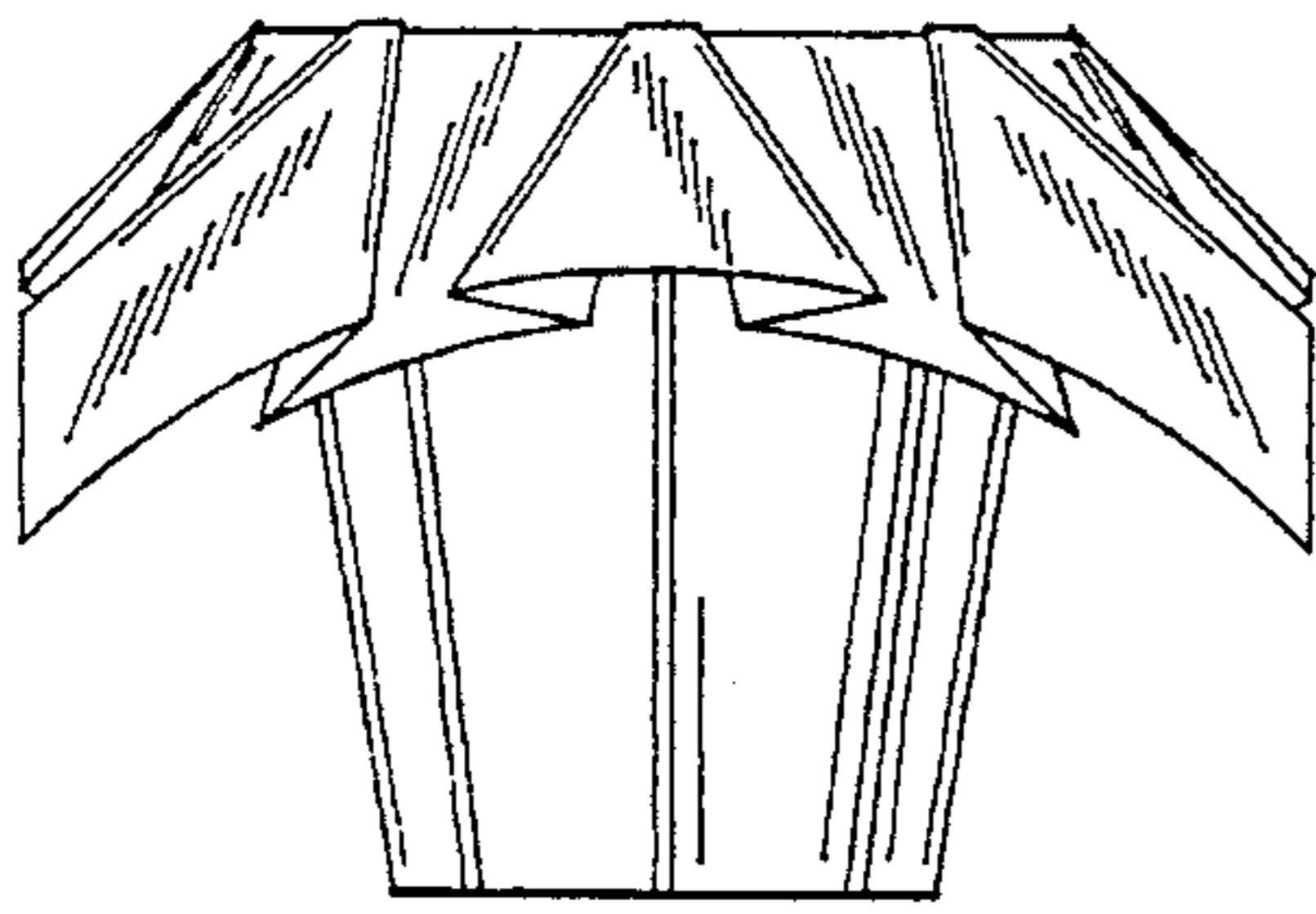

FIG. 7

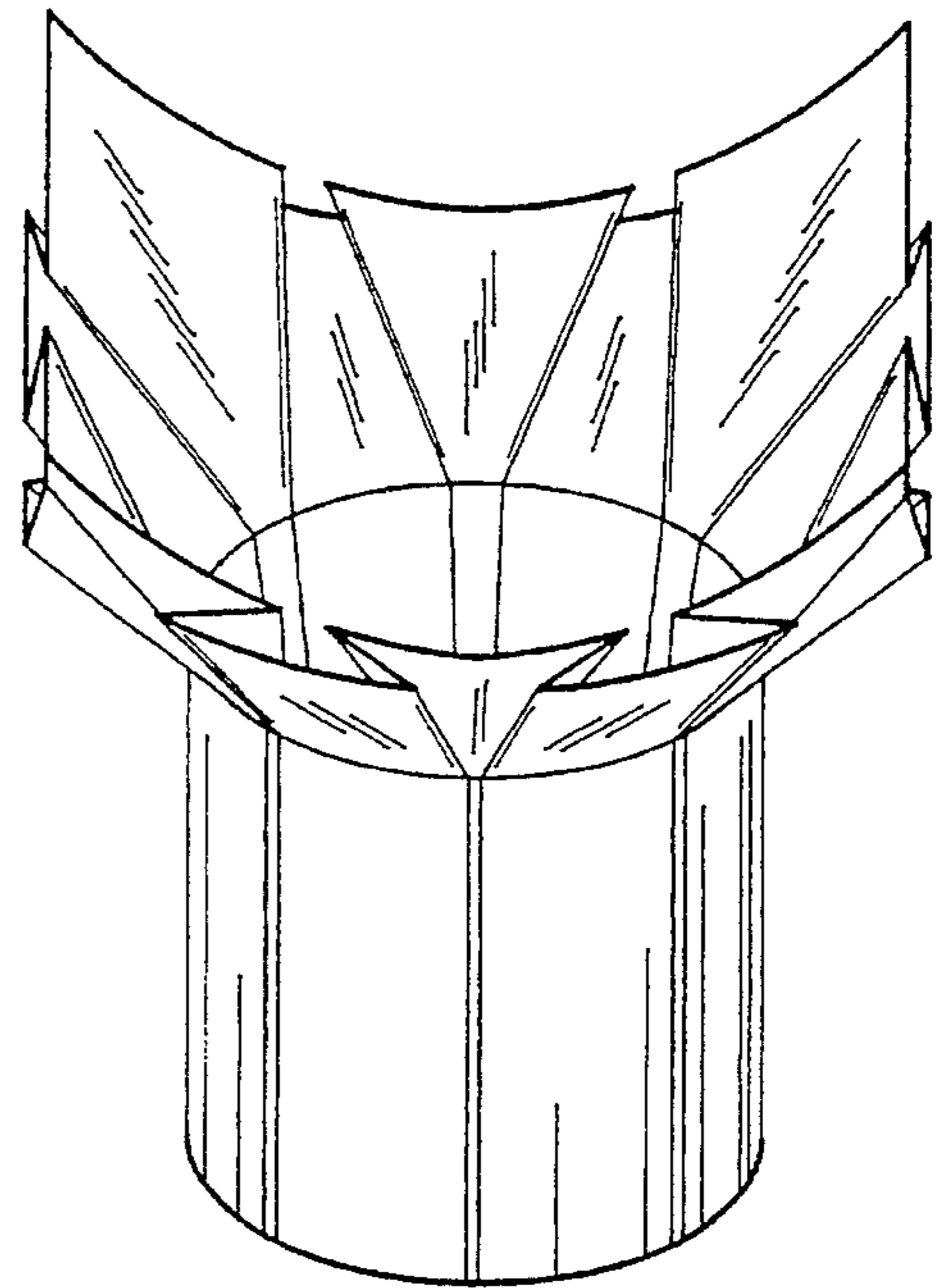

FIG. 8

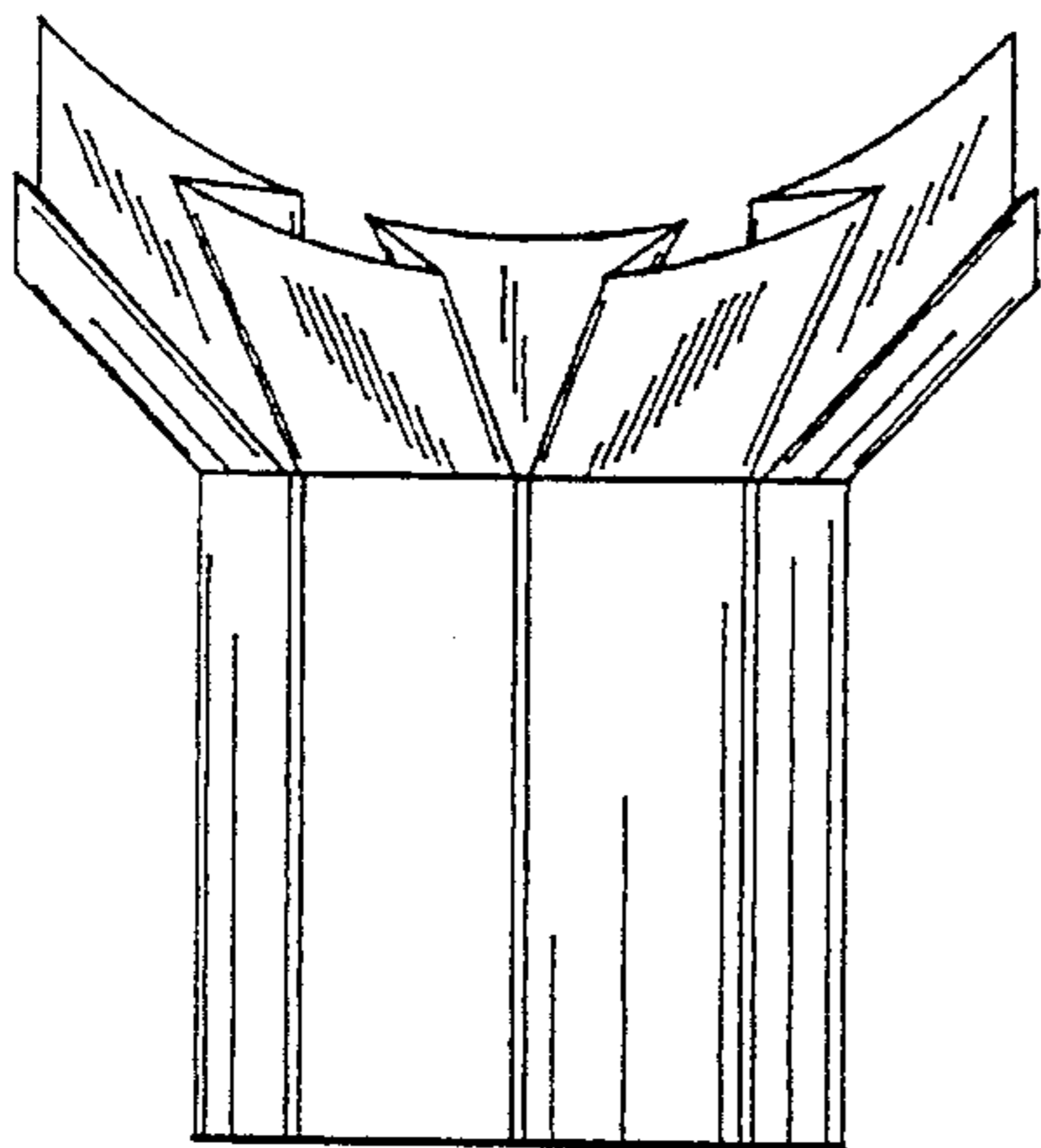

FIG. 9

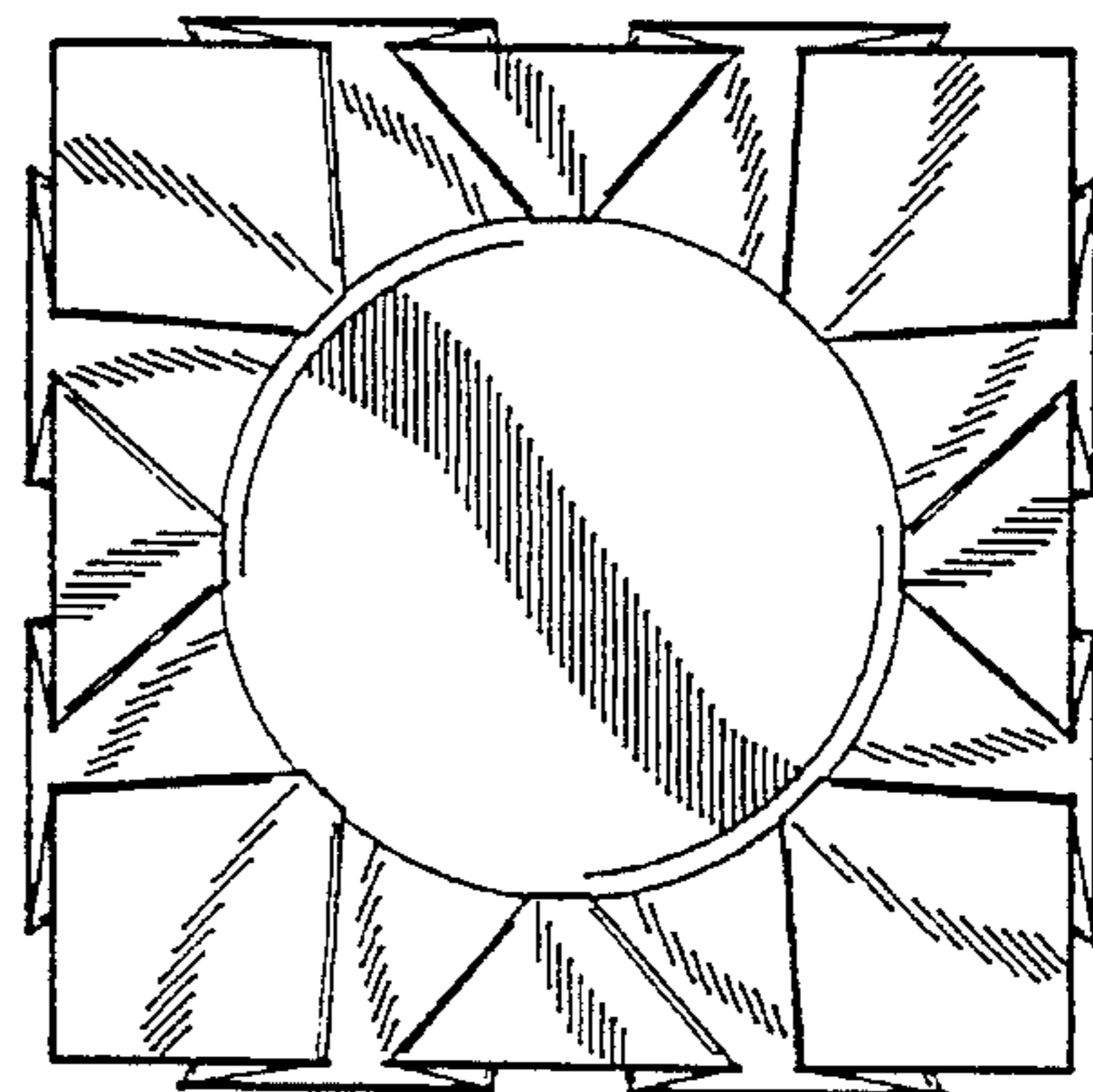

FIG. 10

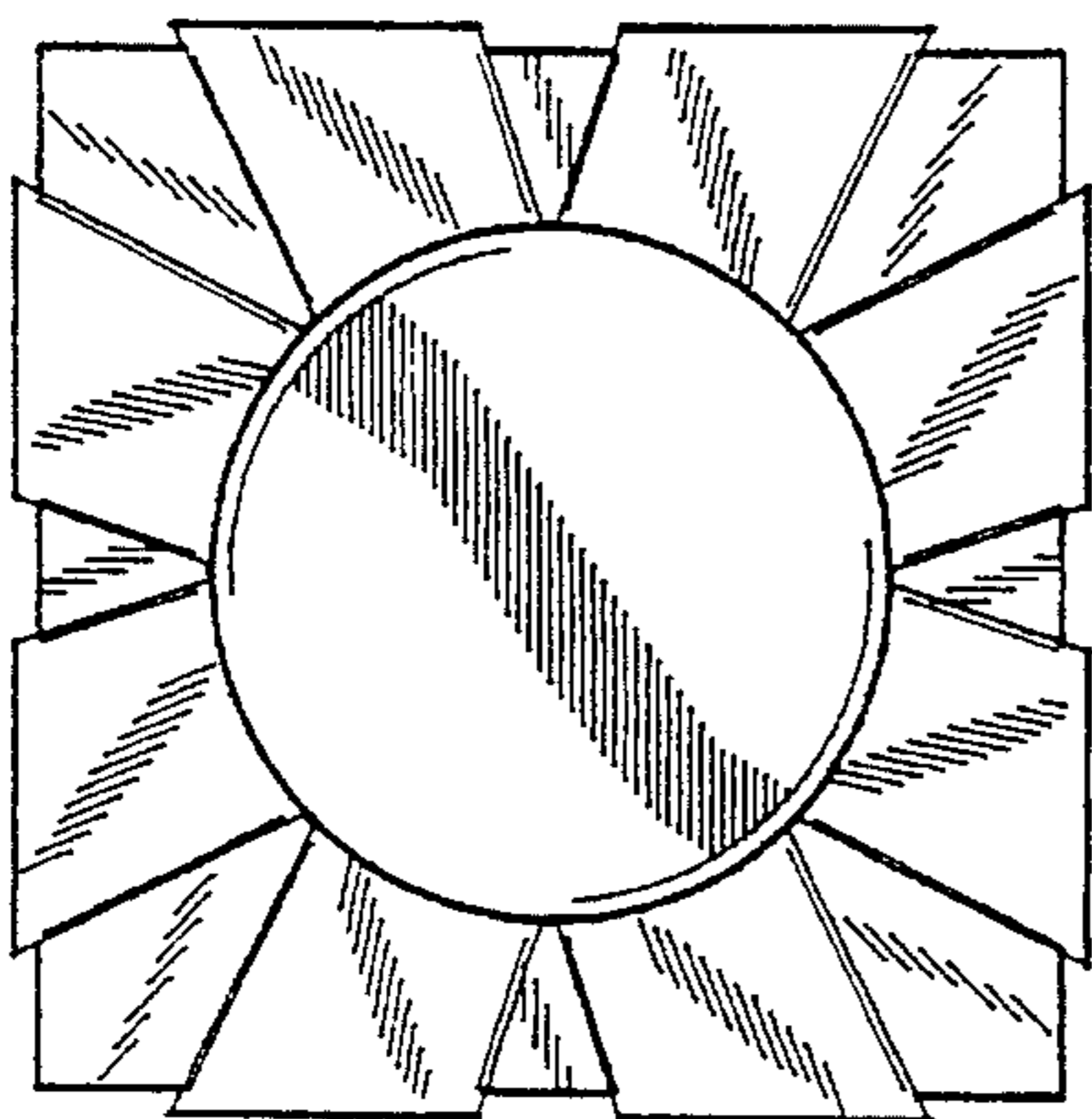

FIG. 11

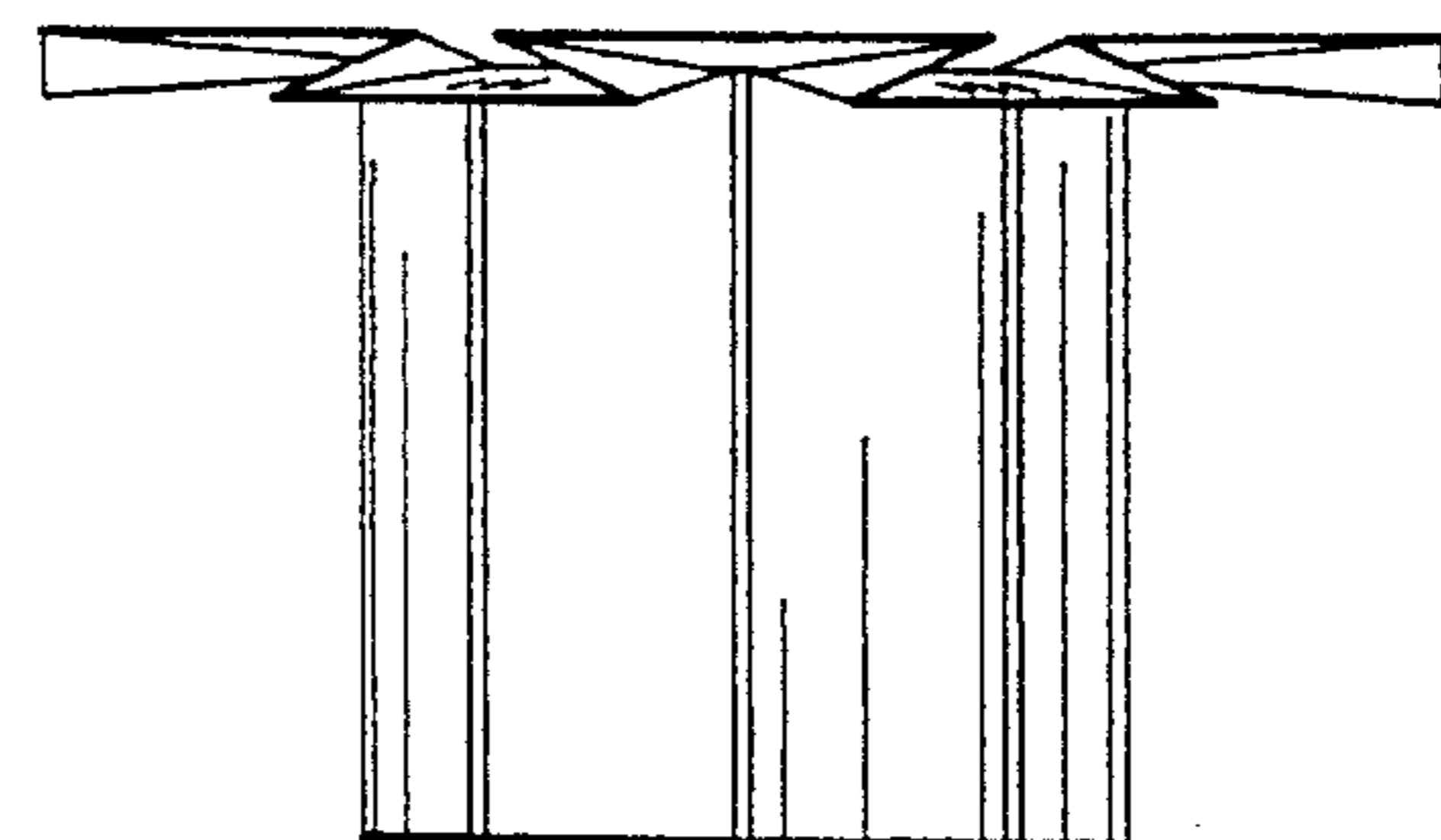

FIG. 12

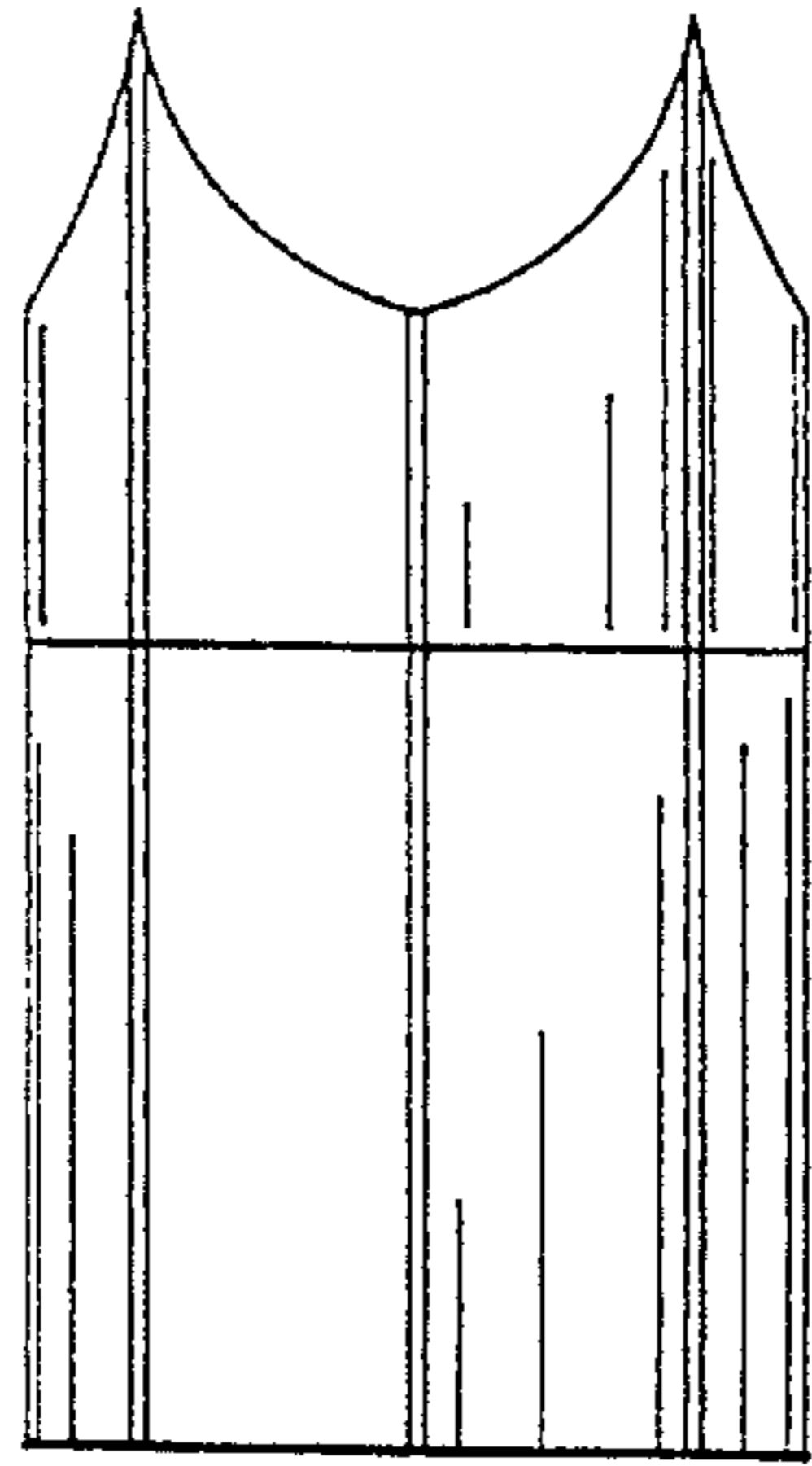

FIG. 13

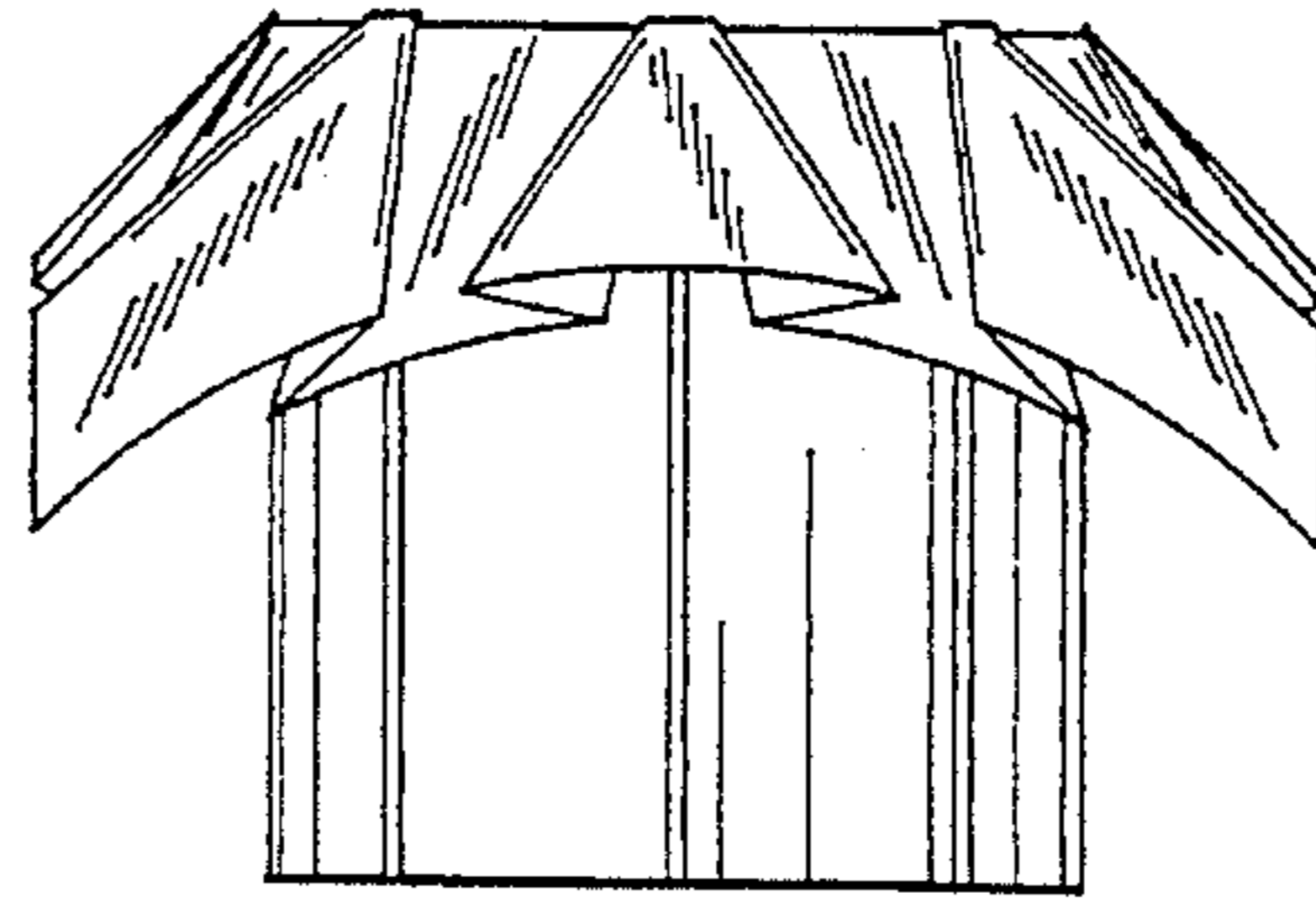

FIG. 14

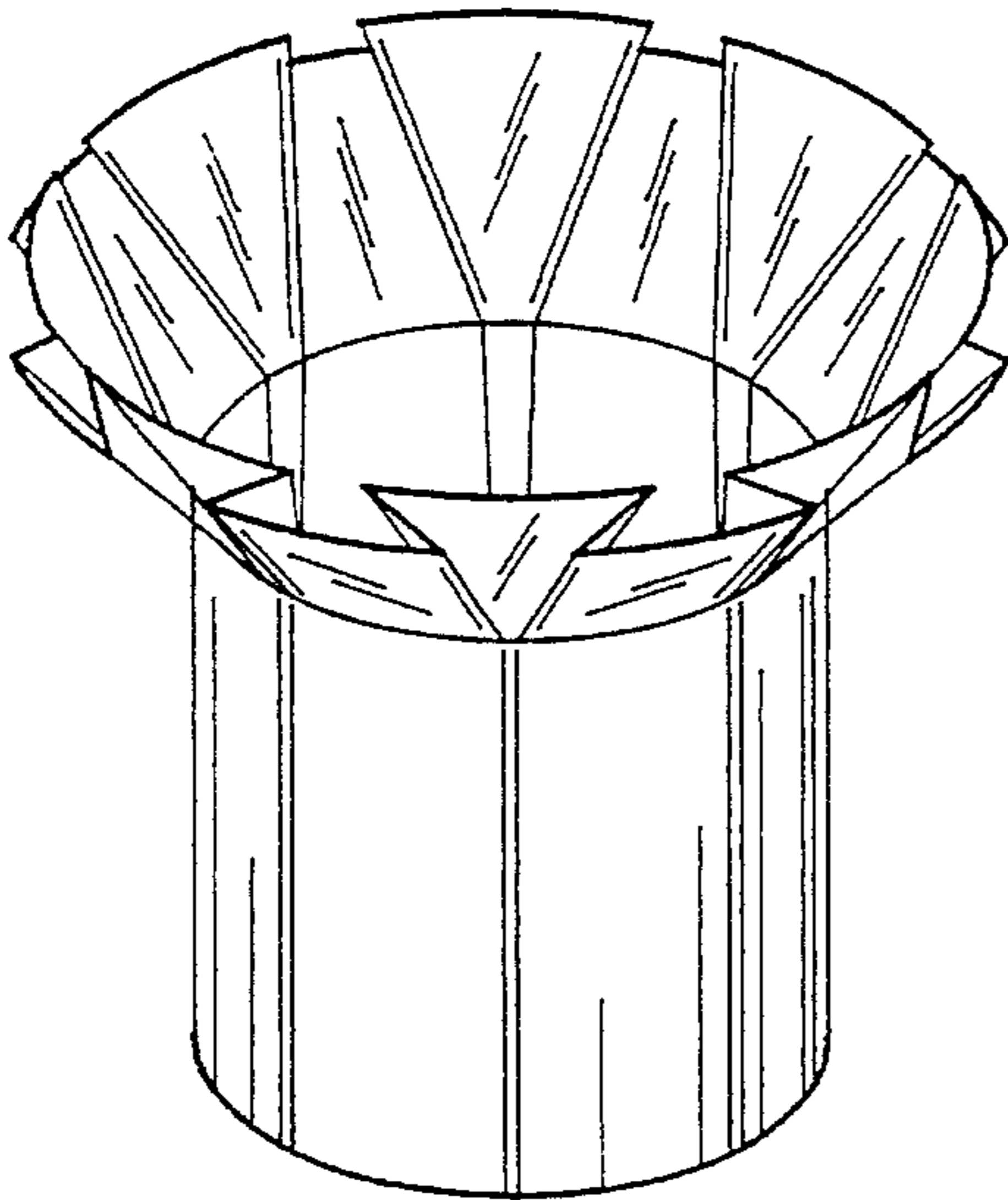

FIG. 15

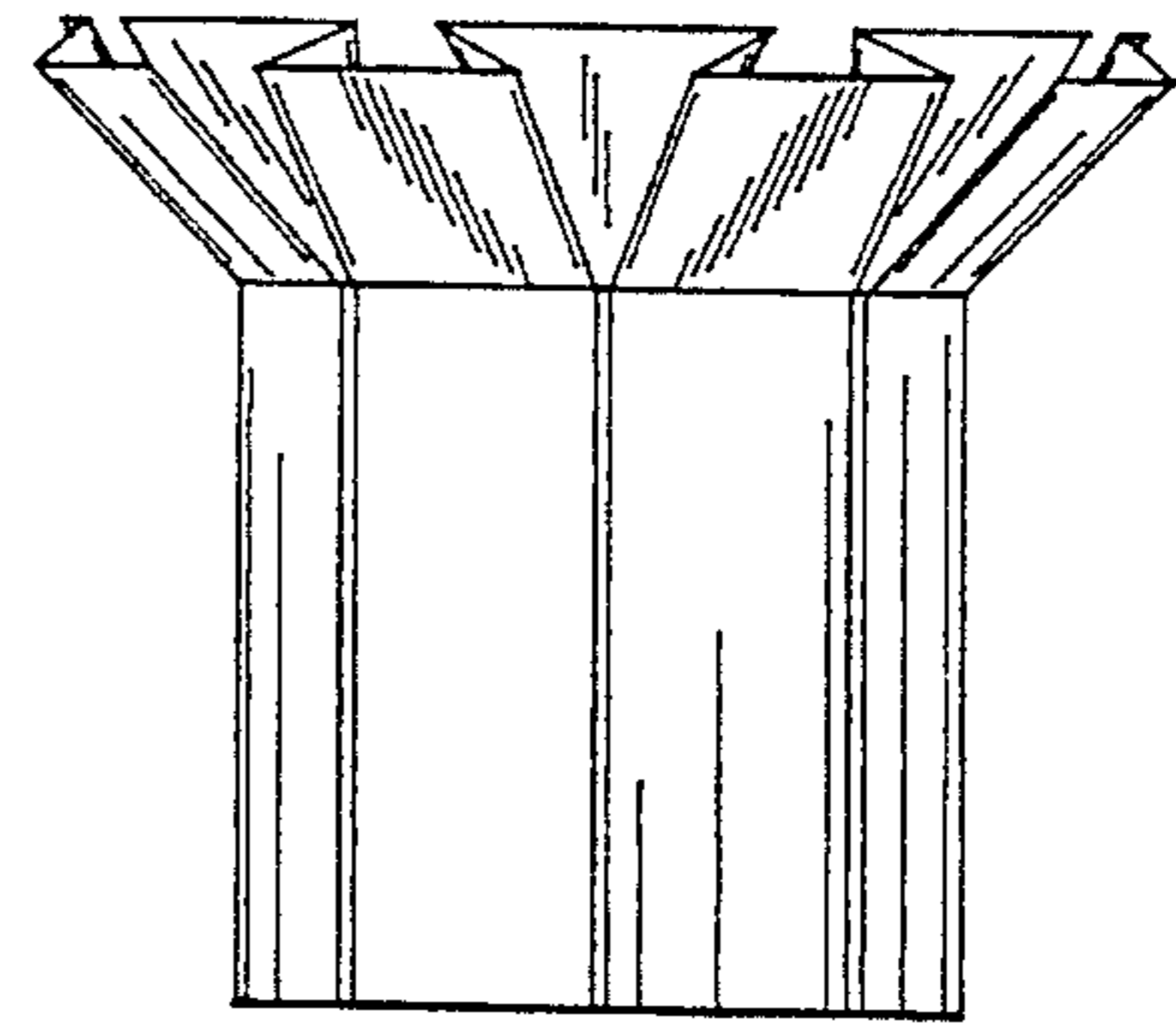

FIG. 16

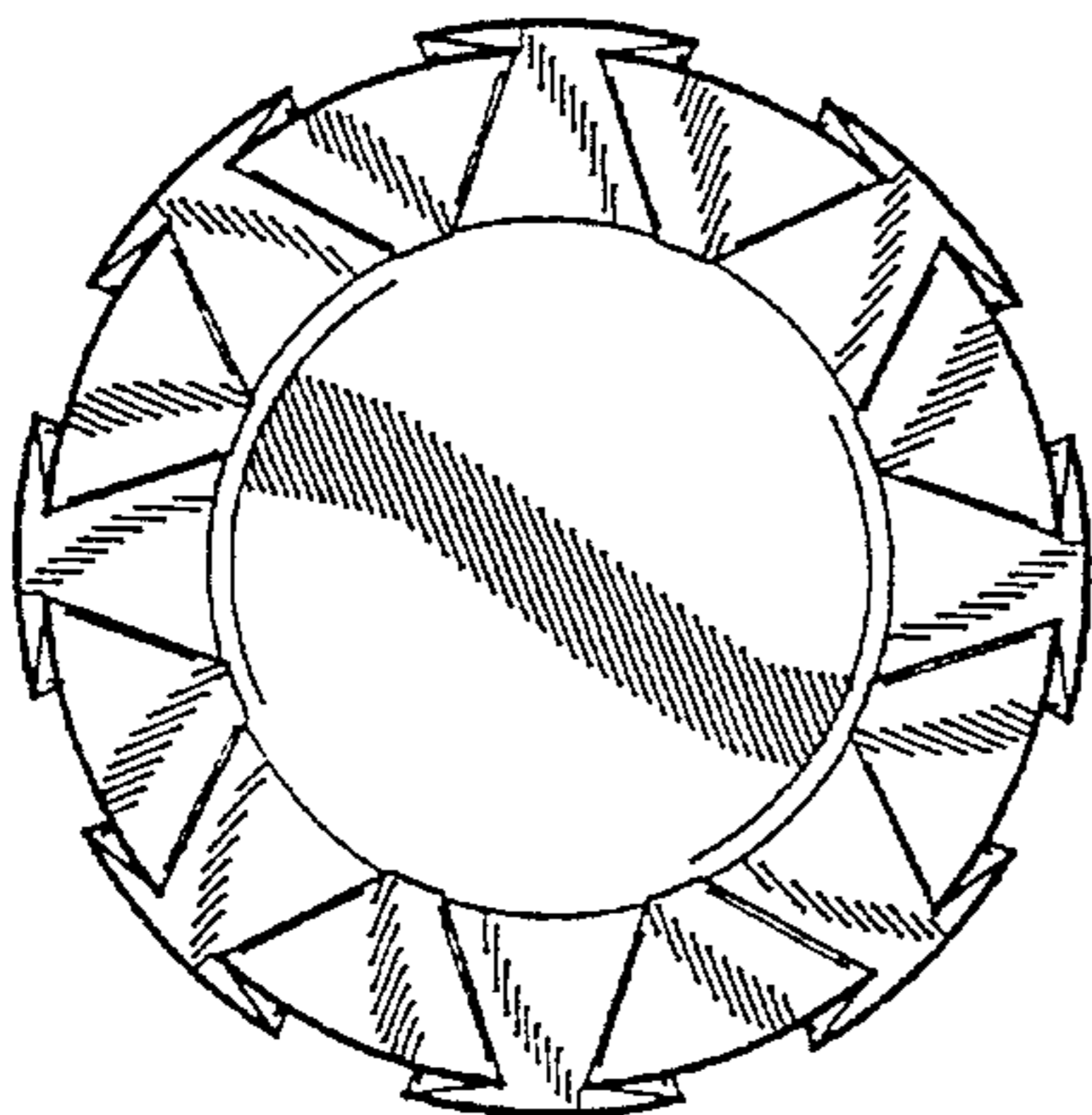

FIG. 17

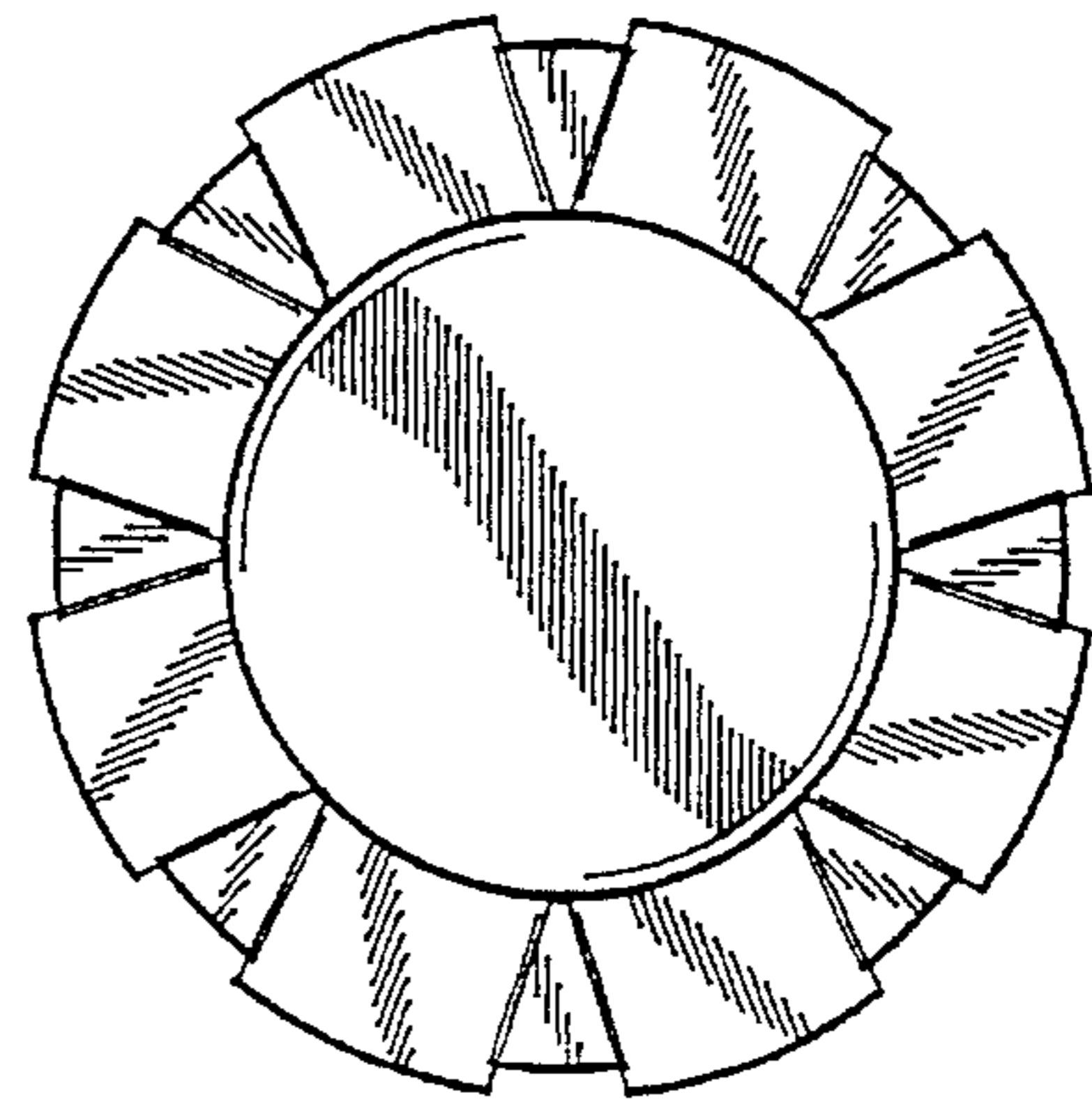
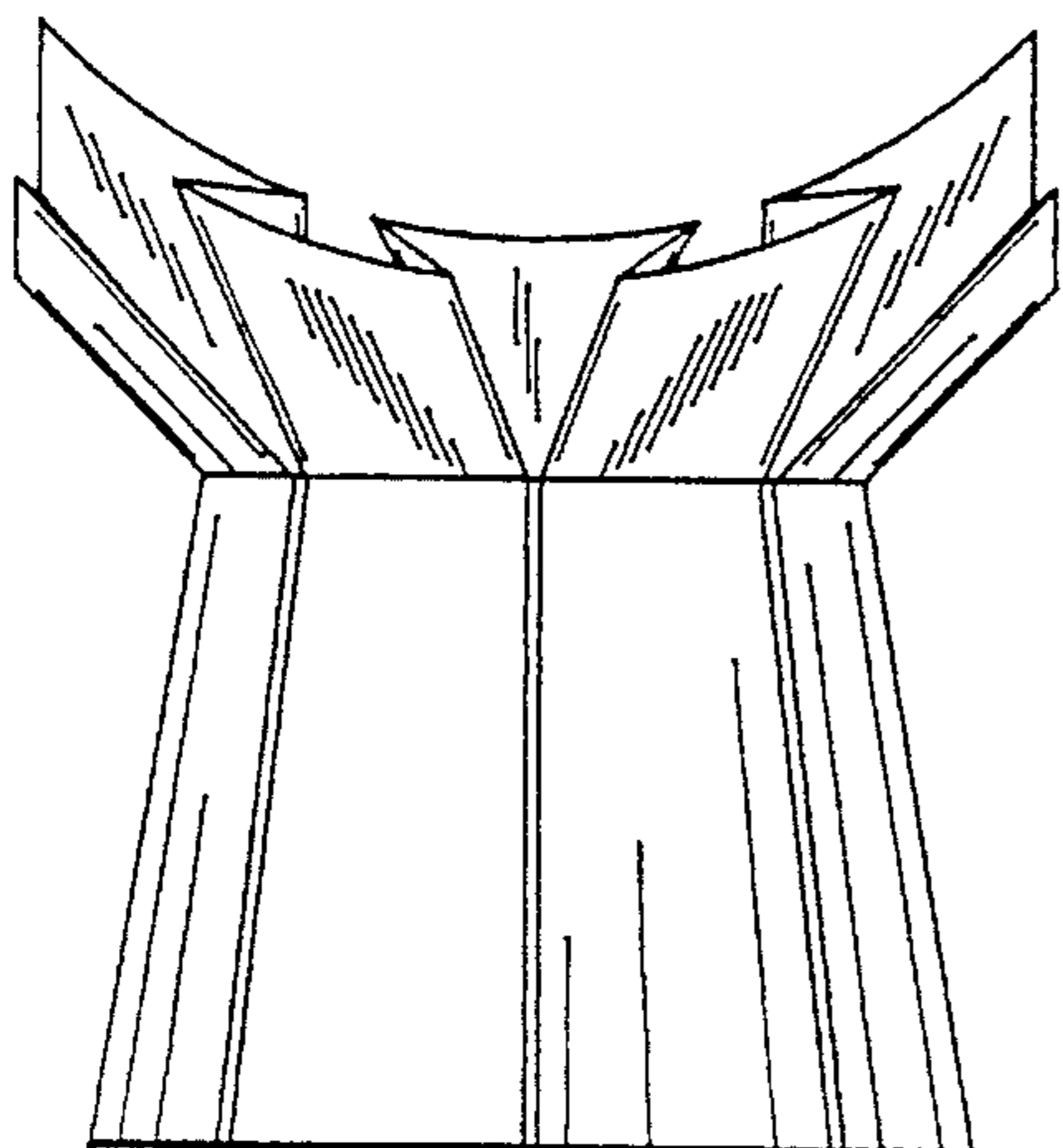
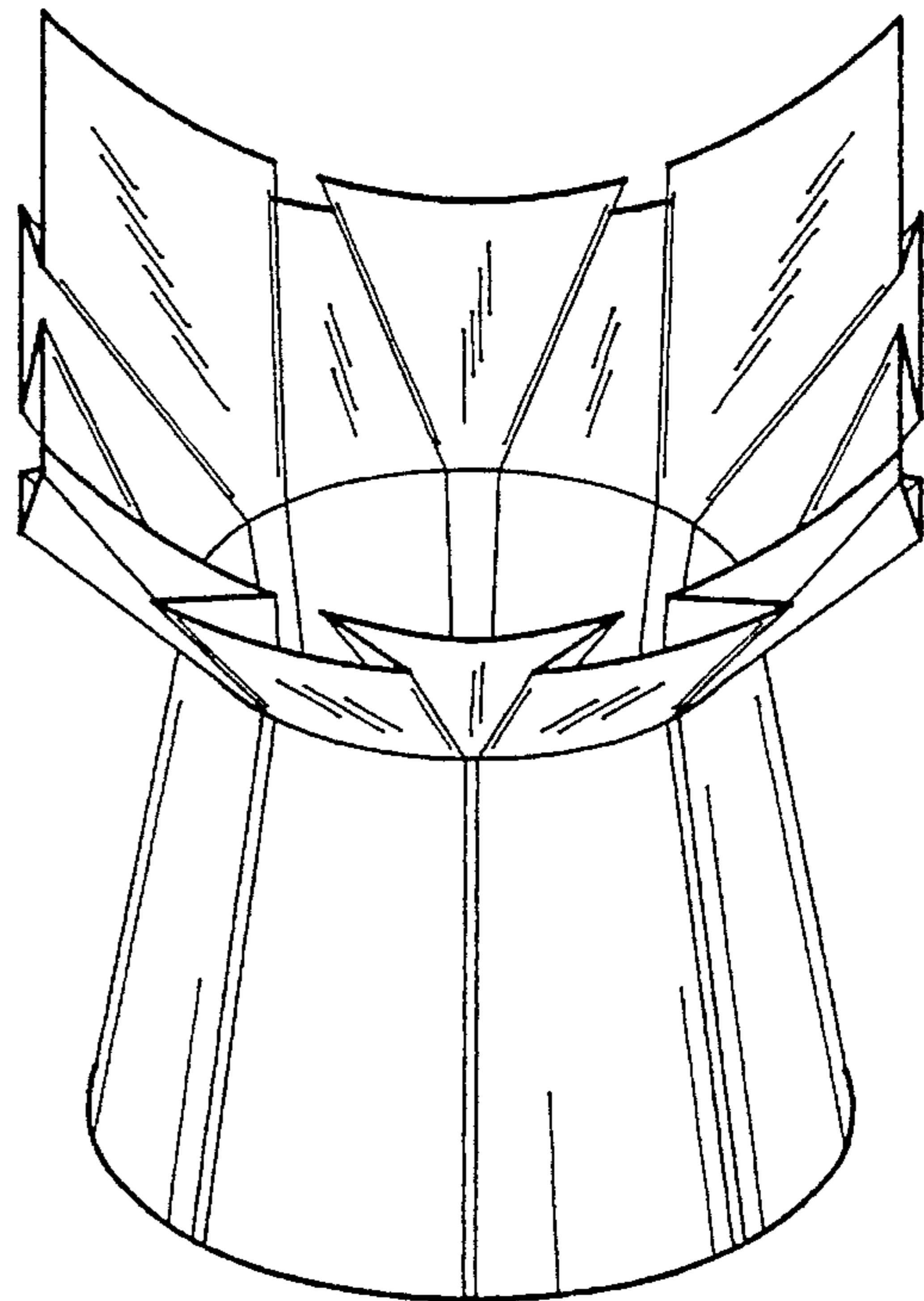
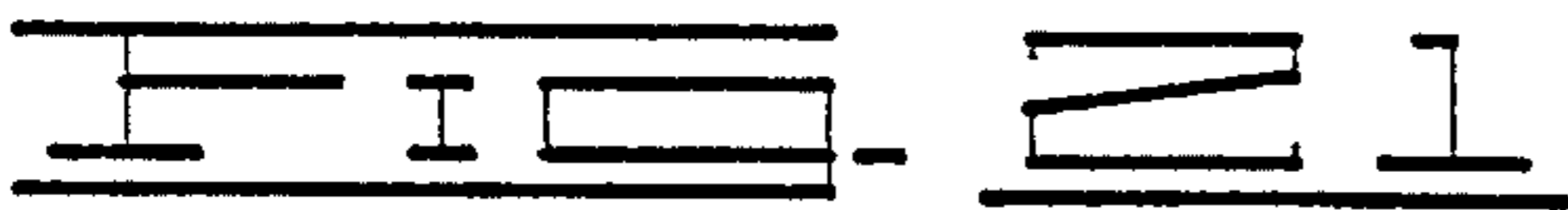
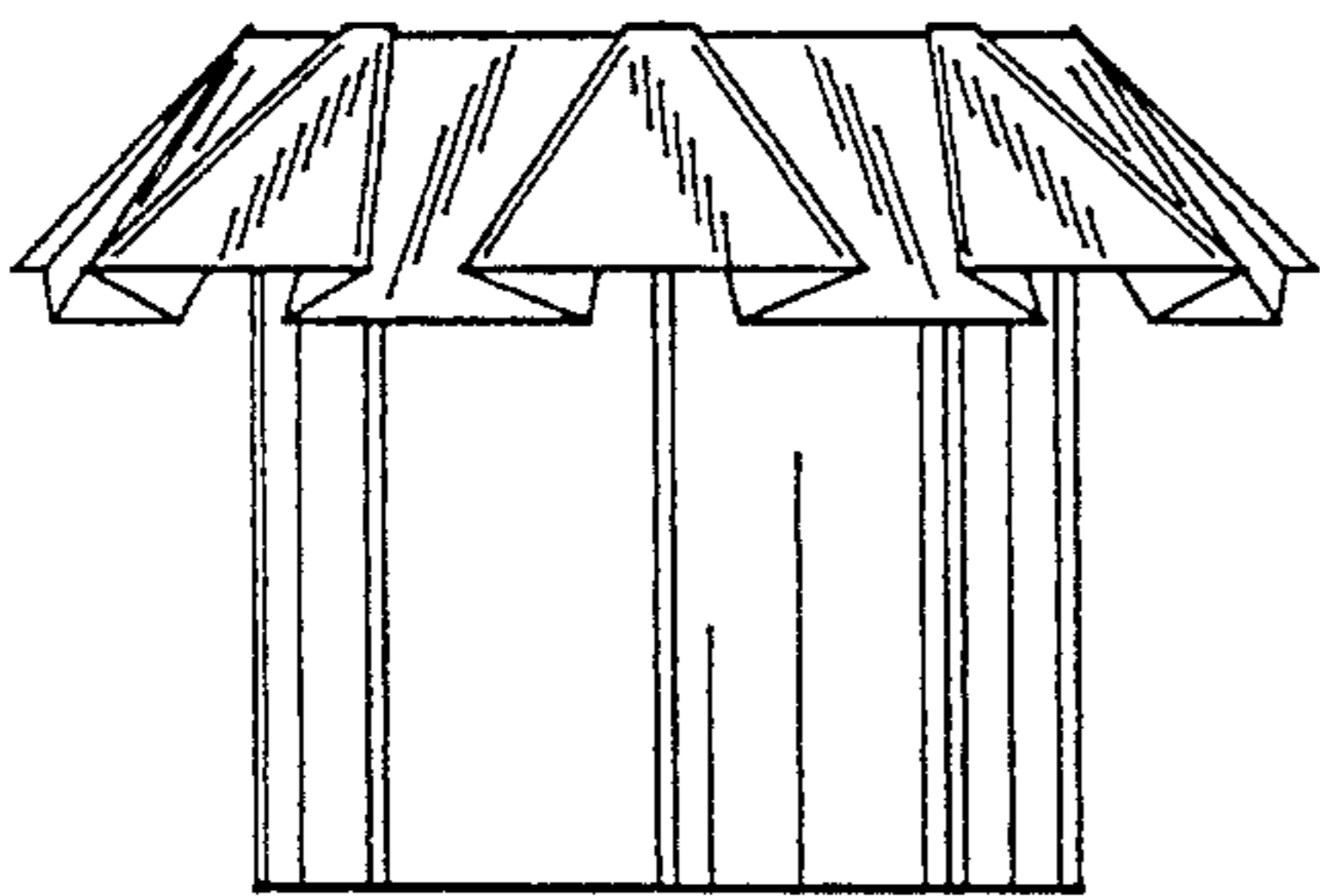
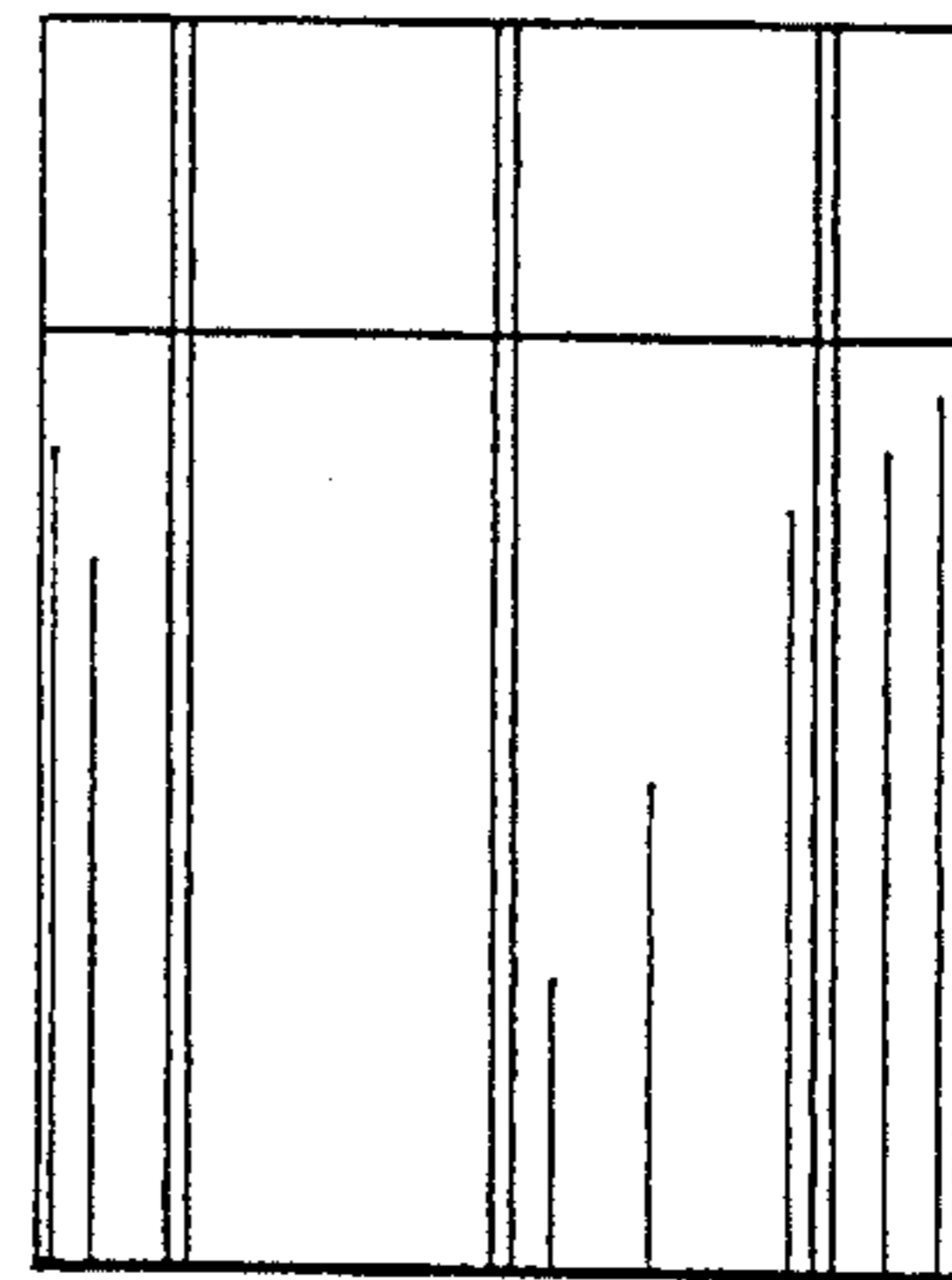
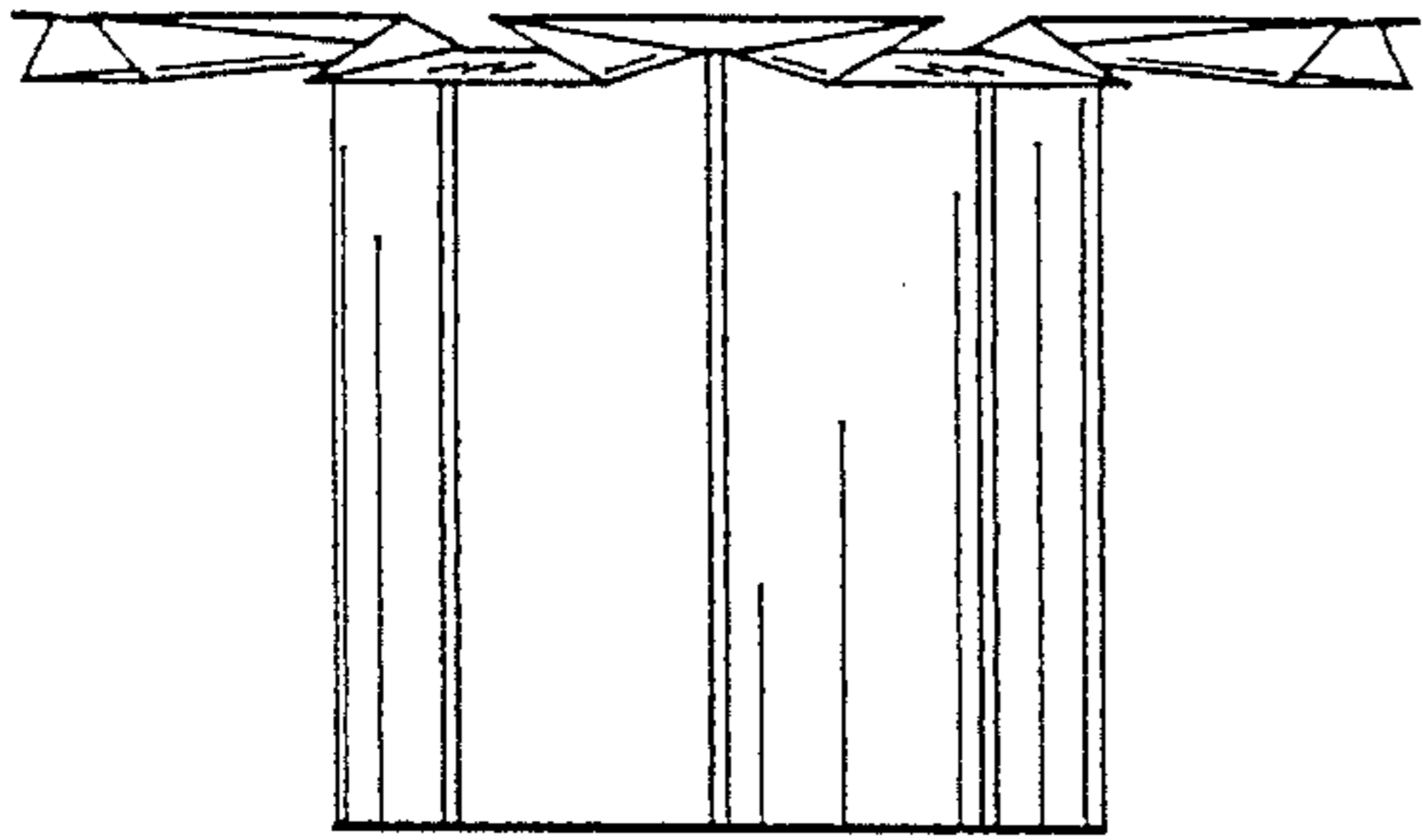

FIG. 18



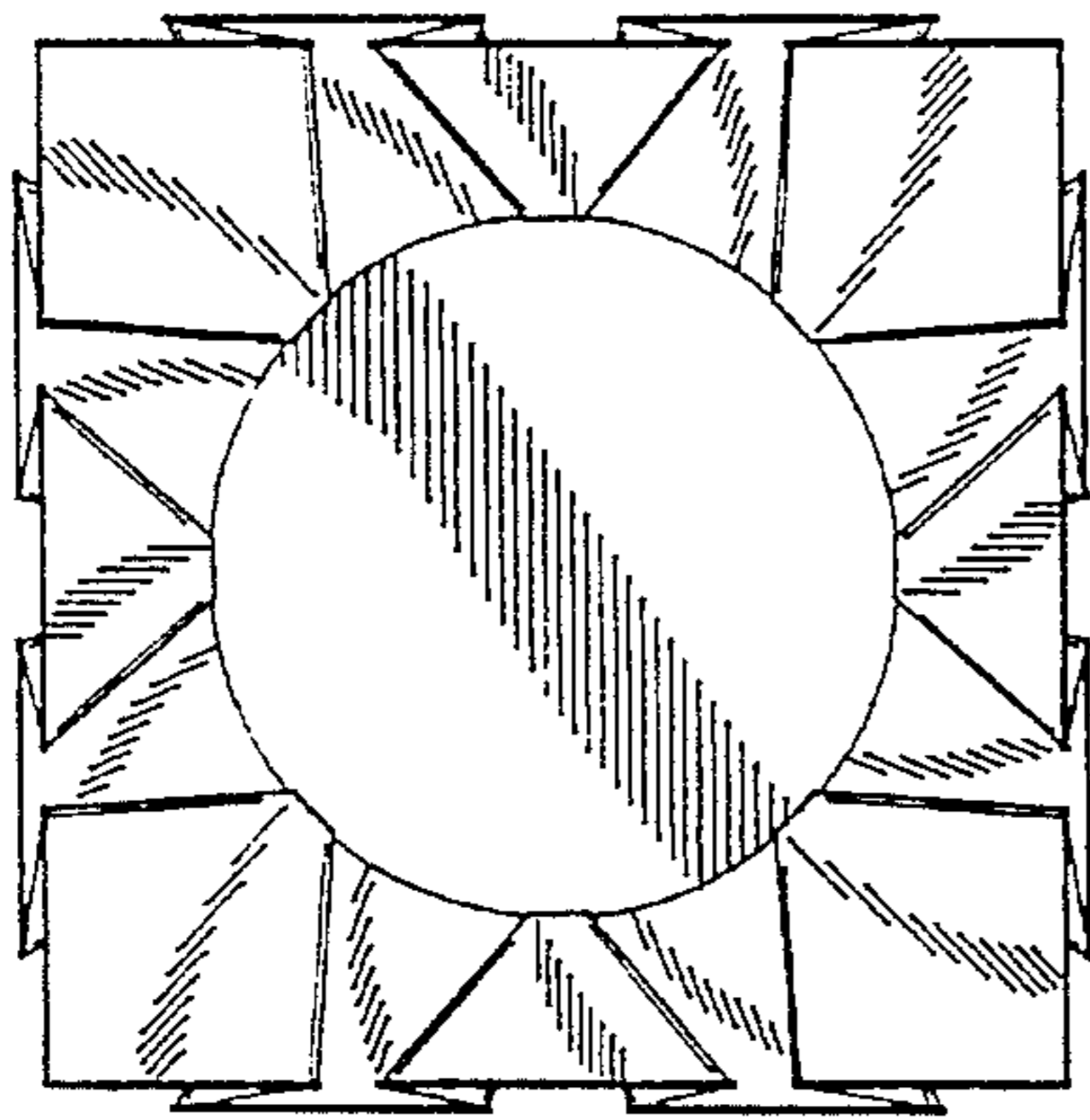

FIG. 24

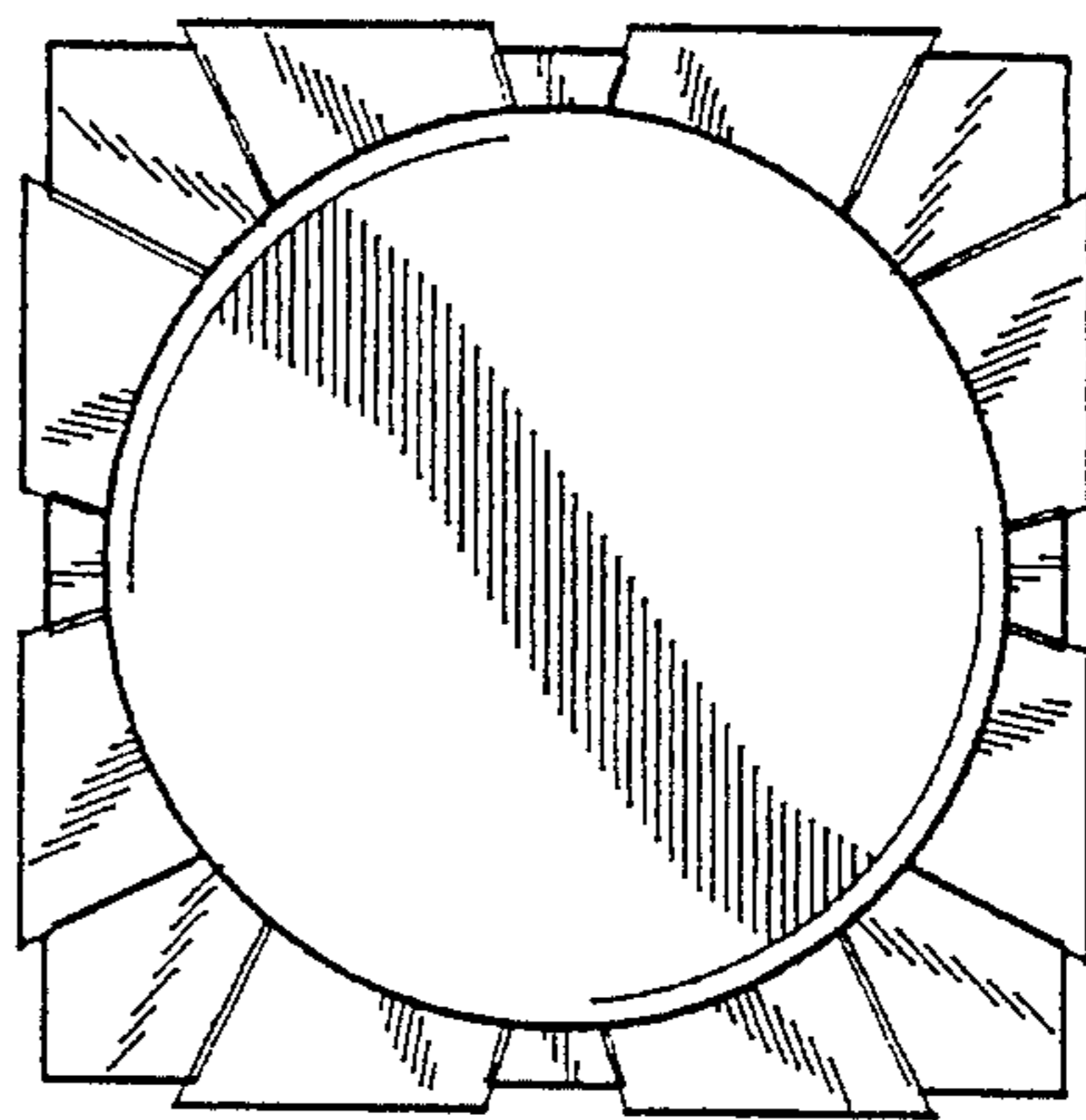

FIG. 25

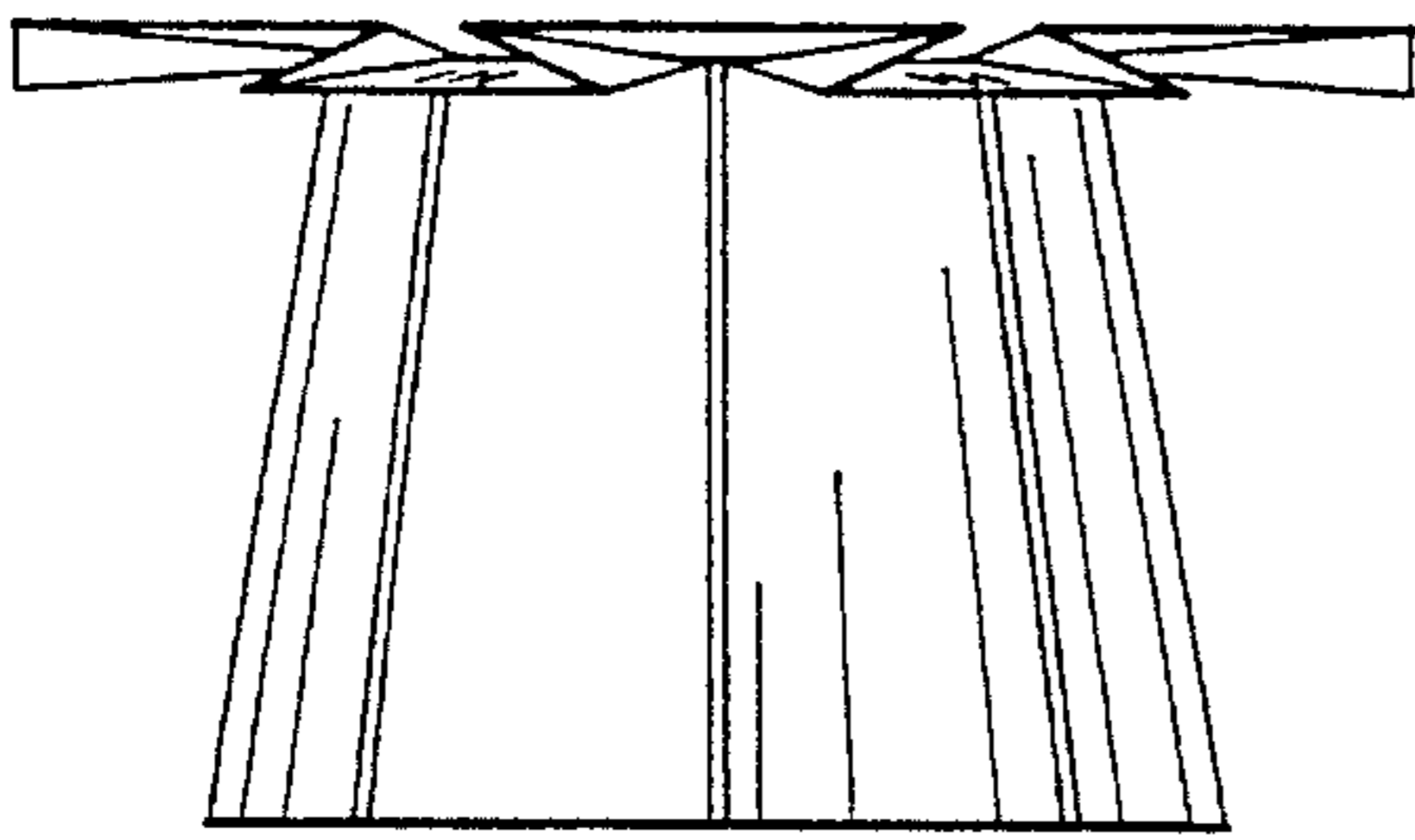

FIG. 26

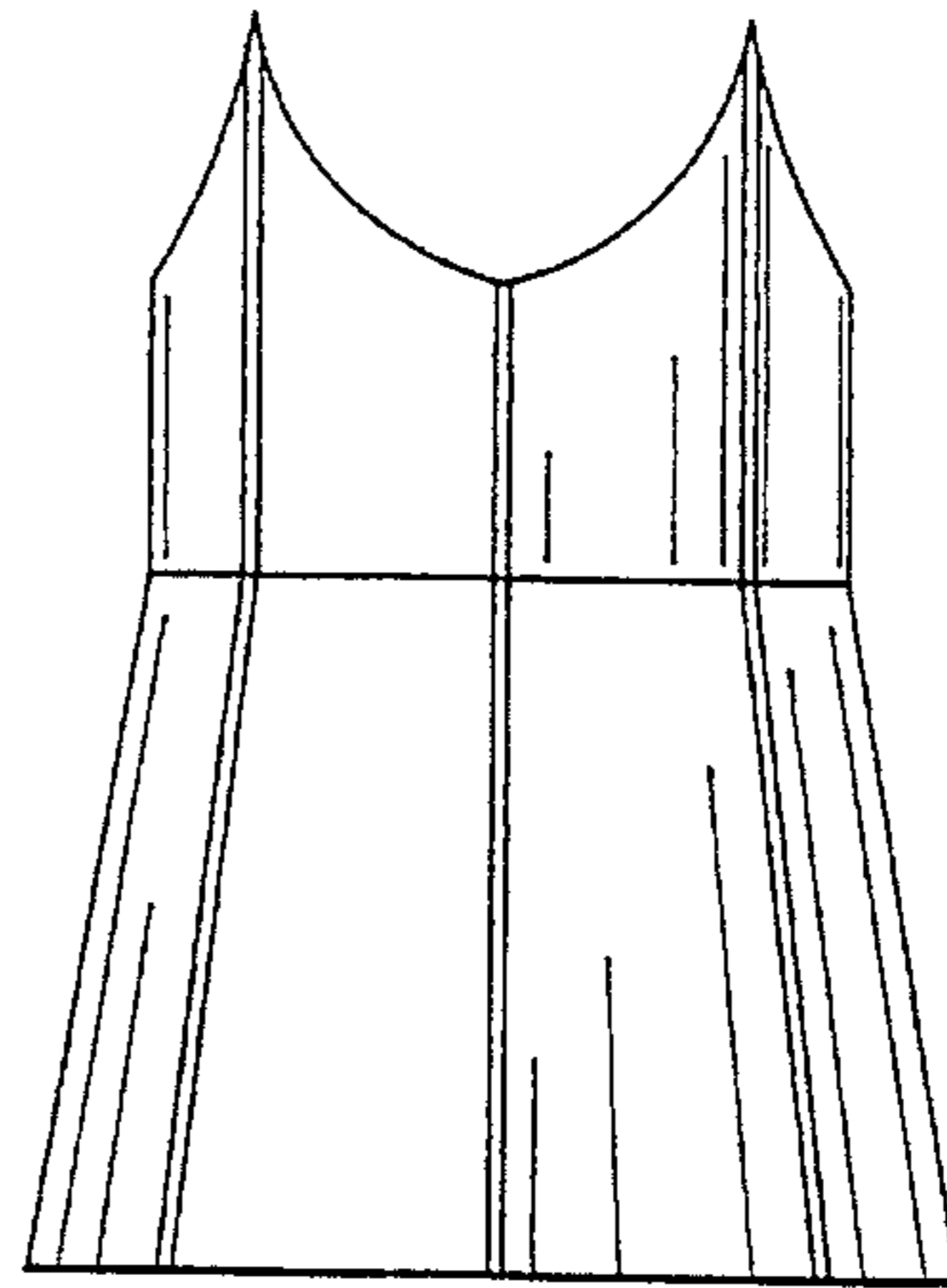

FIG. 27

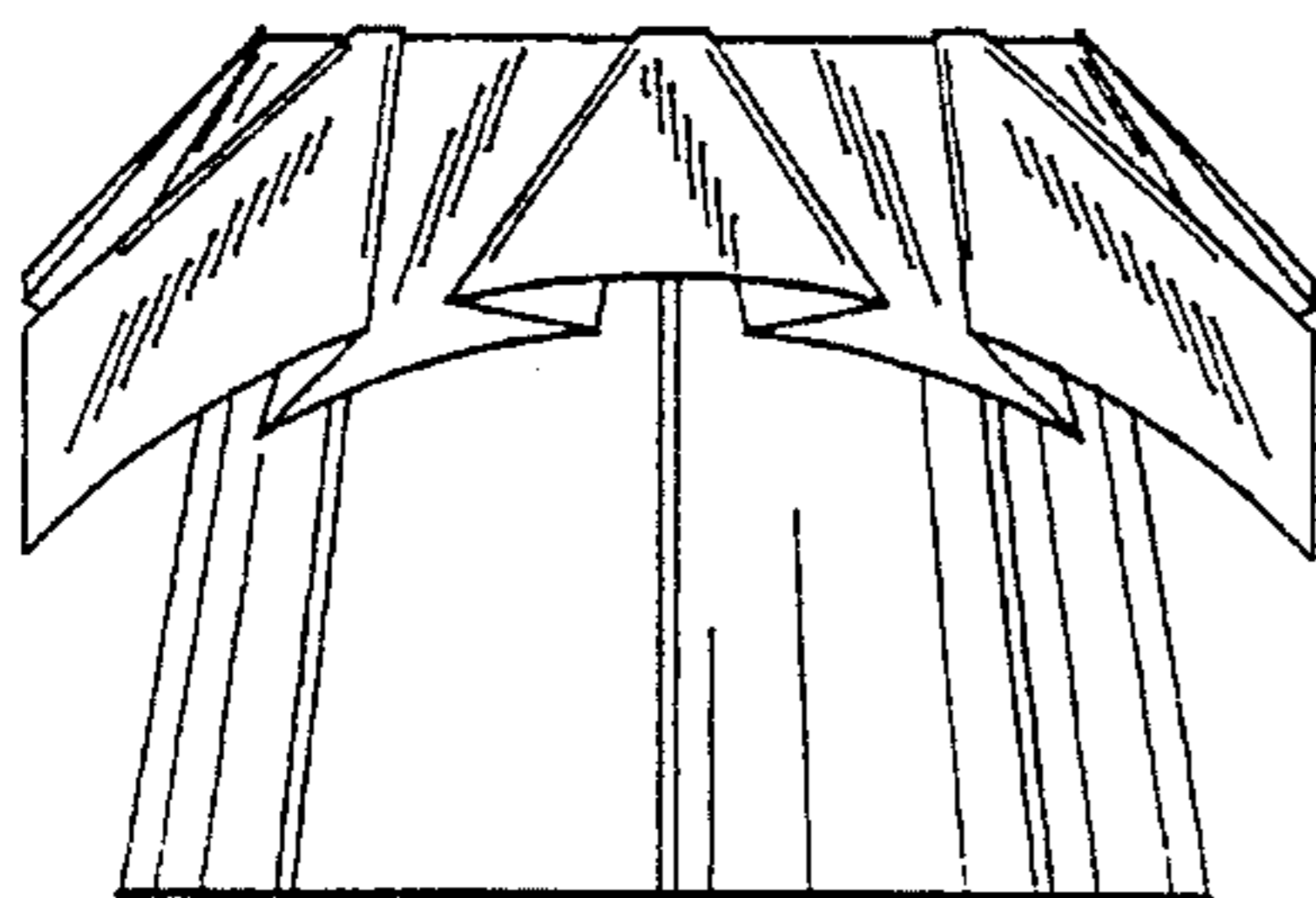

FIG. 28

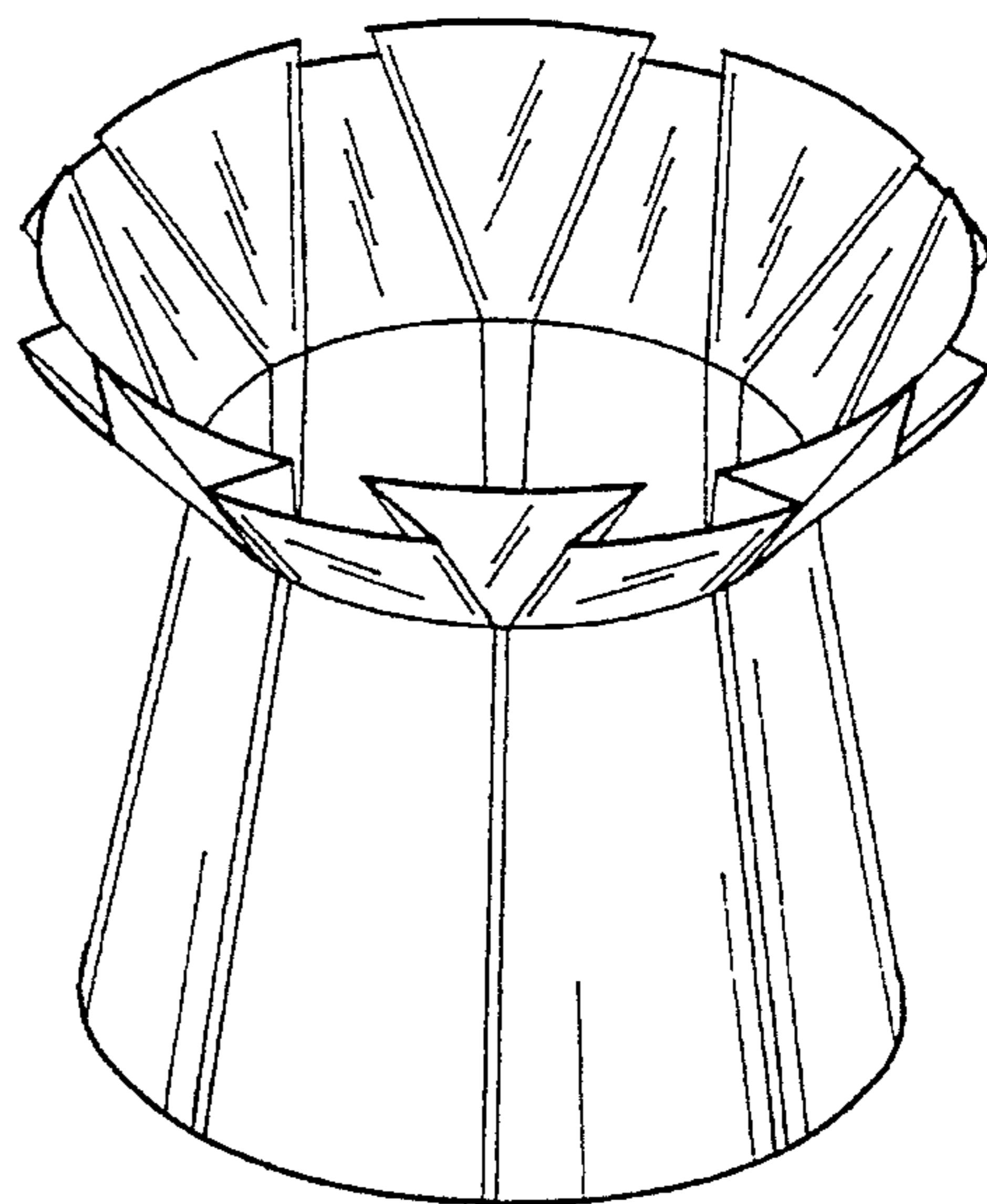

FIG. 29

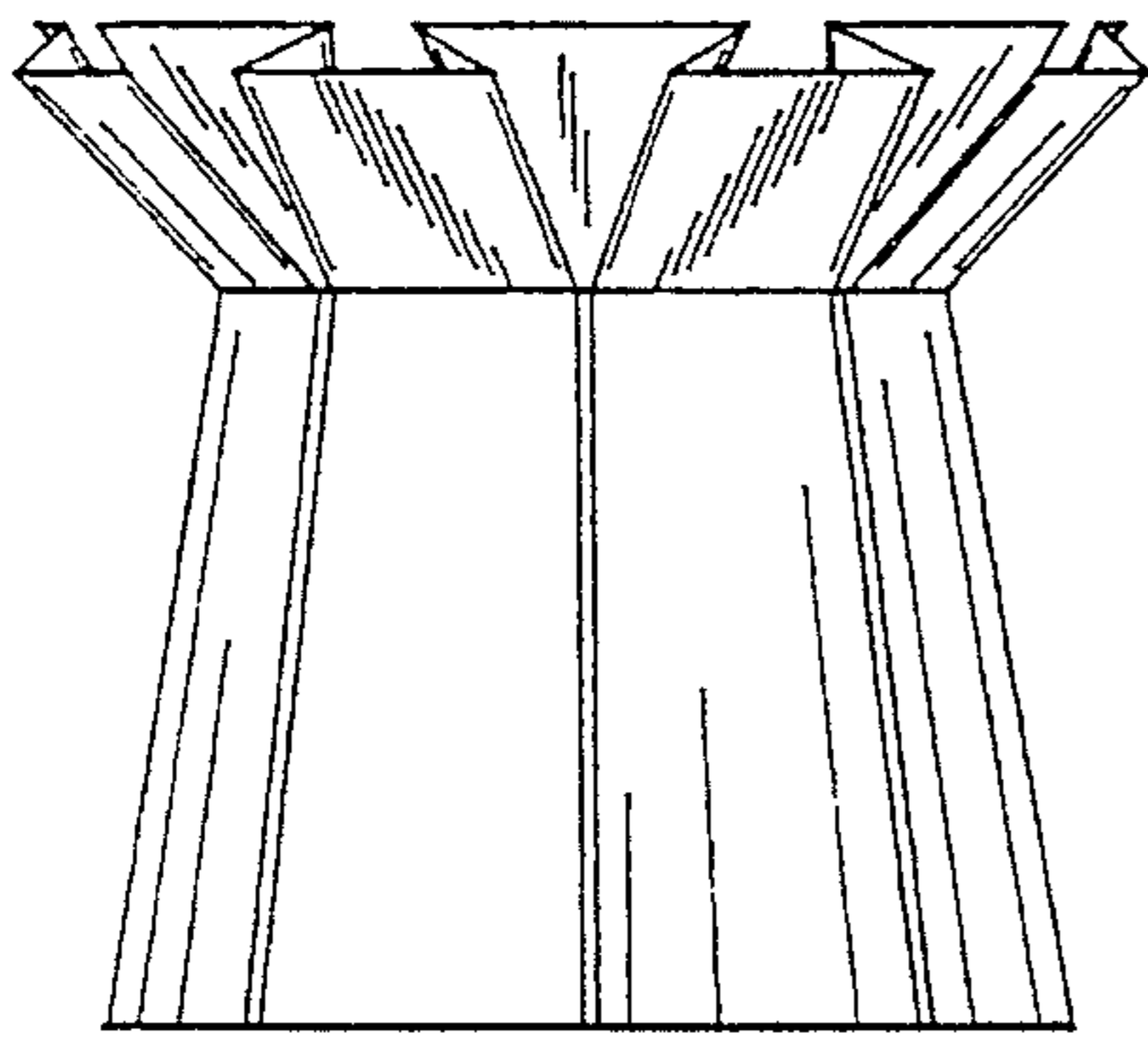

FIG. 30

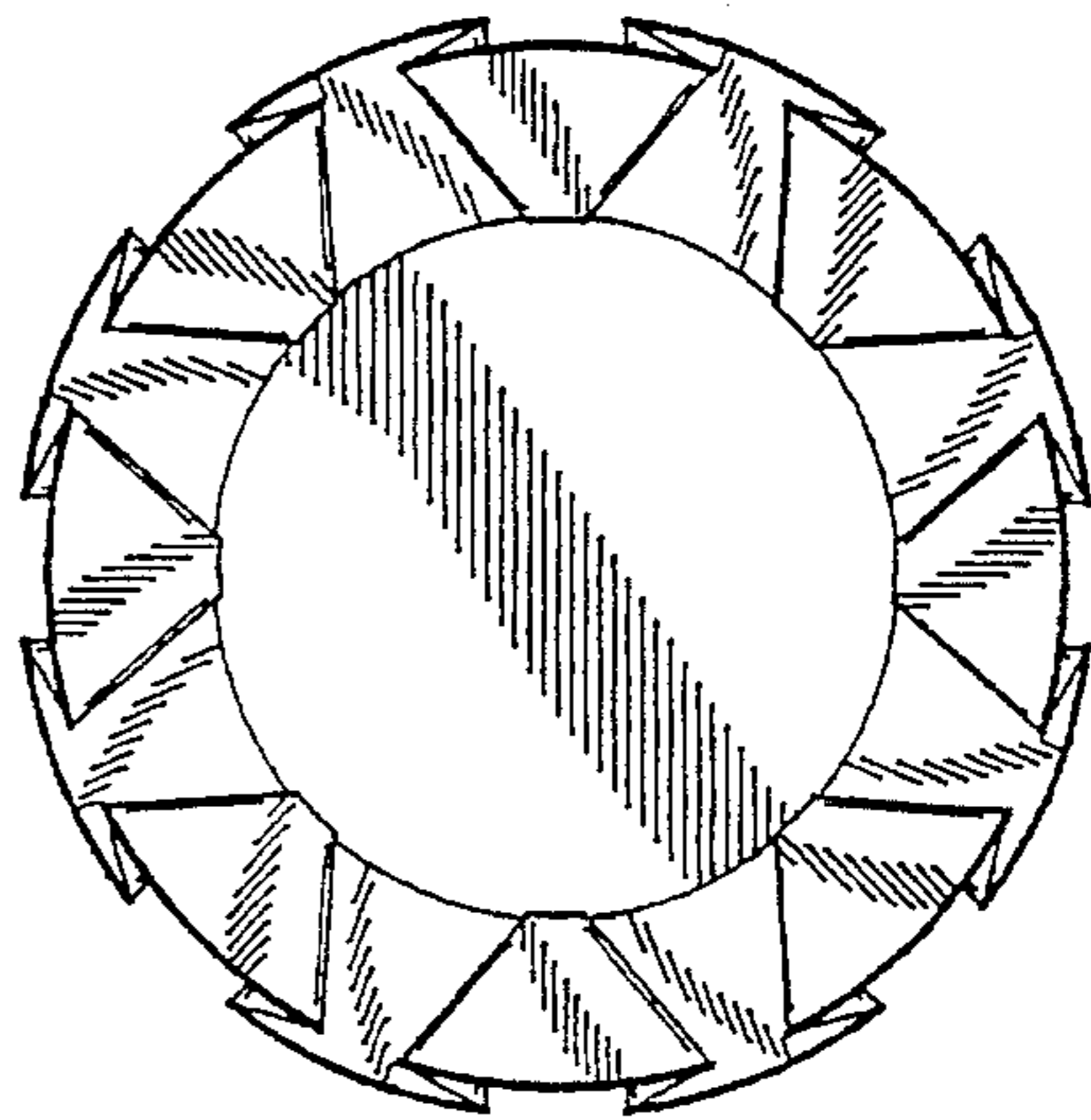

FIG. 31

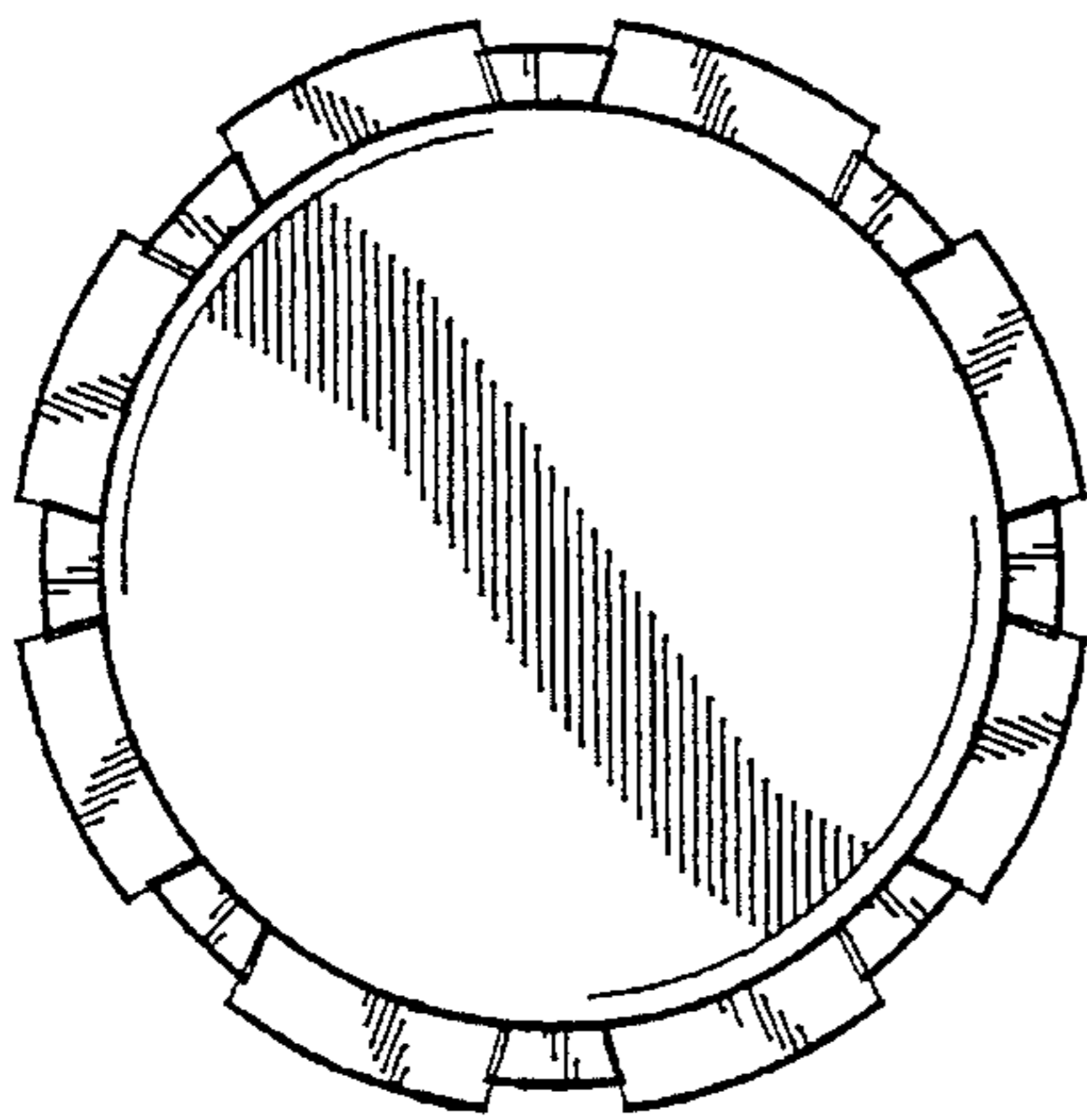

FIG. 32

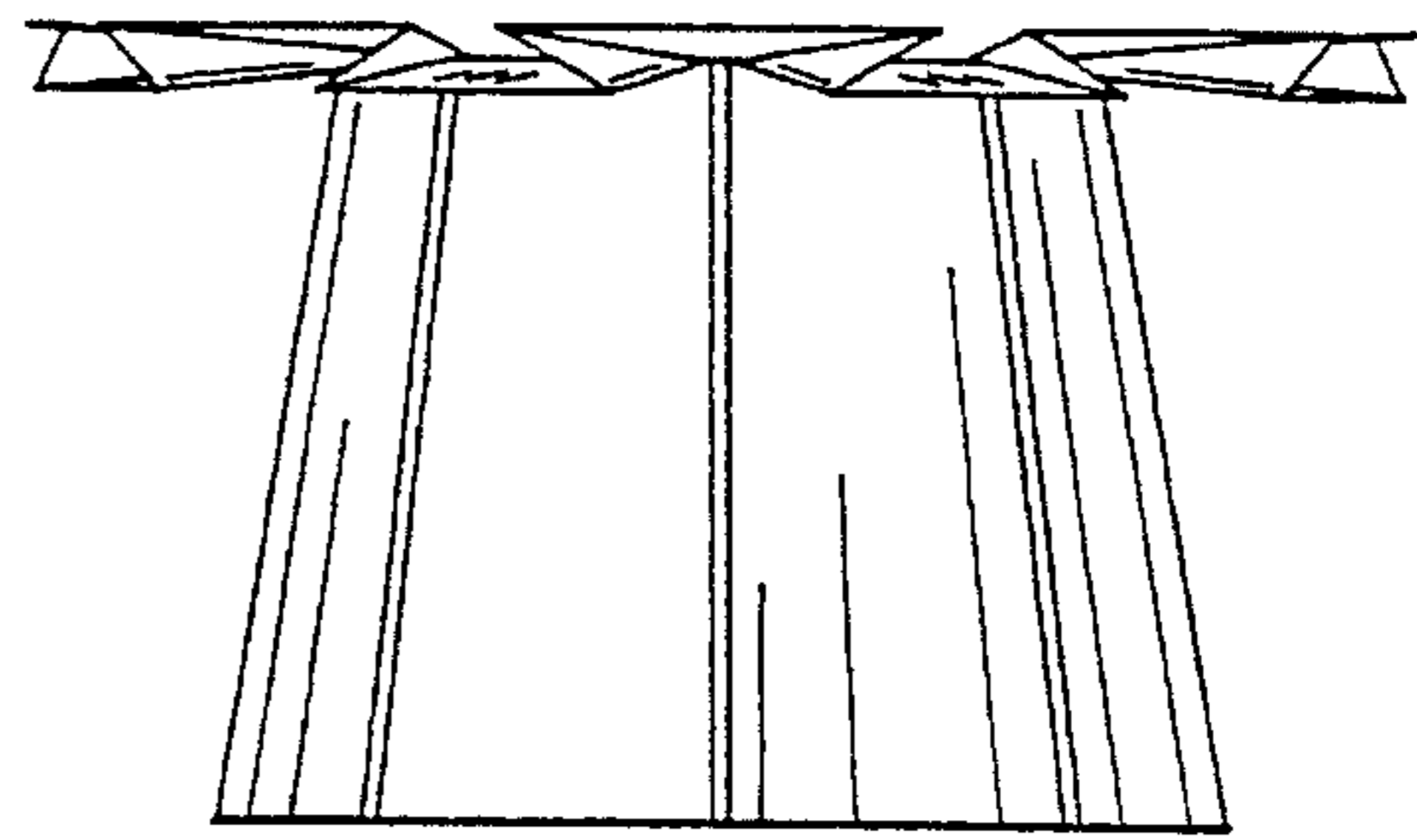

FIG. 33

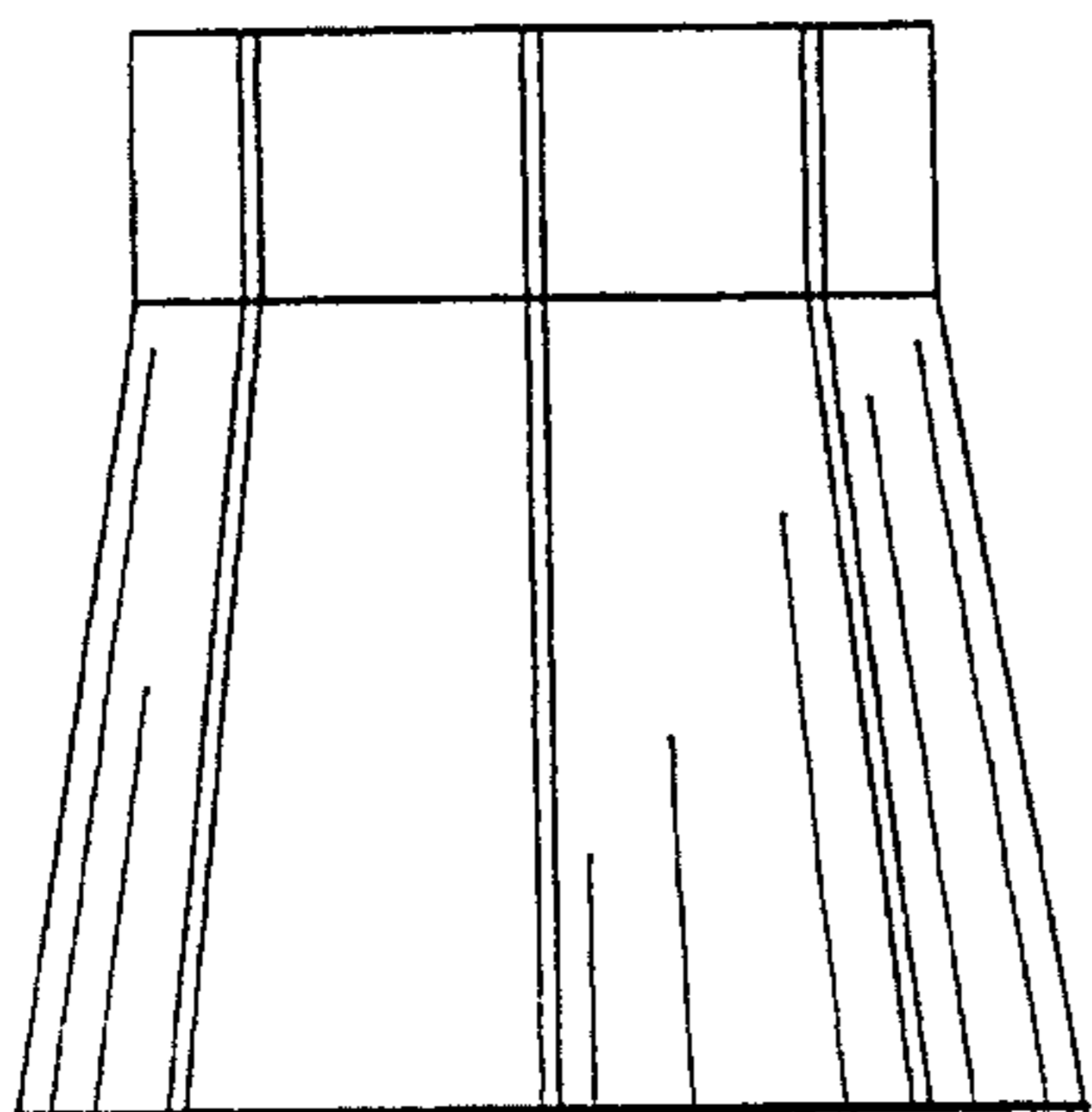

FIG. 34

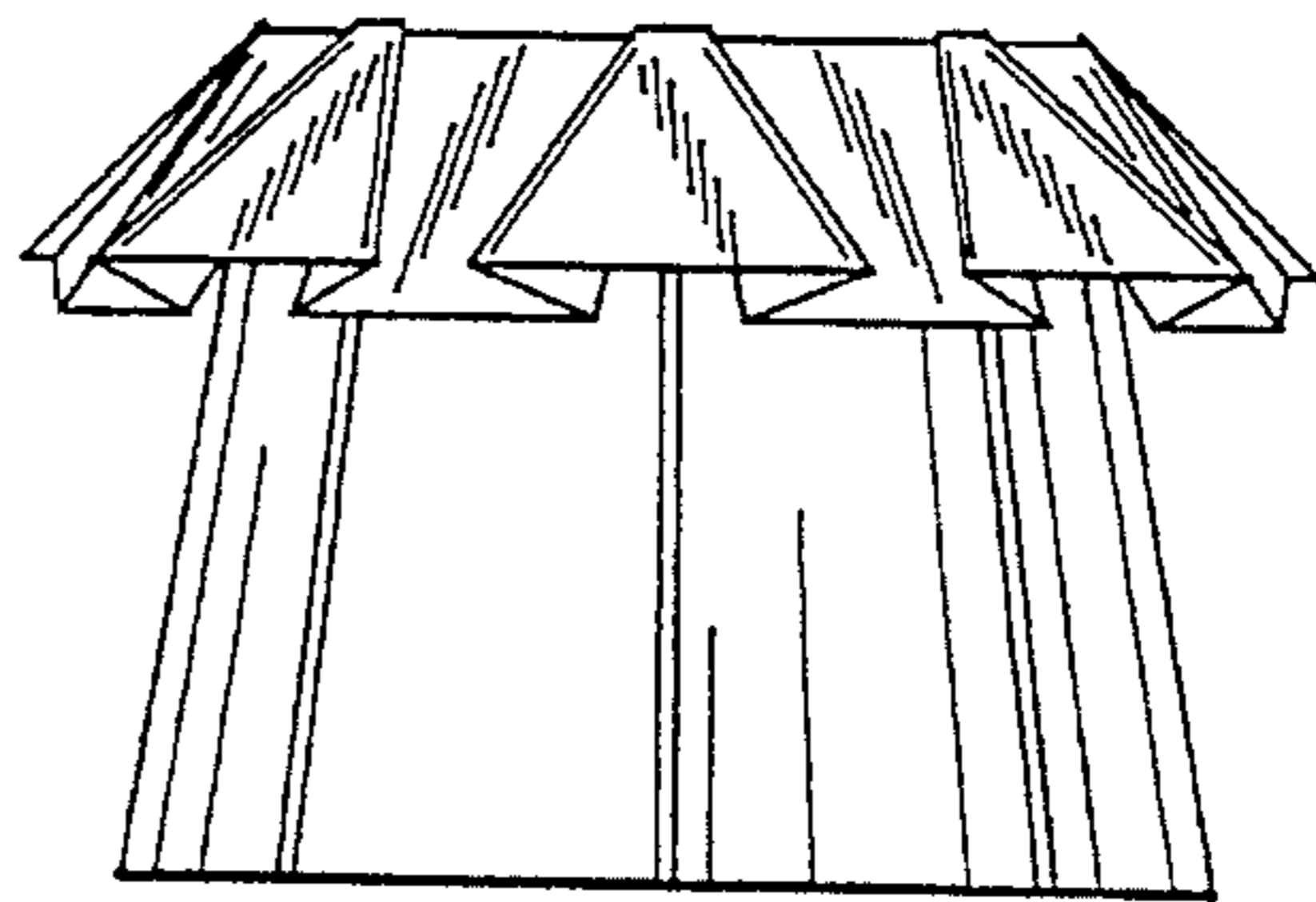

FIG. 35



UNITED STATES PATENT AND TRADEMARK OFFICE  
**CERTIFICATE OF CORRECTION**

PATENT NO. : Des. 370,644  
DATED : June 11, 1996  
INVENTOR(S) : Donald E. Weder, et. al.

It is certified that error appears in the above-identified patent and that said Letters Patent is hereby corrected as shown below:

Title page, item [73], Assignee: should read-- The Family Trust U/T/A;  
Southpac Trust International, Inc.--

Signed and Sealed this  
Twenty-third Day of September, 1997

Attest:



BRUCE LEHMAN

Attesting Officer

Commissioner of Patents and Trademarks