



US00D370552S

United States Patent [19]

Erwin et al.

[11] Patent Number: **Des. 370,552**

[45] Date of Patent: ****Jun. 11, 1996**

[54] EXERCISE PANT

[75] Inventors: **David E. Erwin**, Brooklyn, N.Y.;
Pamela E. Feltman, Arcadia, Calif.

[73] Assignee: **Alchem Capital Corporation**,
Greenville, S.C.

[**] Term: **14 Years**

[21] Appl. No.: **20,213**

[22] Filed: **Mar. 22, 1994**

[52] U.S. Cl. **D2/742**; D2/732

[58] Field of Search D2/704, 705, 712,
D2/713, 714, 731, 732, 733, 737, 738,
739, 742, 743, 749; 2/228, 401, 403

[56] **References Cited**

U.S. PATENT DOCUMENTS

D. 245,817	9/1977	Smalley	D2/732
D. 252,656	8/1979	Bergh	D2/731
D. 267,674	1/1983	Livernois	D2/742
D.343,718	2/1994	Laster	D2/738

D. 346,891	5/1994	Yee	D2/738
1,863,482	6/1932	Isaacs	D2/742
2,138,481	11/1938	Chatfield	2/403
2,462,508	2/1949	Kneibler	2/401
4,961,233	10/1990	Black	2/228
5,136,727	8/1992	Brisco	D2/738

Primary Examiner—Celia Murphy
Attorney, Agent, or Firm—Bell, Seltzer, Park & Gibson

[57] **CLAIM**

The ornamental design for an exercise pant, as shown and described.

DESCRIPTION

FIG. 1 is a rear perspective view of an exercise pant showing our new design, the broken lines shown throughout the views being understood conventional stitching;
FIG. 2 is a front plan view thereof;
FIG. 3 is a back plan view thereof;
FIG. 4 is a side view of the right side thereof; and,
FIG. 5 is a side view of the left side thereof.

1 Claim, 2 Drawing Sheets

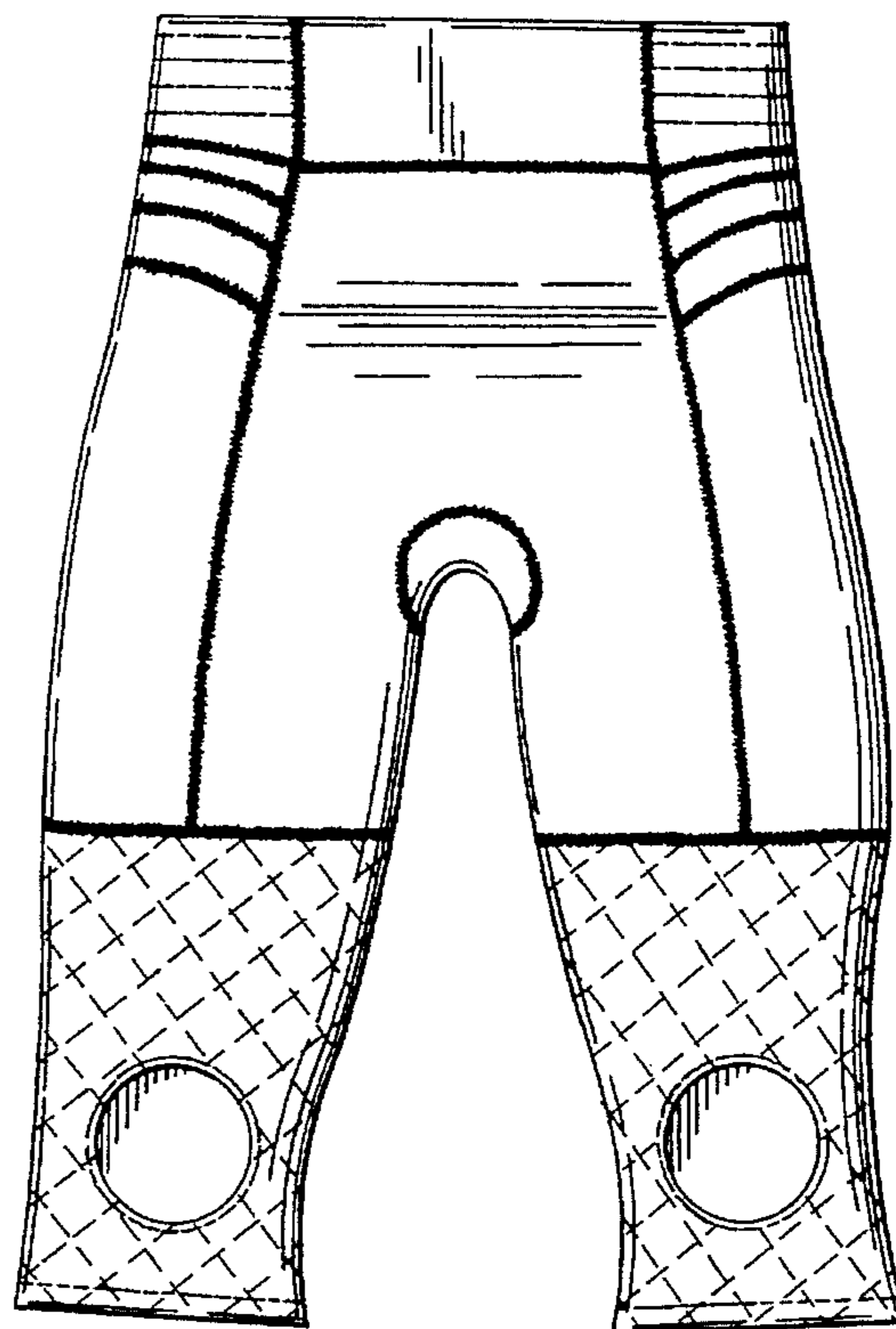
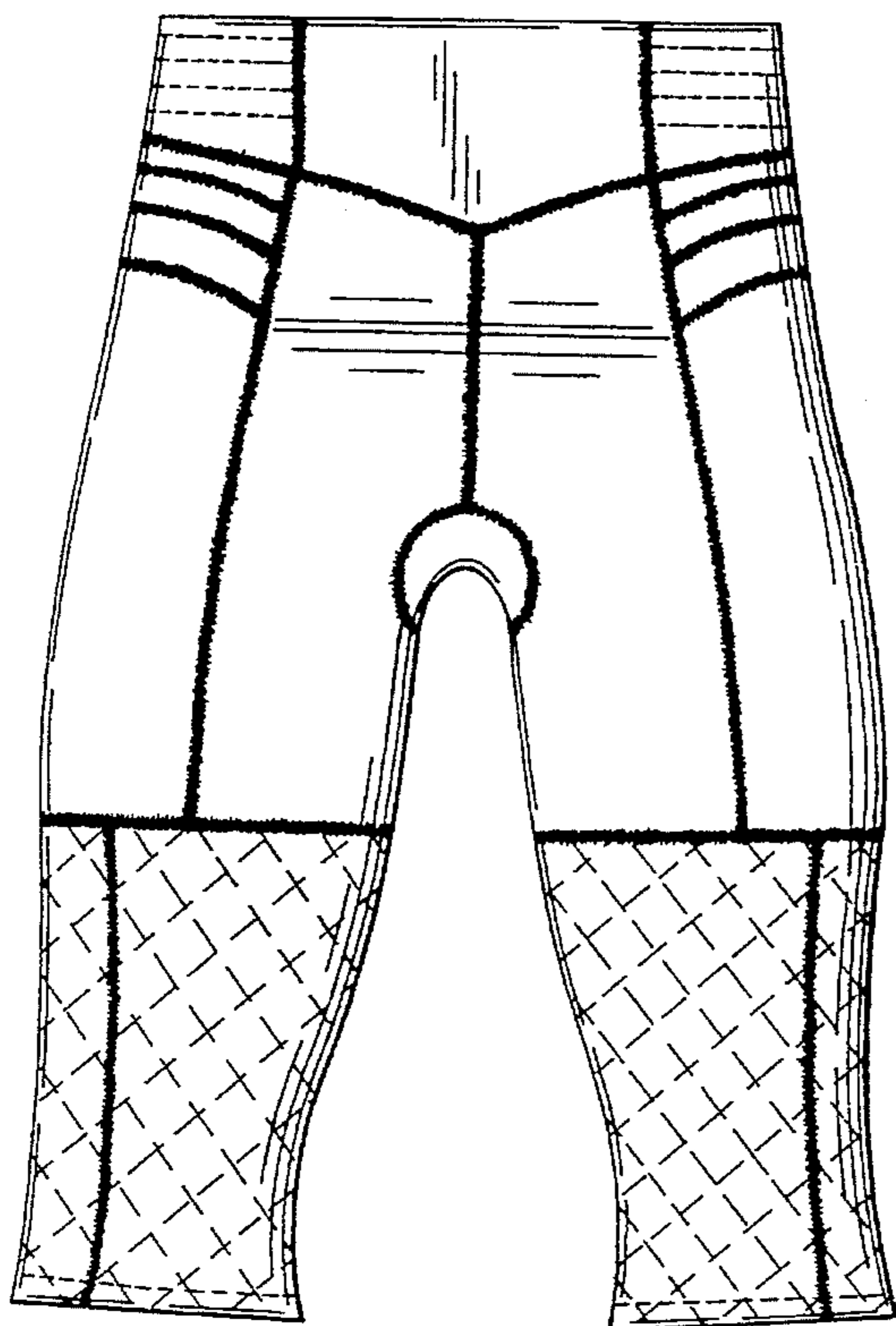

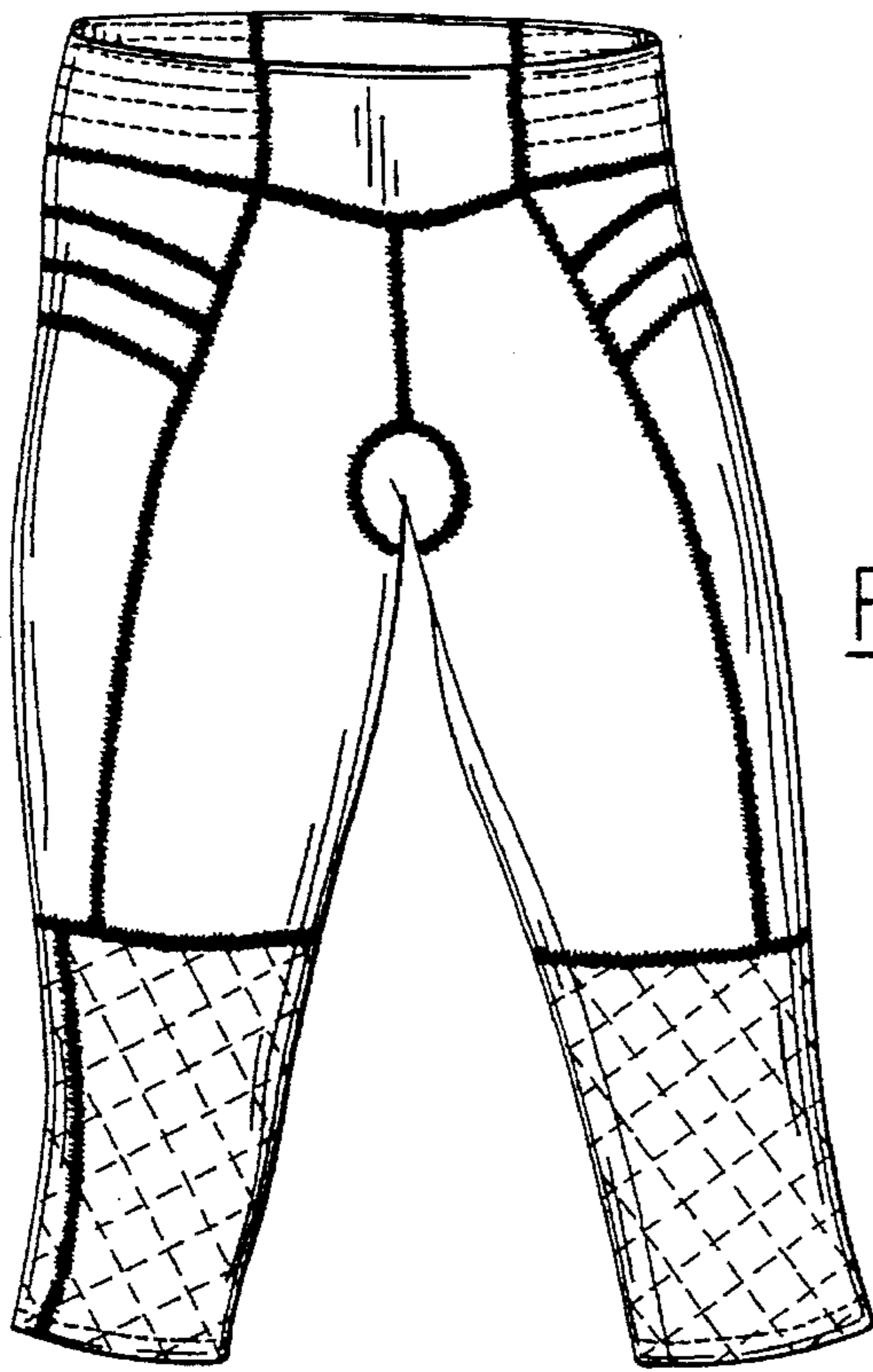

FIG. 1.

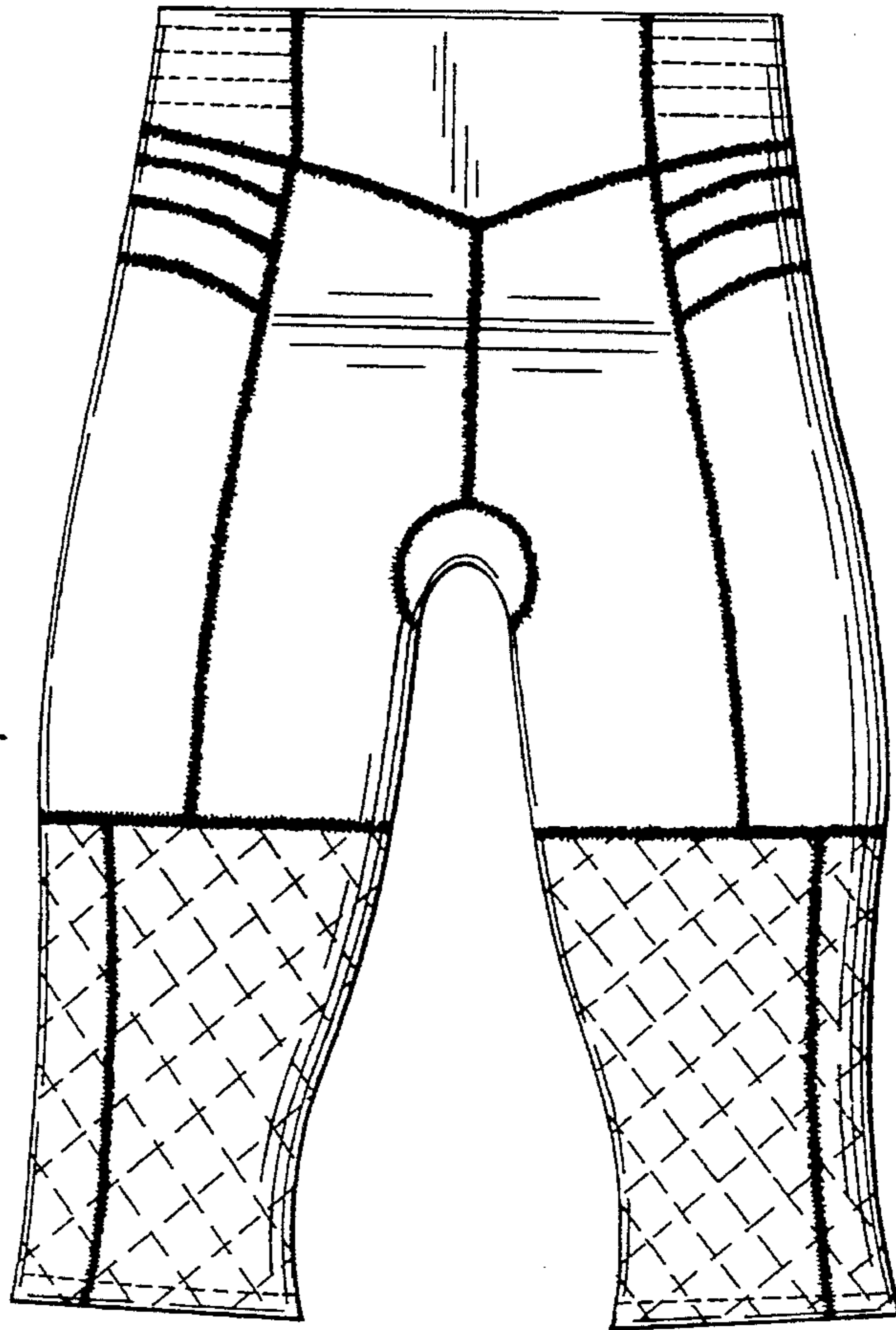

FIG. 2.

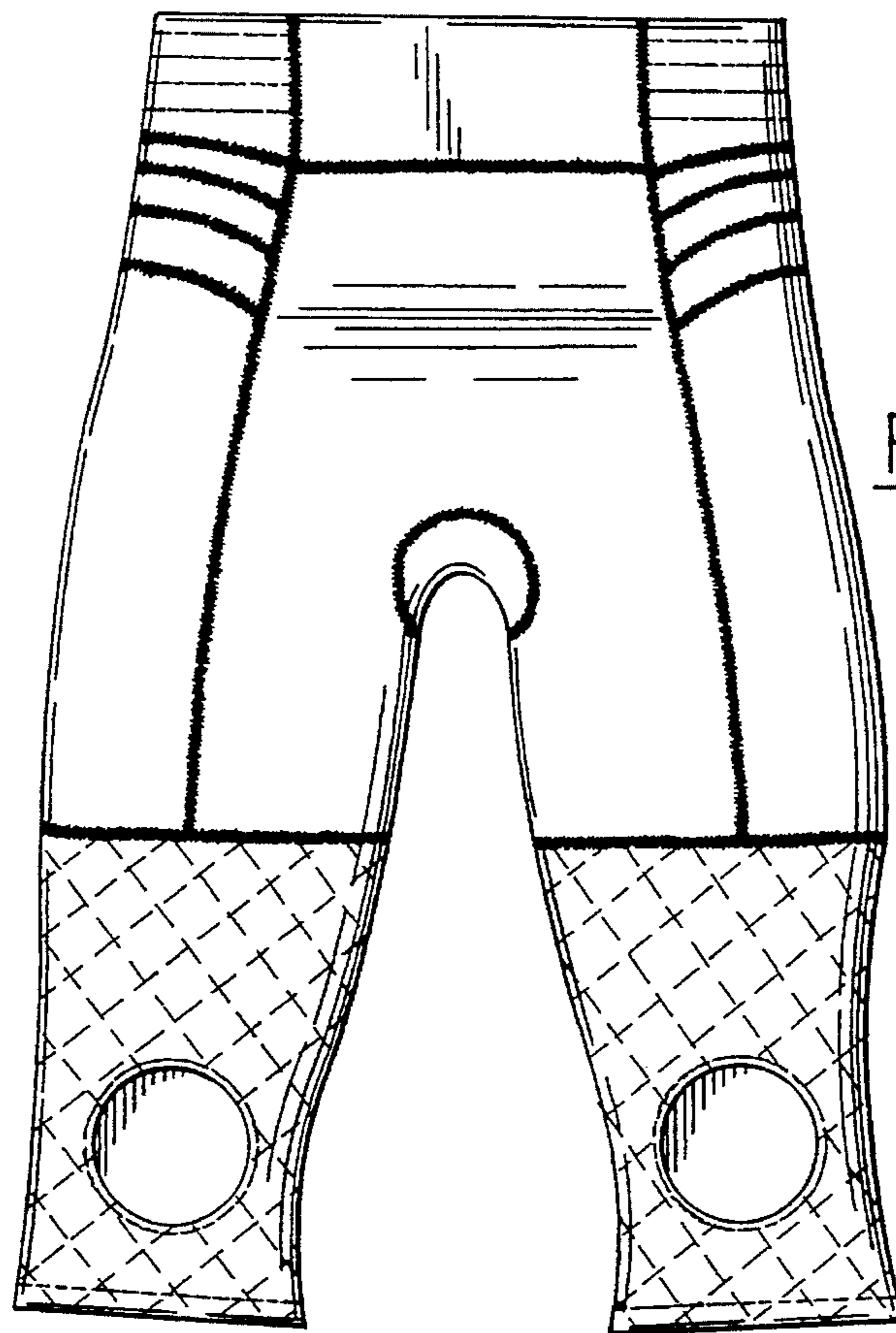

FIG. 3.

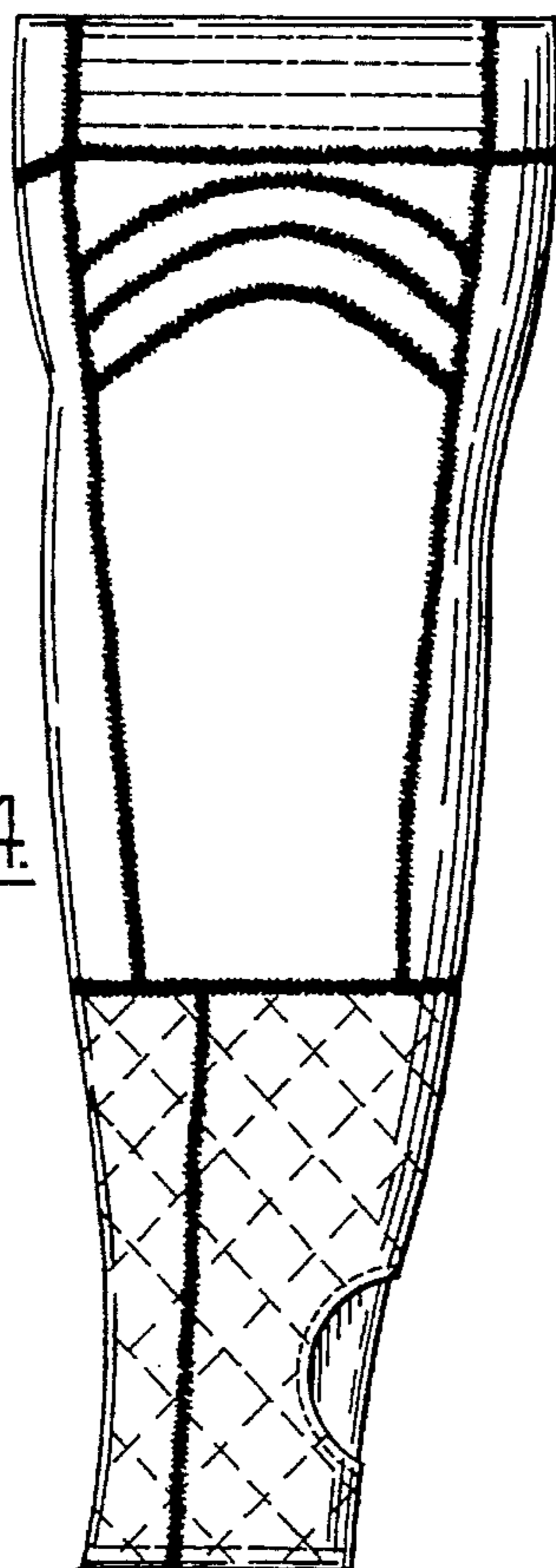

FIG. 4.

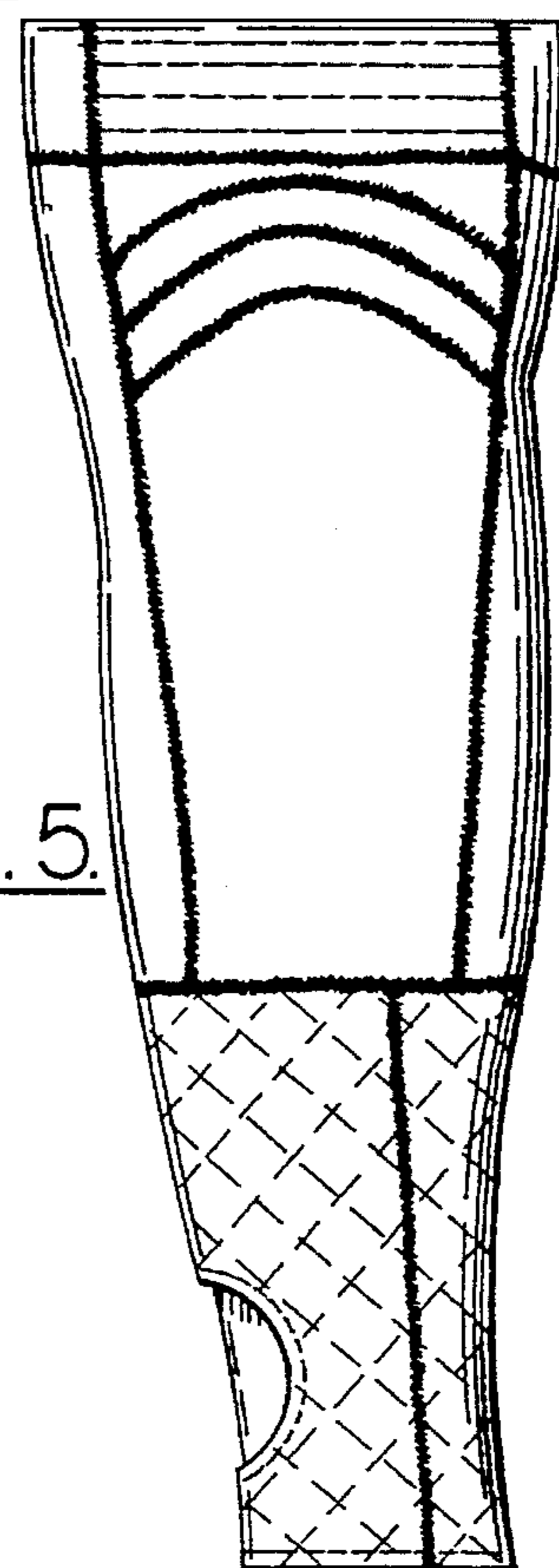

FIG. 5.