



US00D370513S

United States Patent [19]

McGraw et al.

[11] Patent Number: **Des. 370,513**

[45] Date of Patent: ***** Jun. 4, 1996**

[54] **GOLF CLUB HEAD**

[75] Inventors: **Ronnie F. McGraw**, Glen Allen;
Donald S. Rahrig, Richmond, both of Va.

[73] Assignee: **Ben Hogan Company**, Richmond, Va.

[*] Notice: The portion of the term of this patent subsequent to Nov. 21, 2009, has been disclaimed.

[**] Term: **14 Years**

[21] Appl. No.: **28,665**

[22] Filed: **Sep. 20, 1994**

[52] U.S. Cl. **D21/220**

[58] Field of Search D21/220; 273/167-175

[56] **References Cited**

U.S. PATENT DOCUMENTS

D. 304,485	11/1989	Long	D21/220
D. 306,195	2/1990	MacNally et al.	D21/220
D. 329,266	9/1992	Antonious	D21/220
D. 353,644	12/1994	Hirsch et al.	D21/220
D. 355,234	2/1995	MacNally et al.	D21/220
3,059,926	10/1962	Johnstone .	

3,655,188	4/1972	Solheim .
4,848,747	7/1989	Fujimura .
5,011,151	4/1991	Antonious .
5,026,056	6/1991	McNally .
5,160,136	11/1992	Eger .
5,160,137	11/1992	Katayama .
5,209,473	5/1993	Fisher .

Primary Examiner—Terry A. Wallace
Assistant Examiner—Mitchell I. Siegel
Attorney, Agent, or Firm—Martin Smolowitz

[57] **CLAIM**

The ornamental design for a golf club head, as shown and described.

DESCRIPTION

FIG. 1 is a front elevational view of the golf club head showing our new design;
FIG. 2 is a top plan view thereof;
FIG. 3 is a right side view thereof;
FIG. 4 is a left side view thereof;
FIG. 5 is a bottom plan view thereof;
FIG. 6 is a rear elevational view thereof; and,
FIG. 7 is a cross-sectional view taken along lines 7/7 of FIG. 1.

1 Claim, 3 Drawing Sheets

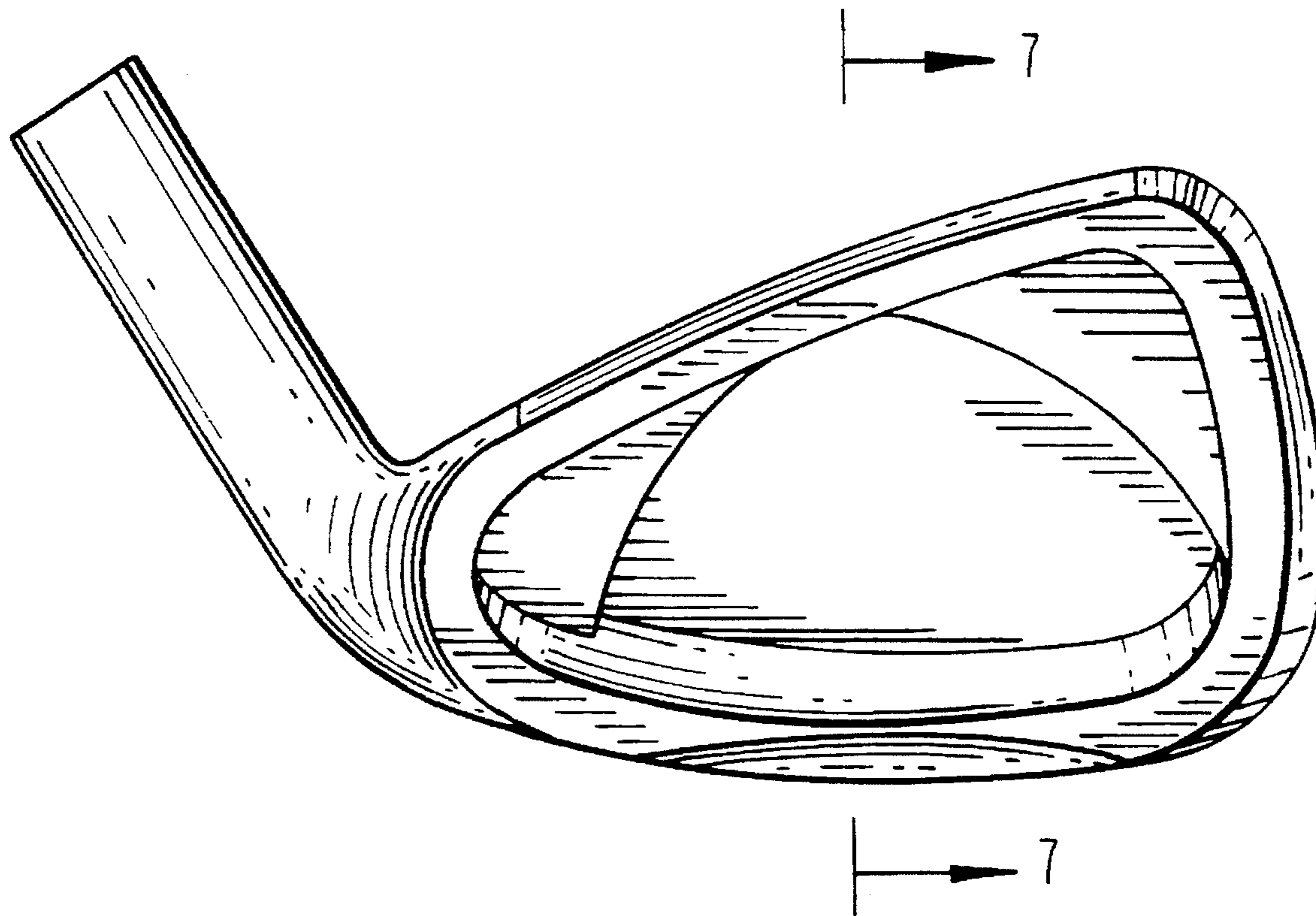

FIG. 1

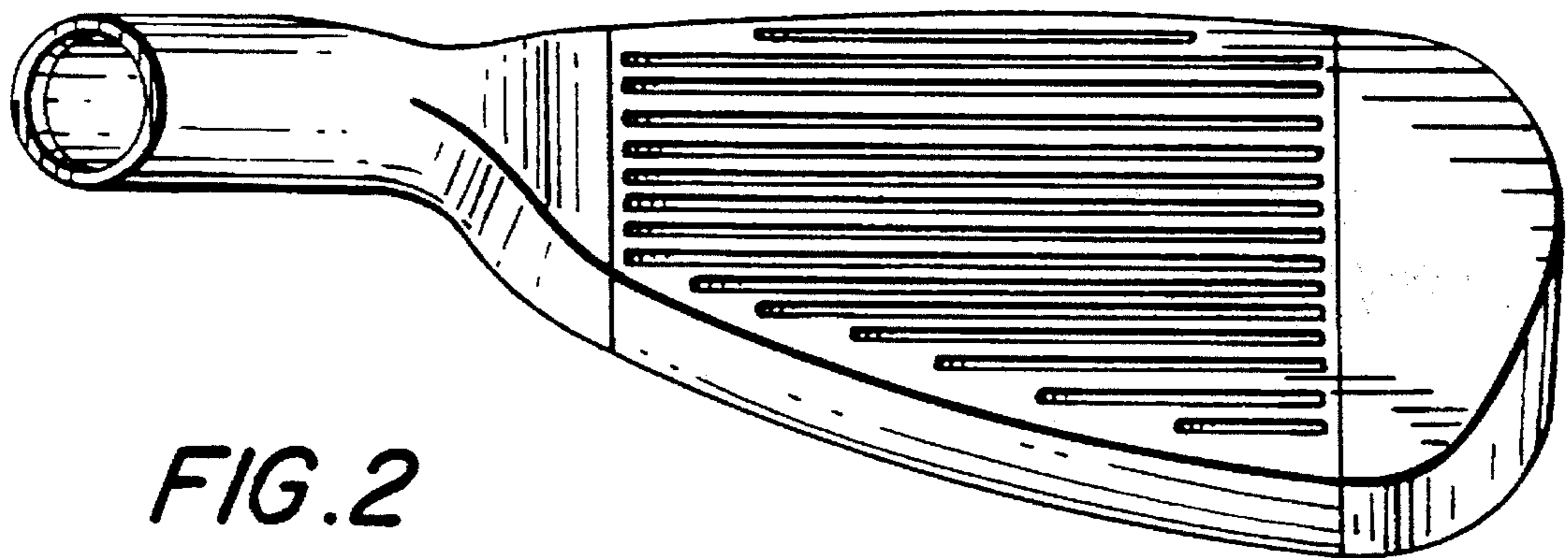
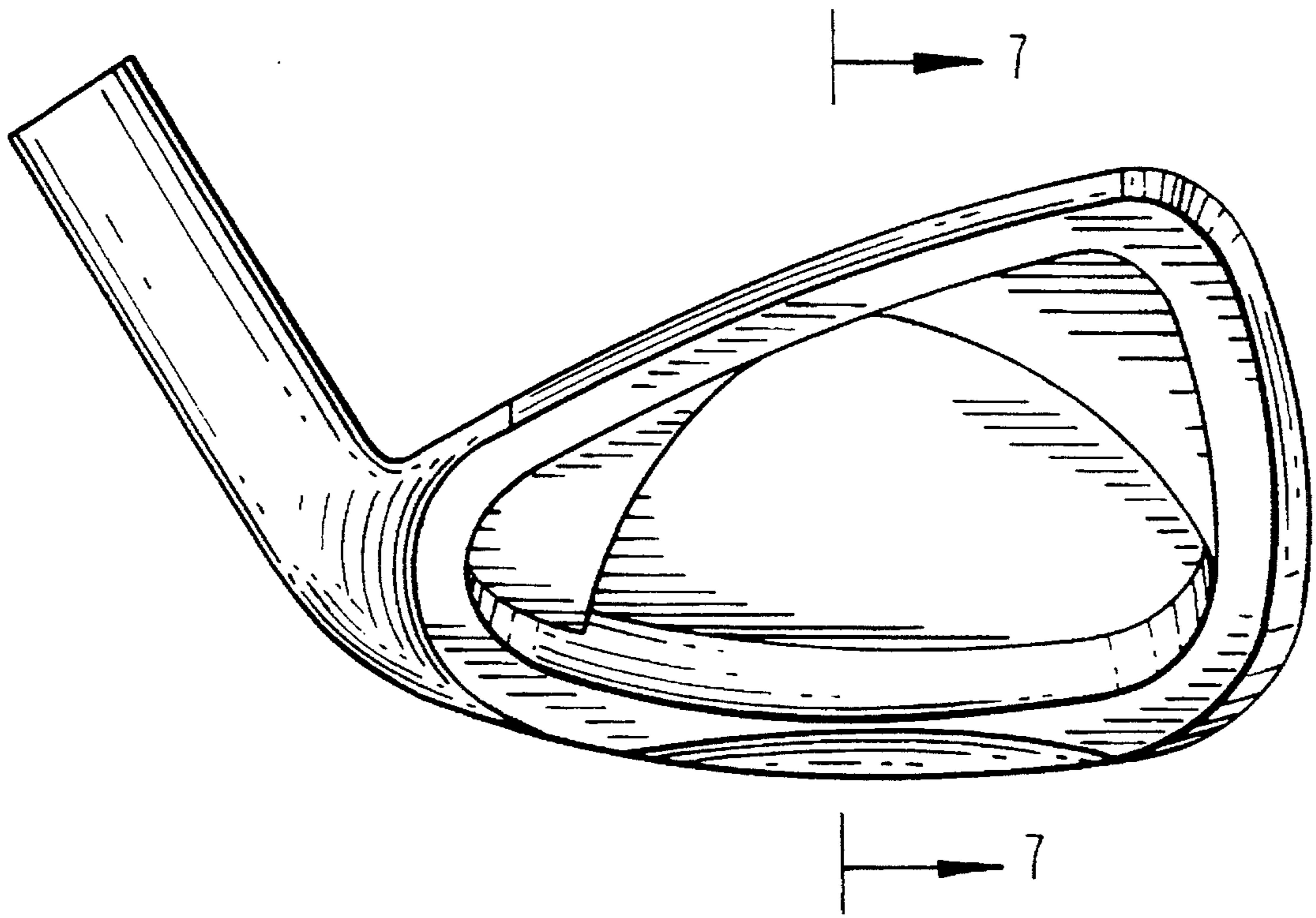

FIG. 2

FIG. 3

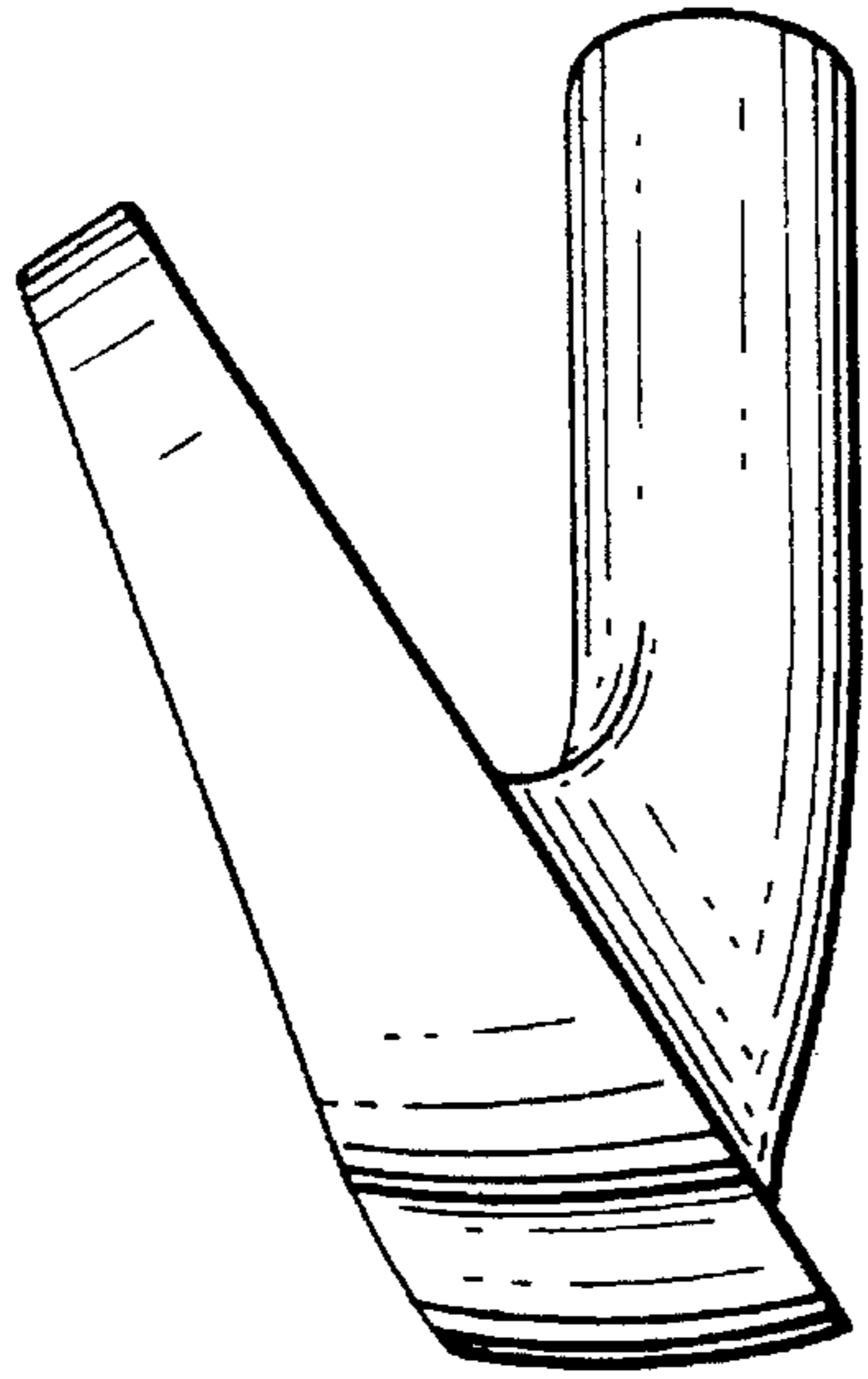

FIG. 4

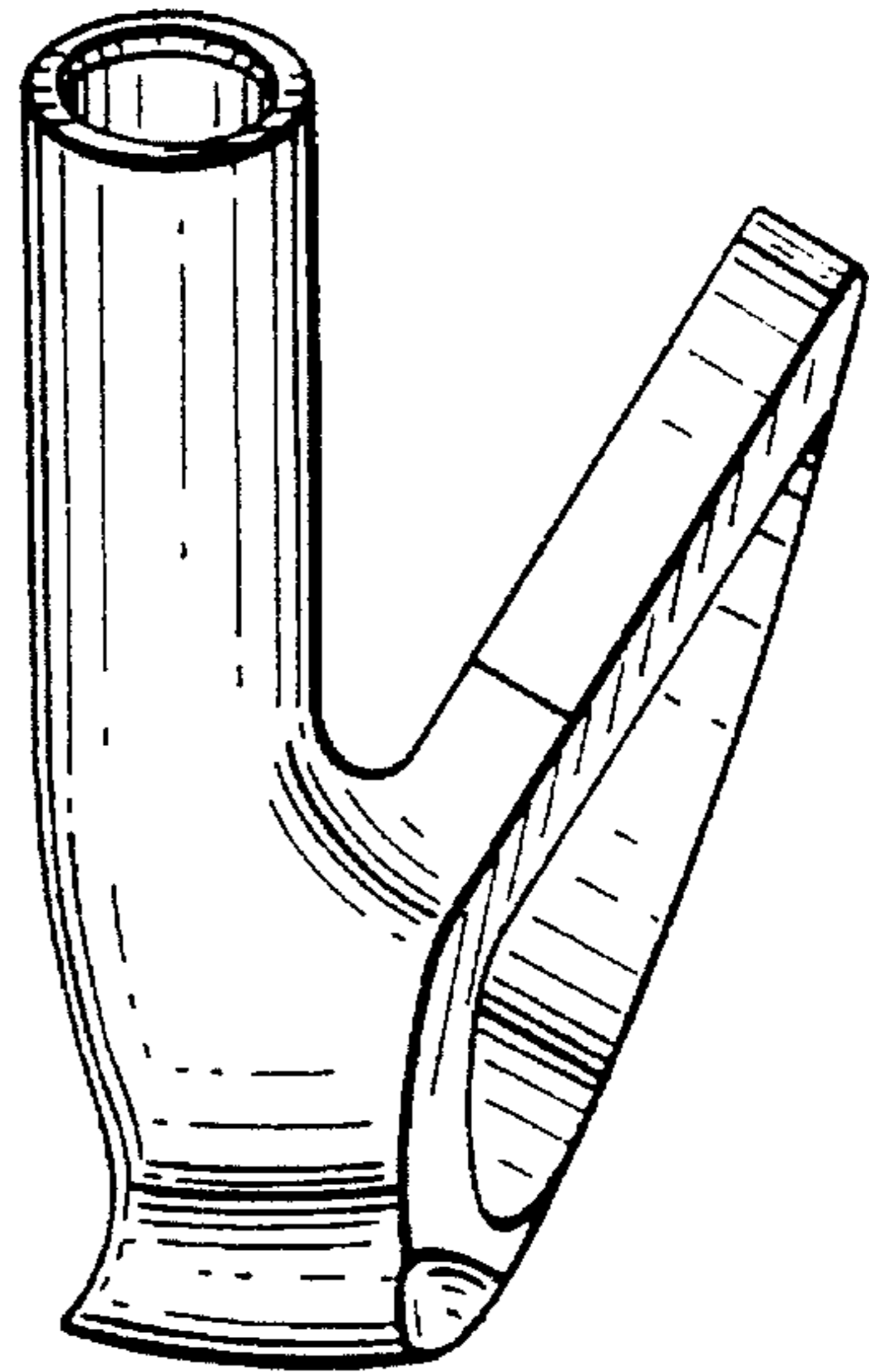

FIG. 5

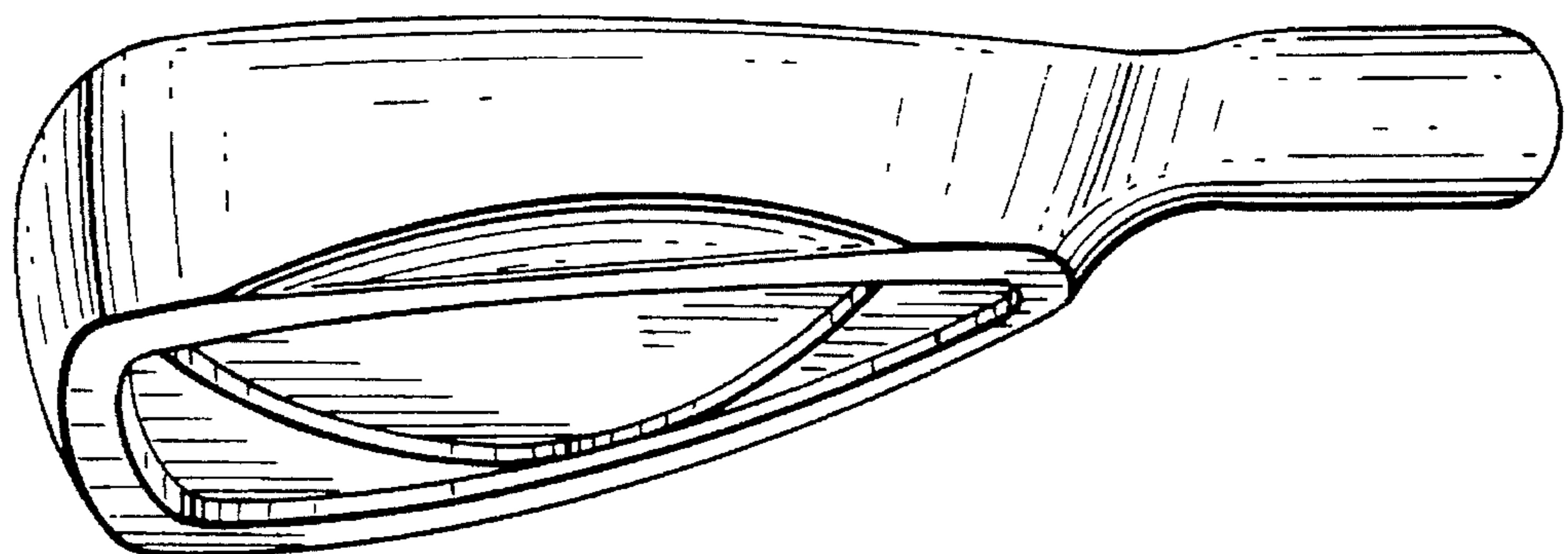

FIG. 6

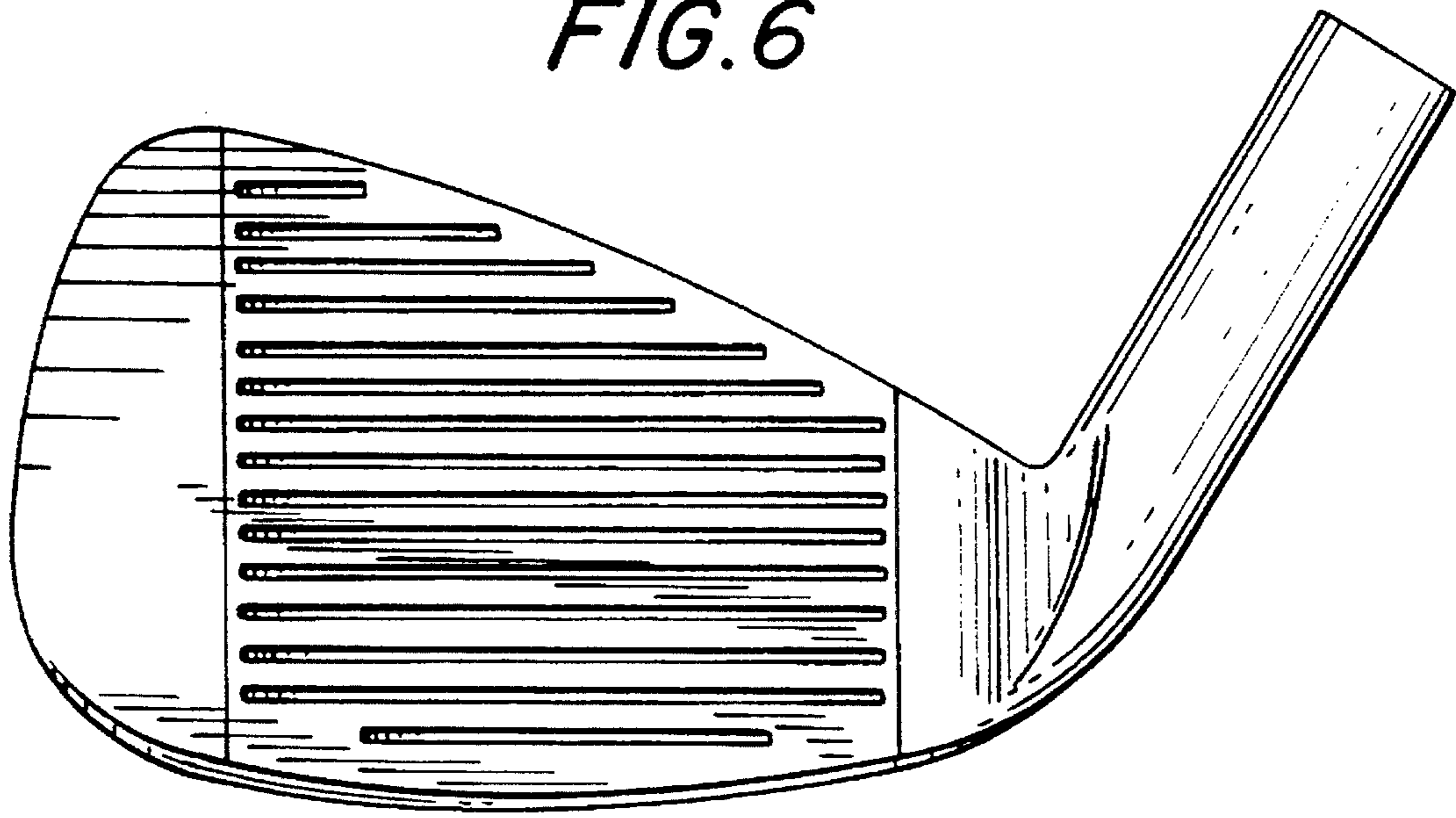

FIG. 7

