



US00D370487S

United States Patent [19] Burtell, Sr.

[11] Patent Number: **Des. 370,487**
[45] Date of Patent: ****Jun. 4, 1996**

[54] **TELEPHONE ENCLOSURE**

[75] Inventor: **Charles Burtell, Sr.**, S. Barrington, Ill.

[73] Assignee: **Enclosures, Inc.**, Franklin Park, Ill.

[**] Term: **14 Years**

[21] Appl. No.: **37,059**

[22] Filed: **Apr. 3, 1995**

[52] U.S. Cl. **D14/250; D14/146**

[58] Field of Search 379/143, 145,
379/437, 440, 451, 428; 52/27.5; D14/142,
146, 140, 240, 250, 150; D6/421

[56] **References Cited**

U.S. PATENT DOCUMENTS

D. 236,991	9/1975	Batke et al.	D14/142
D. 315,908	4/1991	Ward	D14/250
3,511,941	5/1970	Quigley	52/27.5
5,131,035	7/1992	Ohayon	379/437
5,134,654	7/1992	McGough	379/428
5,148,476	9/1992	Zausner	379/440 X
5,381,469	1/1995	Zausner	379/440 X
5,402,476	3/1995	Ohayon	379/440 X

OTHER PUBLICATIONS

Advertisement for Sentinel 911 BL, *Phone Plus Trade Journal*, Jan. 1995.

Primary Examiner—Jeffrey Asch
Attorney, Agent, or Firm—Trexler, Bushnell, Giangiorgi & Blackstone, Ltd.

[57] **CLAIM**

The ornamental design for a telephone enclosure, as shown and described.

DESCRIPTION

FIG. 1 is a perspective view of the telephone enclosure design shown in full lines, with the broken lines illustrating a pedestal mounted telephone on which the design may be used, but which forms no part of the claimed design;

FIG. 2 is another perspective view of the telephone enclosure of the present invention isolated from its environmental association with a pedestal mounted telephone;

FIG. 3 is a top plan view of the telephone enclosure of the present invention;

FIG. 4 is a front elevational view of the telephone enclosure of the present invention;

FIG. 5 is a rear elevational view of the telephone enclosure of the present invention;

FIG. 6 is a right side elevational view of the telephone enclosure of the present invention;

FIG. 7 is a left side elevational view of the telephone enclosure of the present invention; and,

FIG. 8 is a bottom plan view of the telephone enclosure of the present invention.

1 Claim, 2 Drawing Sheets

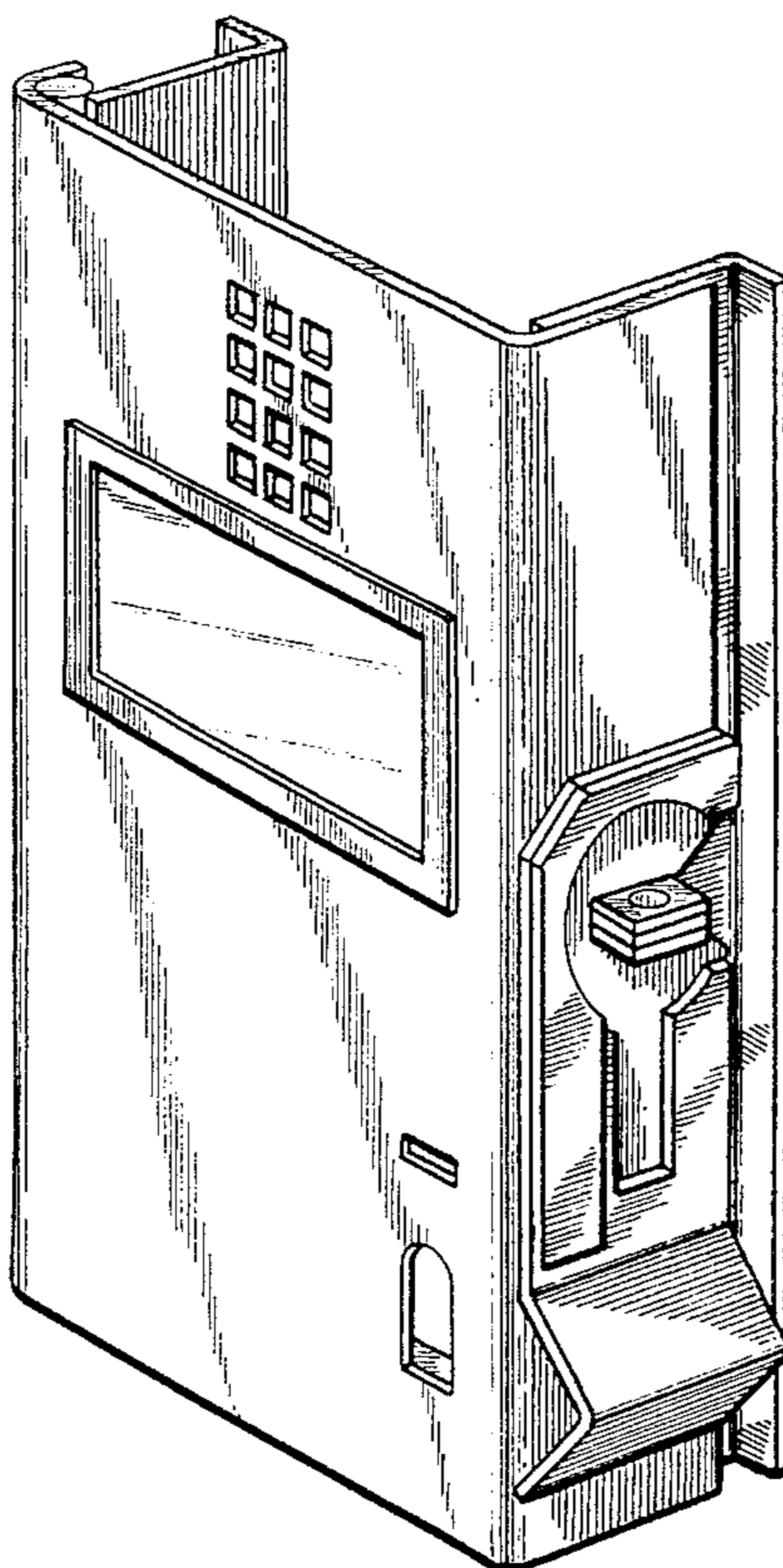

FIG. 1

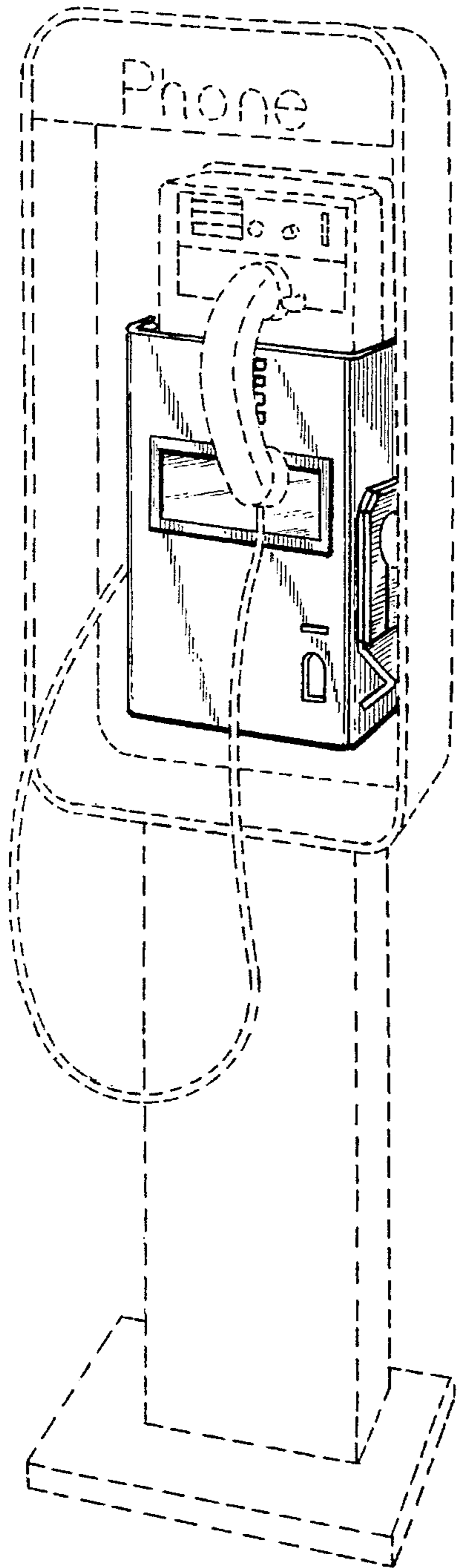

FIG. 2

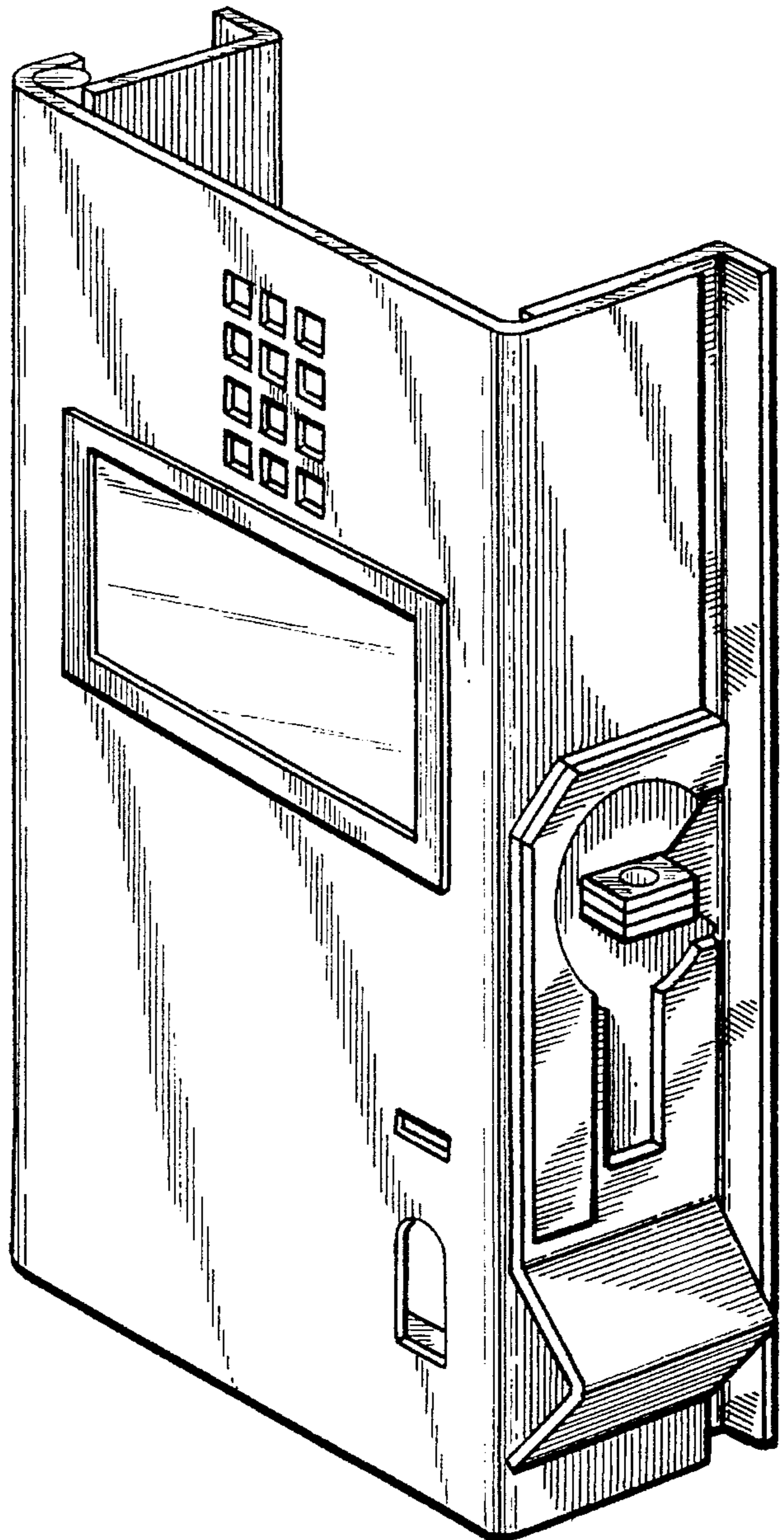

FIG. 3

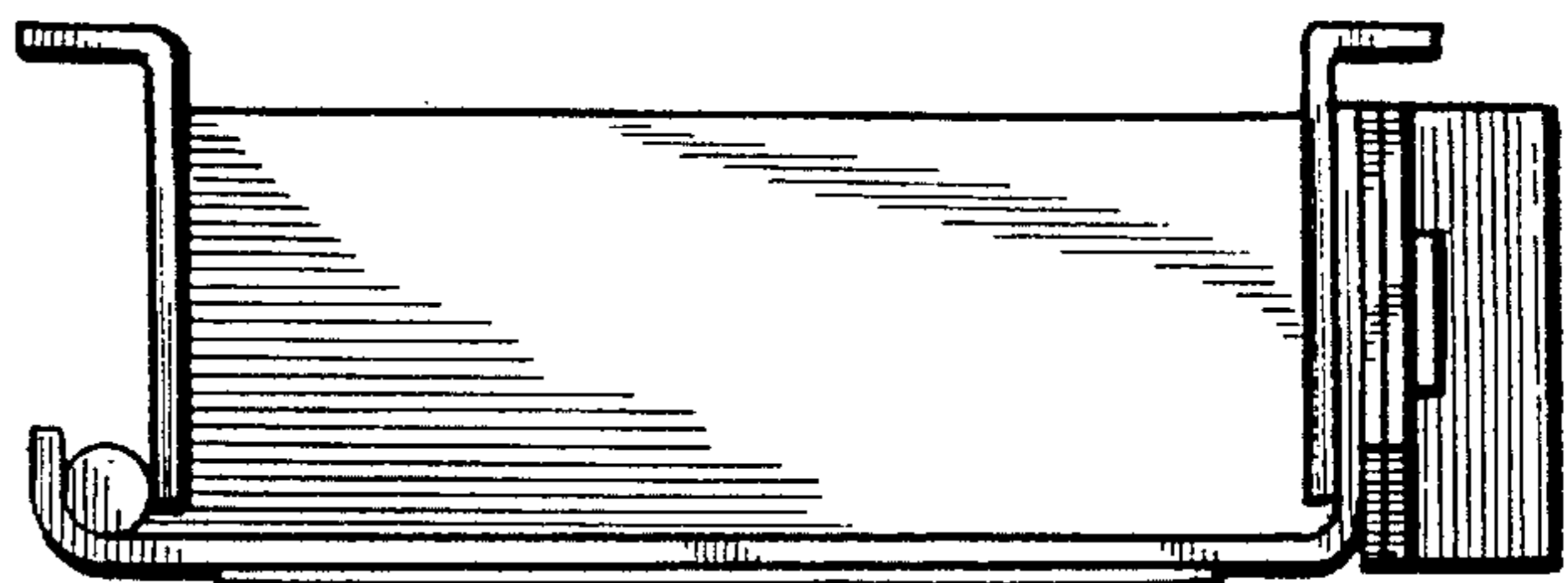

FIG 4

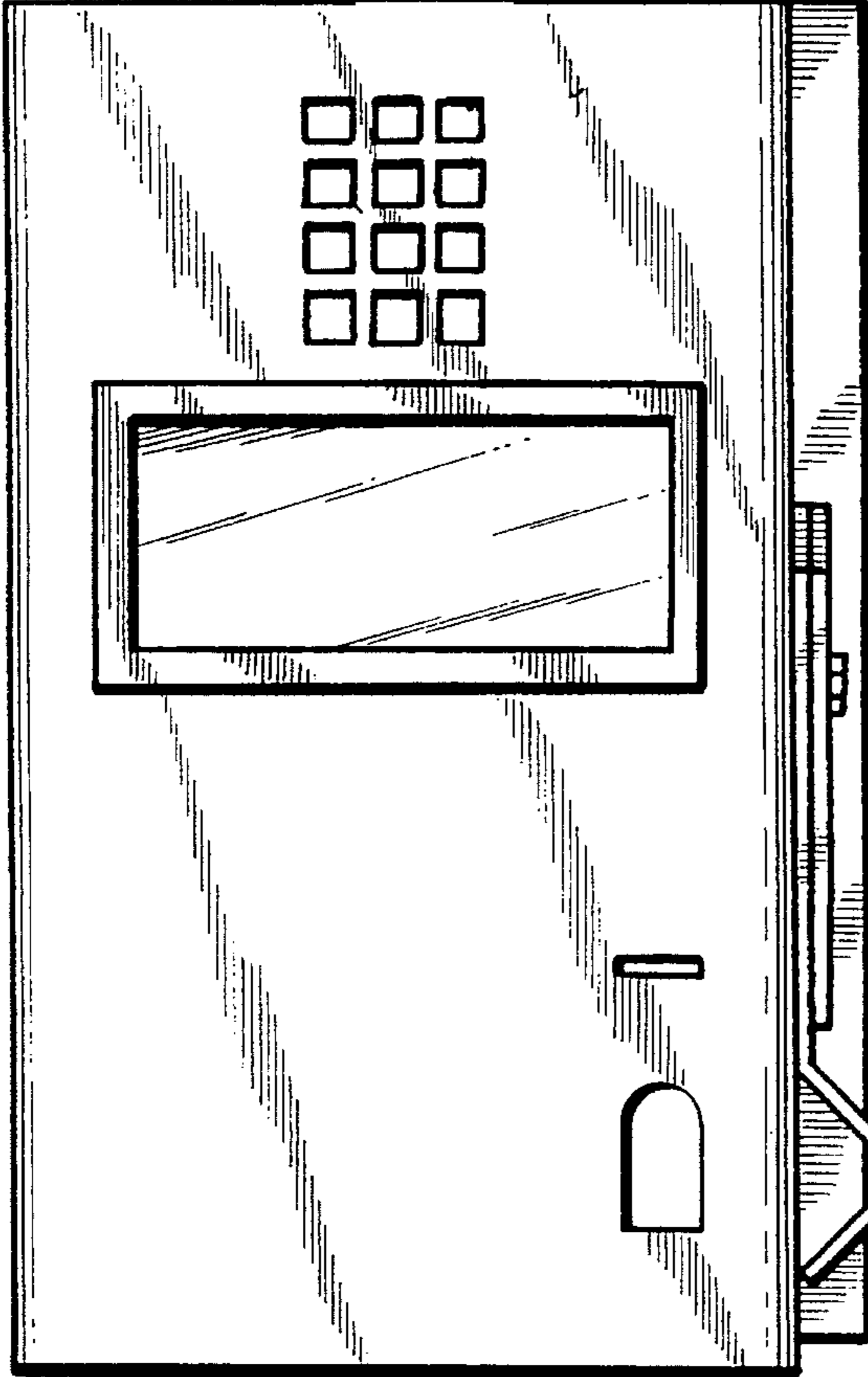

FIG.5

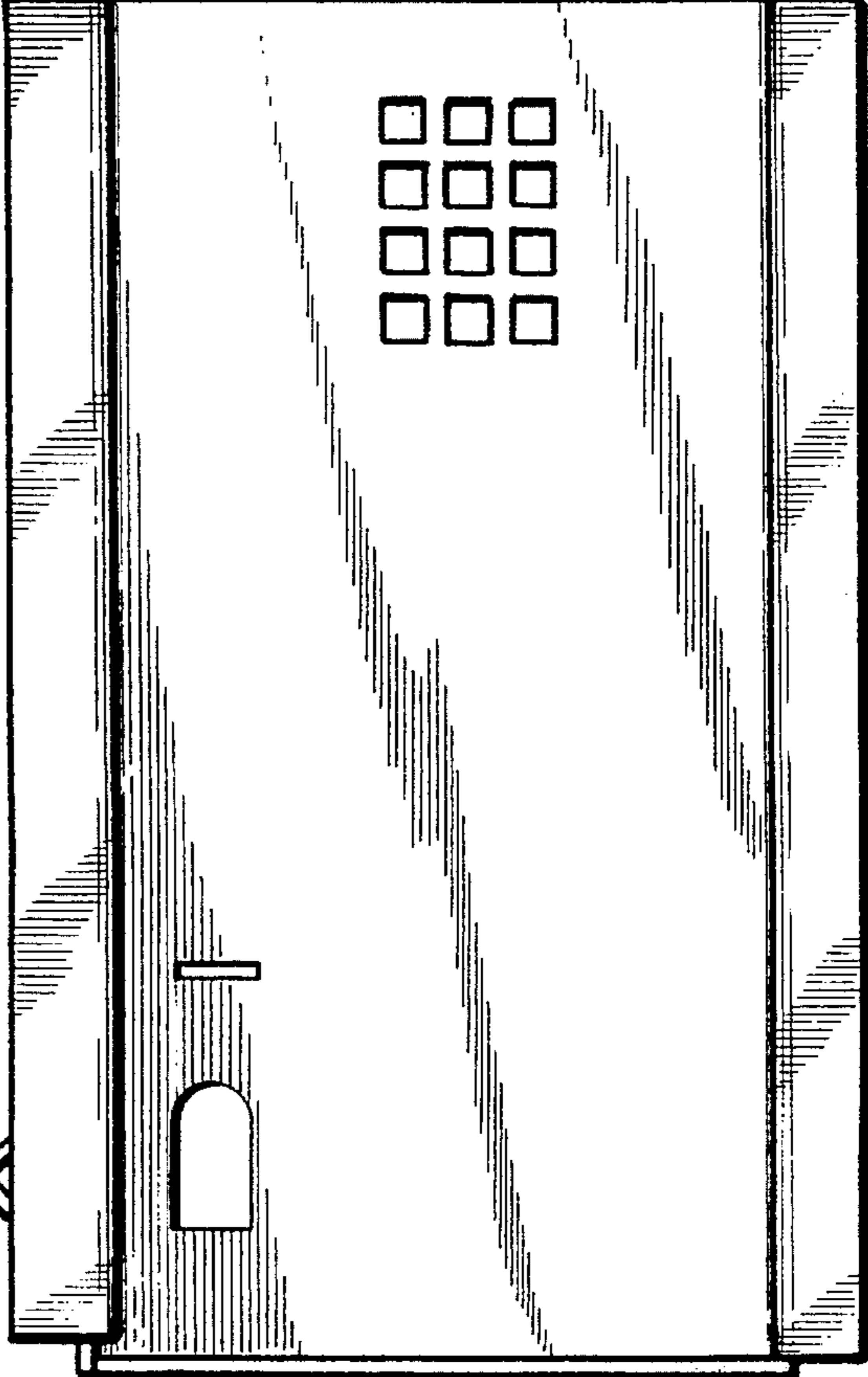

FIG.6

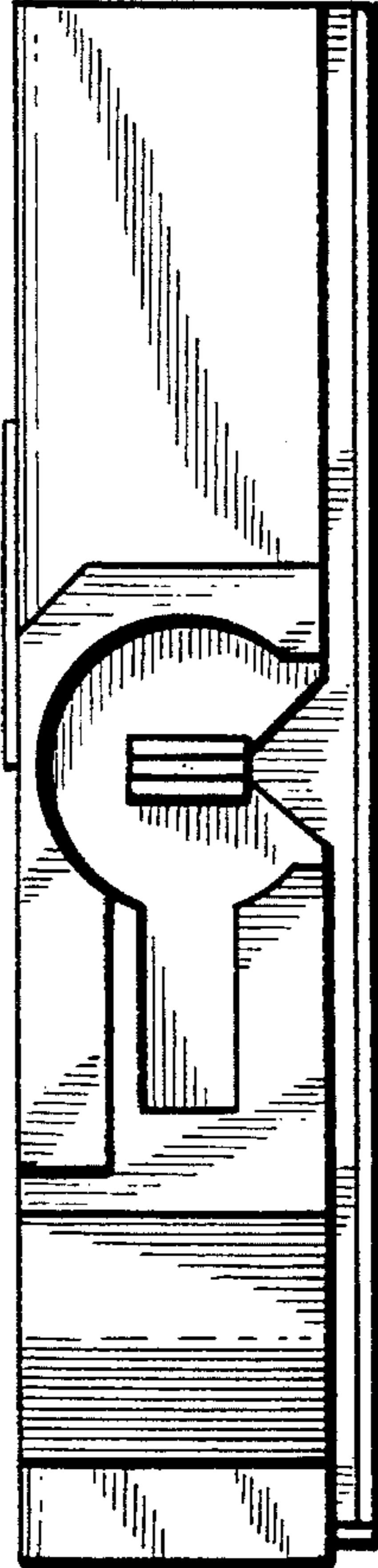

FIG.7

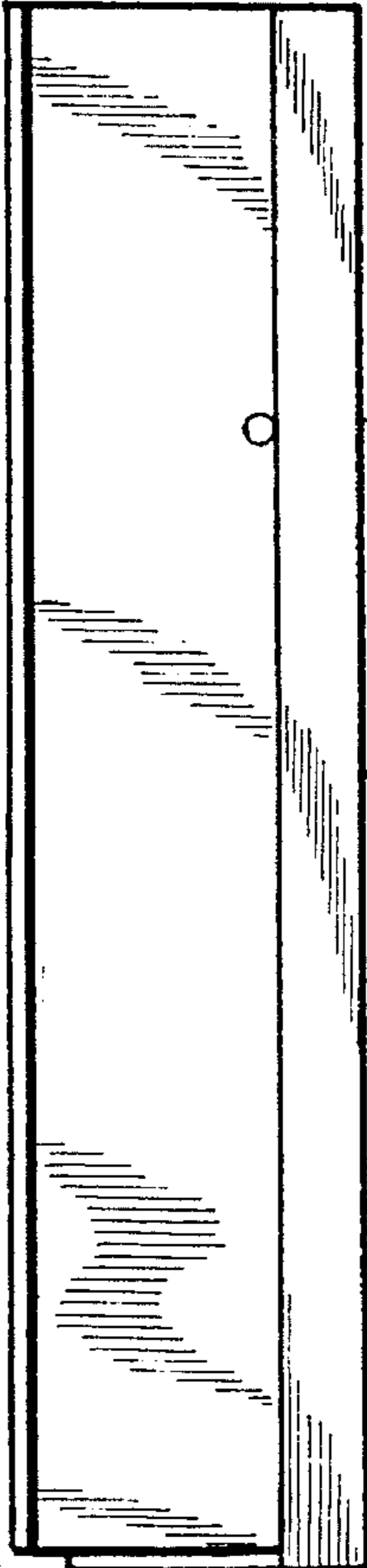

FIG.8

