



US00D370433S

United States Patent [19]

[11] Patent Number: **Des. 370,433**

Weder et al.

[45] Date of Patent: ***** Jun. 4, 1996**

- [54] **FLOWER POT COVER**
- [75] Inventors: **Donald E. Weder; Joseph G. Straeter**, both of Highland, Ill.
- [73] Assignee: **Highland Supply Corporation**, Highland, Ill.
- [*] Notice: The portion of the term of this patent subsequent to Oct. 3, 2009, has been disclaimed.
- [**] Term: **14 Years**

D. 327,234	6/1992	Vaughn	D11/143
D. 329,407	9/1992	Weder et al.	D11/164
1,065,486	6/1913	Washburn	229/400
2,054,934	9/1936	Graffenberger	229/1.5 B
2,102,510	12/1937	Cecil, 2d	229/1.5 B
2,355,559	8/1944	Renner	229/8
2,459,073	1/1949	Hamilton	229/1.5 B
5,127,817	7/1992	Weder et al.	425/383
5,152,101	10/1992	Weder et al.	47/72

FOREIGN PATENT DOCUMENTS

103316	3/1938	Australia	229/922
--------	--------	-----------	-------	---------

OTHER PUBLICATIONS

Exhibit A—Speed Cover ® Brochure—The Simple Solution . . . , ©1989.

Primary Examiner—Jeffrey Asch
Attorney, Agent, or Firm—Dunlap & Codding

- [21] Appl. No.: **7,353**
- [22] Filed: **Jan. 5, 1993**

Related U.S. Application Data

- [63] Continuation-in-part of Ser. No. 808,561, Dec. 16, 1991, which is a continuation-in-part of Ser. No. 710,272, Jun. 4, 1991, which is a continuation-in-part of Ser. No. 617,454, Nov. 21, 1990, abandoned, said Ser. No. 710,272, is a continuation-in-part of Ser. No. 411,249, Sep. 22, 1989, Pat. No. Des. 358,113, and Ser. No. 411,247, Sep. 22, 1989, and Ser. No. 411,245, Sep. 22, 1989.
- [52] **U.S. Cl.** **D11/164**
- [58] **Field of Search** D11/143, 149, D11/152–156, 164, 89, 90; 47/66, 72; 206/423; 215/100.5; 229/1.5 R, 1.5 B, 4.5, 87.01, 922, 930, 108, 108.1, 109, 110, 400; 428/27, 35.1, 24, 542.6; D9/346, 428–431; D27/102, 133; D26/128–136; D19/96; D7/540, 584, 586, 587, 354

[57] CLAIM

The ornamental design for a flower pot cover, as shown and described.

DESCRIPTION

FIG. 1 is a perspective view of our new flower pot cover design;
 FIG. 2 is a side elevational view thereof;
 FIG. 3 is a top plan view thereof;
 FIG. 4 is a bottom plan view thereof;
 FIG. 5 is a side elevational view of the design of FIG. 1, the only difference being in the horizontal angle of the skirt;
 FIG. 6 is a side elevational view of the design of FIG. 1, the only difference being in the near vertical angle of the skirt;
 FIG. 7 is a side elevational view of the design of FIG. 1, the only difference being in the downward angle of the skirt;
 FIG. 8 is a side elevational view of a second embodiment of the design of FIG. 1, the only difference being in the placement of the cutouts in the base;
 FIG. 9 is a side elevational view of a third embodiment of the design of FIG. 1, the only difference being in the placement of the cutouts in the base;
 FIG. 10 is a side elevational view of a fourth embodiment of the design of FIG. 1, the only difference being in the placement of the cutouts in the base;

[56] References Cited

U.S. PATENT DOCUMENTS

D. 292,182	10/1987	Weder et al.	D11/164
D. 292,562	11/1987	Weder et al.	D11/164
D. 293,224	12/1987	Weder et al.	D11/164
D. 293,775	1/1988	Weder et al.	D11/164
D. 313,376	1/1991	Weder	D11/152
D. 314,732	2/1991	Weder	D11/143 X
D. 317,583	6/1991	Weder et al.	D11/164
D. 318,030	7/1991	Weder et al.	D11/164
D. 319,034	8/1991	Weder et al.	D11/164
D. 326,244	5/1992	Weder	D11/164

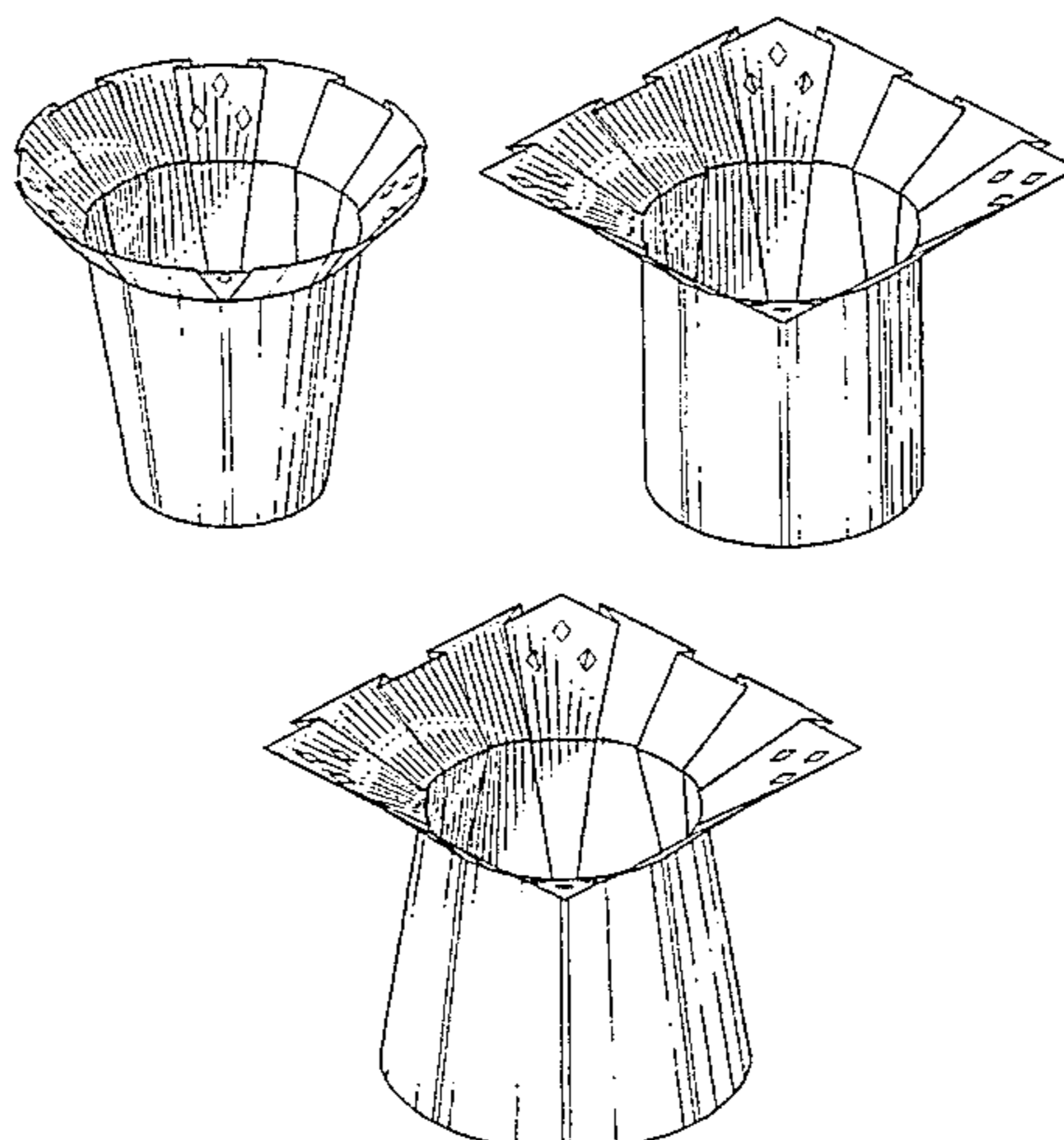

FIG. 11 is a perspective view of a fifth embodiment of our new flower pot cover design;

FIG. 12 is a side elevational view thereof;

FIG. 13 is a top plan view thereof;

FIG. 14 is a bottom plan view thereof;

FIG. 15 is a side elevational view of the design of FIG. 11, the only difference being in the horizontal angle of the skirt;

FIG. 16 is a side elevational view of the design of FIG. 11, the only difference being in the near vertical angle of the skirt;

FIG. 17 is a side elevational view of the design of FIG. 11, the only difference being in the downward angle of the skirt;

FIG. 18 is a side elevational view of a sixth embodiment of the design of FIG. 11, the only difference being in the placement of the cutouts in the base;

FIG. 19 is a side elevational view of a seventh embodiment of the design of FIG. 11, the only difference being in the placement of the cutouts in the base;

FIG. 20 is a side elevational view of an eighth embodiment of the design of FIG. 11, the only difference being in the placement of the cutouts in the base;

FIG. 21 is a perspective view of a ninth embodiment of our new flower pot cover design;

FIG. 22 is a side elevational view thereof;

FIG. 23 is a top plan view thereof;

FIG. 24 is a bottom plan view thereof;

FIG. 25 is a side elevational view of the design of FIG. 21, the only difference being in the horizontal angle of the skirt;

FIG. 26 is a side elevational view of the design of FIG. 21, the only difference being in the near vertical angle of the skirt;

FIG. 27 is a side elevational view of the design of FIG. 21, the only difference being in the downward angle of the skirt;

FIG. 28 is a side elevational view of a tenth embodiment of the design of FIG. 21, the only difference being in the placement of the cutouts in the base;

FIG. 29 is a side elevational view of an eleventh embodiment of the design of FIG. 21, the only difference being in the placement of the cutouts in the base;

FIG. 30 is a side elevational view of a twelfth embodiment of the design of FIG. 21, the only difference being in the placement of the cutouts in the base;

FIG. 31 is a perspective view of a thirteenth embodiment of our new flower pot cover design;

FIG. 32 is a side elevational view thereof;

FIG. 33 is a top plan view thereof;

FIG. 34 is a bottom plan view thereof;

FIG. 35 is a side elevational view of the design of FIG. 31, the only difference being in the horizontal angle of the skirt;

FIG. 36 is a side elevational view of the design of FIG. 31, the only difference being in the near vertical angle of the skirt;

FIG. 37 is a side elevational view of the design of FIG. 31, the only difference being in the downward angle of the skirt;

FIG. 38 is a side elevational view of a fourteenth embodiment of the design of FIG. 31, the only difference being in the placement of the cutouts in the base;

FIG. 39 is a side elevational view of a fifteenth embodiment of the design of FIG. 31, the only difference being in the placement of the cutouts in the base;

FIG. 40 is a side elevational view of a sixteenth embodiment of the design of FIG. 31, the only difference being in the placement of the cutouts in the base;

FIG. 41 is a perspective view of a seventeenth embodiment of our new flower pot cover design;

FIG. 42 is a side elevational view thereof;

FIG. 43 is a top plan view thereof;

FIG. 44 is a bottom plan view thereof;

FIG. 45 is a side elevational view of the design of FIG. 41, the only difference being in the horizontal angle of the skirt;

FIG. 46 is a side elevational view of the design of FIG. 41, the only difference being in the near vertical angle of the skirt;

FIG. 47 is a side elevational view of the design of FIG. 41, the only difference being in the downward angle of the skirt;

FIG. 48 is a side elevational view of an eighteenth embodiment of the design of FIG. 41, the only difference being in the placement of the cutouts in the base;

FIG. 49 is a side elevational view of a nineteenth embodiment of the design of FIG. 41, the only difference being in the placement of the cutouts in the base; and,

FIG. 50 is a side elevational view of a twentieth embodiment of the design of FIG. 41, the only difference being in the placement of the cutouts in the base.

The characteristic feature of the design resides in the specific pleating arrangement, comprised of the parallel disposition of the exterior folds, in combination with the interior V-shaped folds, all as best seen in FIGS. 1, 11, 21, 31 and 41.

1 Claim, 10 Drawing Sheets

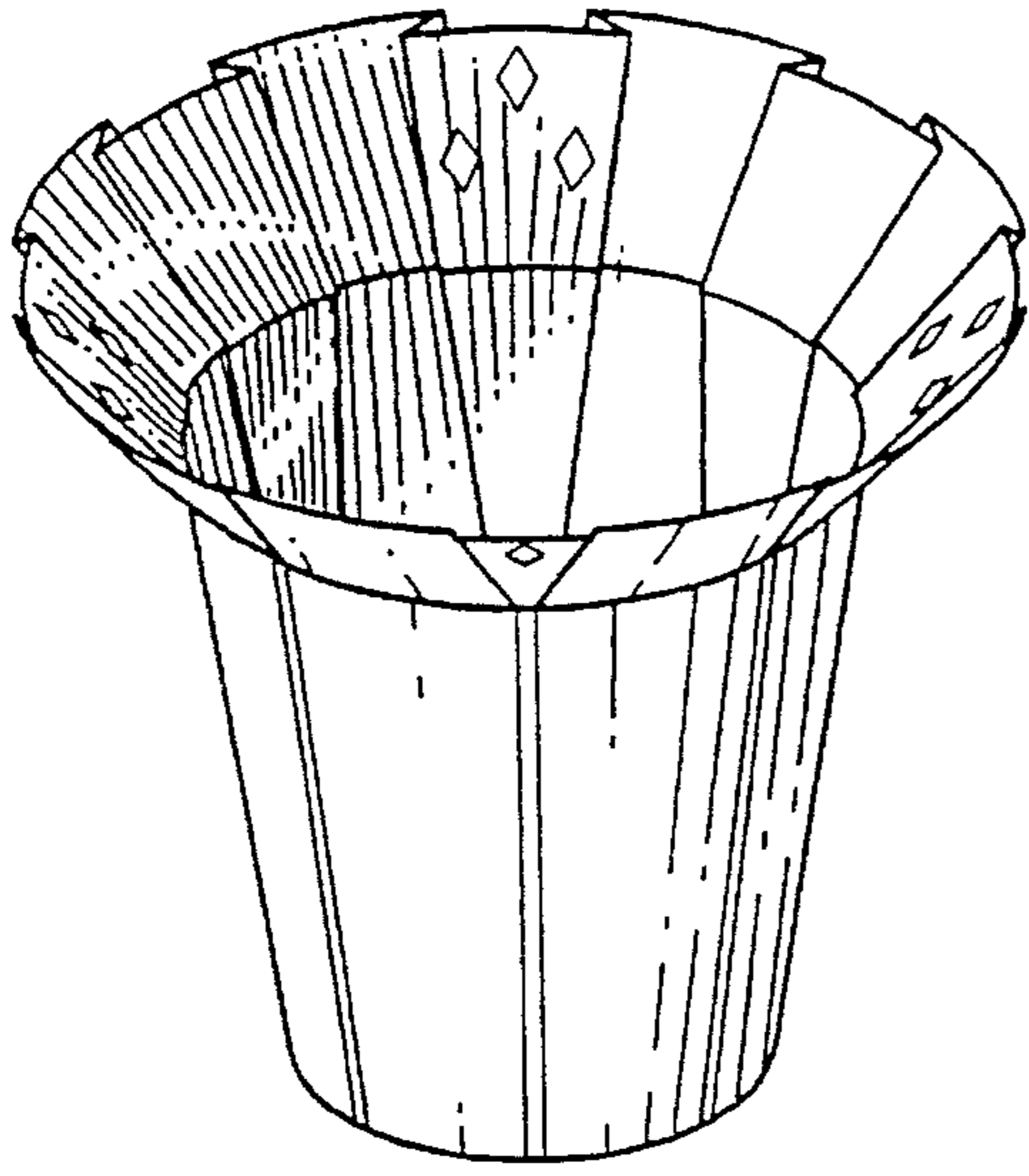

FIG. 1

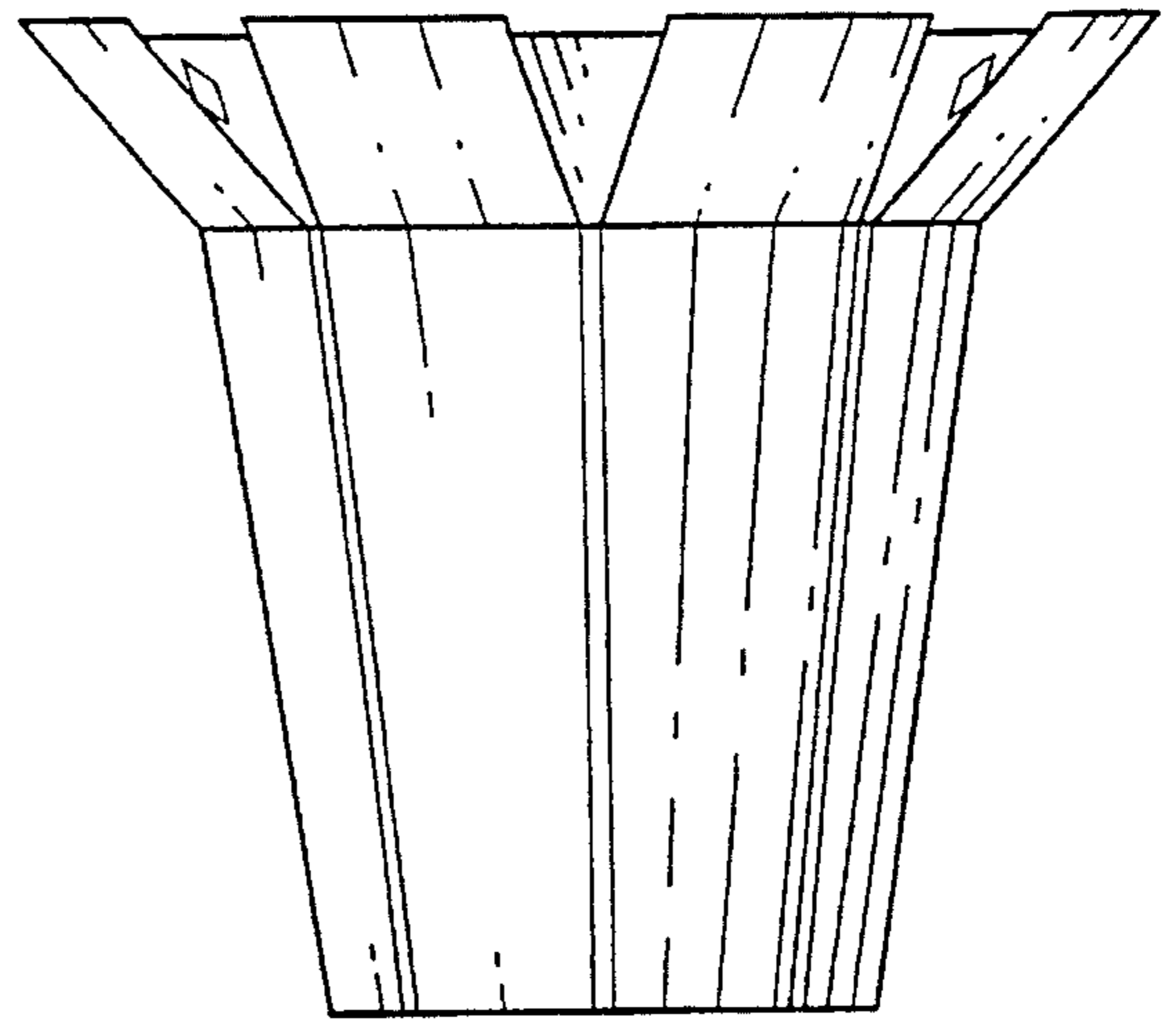

FIG. 2

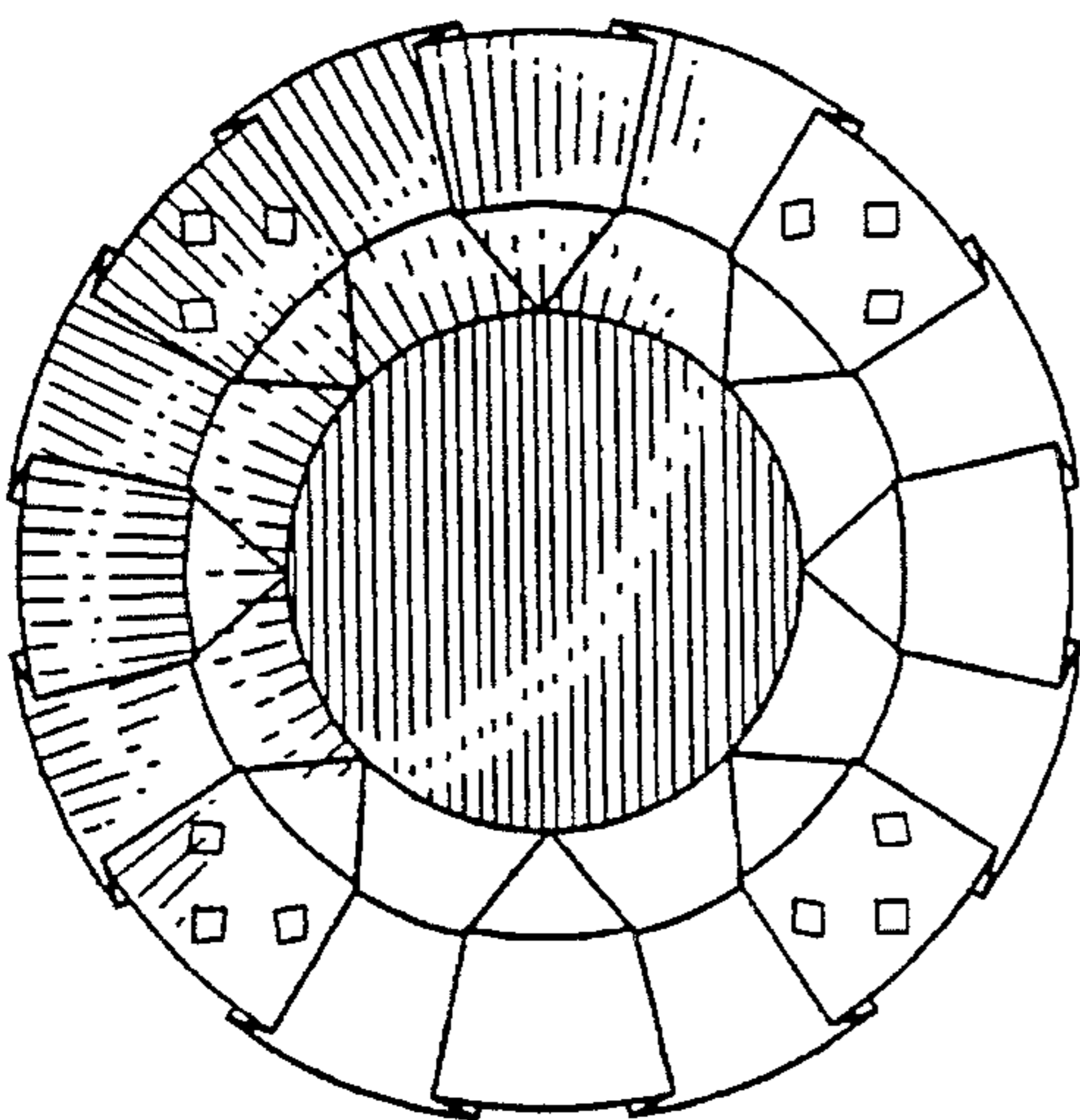

FIG. 3

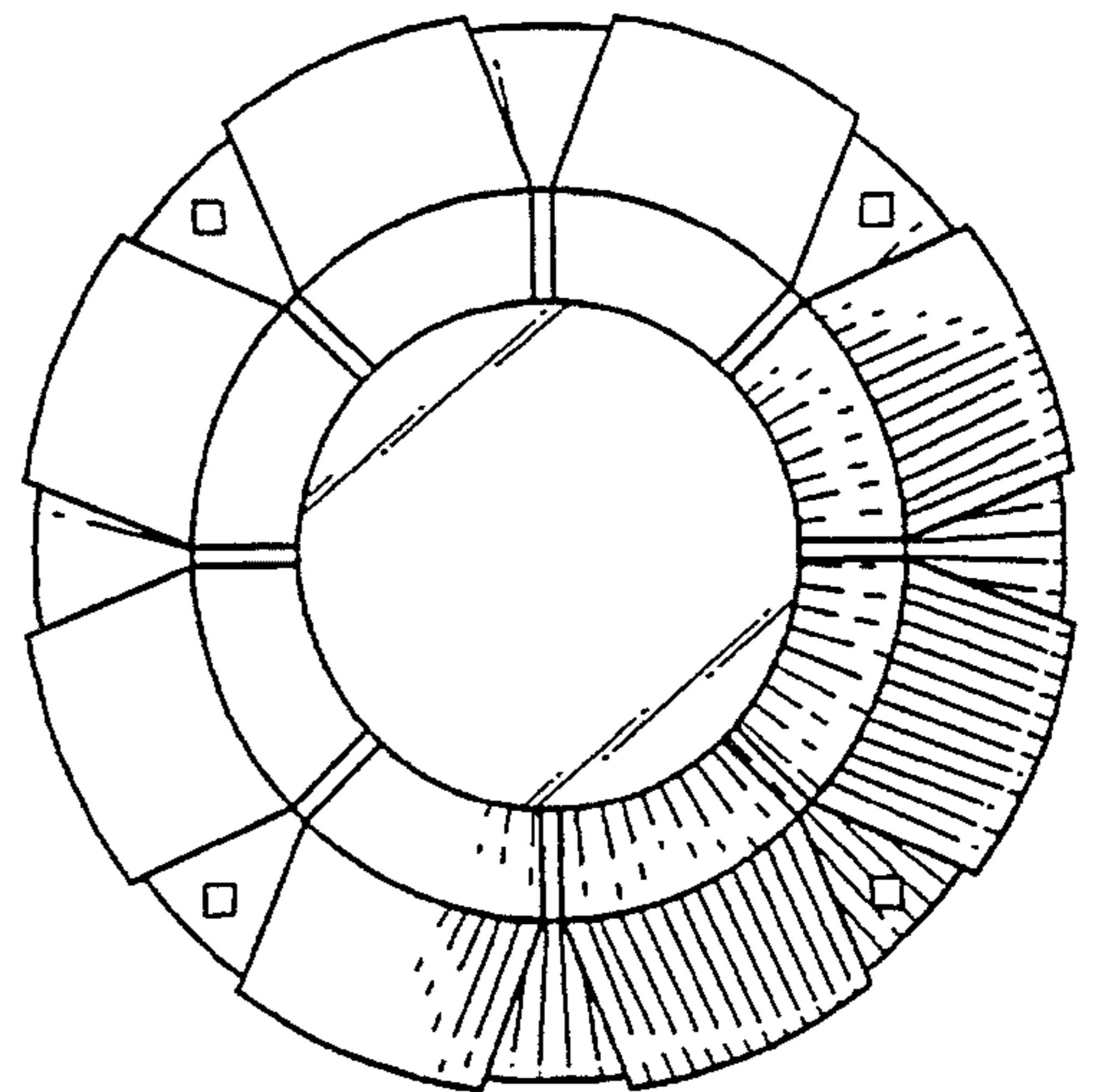

FIG. 4

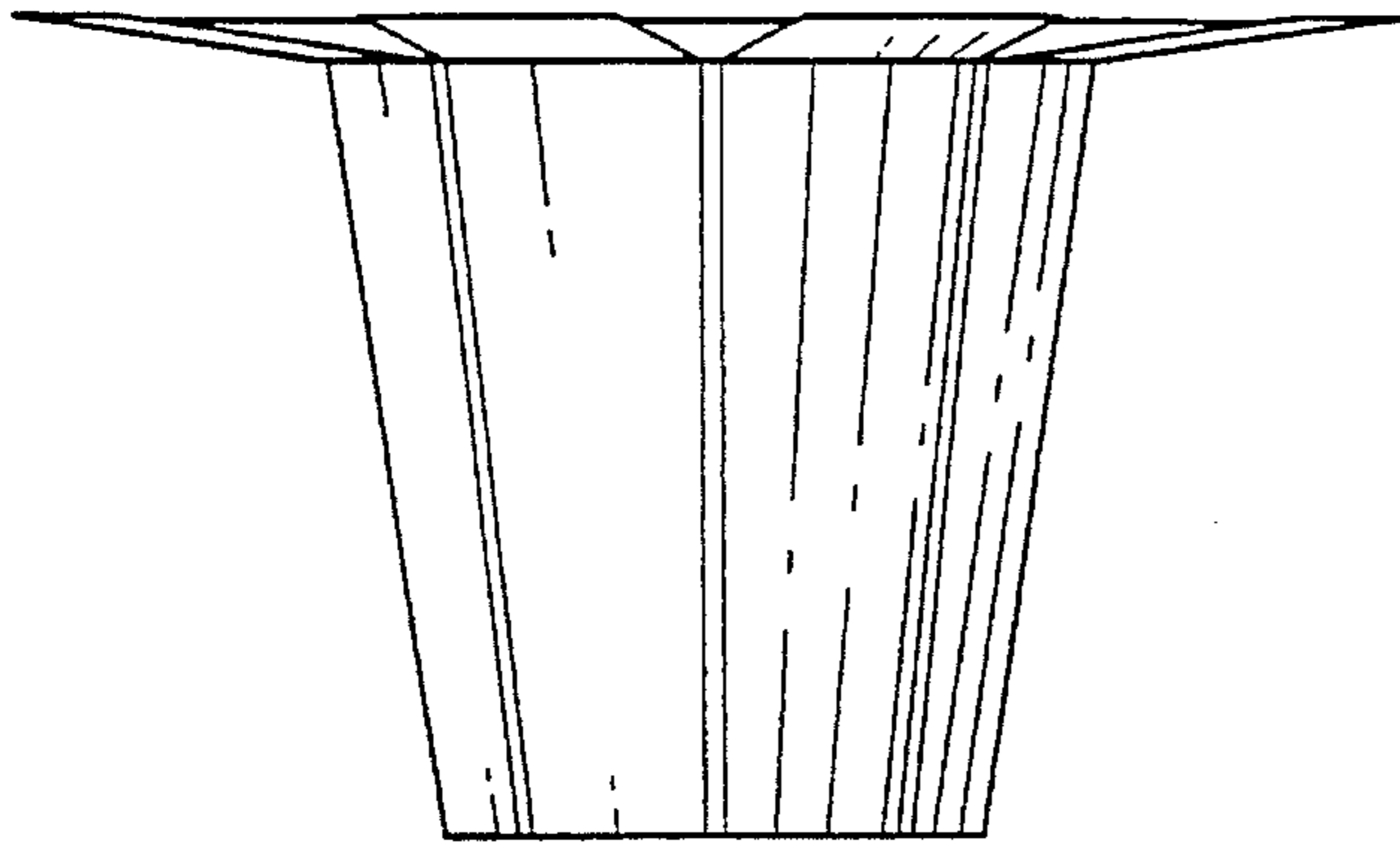

FIG. 1

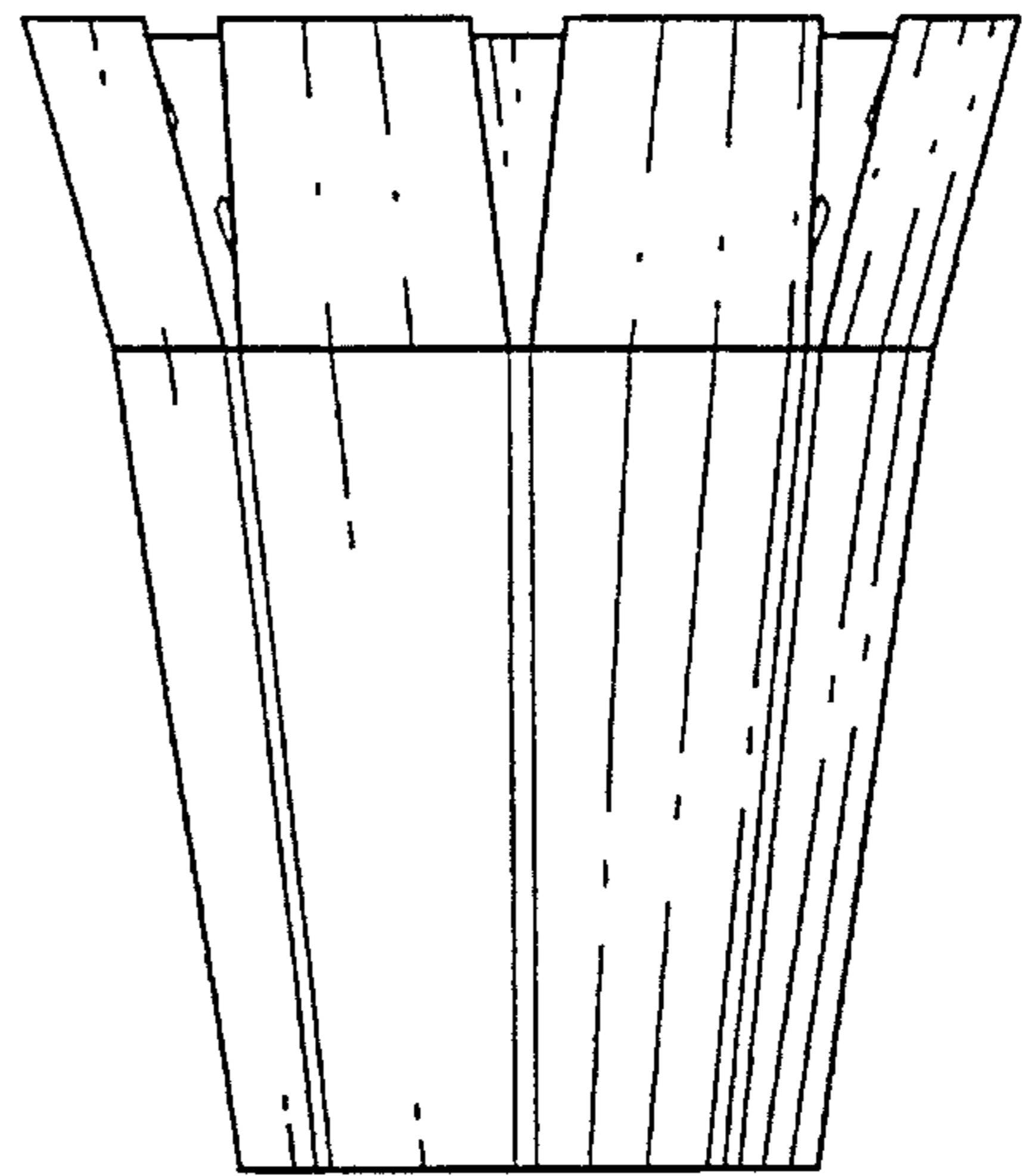

FIG. 2

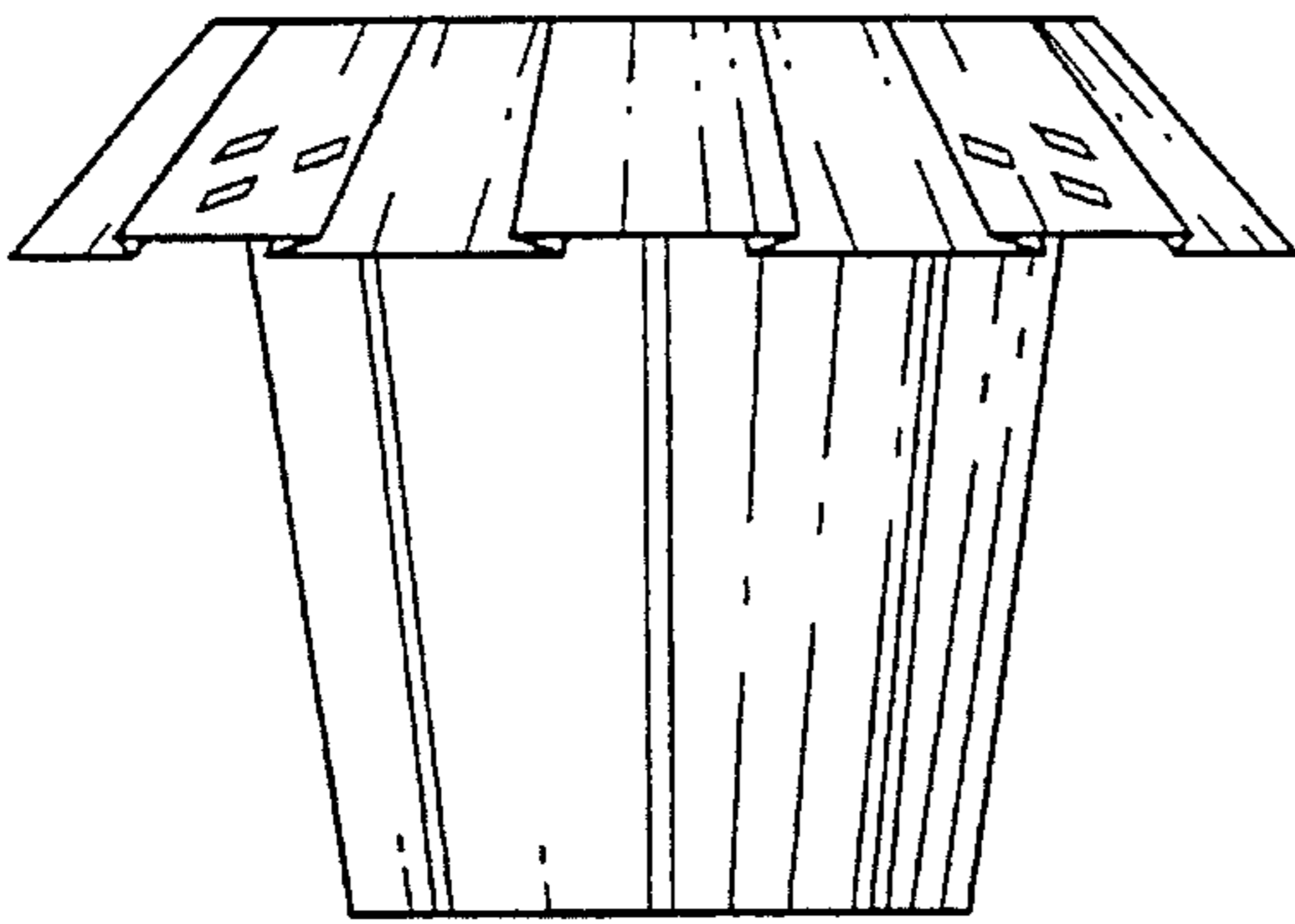

FIG. 3

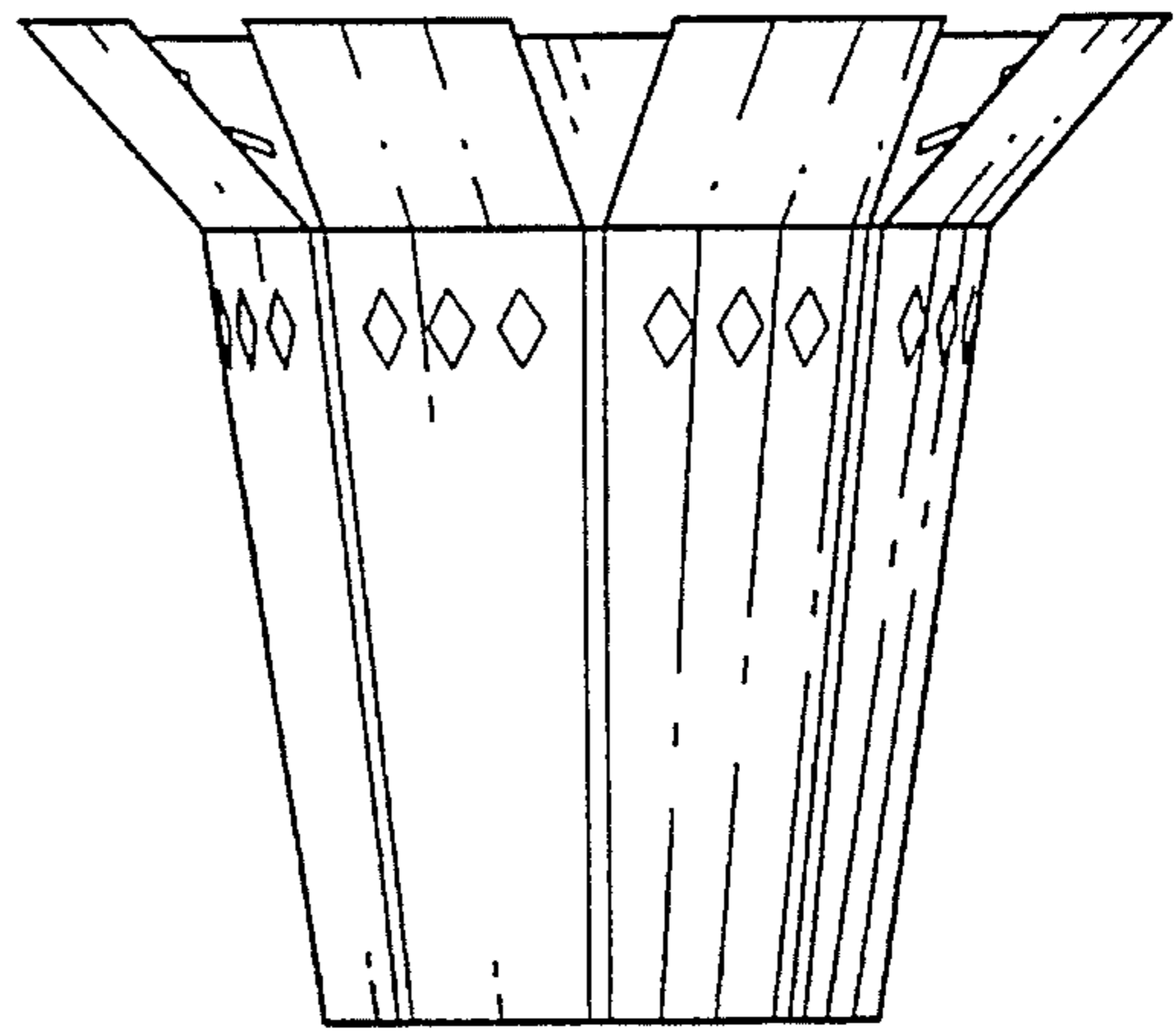

FIG. 4

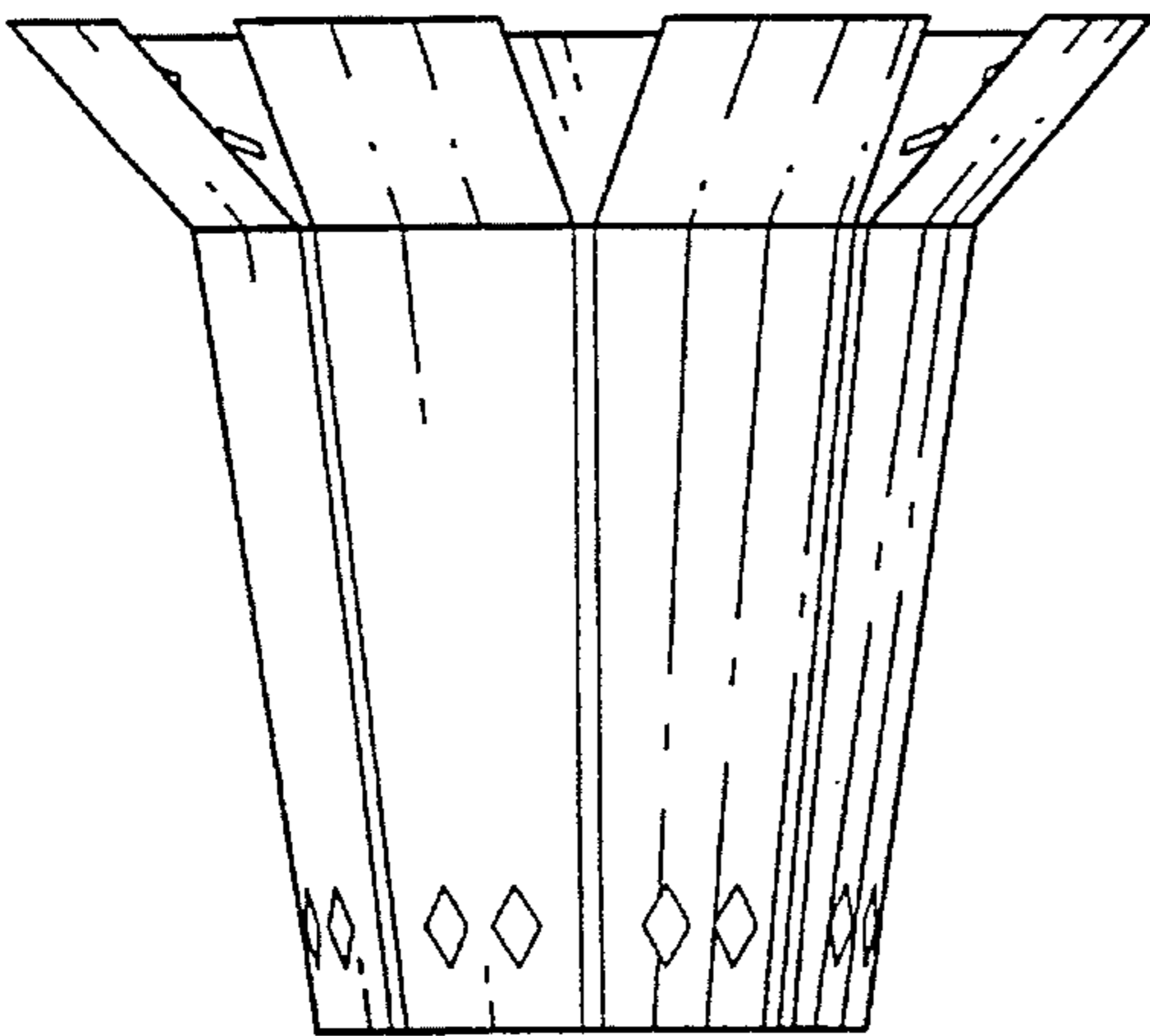

FIG. 5

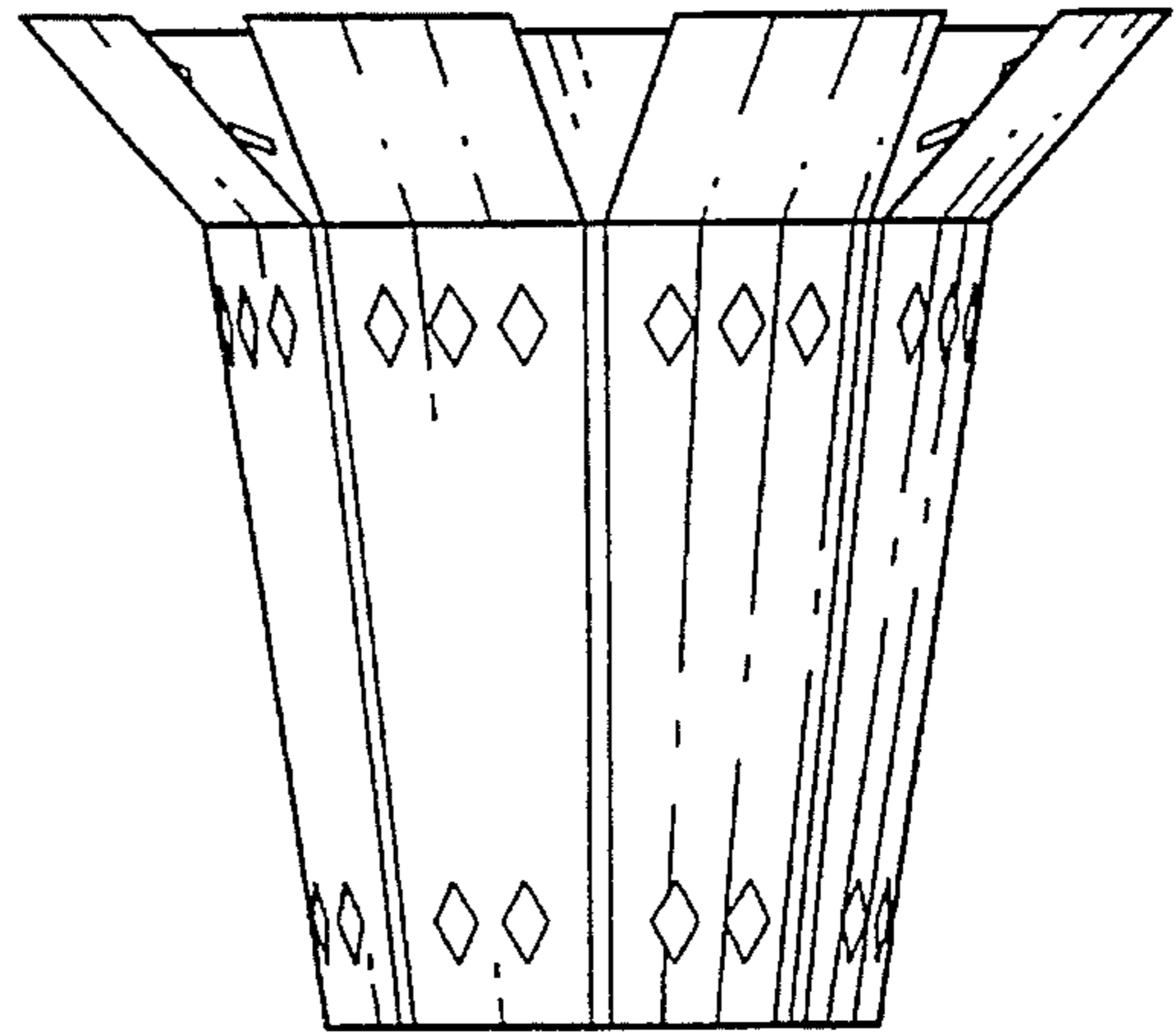

FIG. 6

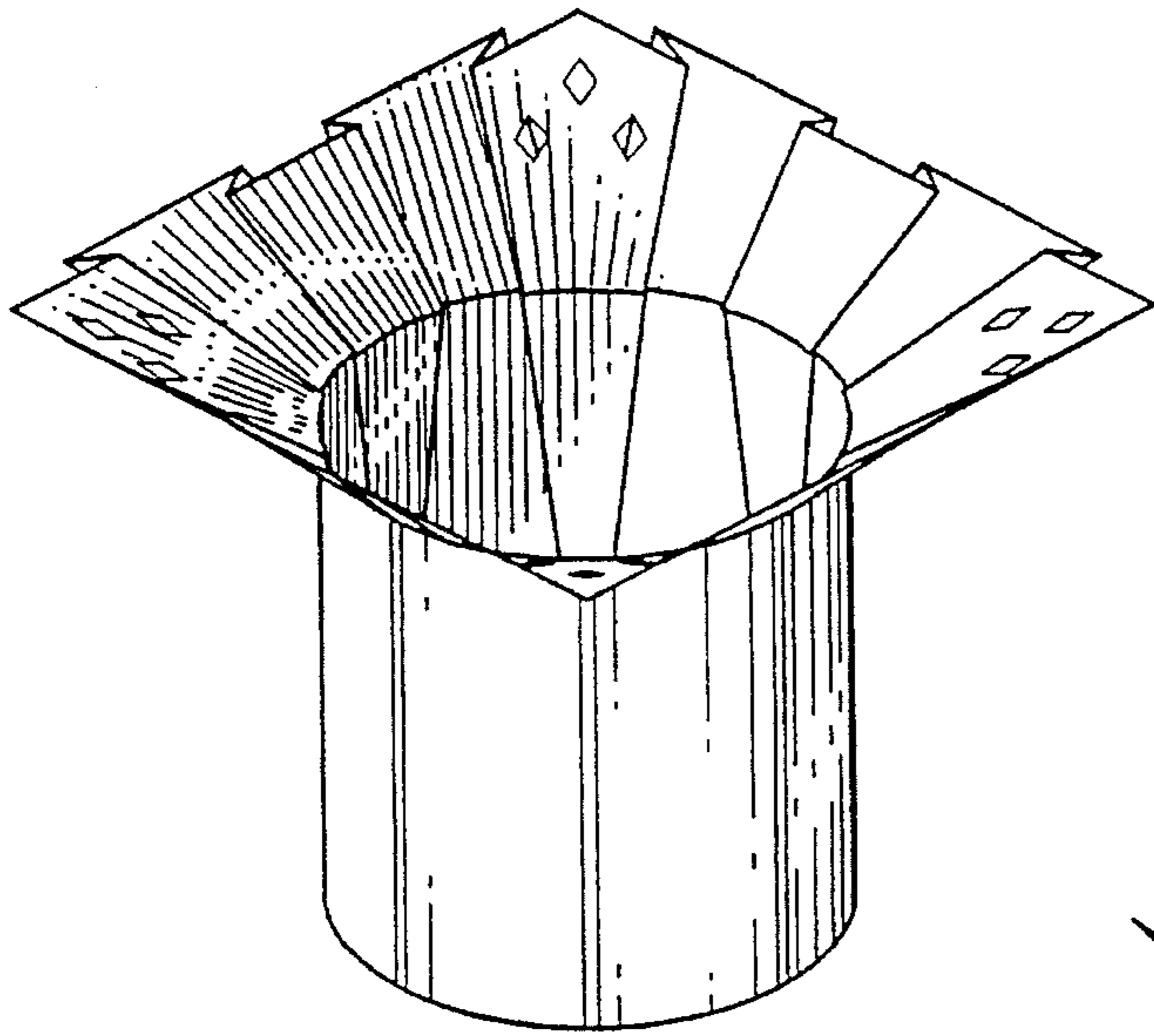

FIG. 11

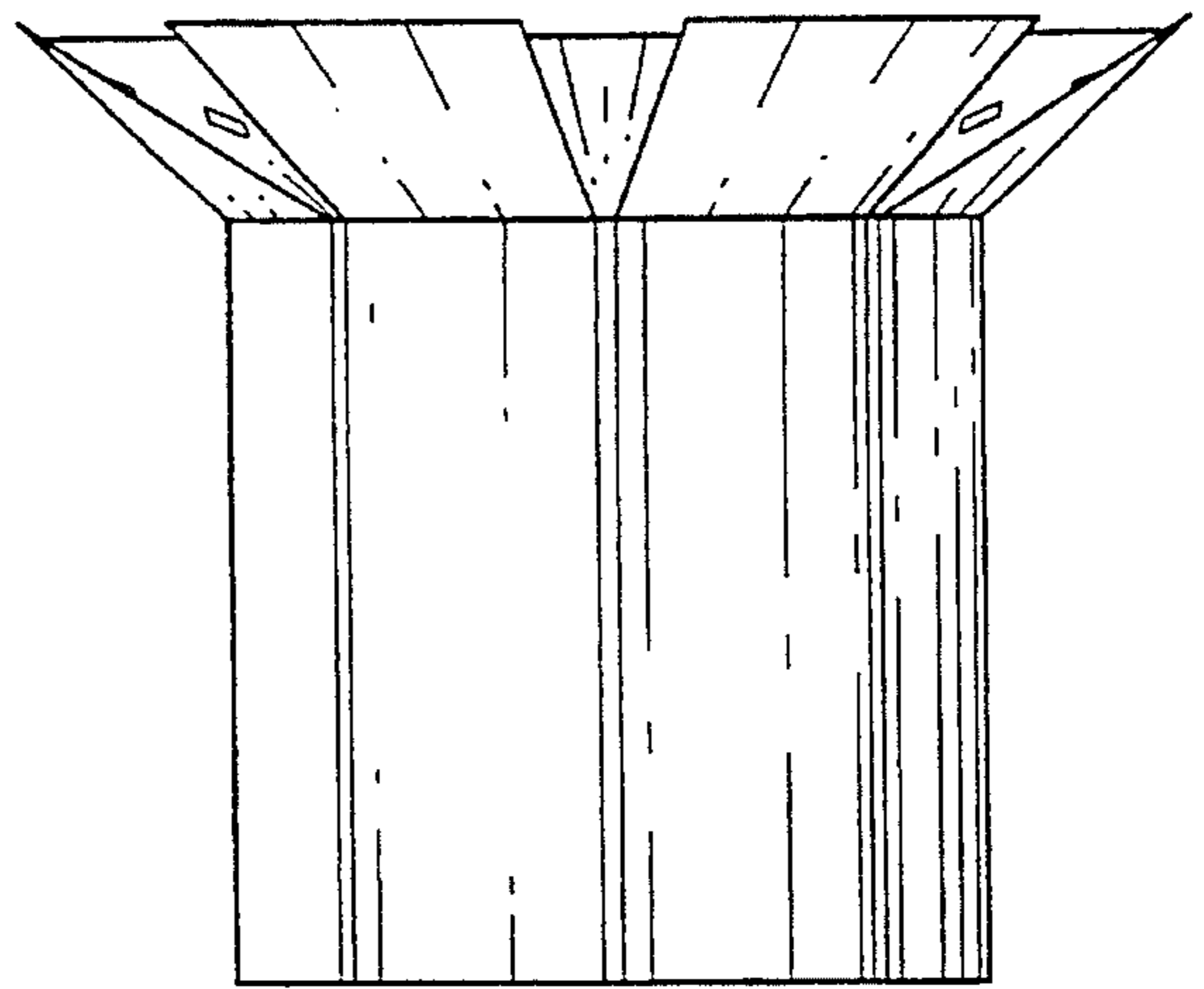

FIG. 12

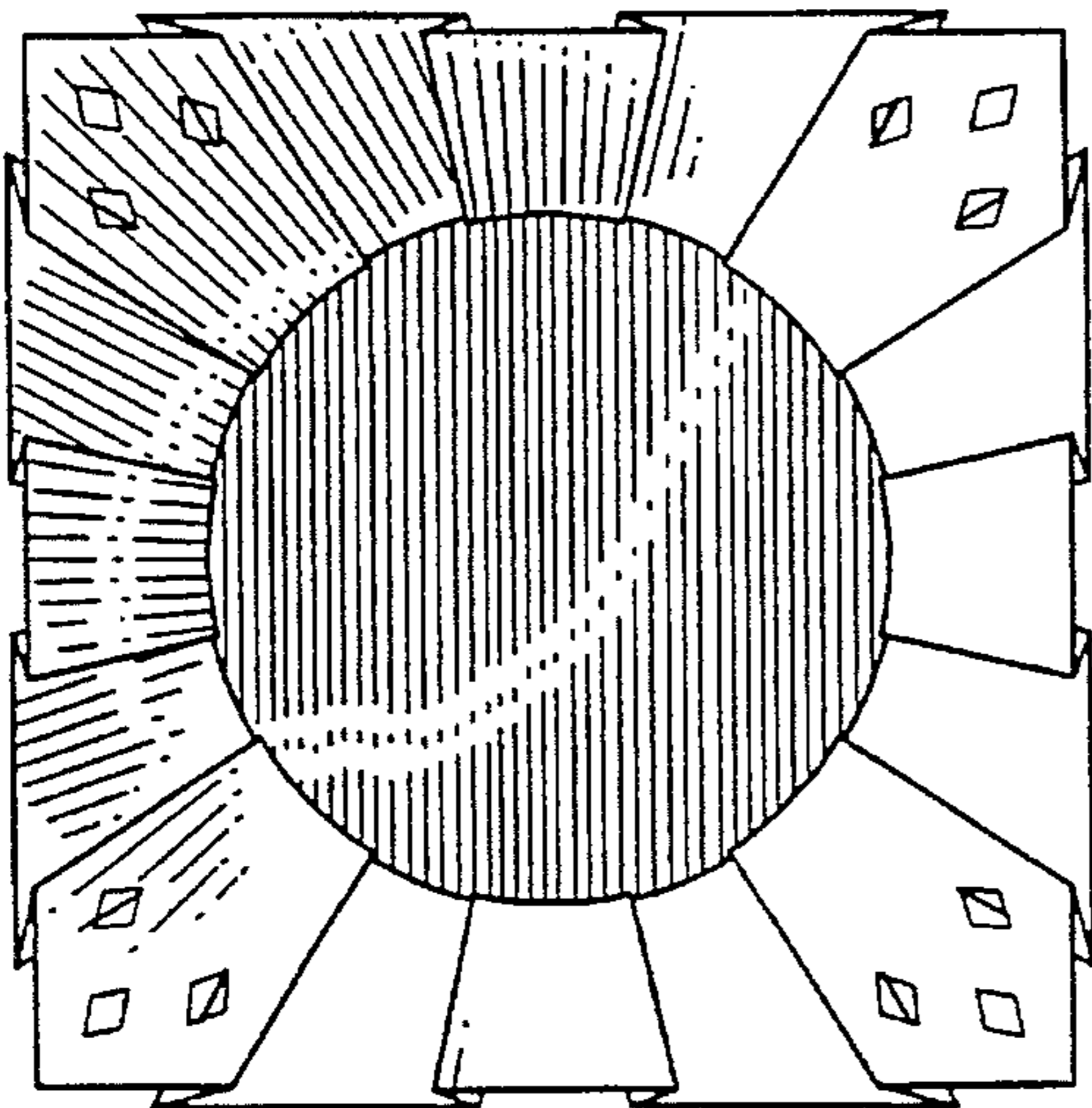

FIG. 13

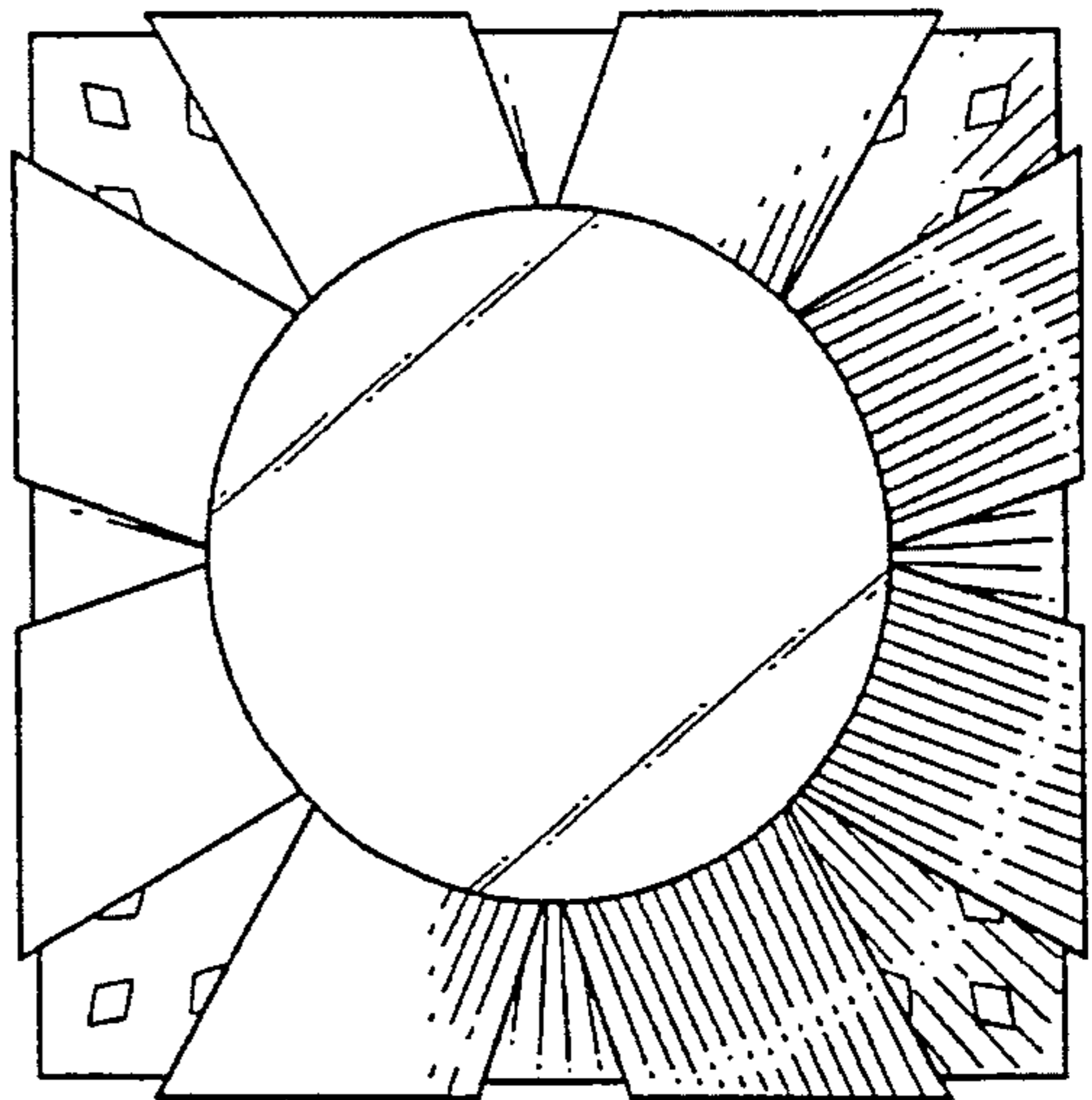

FIG. 14

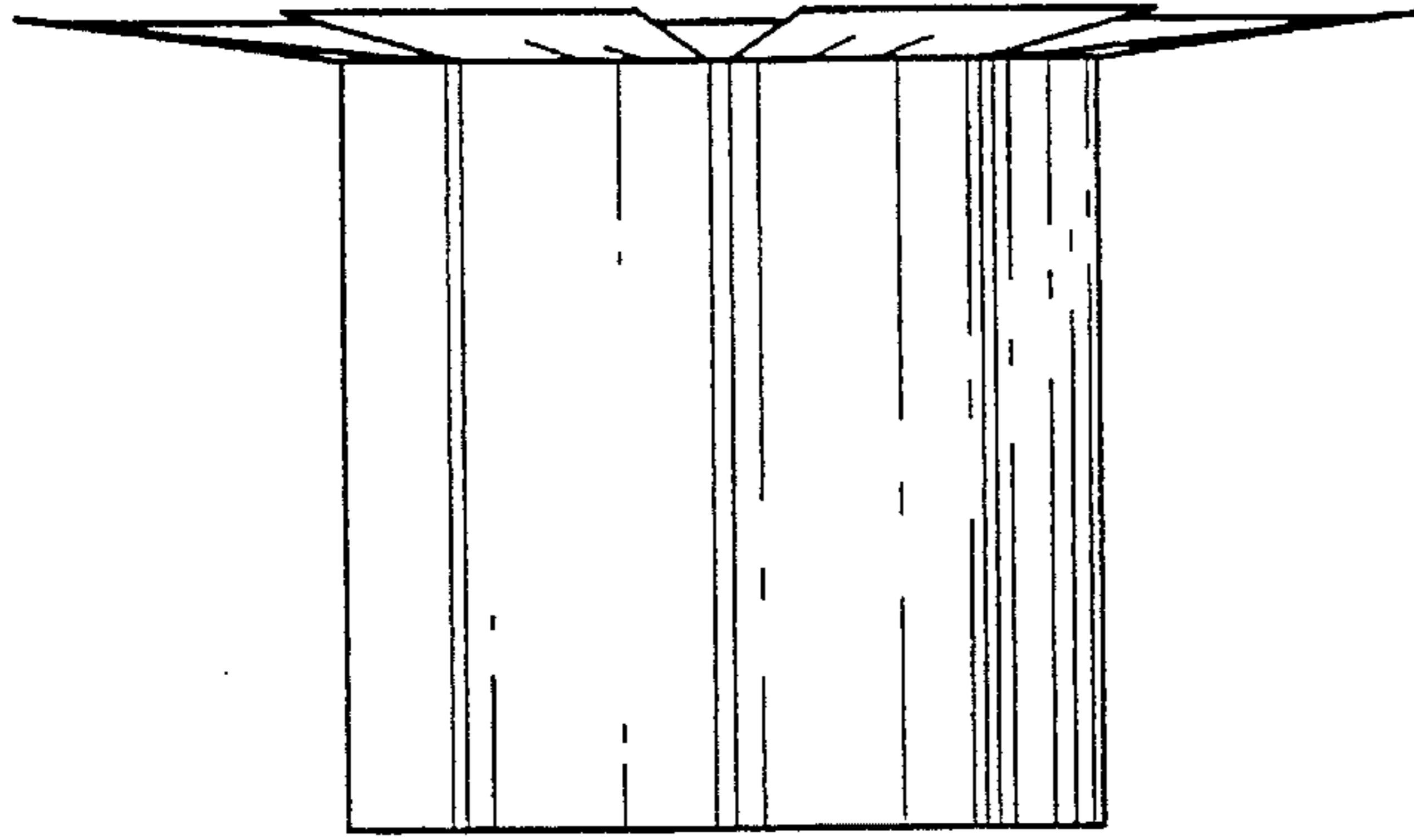

FIG. 15

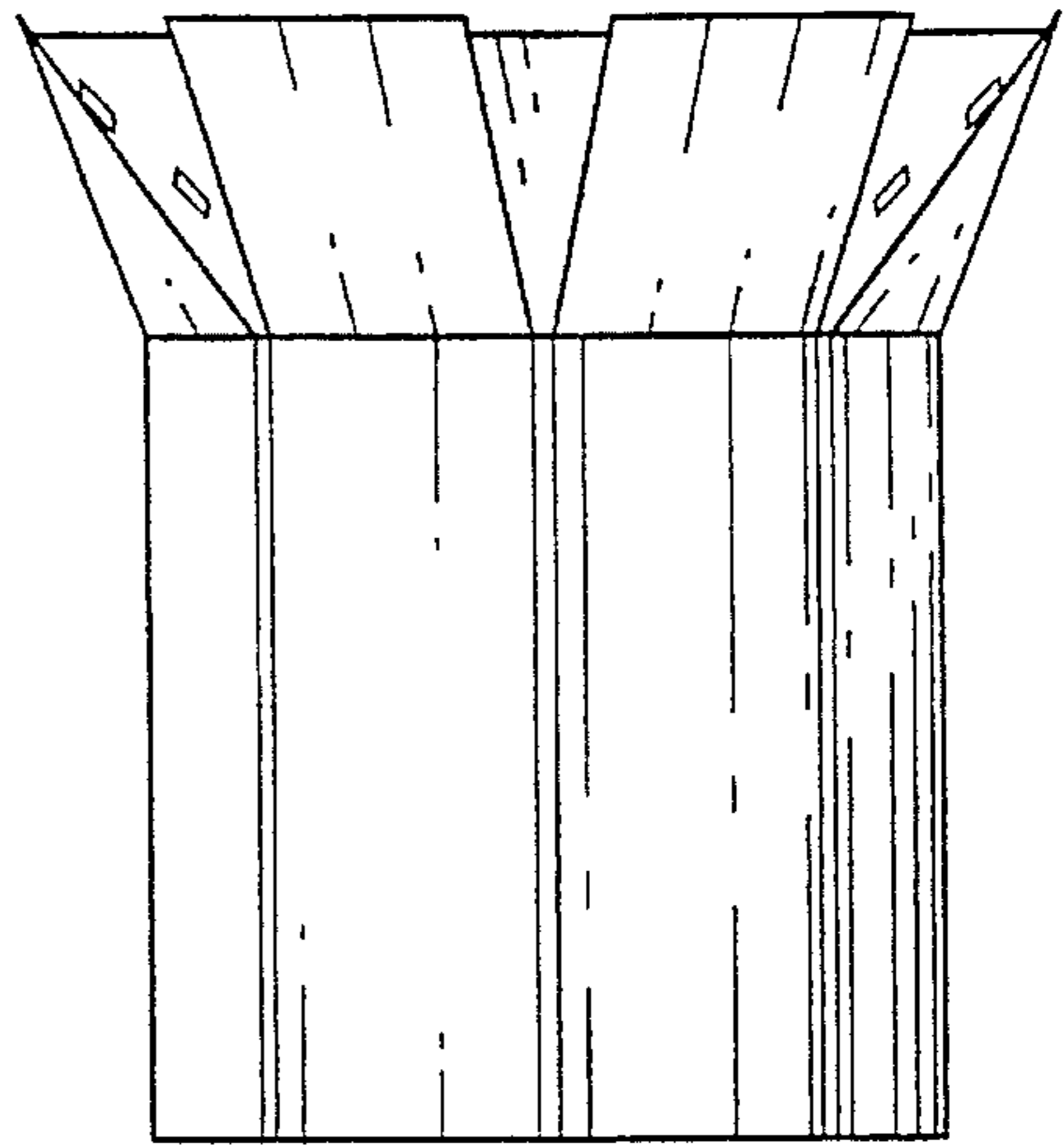

FIG. 16

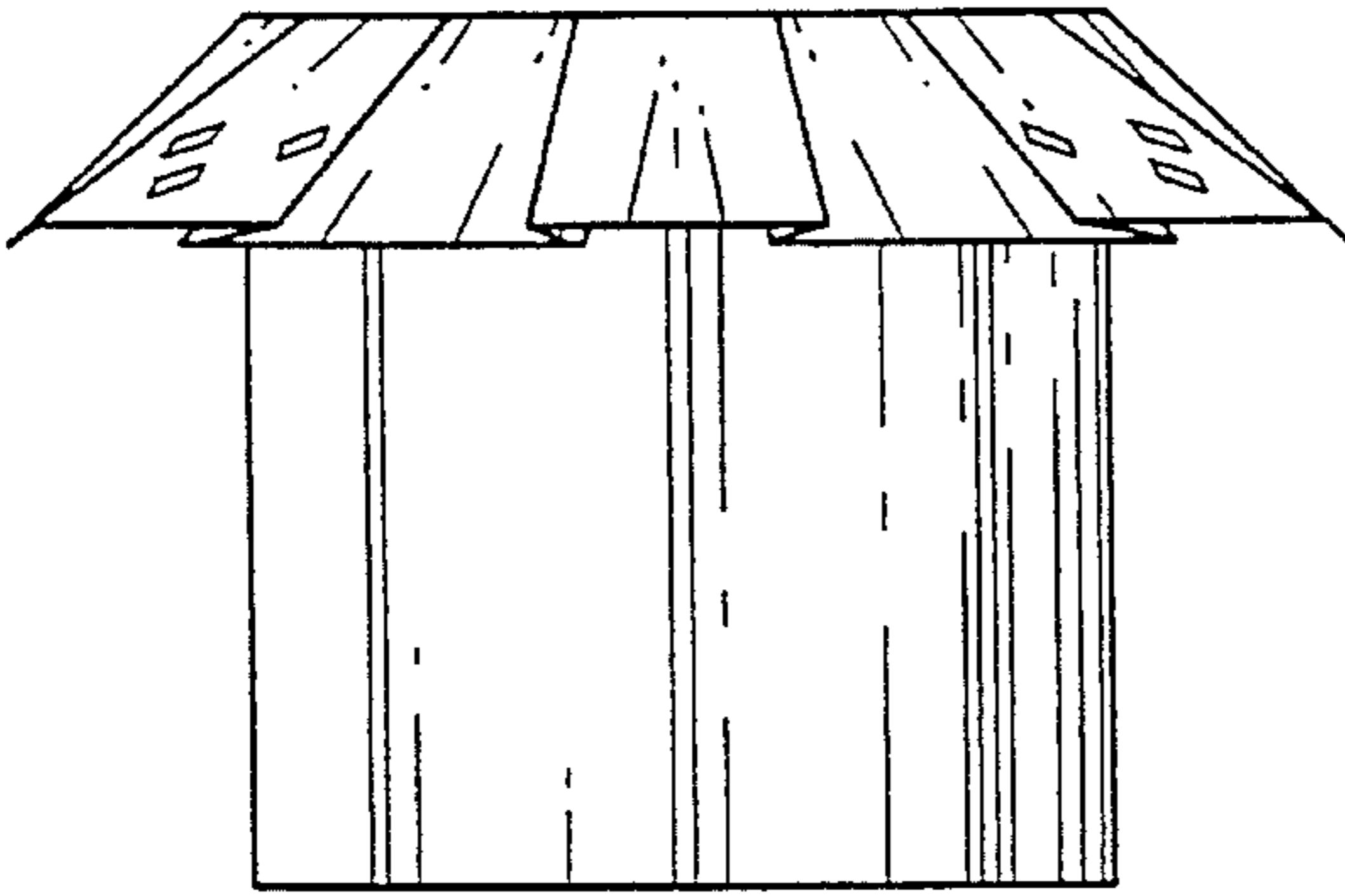

FIG. 17

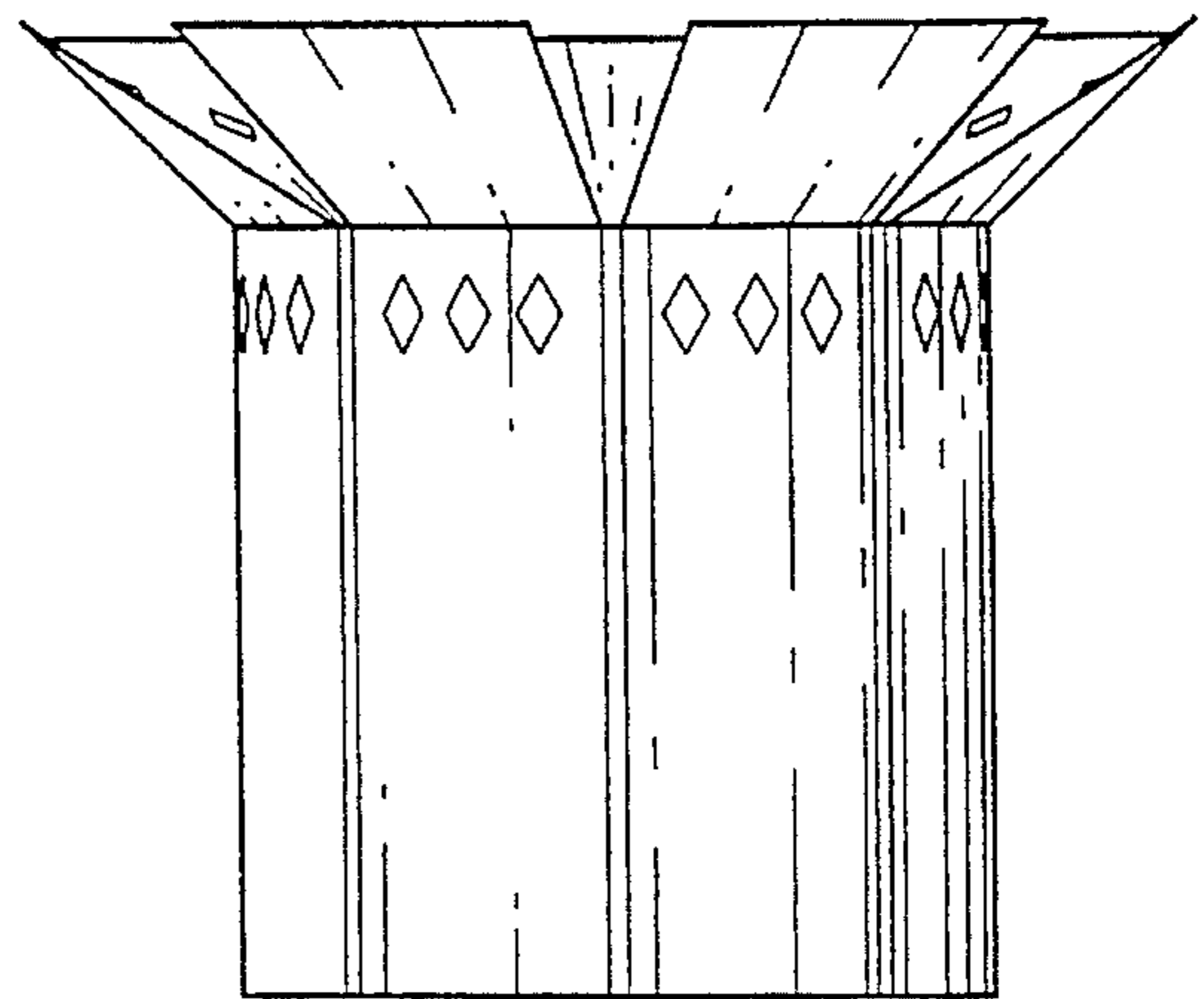

FIG. 18

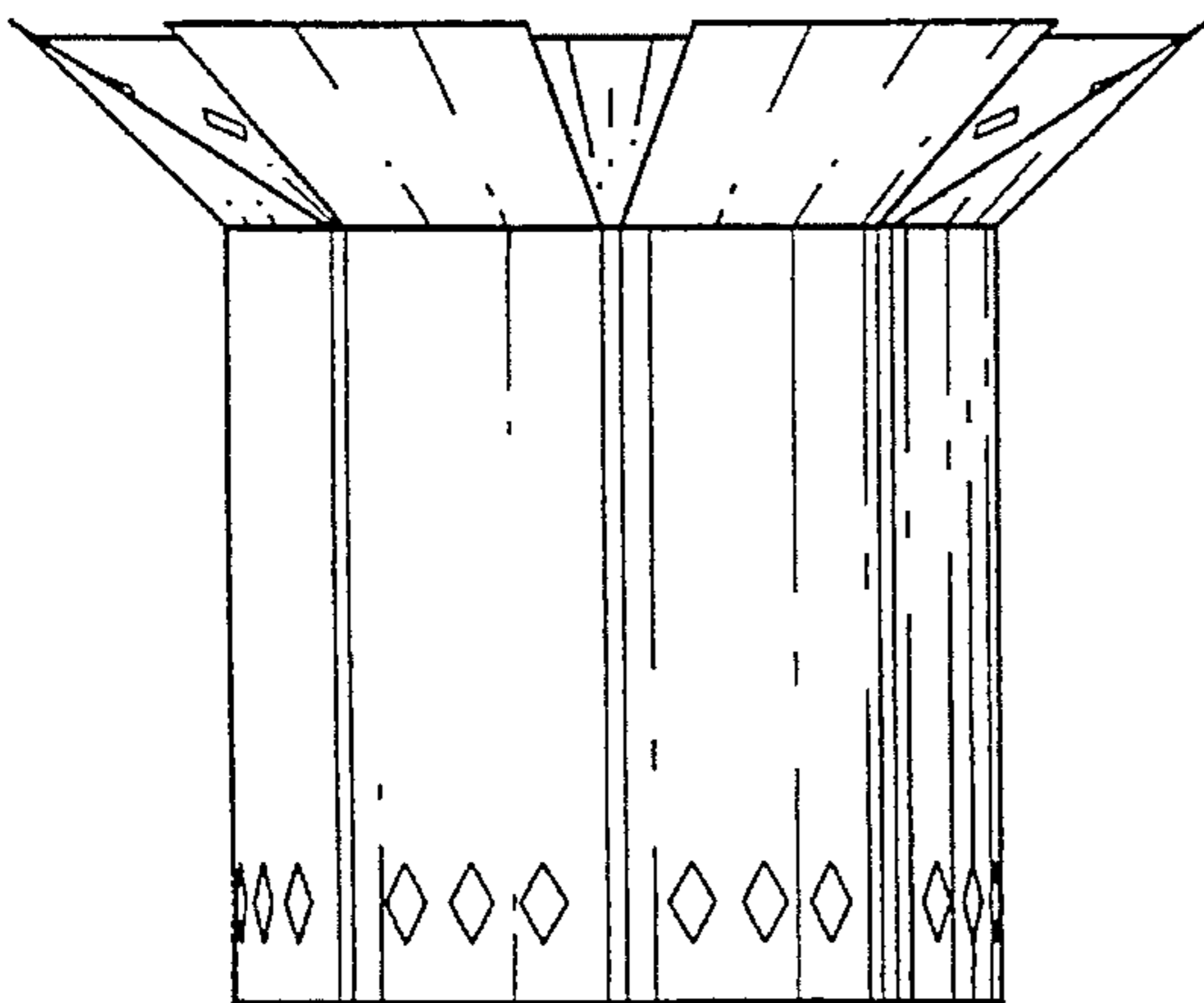

FIG. 19

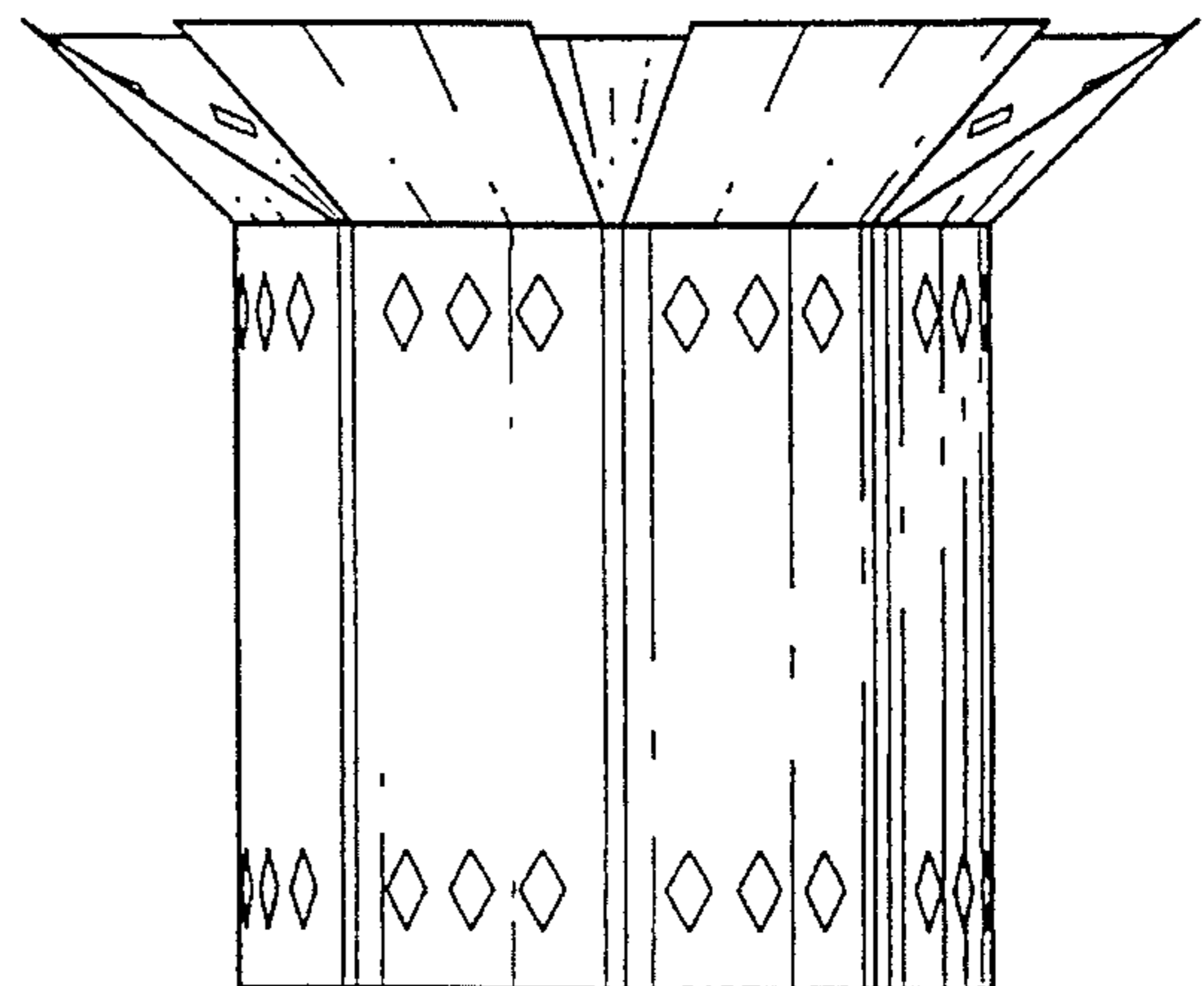

FIG. 20

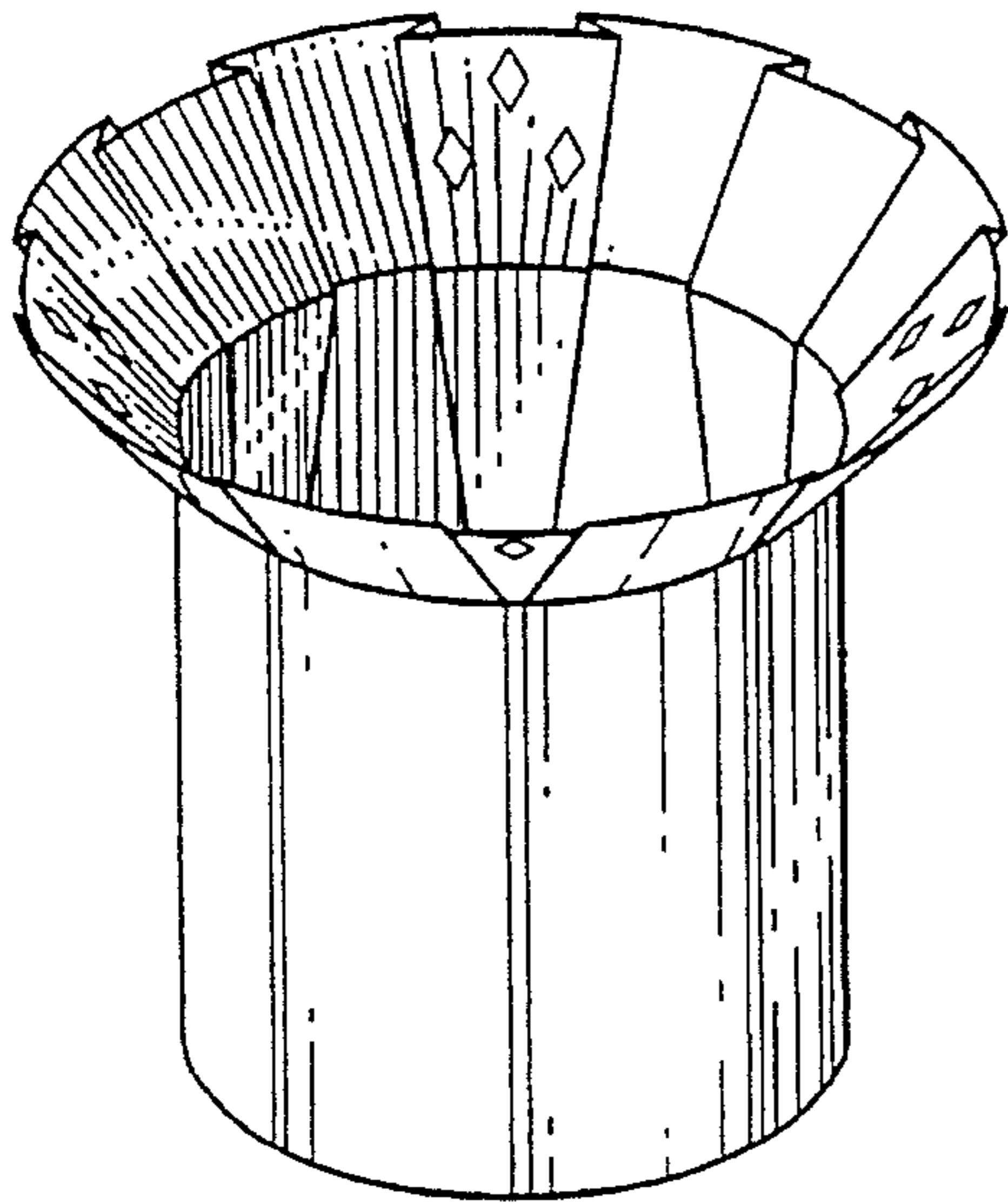

FIG. 21

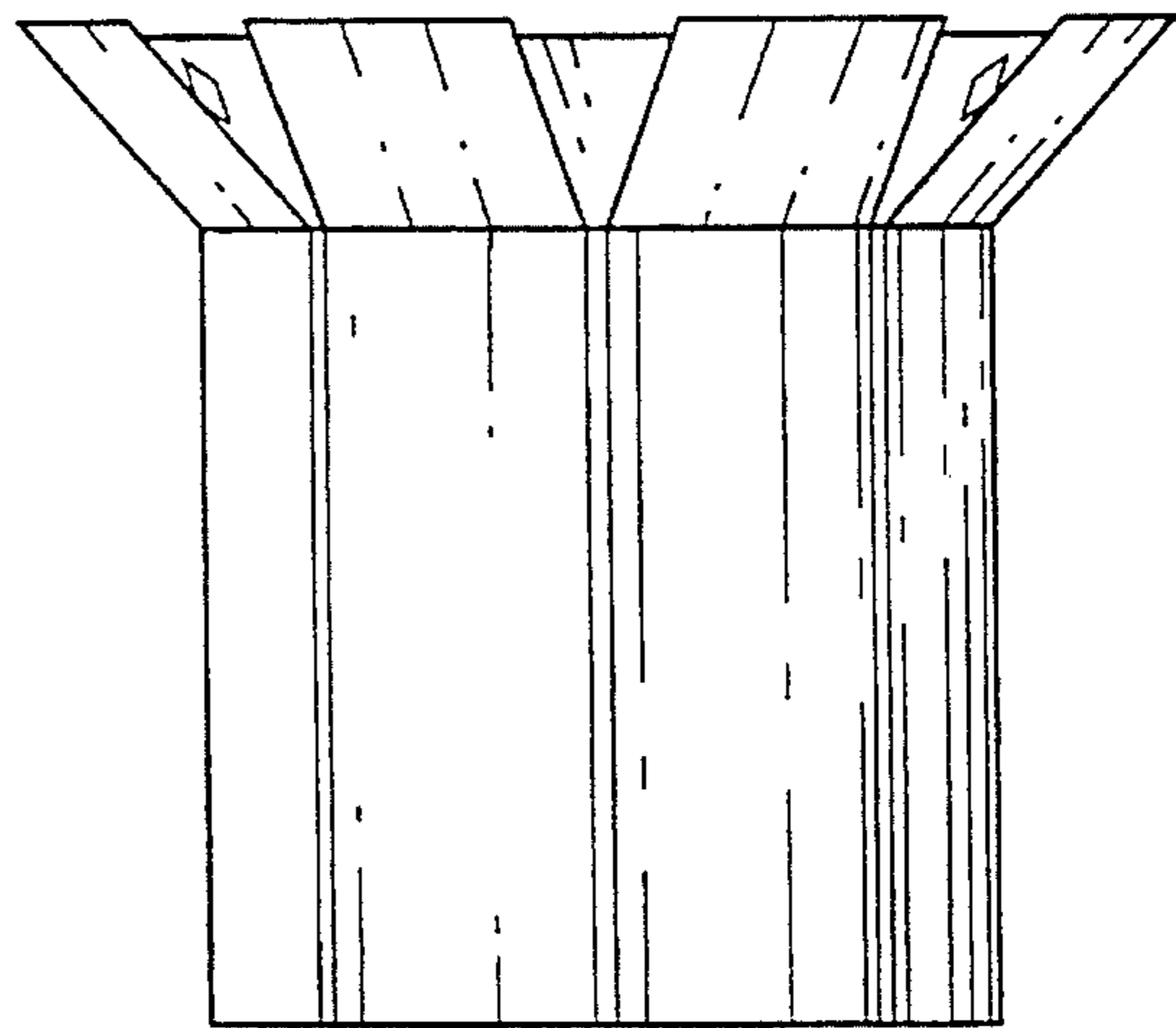

FIG. 22

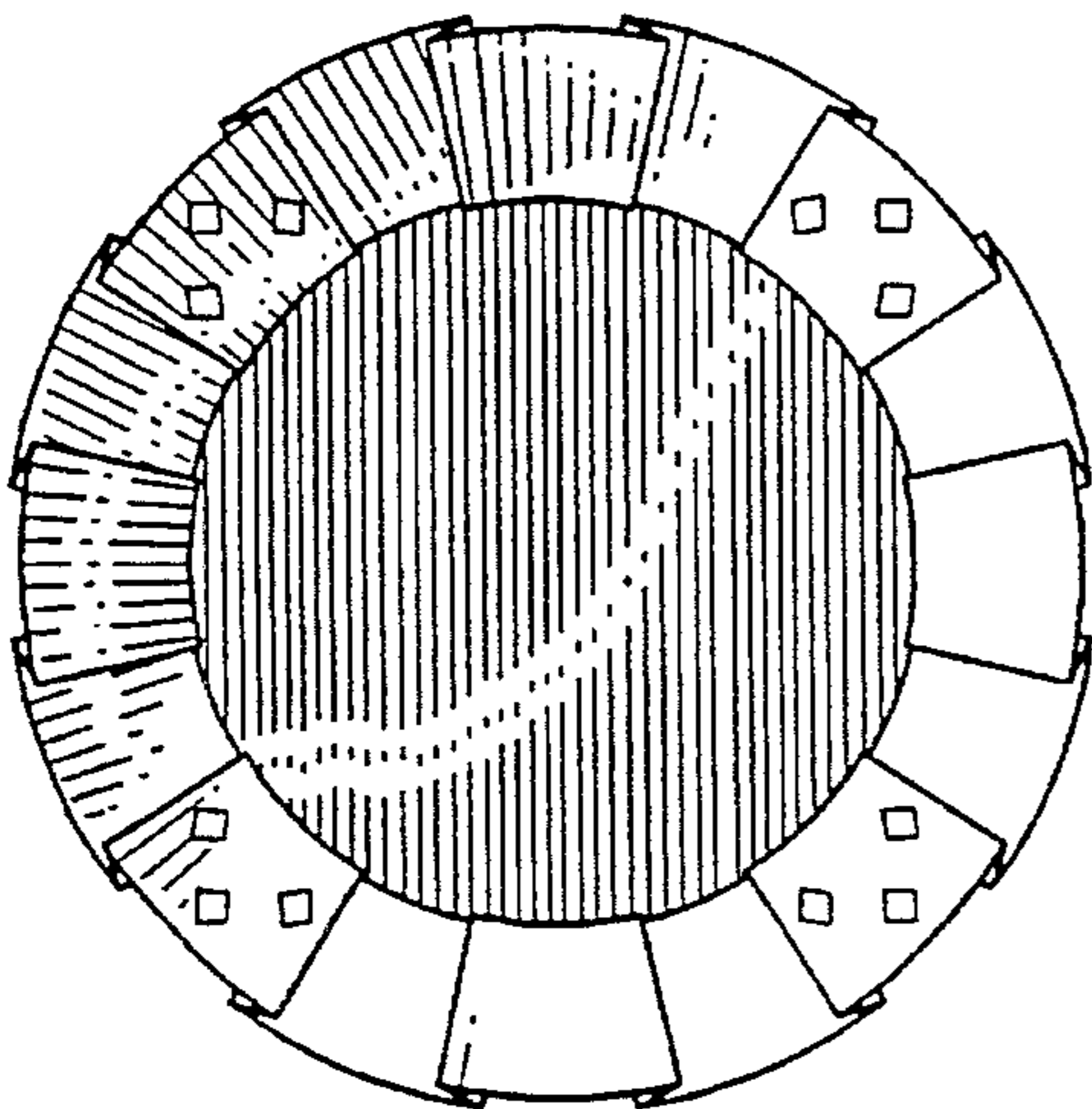

FIG. 23

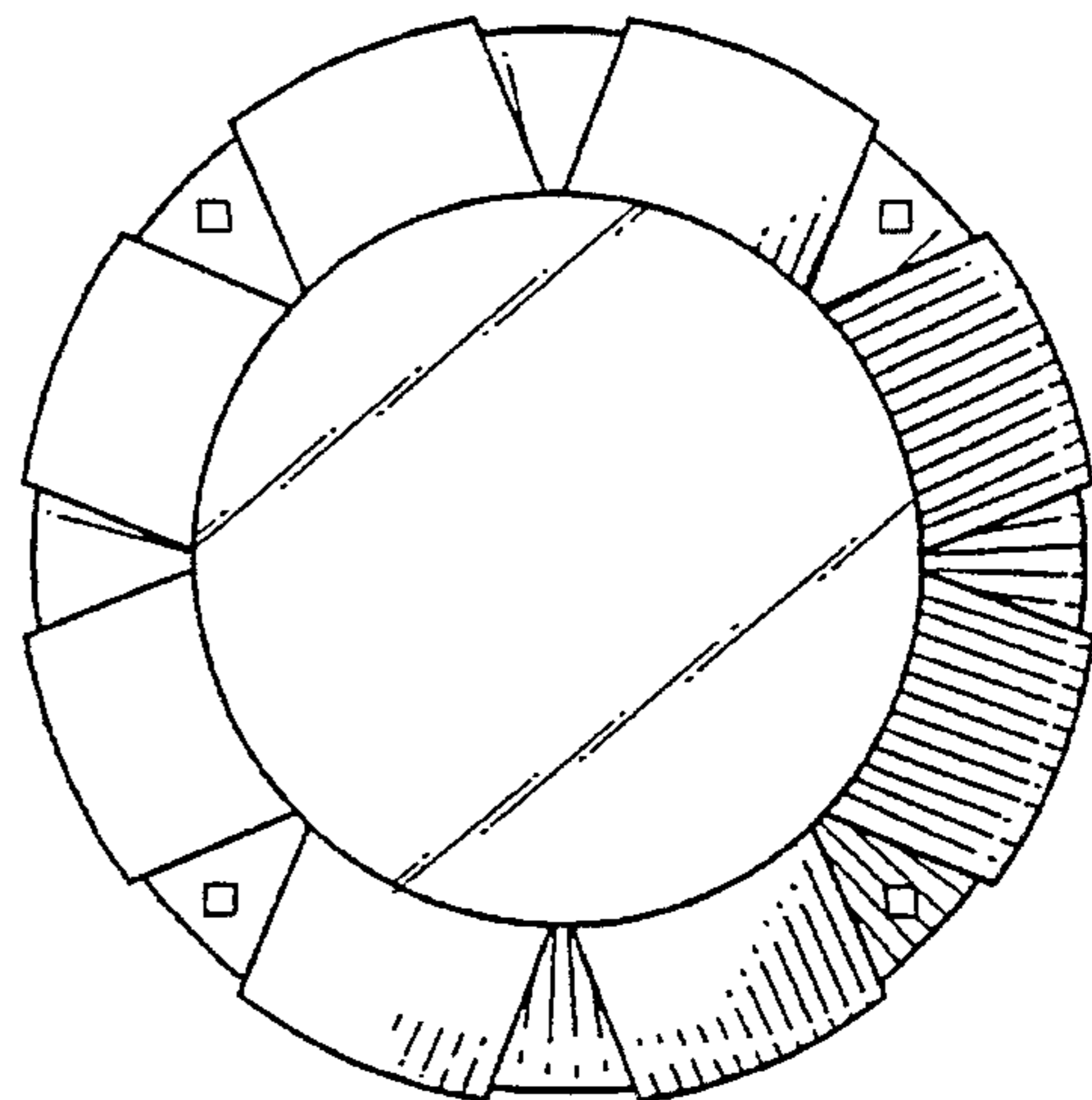

FIG. 24

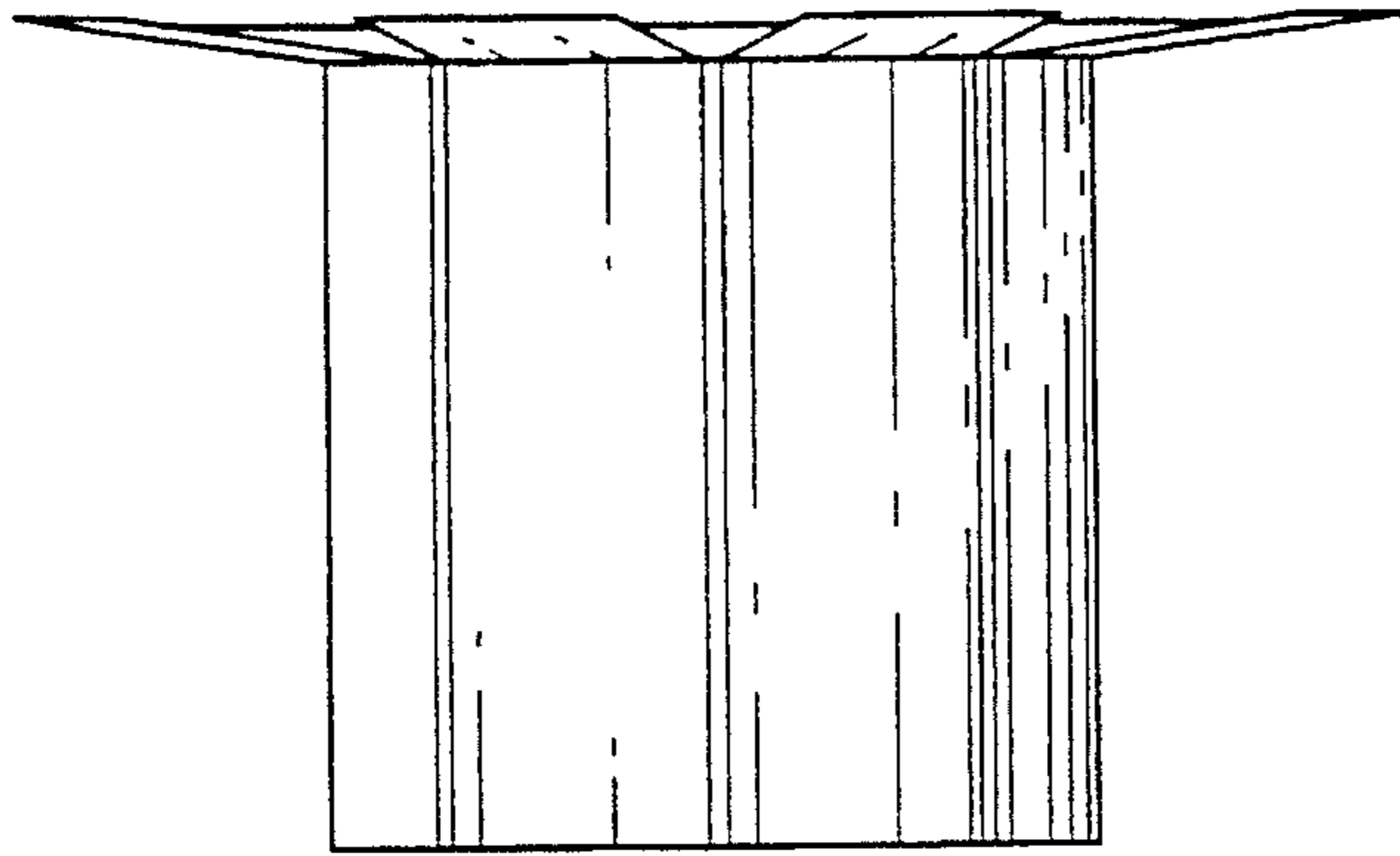

FIG. 25

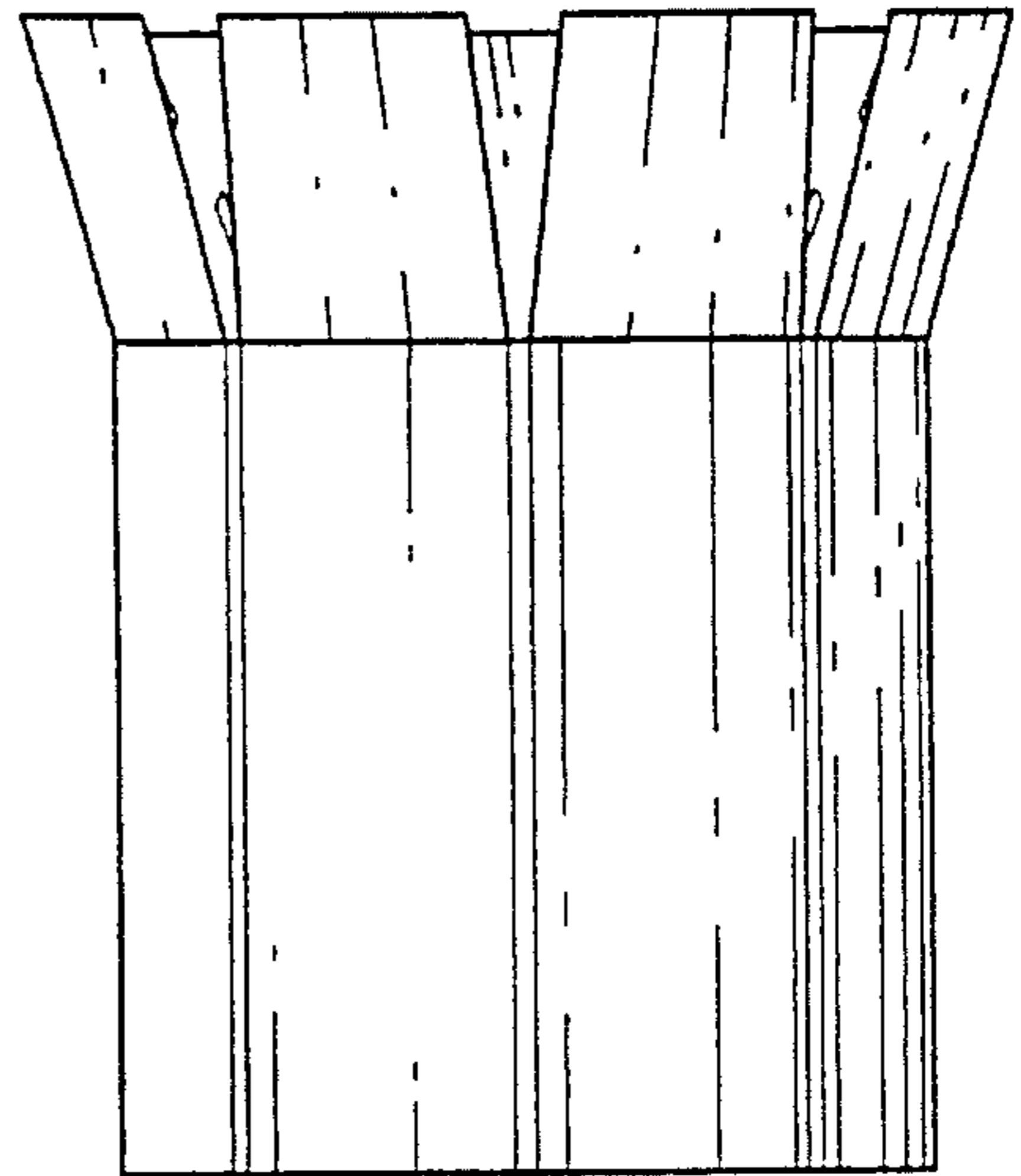

FIG. 26

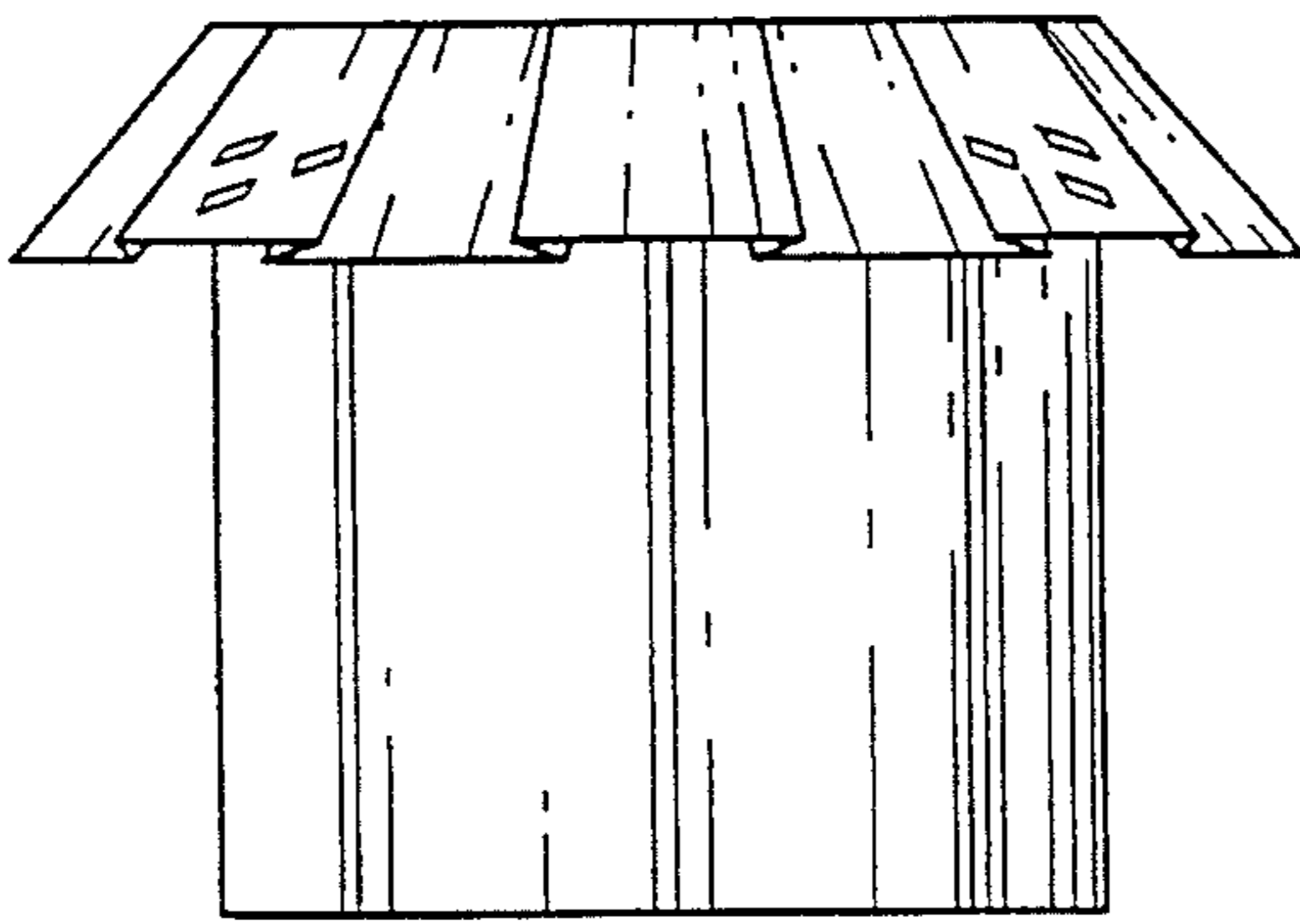

FIG. 27

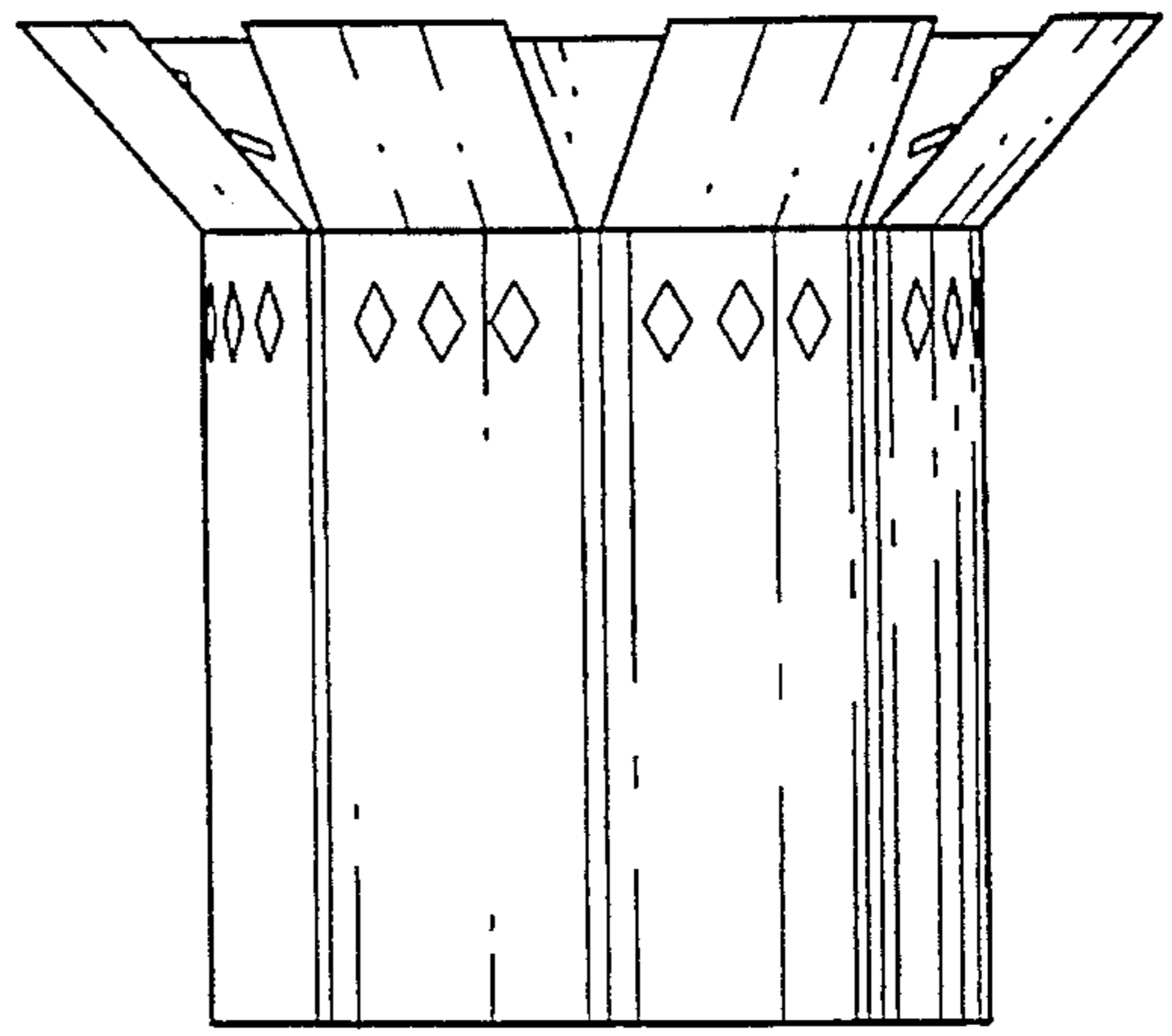

FIG. 28

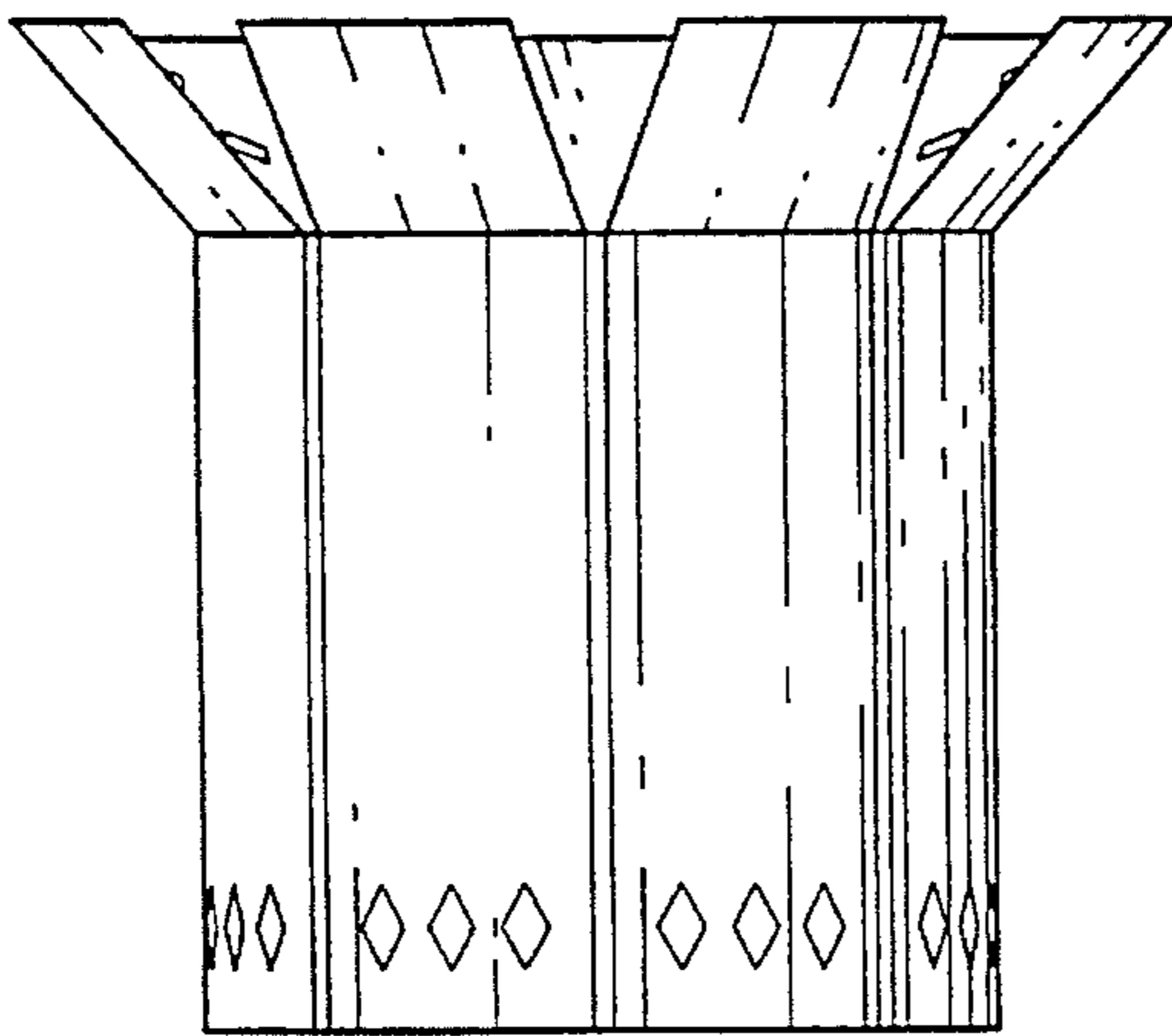

FIG. 29

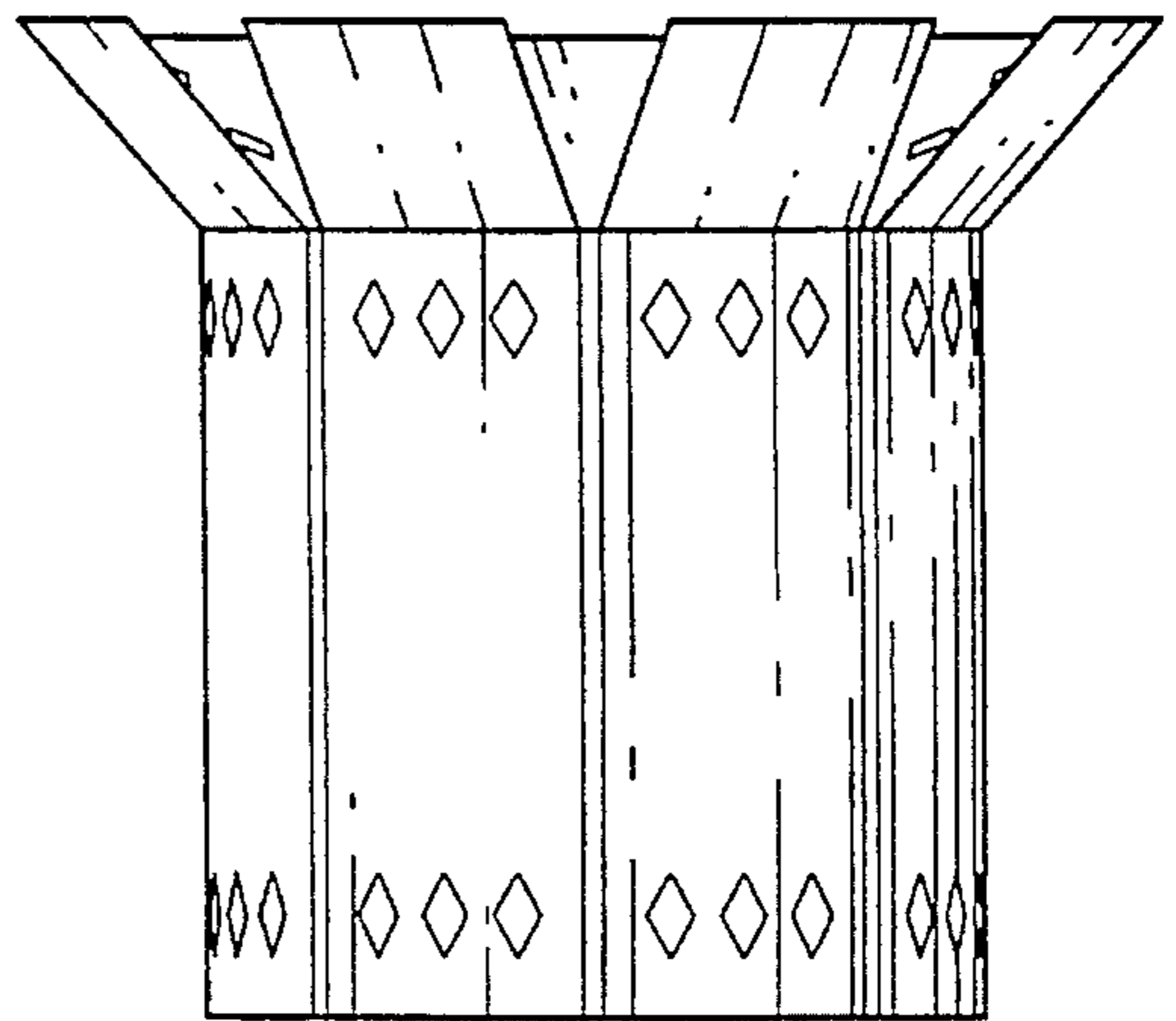

FIG. 30

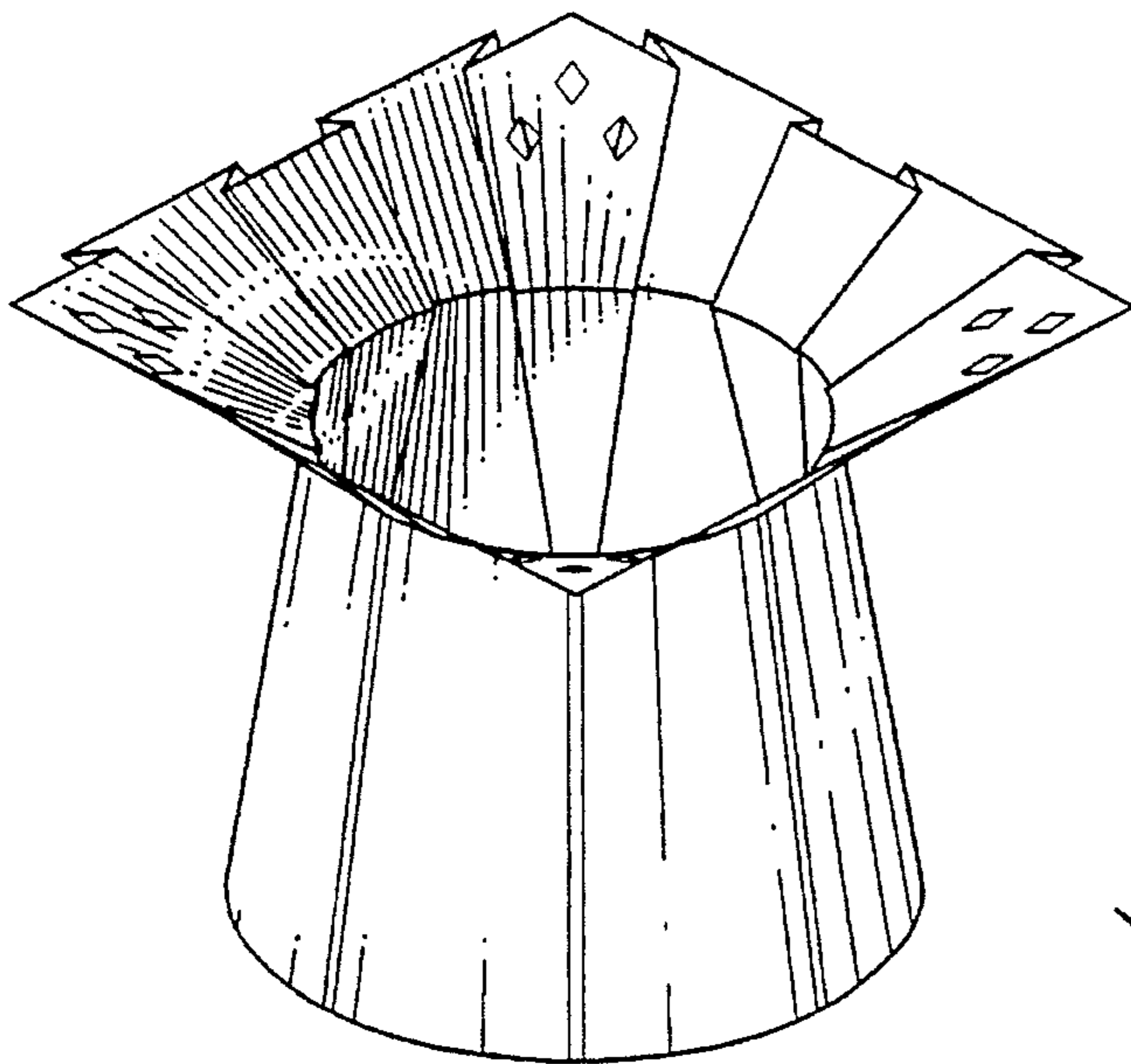

FIG. 31

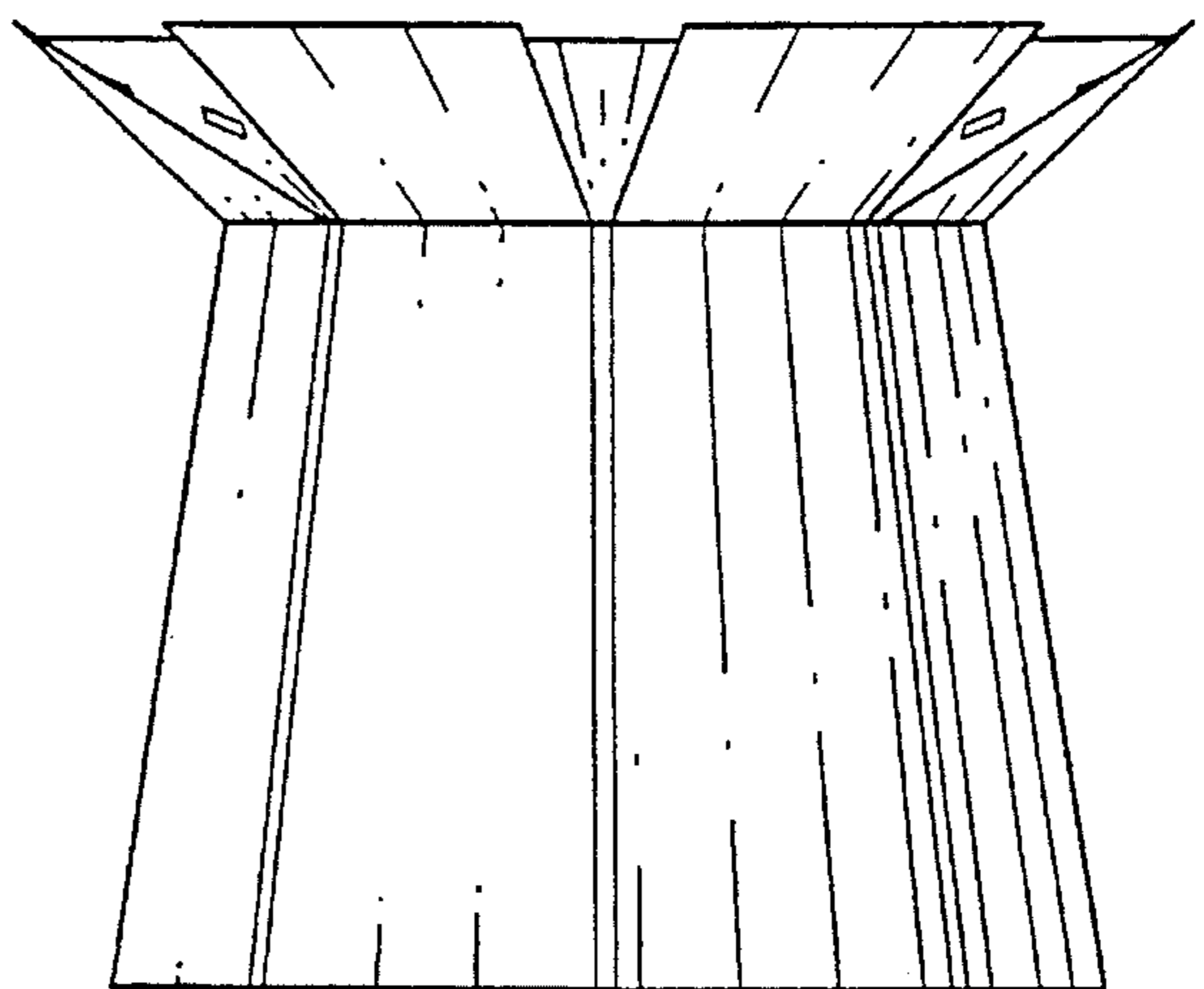

FIG. 32

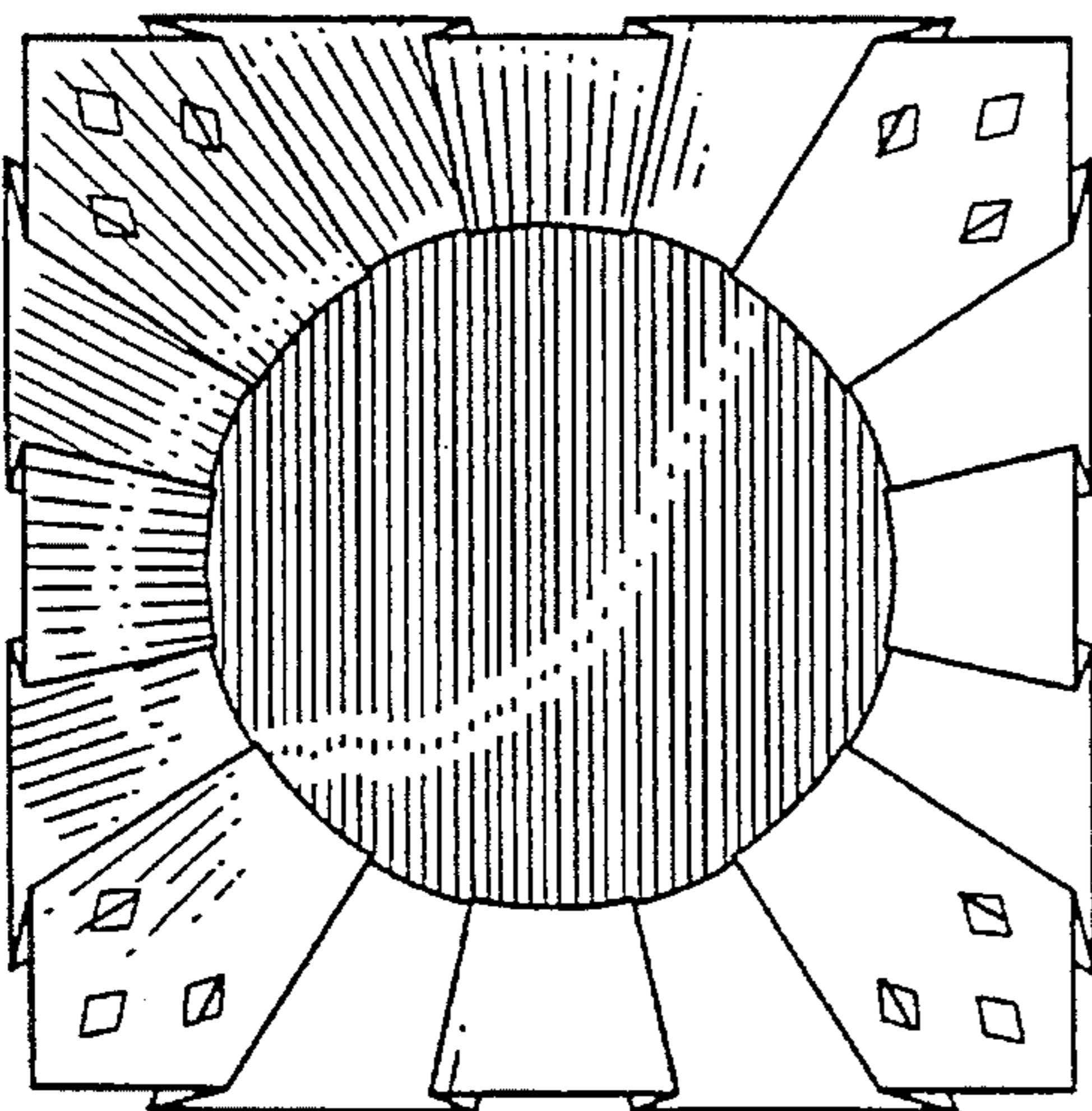

FIG. 33

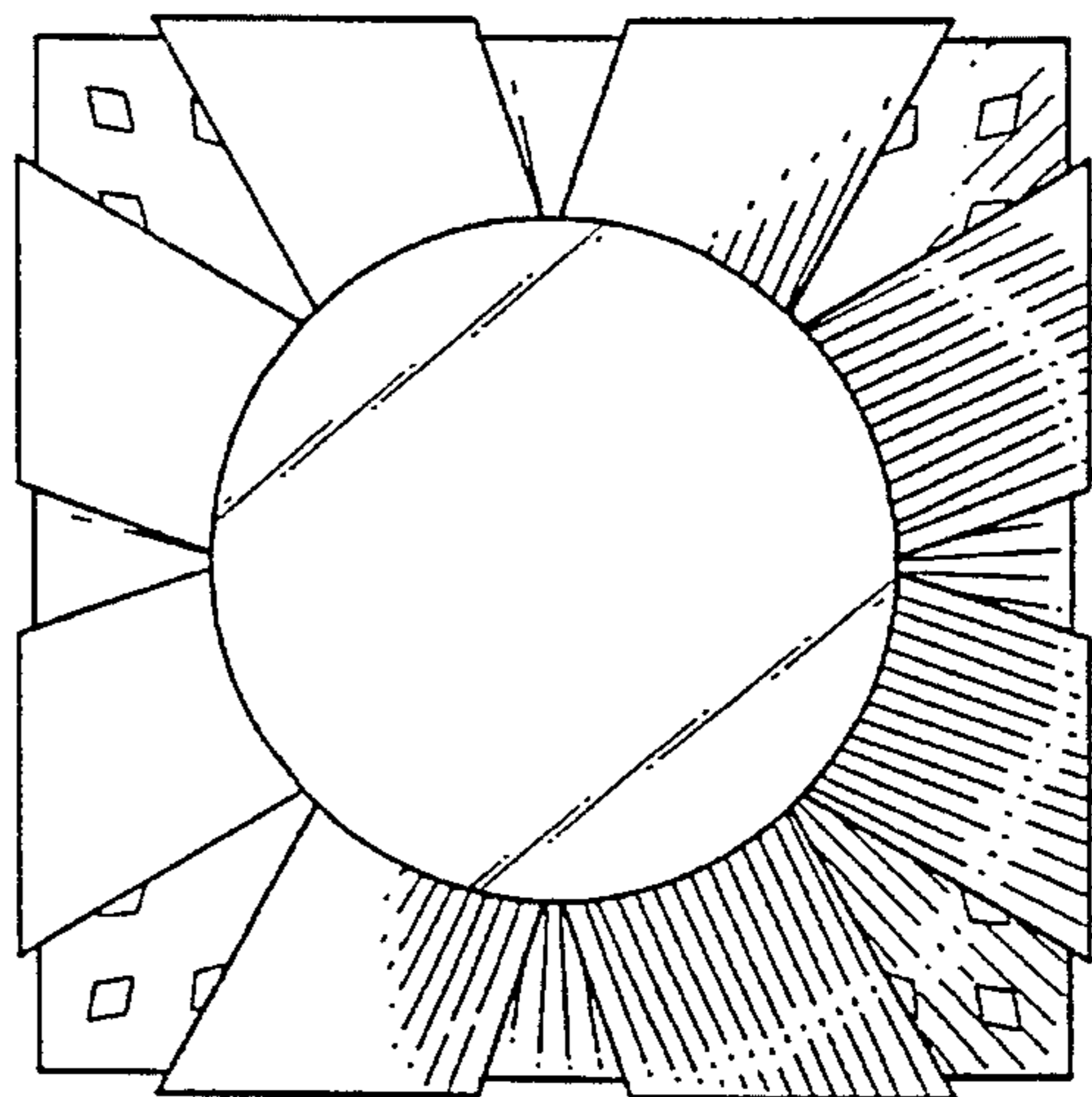

FIG. 34

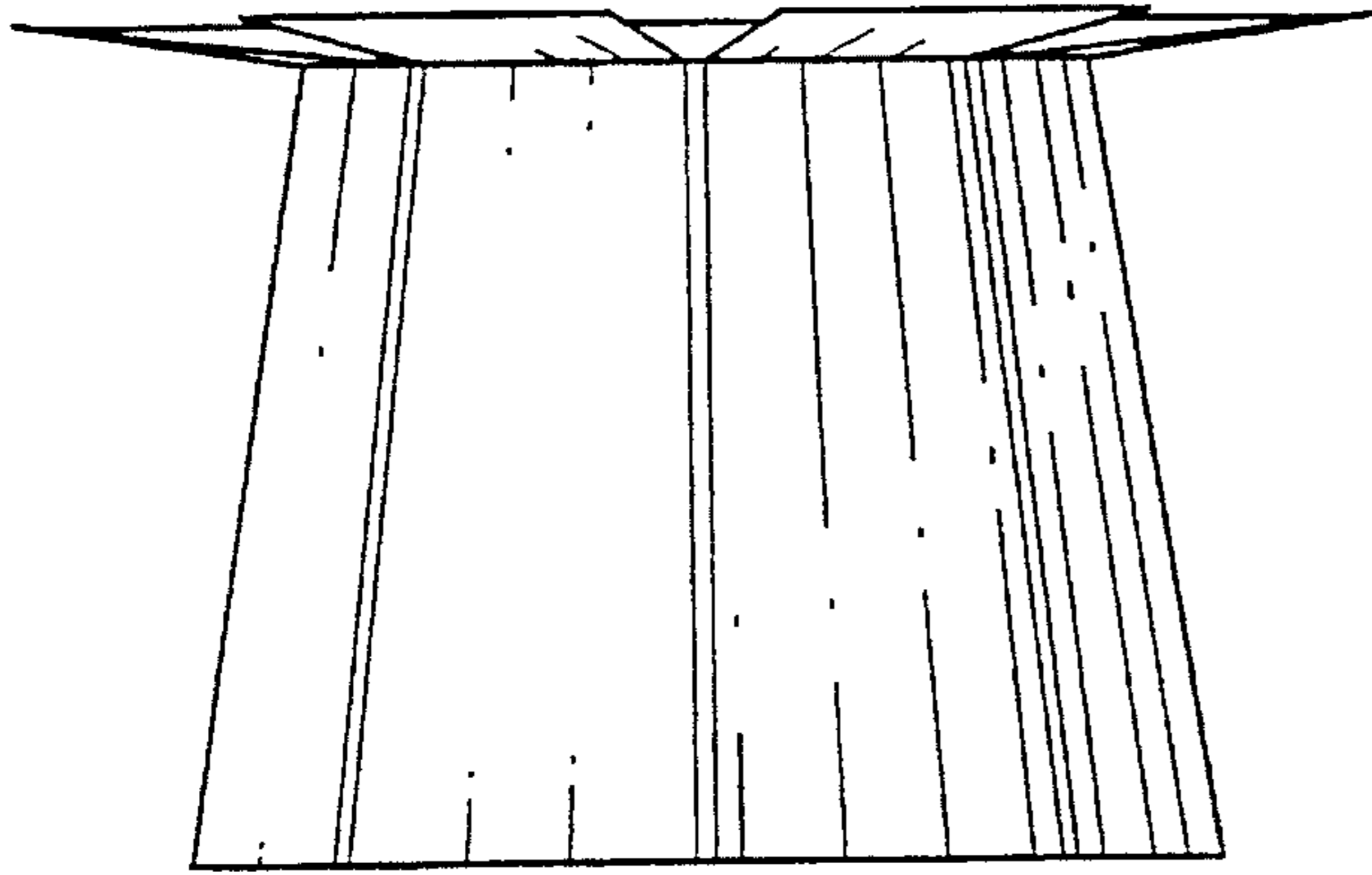

FIG. 35

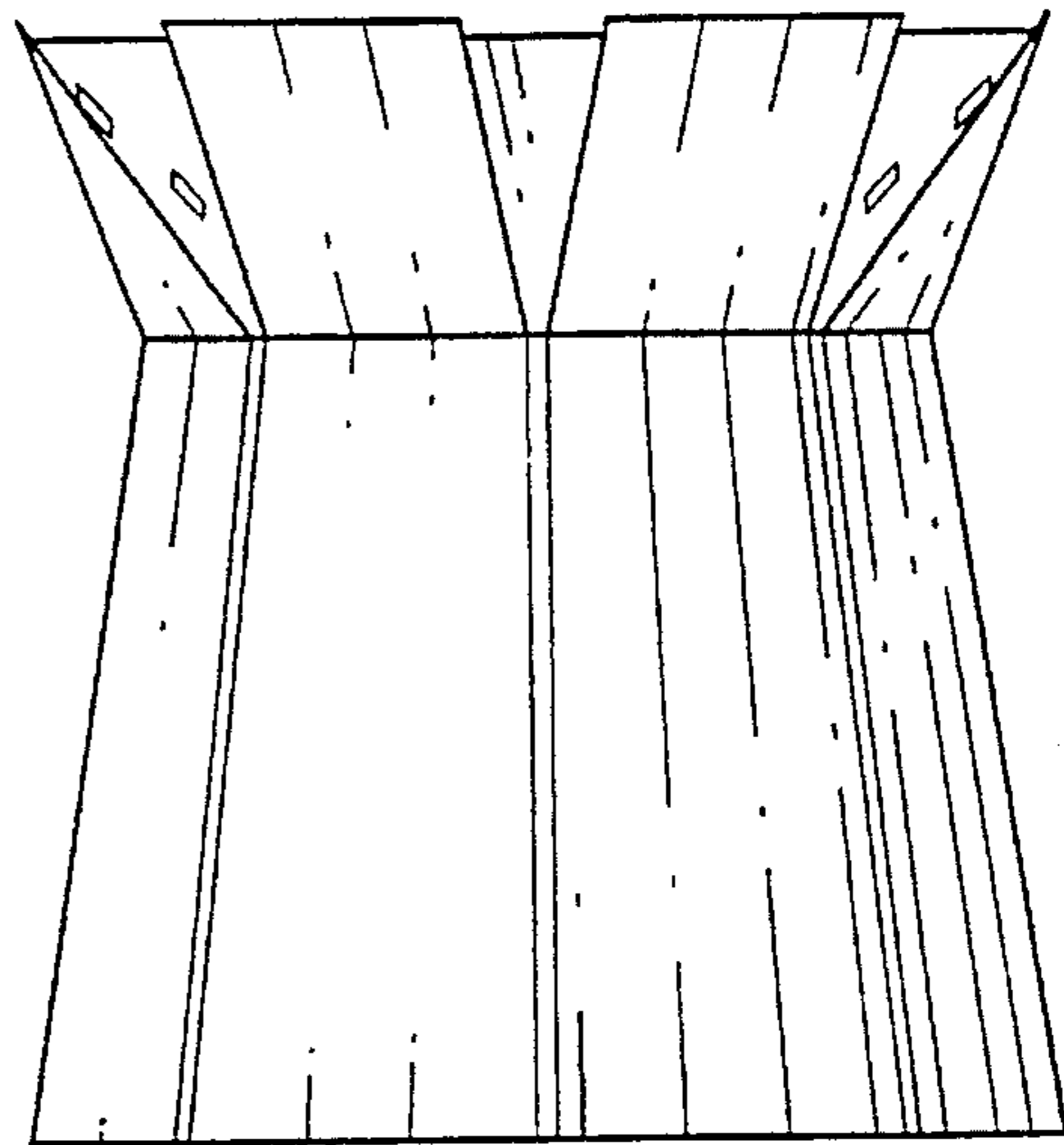

FIG. 36

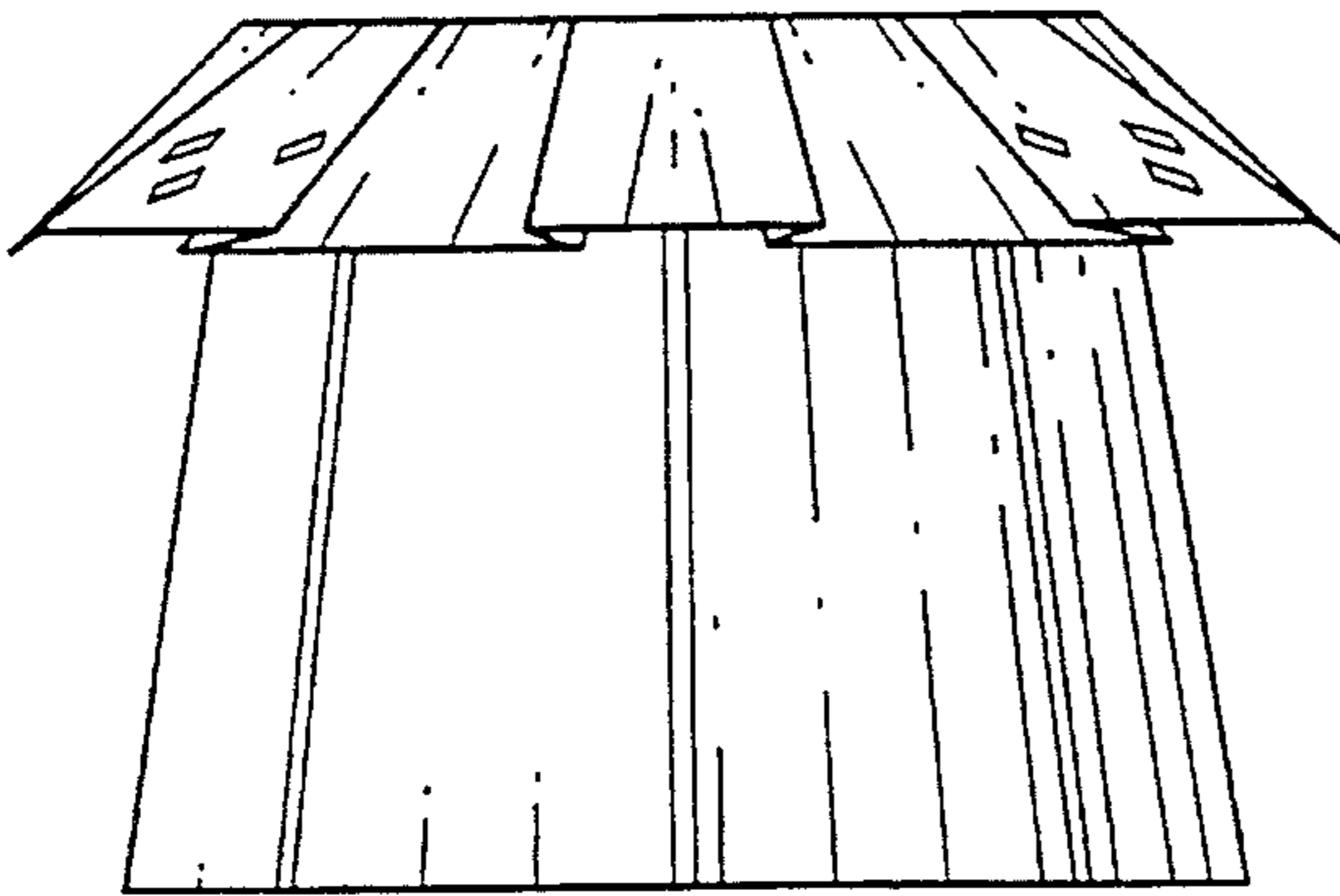

FIG. 37

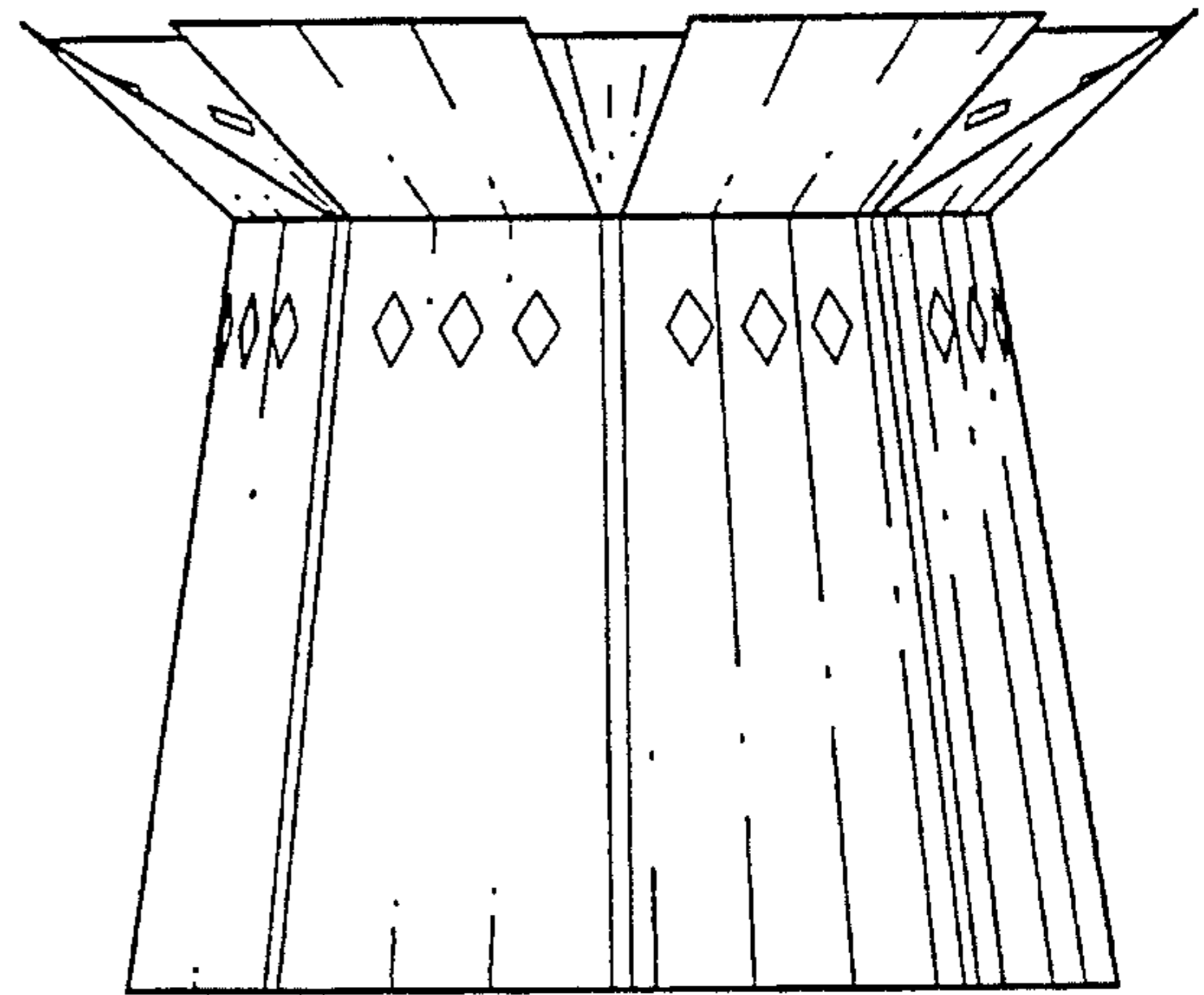

FIG. 38

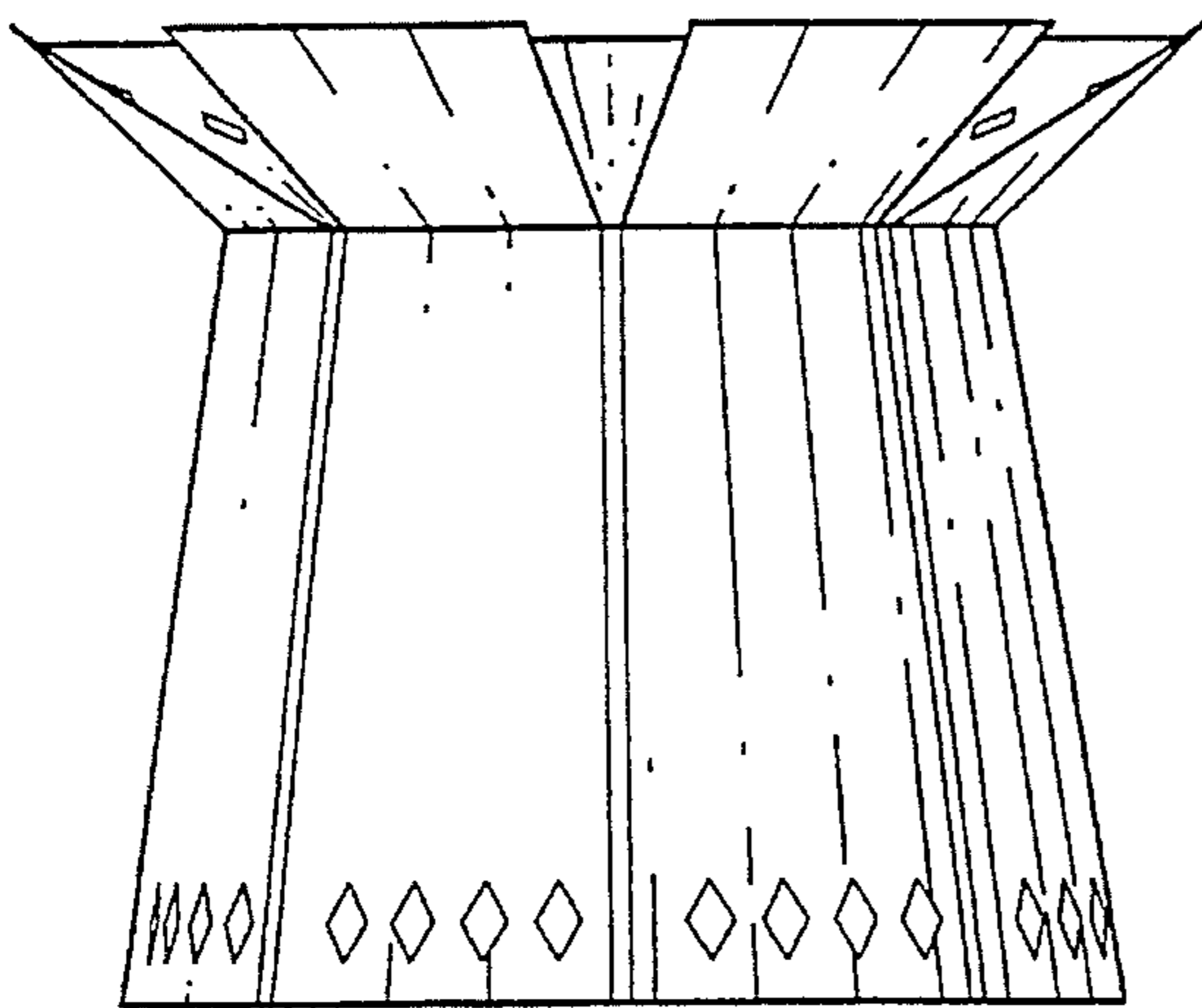

FIG. 39

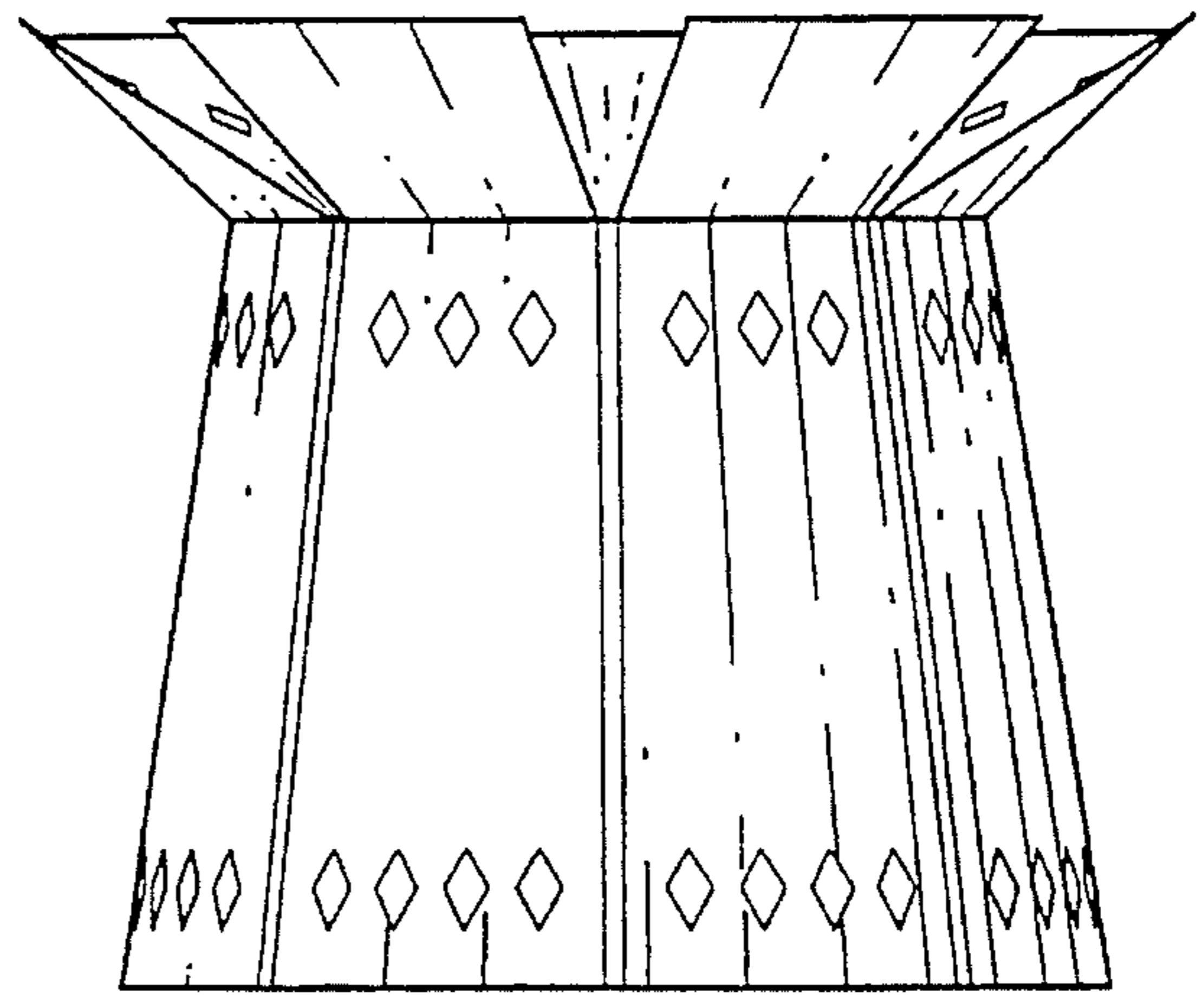

FIG. 40

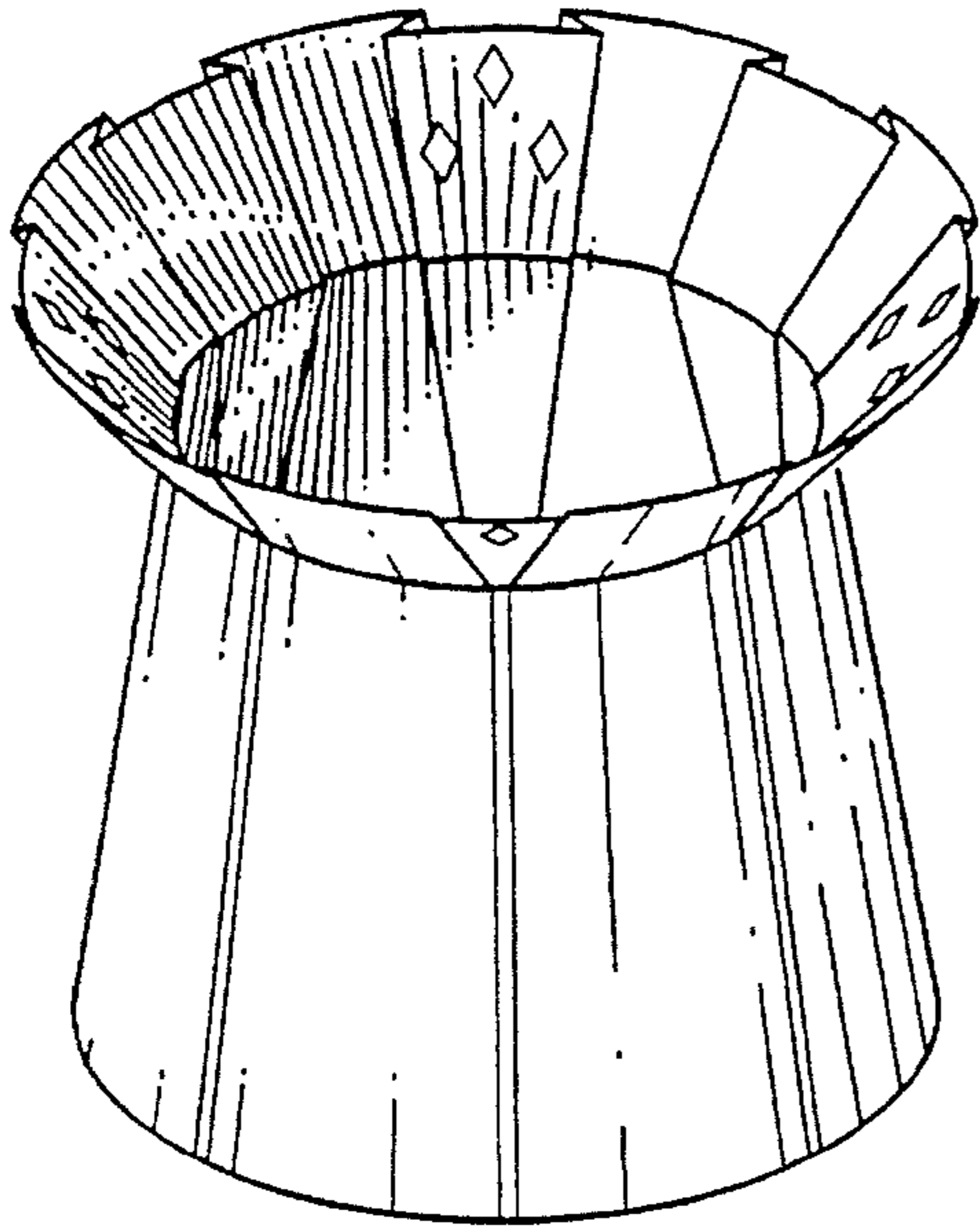

FIG. 41

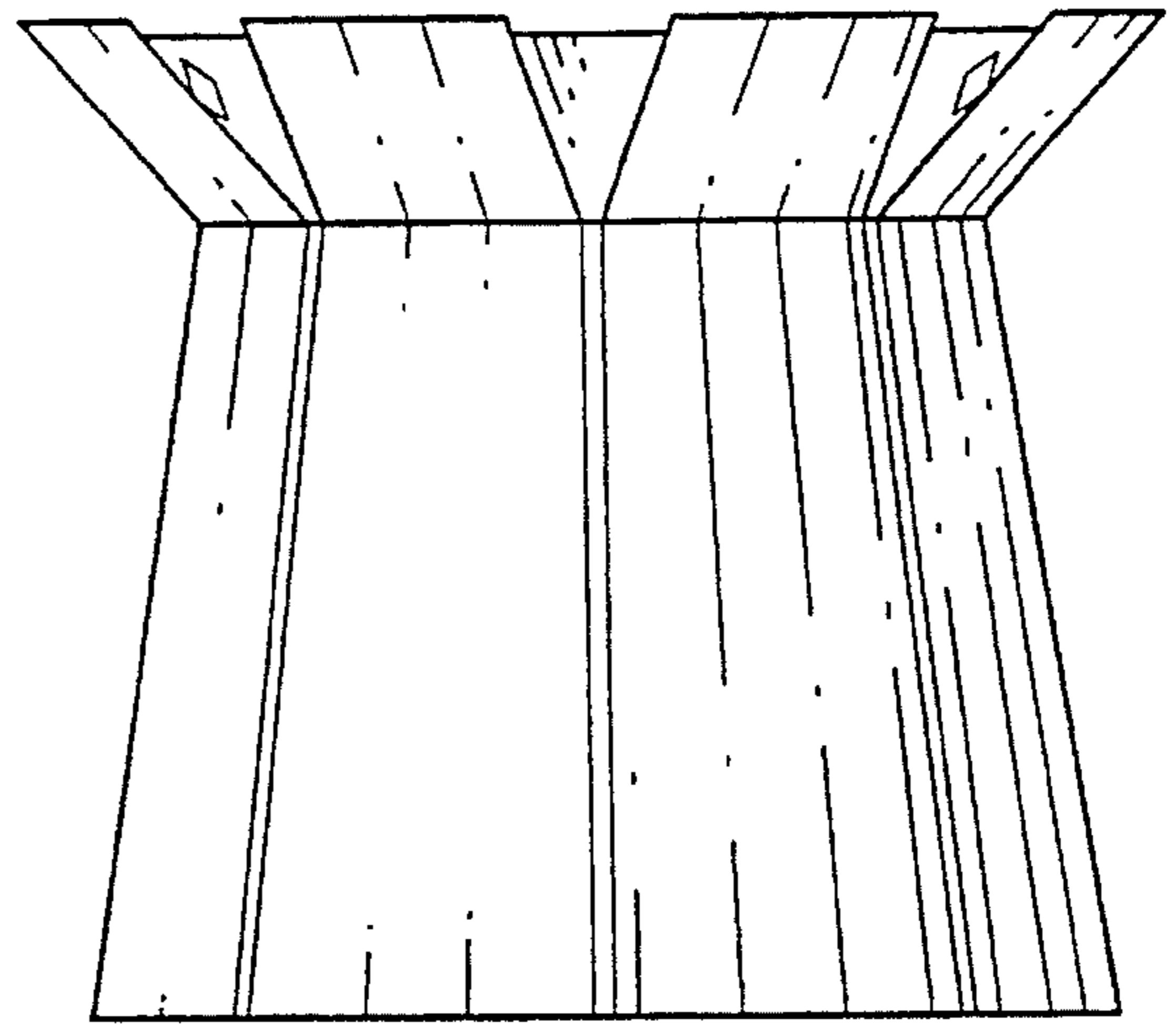

FIG. 42

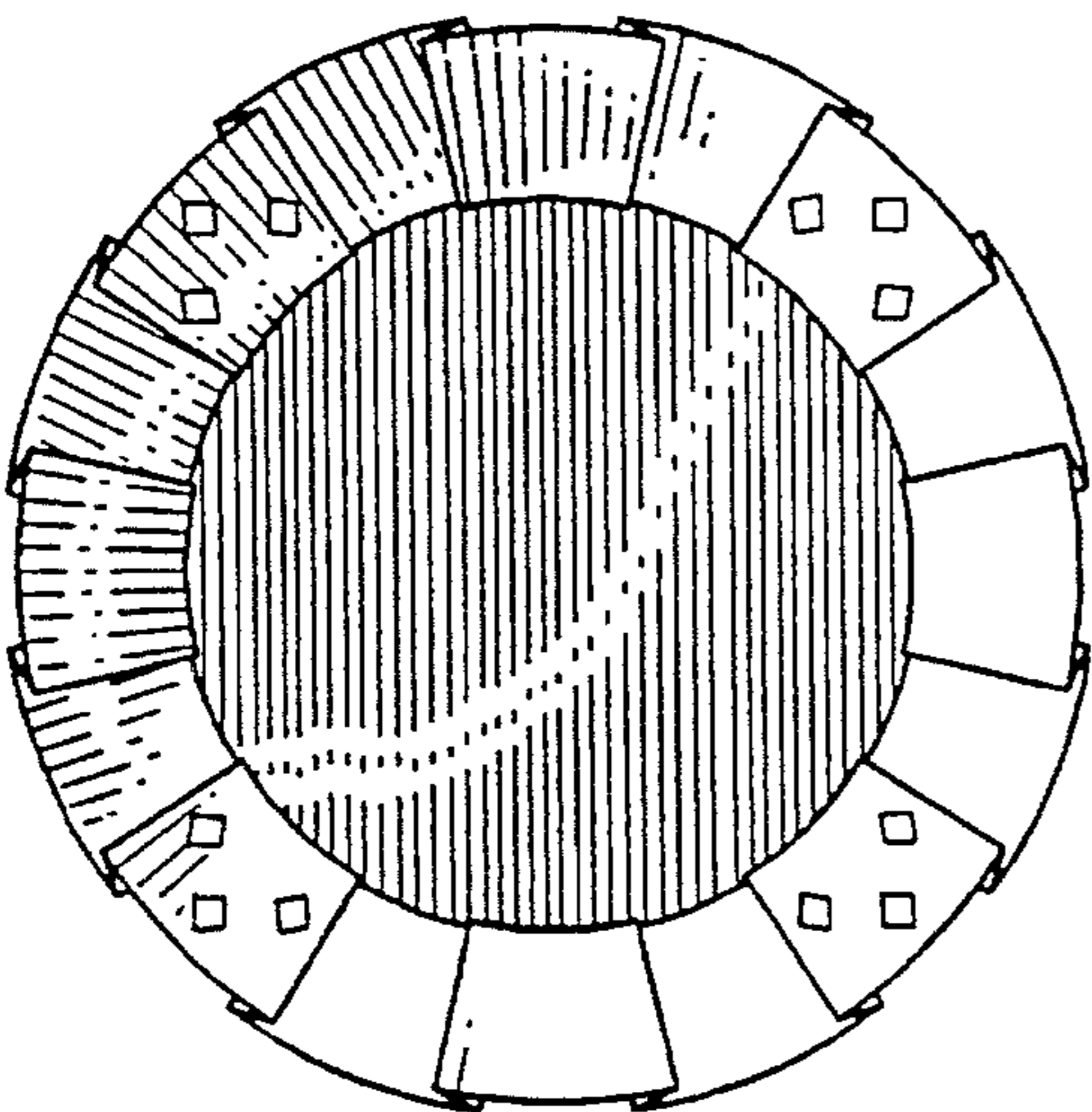

FIG. 43

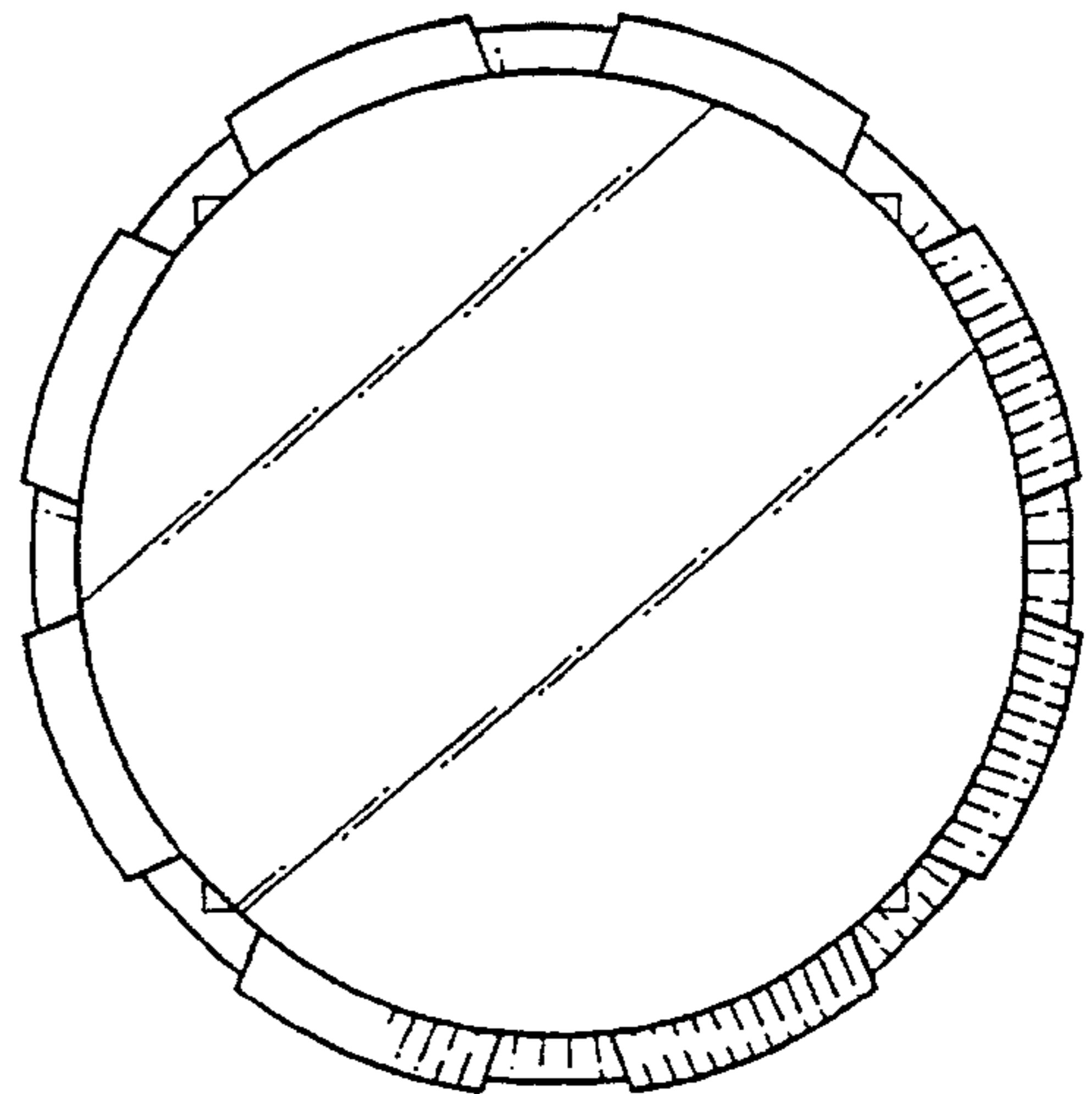

FIG. 44

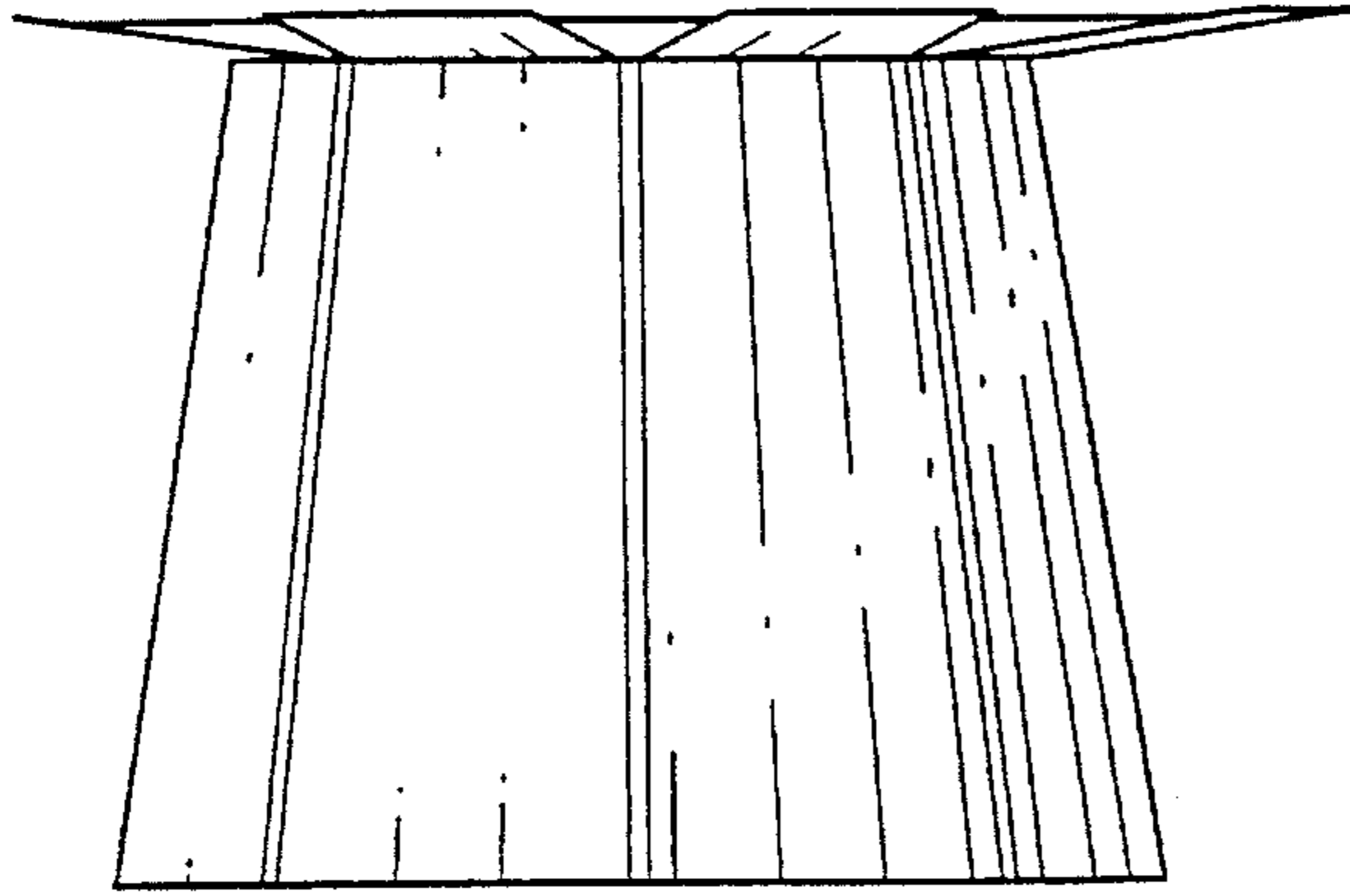

FIG. 45

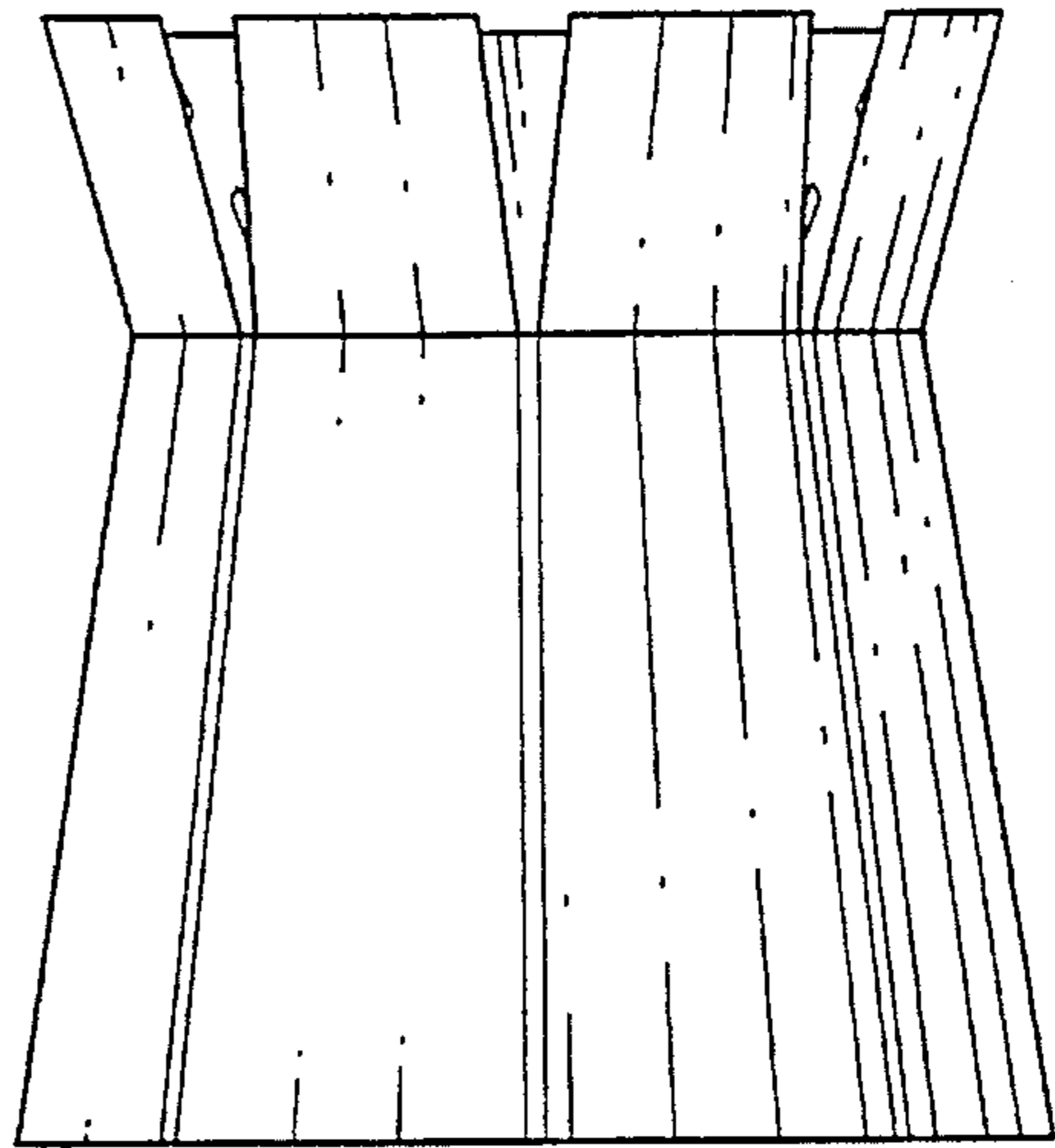

FIG. 46

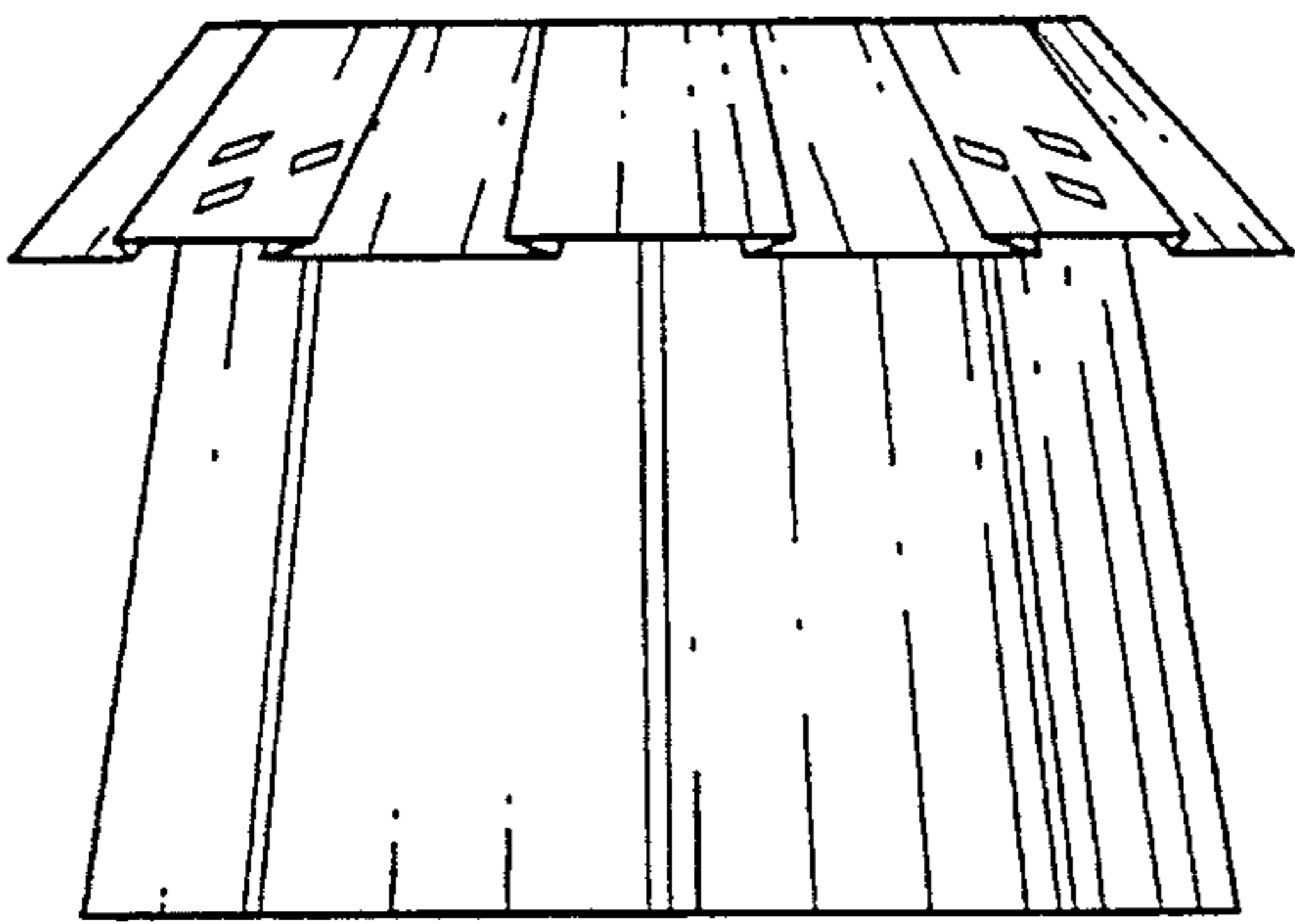

FIG. 47

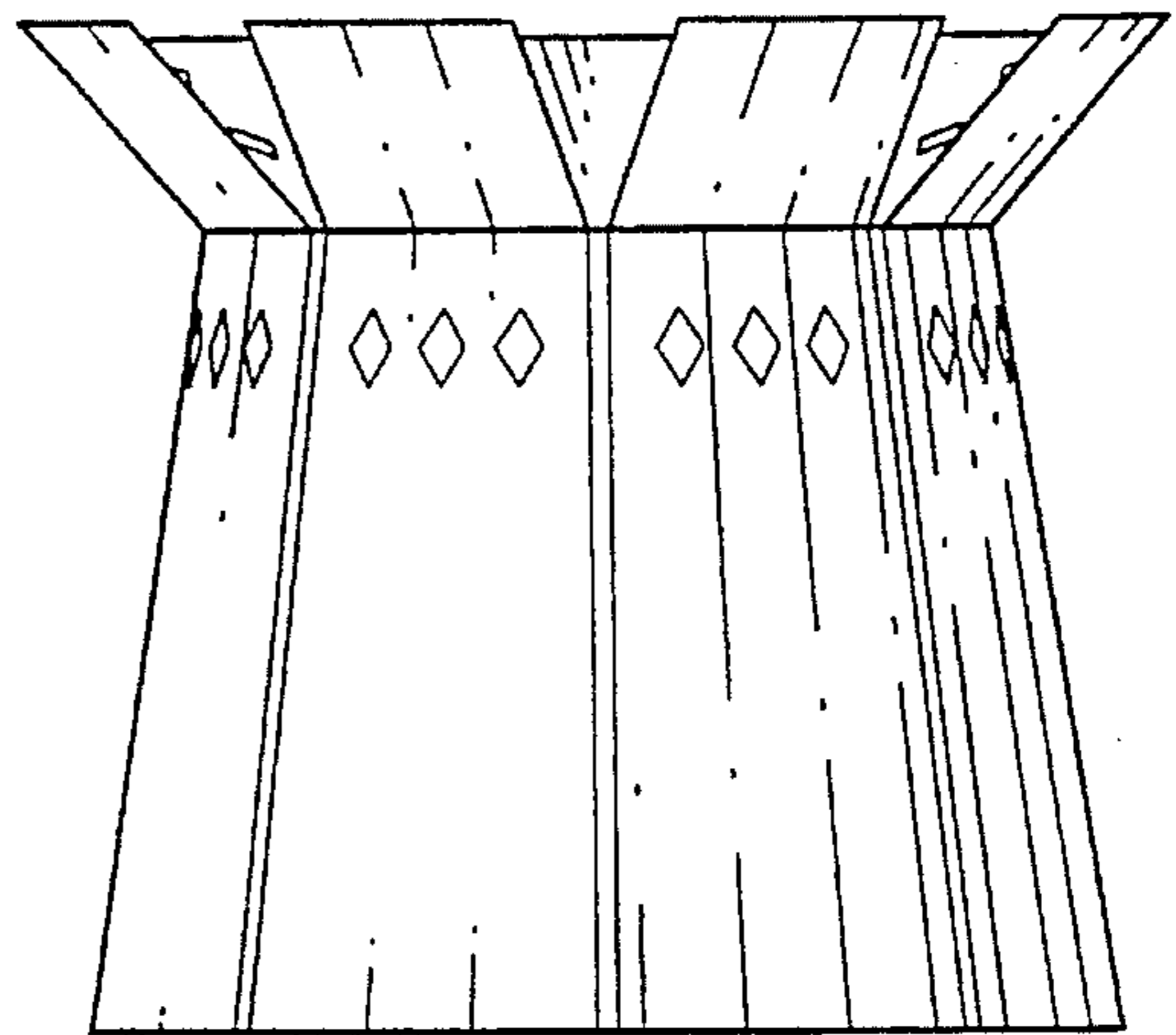

FIG. 48

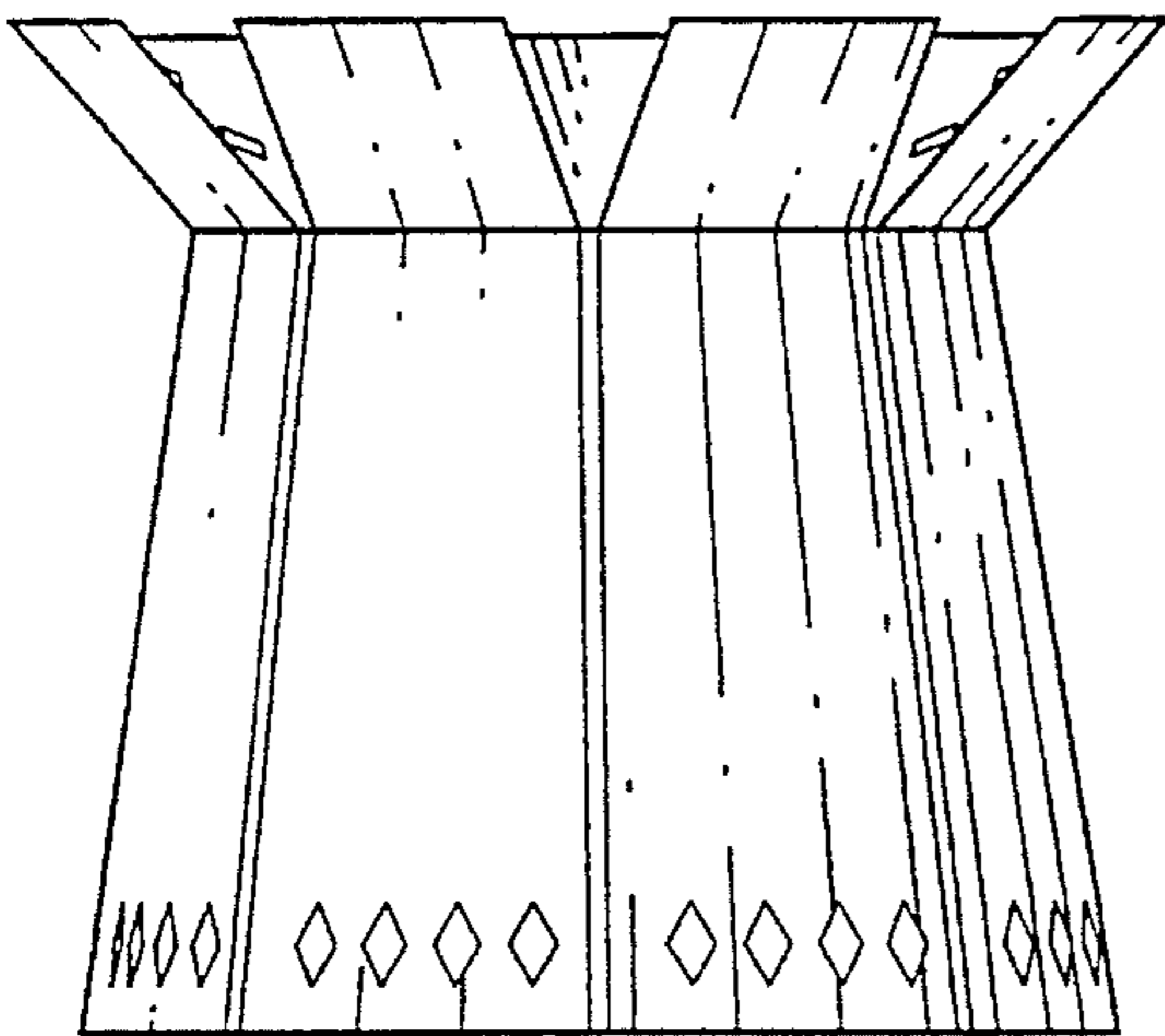

FIG. 49

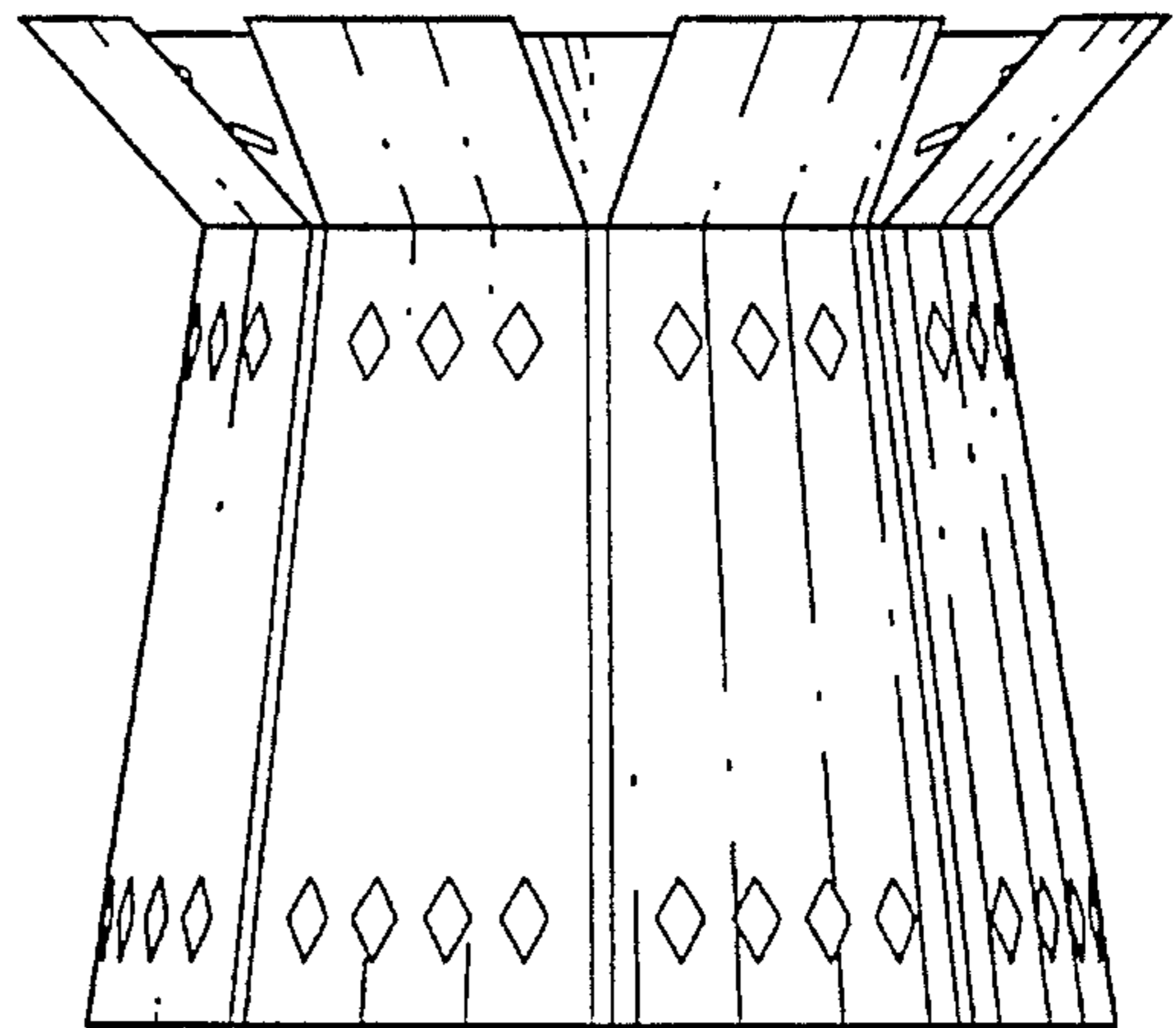

FIG. 50