



US00D370431S

United States Patent [19]

[11] Patent Number: Des. 370,431

Weder et al.

[45] Date of Patent: *** Jun. 4, 1996

[54] FLOWER POT COVER

[75] Inventors: Donald E. Weder; Joseph G. Straeter, both of Highland, Ill.

[73] Assignee: Highland Supply Corporation, Highland, Ill.

[*] Notice: The portion of the term of this patent subsequent to Apr. 30, 2010, has been disclaimed.

[**] Term: 14 Years

[21] Appl. No.: 671

[22] Filed: Oct. 20, 1992

Related U.S. Application Data

[63] Continuation-in-part of Ser. No. 781,453, Oct. 21, 1991, Pat. No. Des. 348,634, which is a continuation-in-part of Ser. No. 617,454, Nov. 21, 1990, abandoned, Ser. No. 411,249, Sep. 22, 1989, Pat. No. Des. 358,113, Ser. No. 411,247, Sep. 22, 1989, and Ser. No. 411,245, Sep. 22, 1989.

[52] U.S. Cl. D11/164; D11/155

[58] Field of Search D11/143, 149, D11/152-156, 164, 89, 90; 47/66, 72; 206/423; 215/100.5; 229/1.5 R, 1.5 B, 4.5, 87.01, 922, 930, 108, 108.1, 109, 110; 428/27, 35.1, 24, 542.6; D9/346, 428-431; D27/102, 133; D26/128-136; D19/96; D7/540, 584, 586, 587, 354

[56] References Cited

U.S. PATENT DOCUMENTS

D. 239,192	3/1976	Wiles et al.	D35/3 A
D. 254,659	4/1980	Karotseris	D11/143
D. 289,024	3/1987	Vaughn	D11/164
D. 292,182	10/1987	Weder et al.	D11/164
D. 293,224	12/1987	Weder et al.	D11/164
D. 293,774	1/1988	Weder et al.	D11/164
D. 315,878	4/1991	Weder et al.	D11/164
D. 315,879	4/1991	Weder et al.	D11/164
D. 318,030	7/1991	Weder et al.	D11/164
D. 318,635	7/1991	Weder et al.	D11/164
D. 322,403	12/1991	Eaton	D9/429
D. 324,659	3/1992	Stehouwer	D11/164

D. 336,041	6/1993	Zama	D9/429
D. 348,634	7/1994	Weder et al.	D11/164
1,924,926	8/1932	Gray	65/53
1,951,642	8/1932	Augustin et al.	47/34
3,253,768	3/1958	Gjesdal	D9/431 X
3,443,741	5/1969	Stockdale	D9/431 X
4,043,077	8/1977	Stonehocker	47/66
4,216,620	8/1980	Weder et al.	47/12
4,300,312	11/1981	Weder et al.	47/72
4,712,725	12/1987	Moore	229/8
4,733,521	3/1988	Weder et al.	53/580
5,076,011	12/1991	Stehouwer	47/72

FOREIGN PATENT DOCUMENTS

2489126	3/1982	France
2603159	4/1988	France

OTHER PUBLICATIONS

Exhibit A—Speed Cover® Brochure—The Simple Solution . . . , ©1989.

Exhibit A. "The Glass of Frederick Carder", copyright 1971 by P. V. Gardner, showing various styles of glass basket-like vases or containers.

Primary Examiner—Jeffrey Asch
Attorney, Agent, or Firm—Dunlap & Coddling

[57] CLAIM

The ornamental design for a flower pot cover, as shown and described.

DESCRIPTION

FIG. 1 is a perspective view of our new flower pot cover design;

FIG. 2 is a side elevational view thereof;

FIG. 3 is a top plan view thereof;

FIG. 4 is a bottom plan view thereof;

FIG. 5 is a side elevational view of the design of FIG. 1, the only difference being in the horizontal angle of the skirt;

FIG. 6 is a side elevational view of the design of FIG. 1, the only difference being in the near vertical angle of the skirt;

FIG. 7 is a side elevational view of the design of FIG. 1, the only difference being in the downward angle of the skirt;

FIG. 8 is a side elevational view of a second embodiment of the design of FIG. 1, the only difference being in the height of the base;

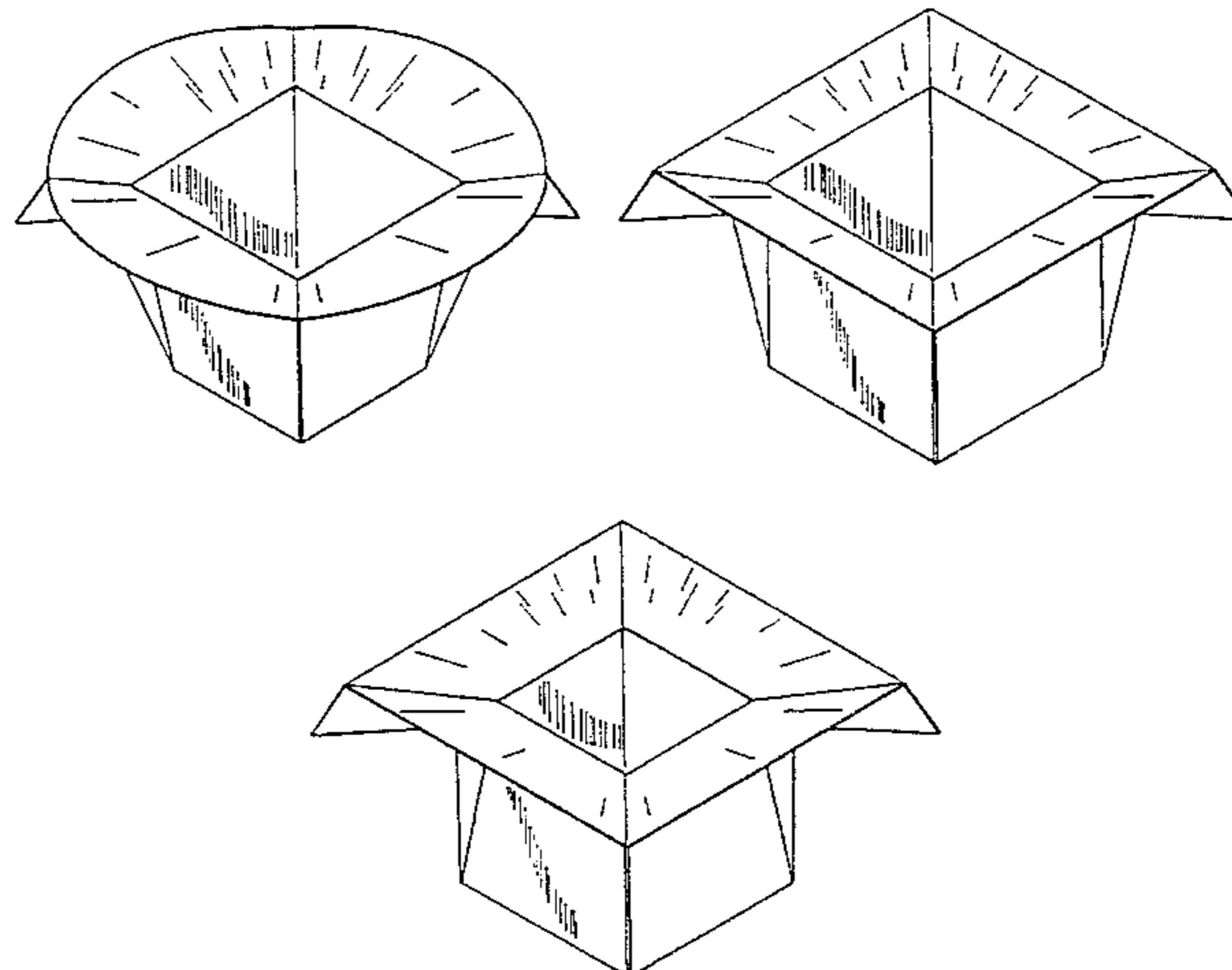

FIG. 9 is a side elevational view of a third embodiment of the design of FIG. 1, the only difference being in the height of the base;

FIG. 10 is a top plan view of a fourth embodiment of the design of FIG. 1, the only difference being in the size of the skirt;

FIG. 11 is a top plan view of a fifth embodiment of the design of FIG. 1, the only difference being in the size of the skirt;

FIG. 12 is a perspective view of a sixth embodiment of our new flower pot cover design;

FIG. 13 is a side elevational view thereof;

FIG. 14 is a top plan view thereof;

FIG. 15 is a bottom plan view thereof;

FIG. 16 is a side elevational view of the design of FIG. 12, the only difference being in the horizontal angle of the skirt;

FIG. 17 is a side elevational view of the design of FIG. 12, the only difference being in the near vertical angle of the skirt;

FIG. 18 is a side elevational view of the design of FIG. 12, the only difference being in the downward angle of the skirt;

FIG. 19 is a side elevational view of a seventh embodiment of the flower pot cover design of FIG. 12, the only difference being in the height of the base;

FIG. 20 is a side elevational view of an eighth embodiment of the new flower pot cover design of FIG. 12, the only difference being in the height of the base;

FIG. 21 is a top plan view of a ninth embodiment of the flower pot cover design of FIG. 12, the only difference being in the size of the skirt;

FIG. 22 is a top plan view of a tenth embodiment of the flower pot cover design of FIG. 12, the only difference being in the size of the skirt;

FIG. 23 is a perspective view of an eleventh embodiment of our new flower pot cover design;

FIG. 24 is a side elevational view thereof;

FIG. 25 is a top plan view thereof;

FIG. 26 is a bottom plan view thereof;

FIG. 27 is a side elevational view of the design of FIG. 23, the only difference being in the horizontal angle of the skirt;

FIG. 28 is a side elevational view of the design of FIG. 23, the only difference being in the near vertical angle of the skirt;

FIG. 29 is a side elevational view of the design of FIG. 23, the only difference being in the downward angle of the skirt;

FIG. 30 is a side elevational view of a twelfth embodiment of the flower pot cover design of FIG. 23, the only difference being in the height of the base;

FIG. 31 is a side elevational view of a thirteenth embodiment of the new flower pot cover design of FIG. 23, the only difference being in the height of the base;

FIG. 32 is a top plan view of a fourteenth embodiment of the flower pot cover design of FIG. 23, the only difference being in the size of the skirt;

FIG. 33 is a top plan view of a fifteenth embodiment of the flower pot cover design of FIG. 23, the only difference being in the size of the skirt;

FIG. 34 is a perspective view of a sixteenth embodiment of our new flower pot cover design;

FIG. 35 is a side elevational view thereof;

FIG. 36 is a top plan view thereof;

FIG. 37 is a bottom plan view thereof;

FIG. 38 is a side elevational view of the design of FIG. 34, the only difference being in the horizontal angle of the skirt;

FIG. 39 is a side elevational view of the design of FIG. 34, the only difference being in the near vertical angle of the skirt;

FIG. 40 is a side elevational view of the design of FIG. 34, the only difference being in the downward angle of the skirt;

FIG. 41 is a side elevational view of a seventeenth embodiment of the flower pot cover design of FIG. 34, the only difference being in the height of the base;

FIG. 42 is a side elevational view of an eighteenth embodiment of the new flower pot cover design of FIG. 34, the only difference being in the height of the base;

FIG. 43 is a top plan view of a nineteenth embodiment of the flower pot cover design of FIG. 34, the only difference being in the size of the skirt;

FIG. 44 is a top plan view of a twentieth embodiment of the flower pot cover design of FIG. 34, the only difference being in the size of the skirt;

FIG. 45 is a perspective view of a twenty-first embodiment of our new flower pot cover design;

FIG. 46 is a side elevational view thereof;

FIG. 47 is a top plan view thereof;

FIG. 48 is a bottom plan view thereof;

FIG. 49 is a side elevational view of the design of FIG. 45, the only difference being in the horizontal angle of the skirt;

FIG. 50 is a side elevational view of the design of FIG. 45, the only difference being in the near vertical angle of the skirt;

FIG. 51 is a side elevational view of the design of FIG. 45, the only difference being in the downward angle of the skirt;

FIG. 52 is a side elevational view of a twenty-second embodiment of the flower pot cover design of FIG. 45, the only difference being in the height of the base;

FIG. 53 is a side elevational view of a twenty-third embodiment of the new flower pot cover design of FIG. 45 the only difference being in the height of the base;

FIG. 54 is a top plan view of a twenty-fourth embodiment of the flower pot cover design of FIG. 45, the only difference being in the size of the skirt;

FIG. 55 is a top plan view of a twenty-fifth embodiment of the flower pot cover design of FIG. 45, the only difference being in the size of the skirt;

FIG. 56 is a perspective view of a twenty-sixth embodiment of our new flower pot cover design;

FIG. 57 is a side elevational view thereof;

FIG. 58 is a top plan view thereof;

FIG. 59 is a bottom plan view thereof;

FIG. 60 is a side elevational view of the design of FIG. 56, the only difference being in the horizontal angle of the skirt;

FIG. 61 is a side elevational view of the design of FIG. 56, the only difference being in the near vertical angle of the skirt;

FIG. 62 is a side elevational view of the design of FIG. 56, the only difference being in the downward angle of the skirt;

FIG. 63 is a side elevational view of a twenty-seventh embodiment of the flower pot cover design of FIG. 56, the only difference being in the height of the base;

FIG. 64 is a side elevational view of a twenty-eighth embodiment of the new flower pot cover design of FIG. 56, the only difference being in the height of the base;

FIG. 65 is a top plan view of a twenty-ninth embodiment of the flower pot cover design of FIG. 56, the only difference being in the size of the skirt; and,

FIG. 66 is a top plan view of a thirtieth embodiment of the flower pot cover design of FIG. 56, the only difference being in the size of the skirt.

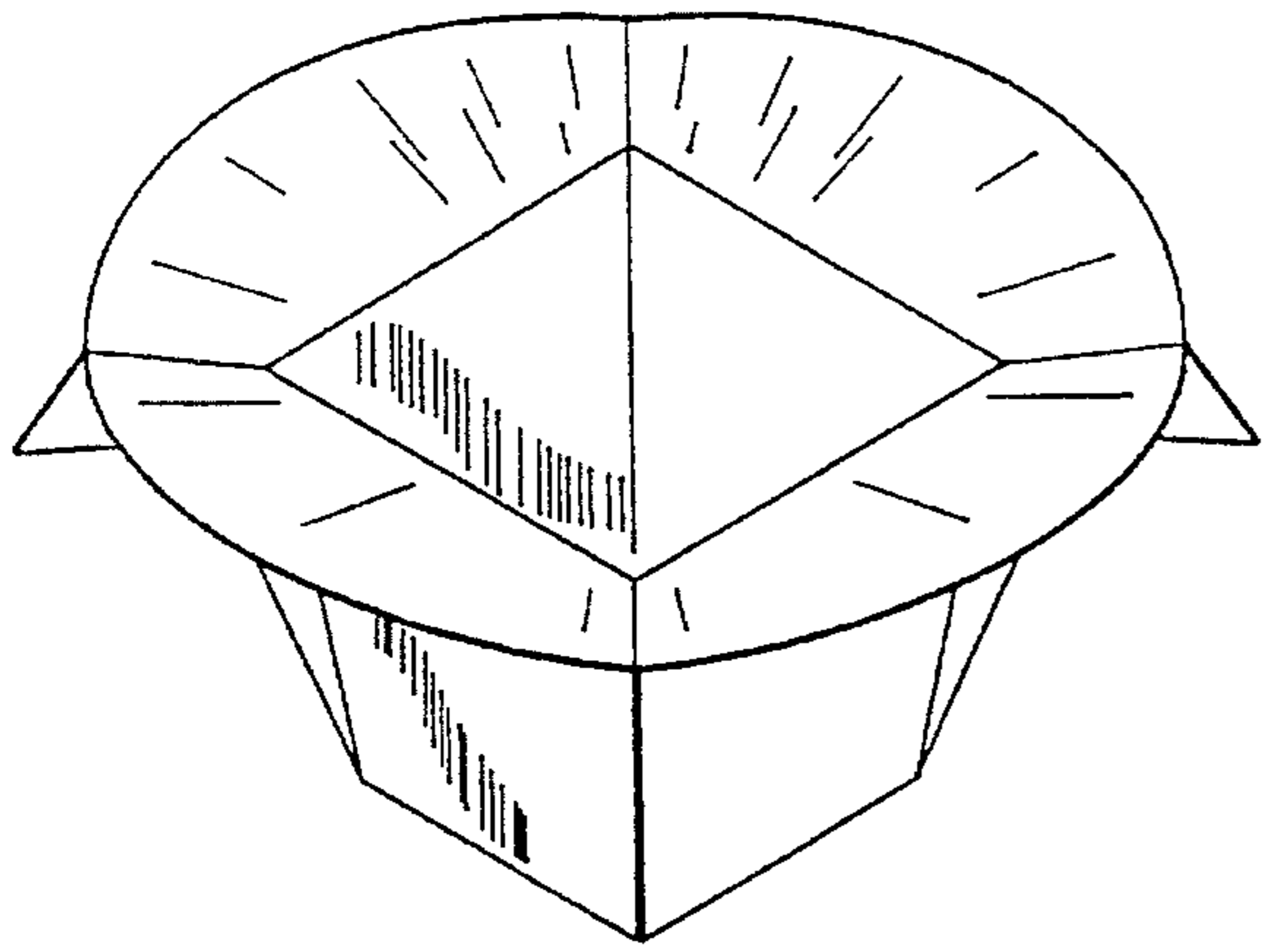

FIG. 1

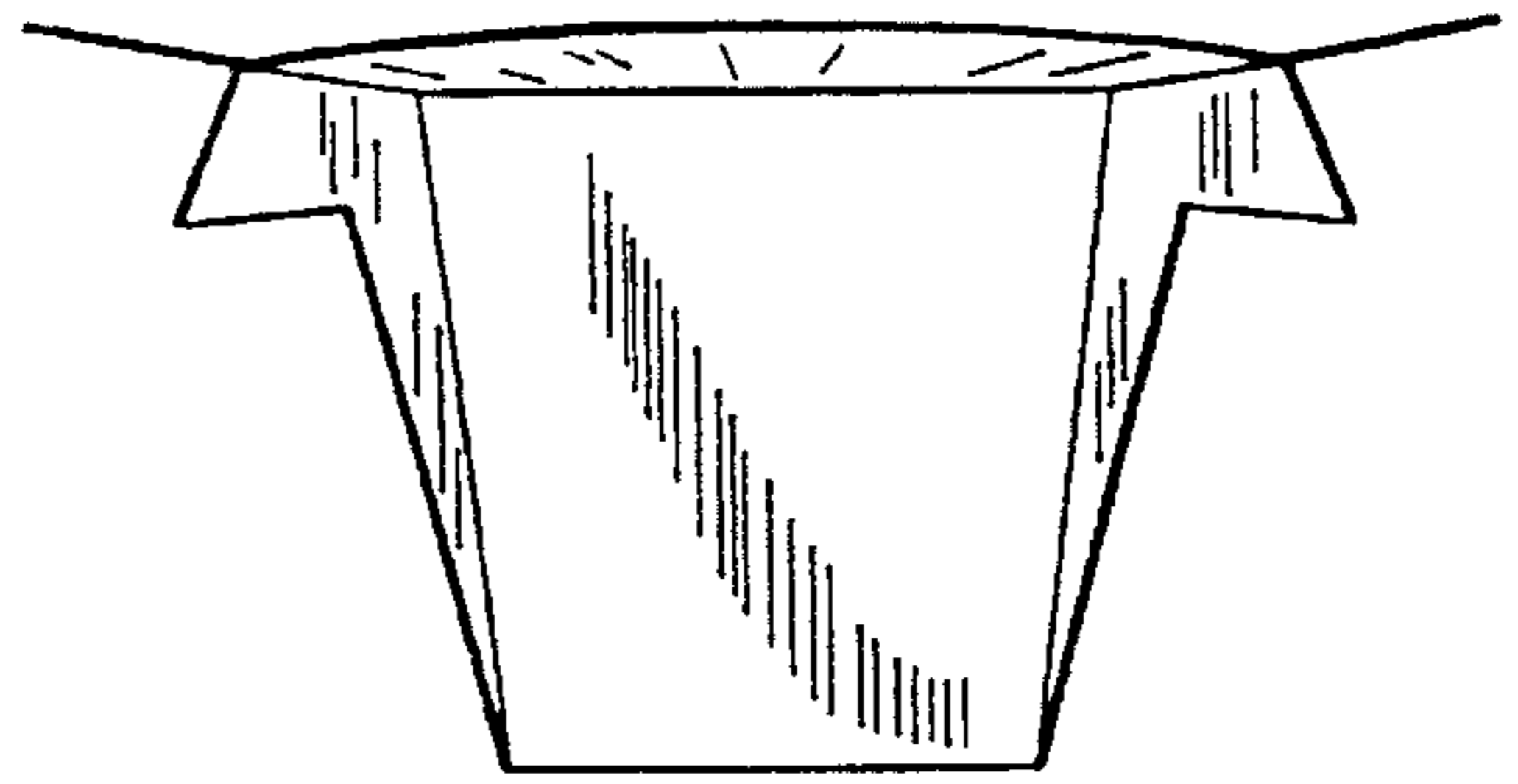

FIG. 2

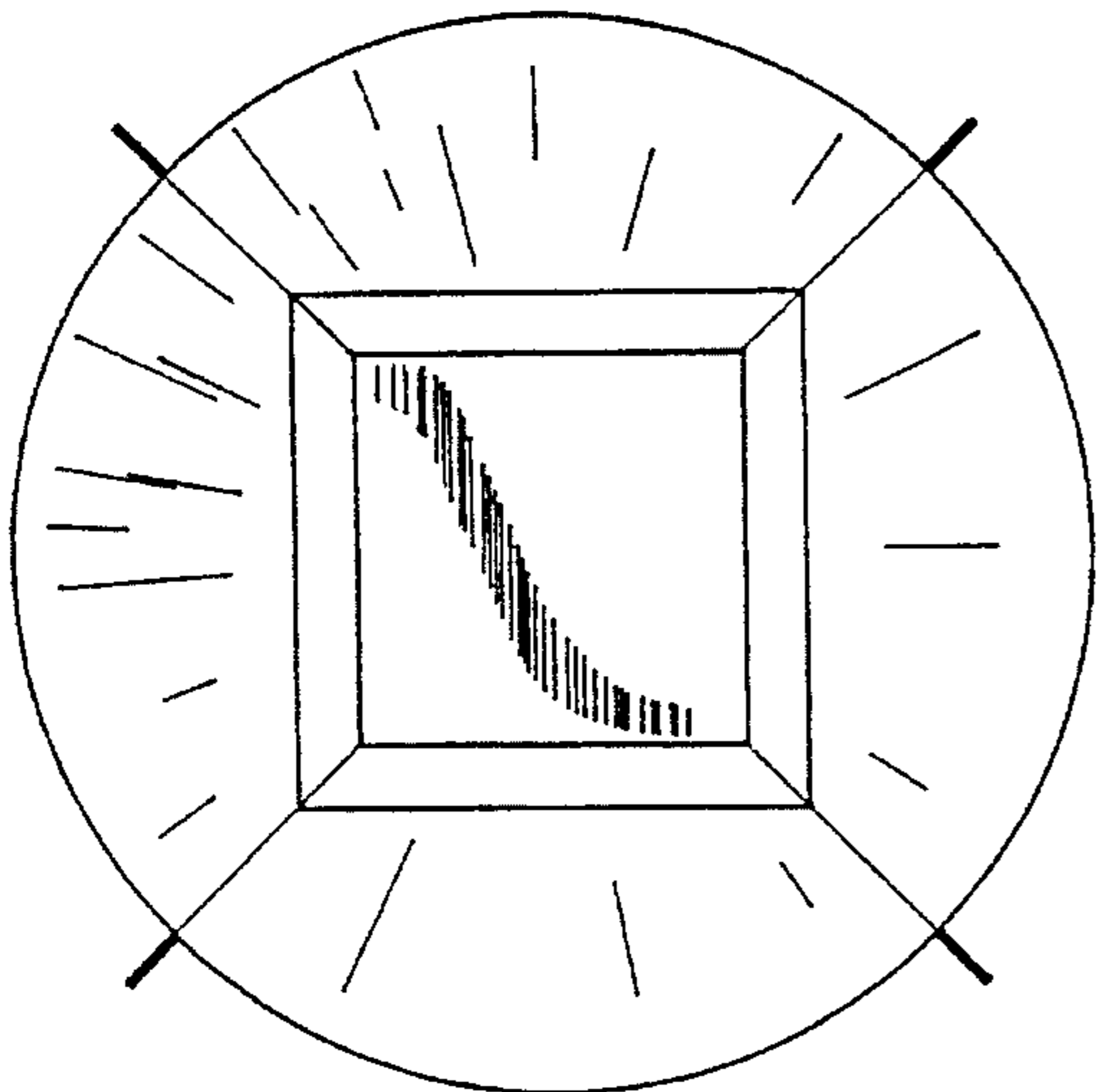

FIG. 3

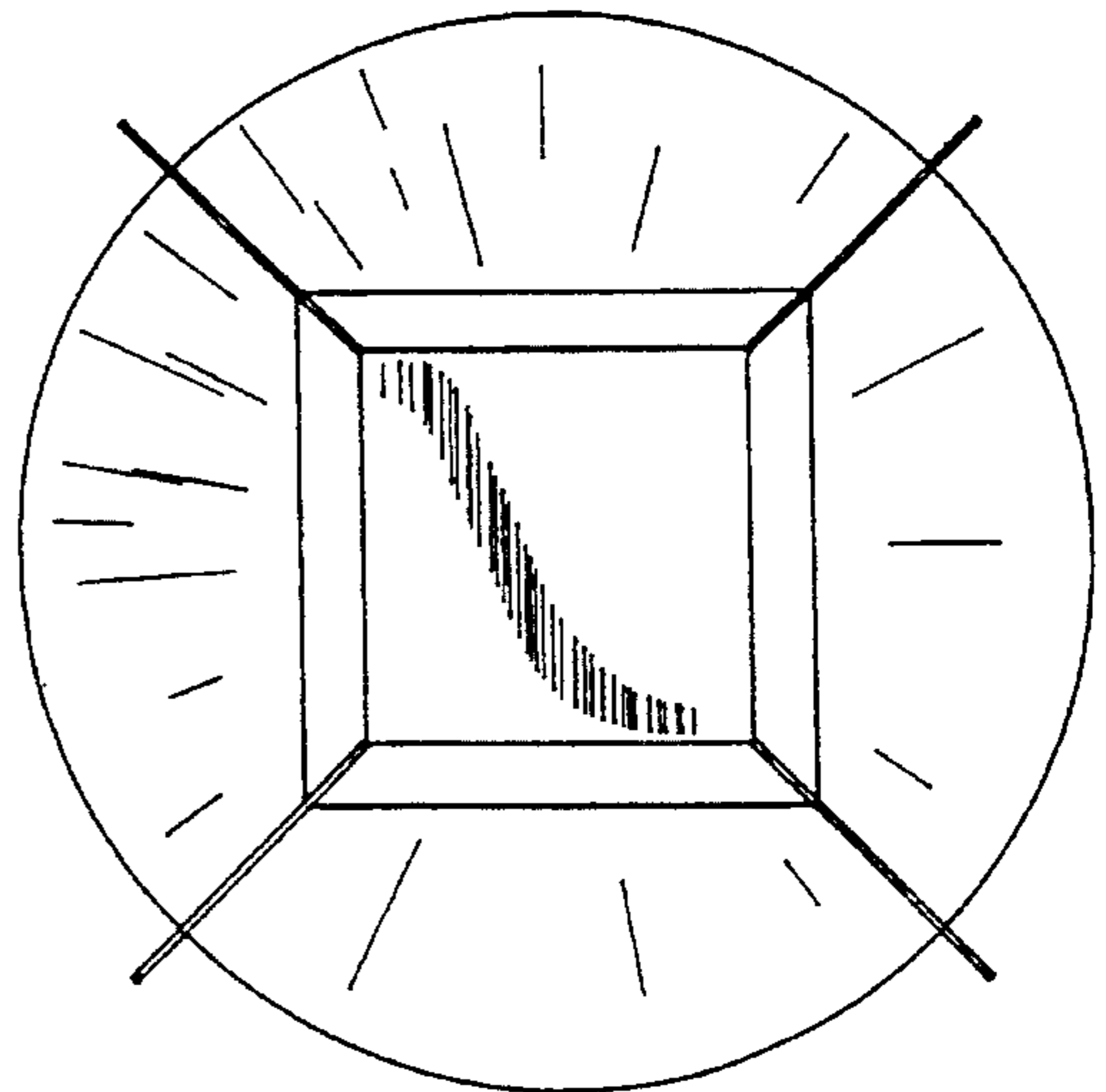

FIG. 4

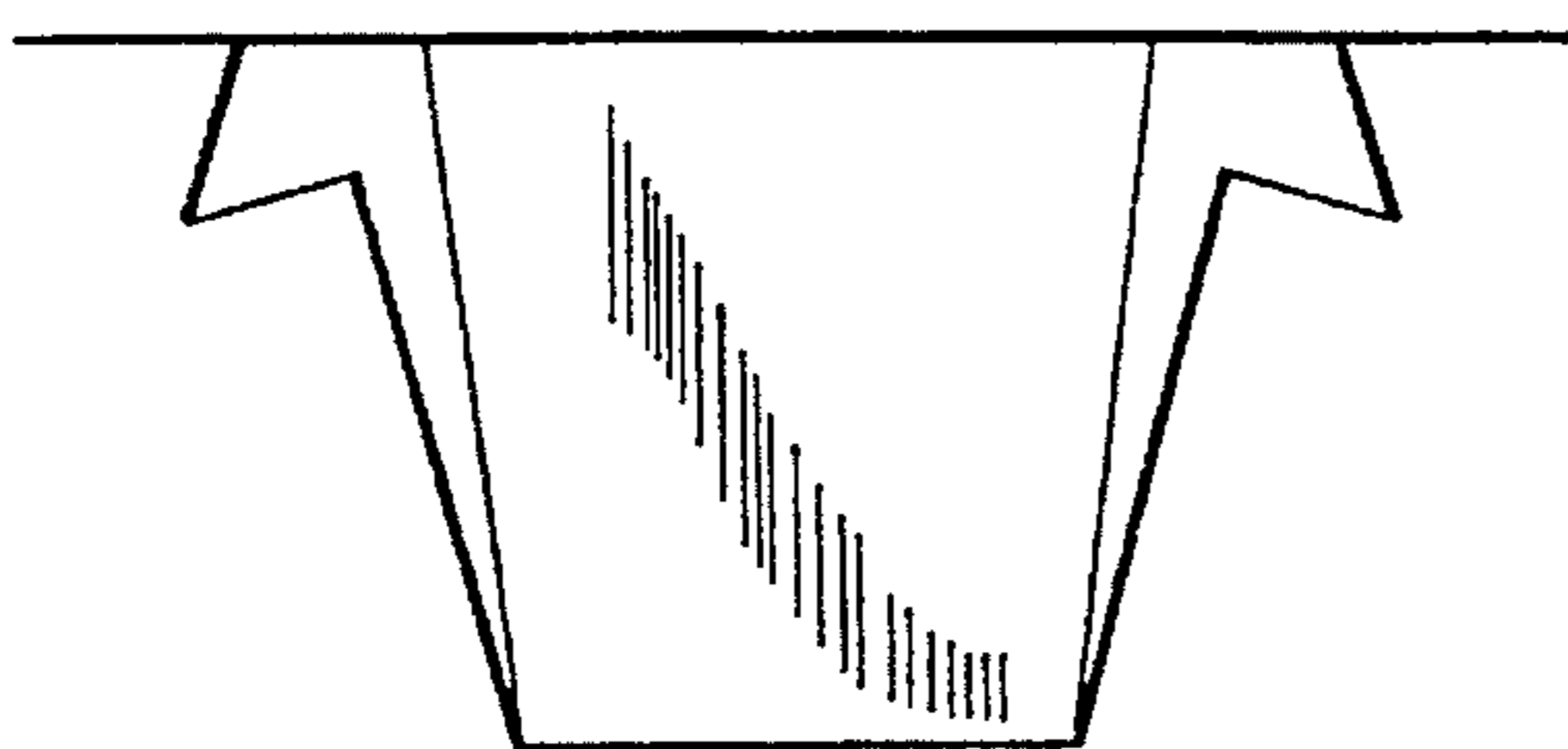

FIG. 5

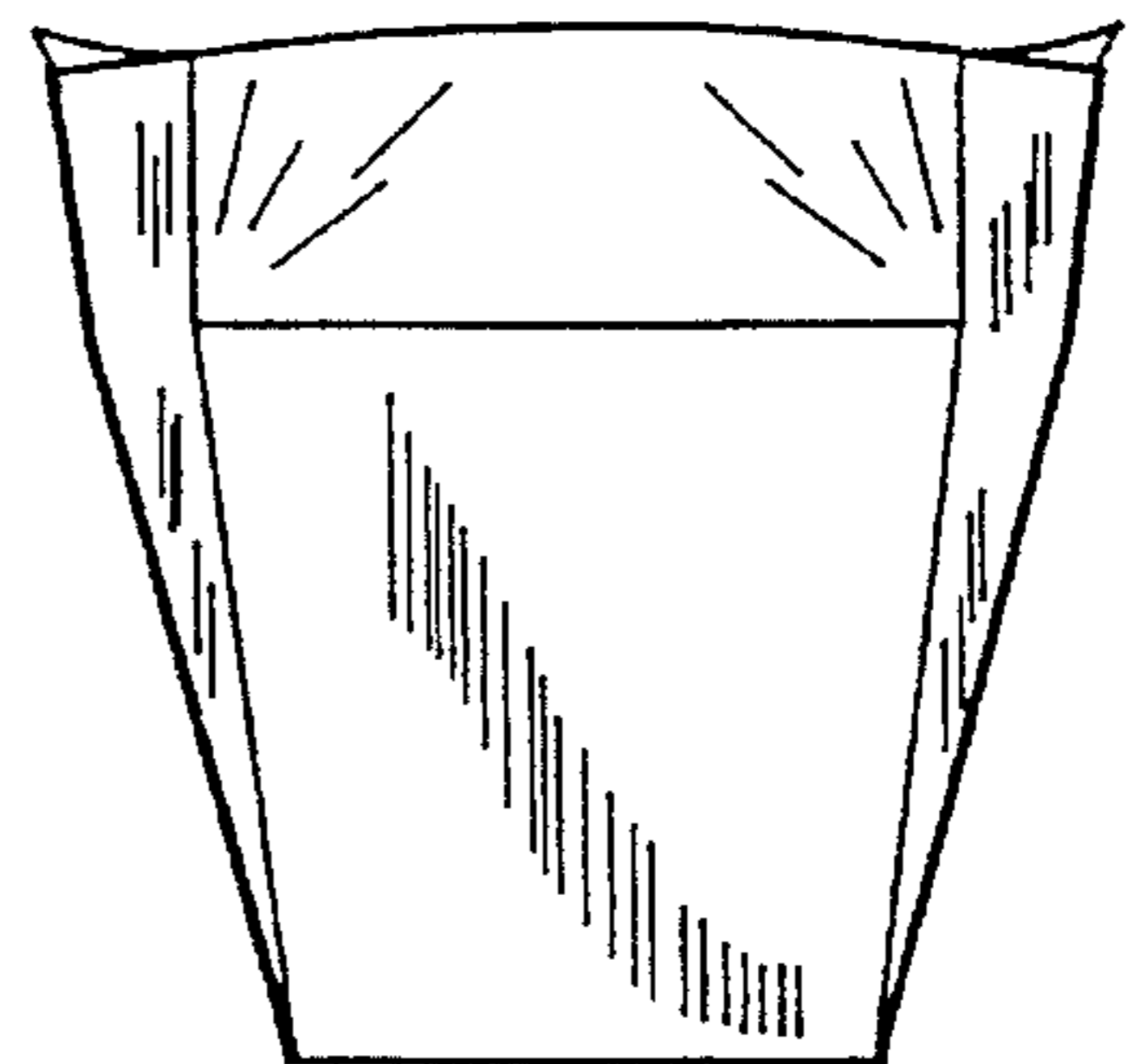

FIG. 6

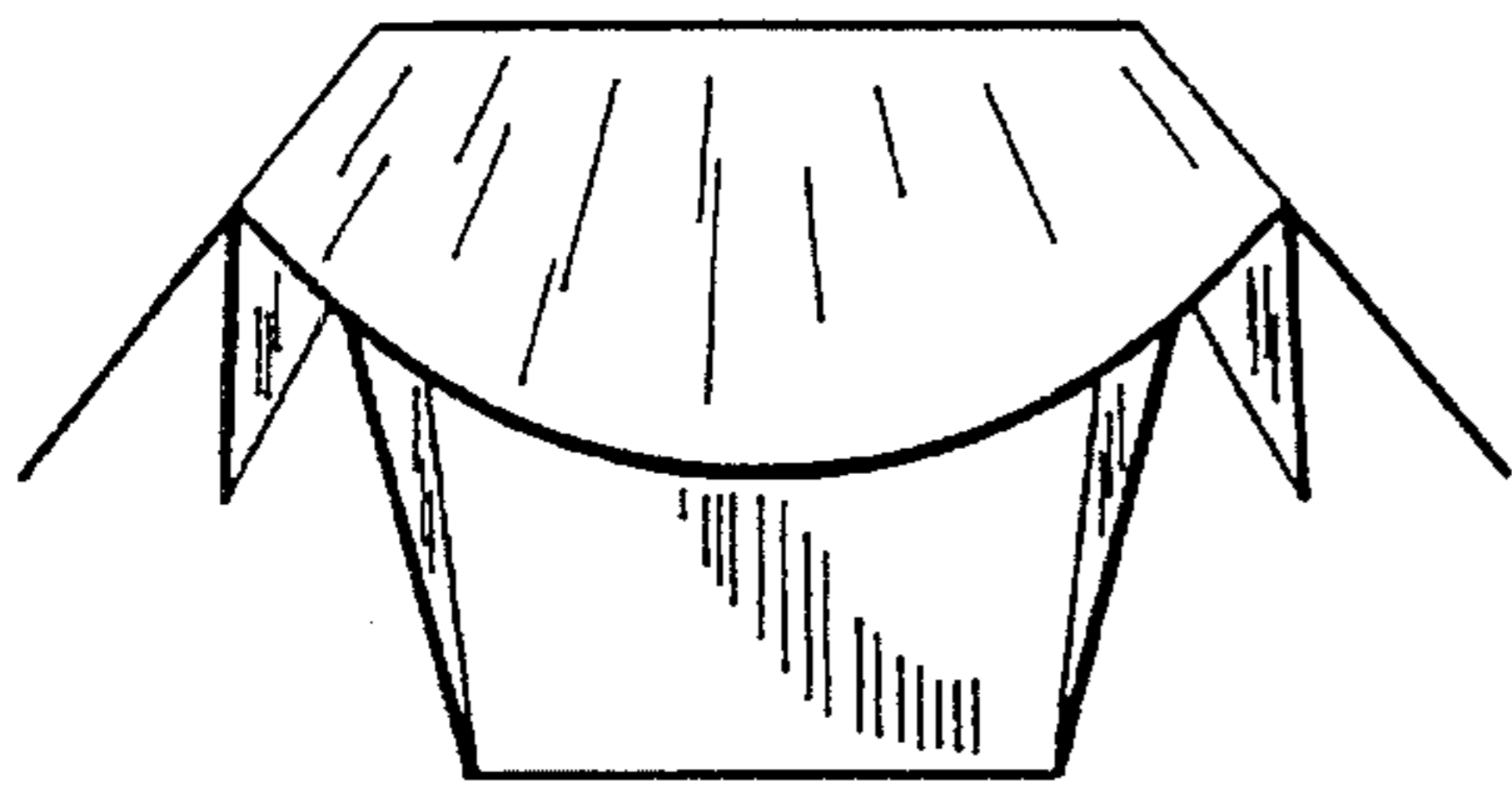

FIG. 7

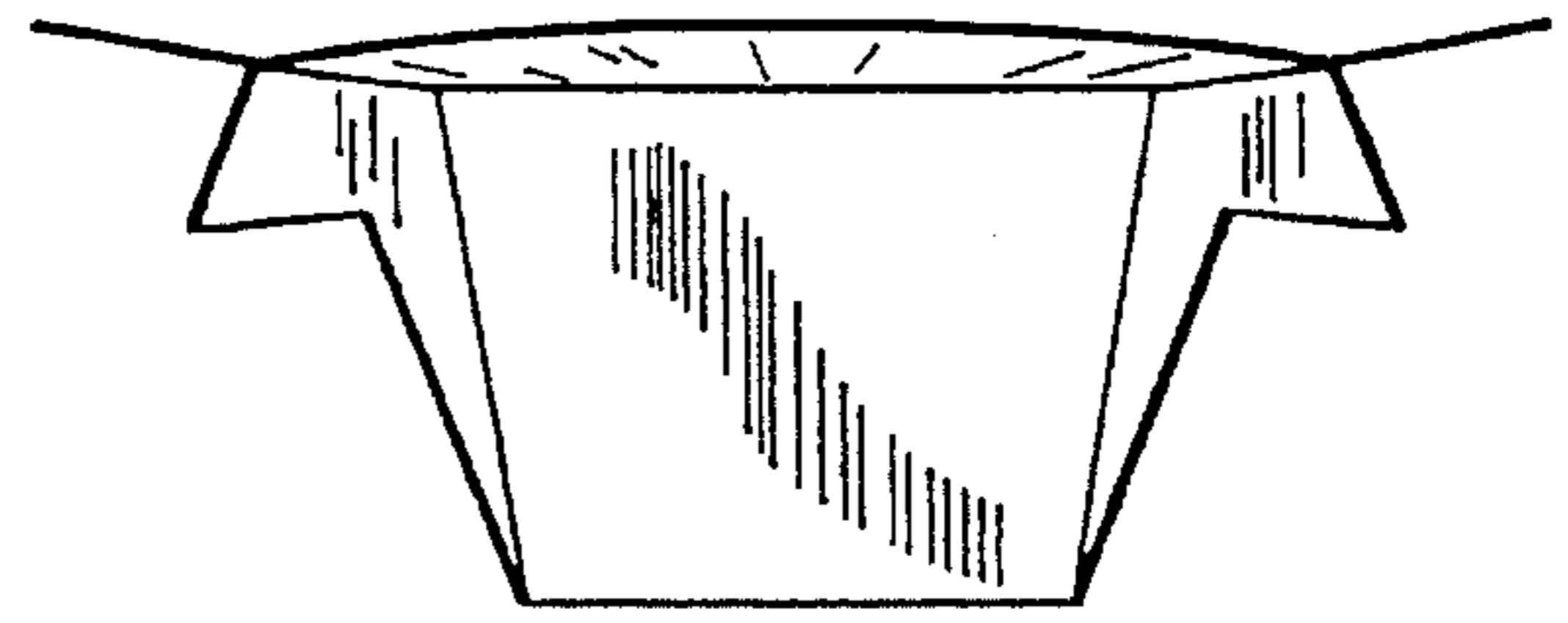

FIG. 8

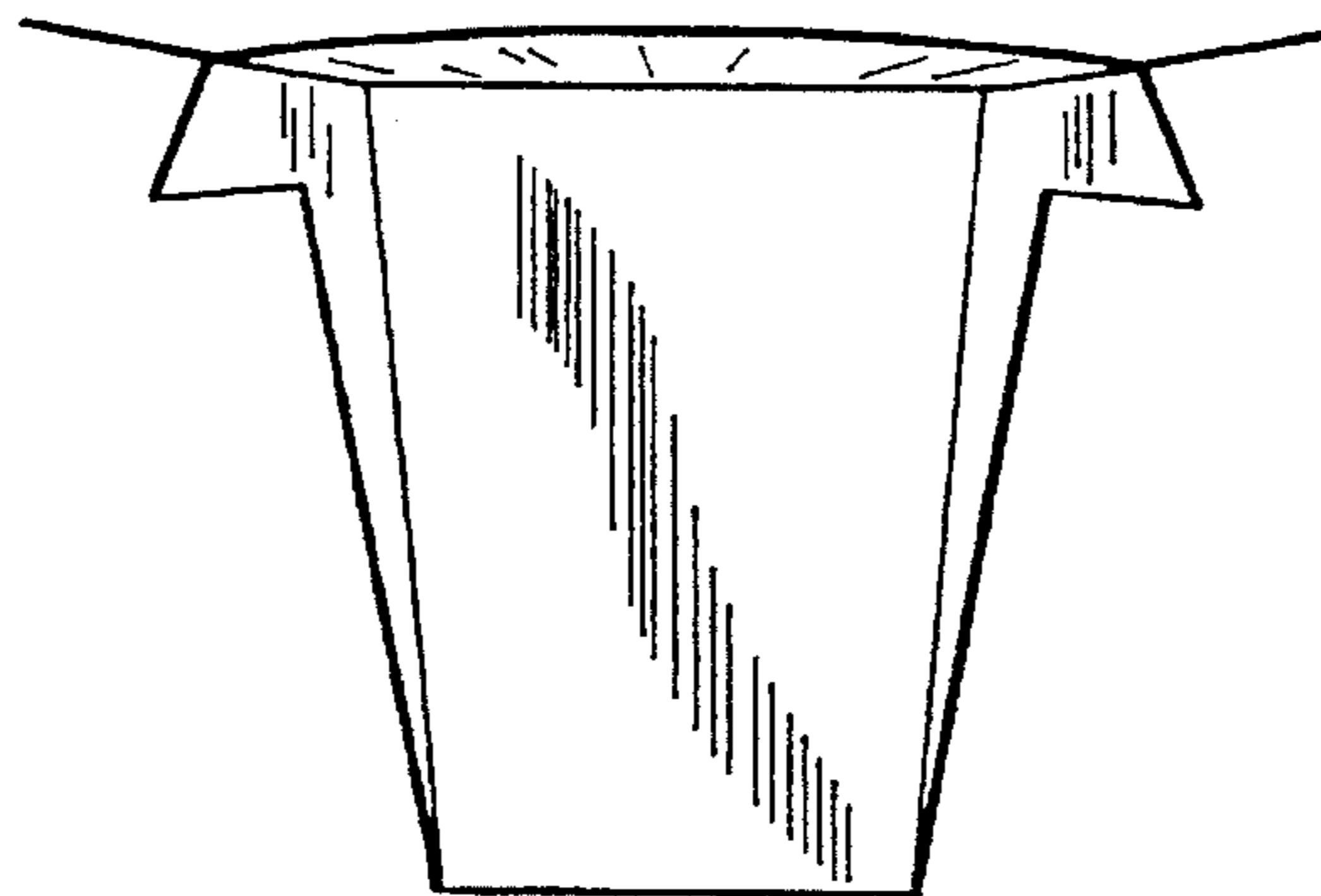

FIG. 9

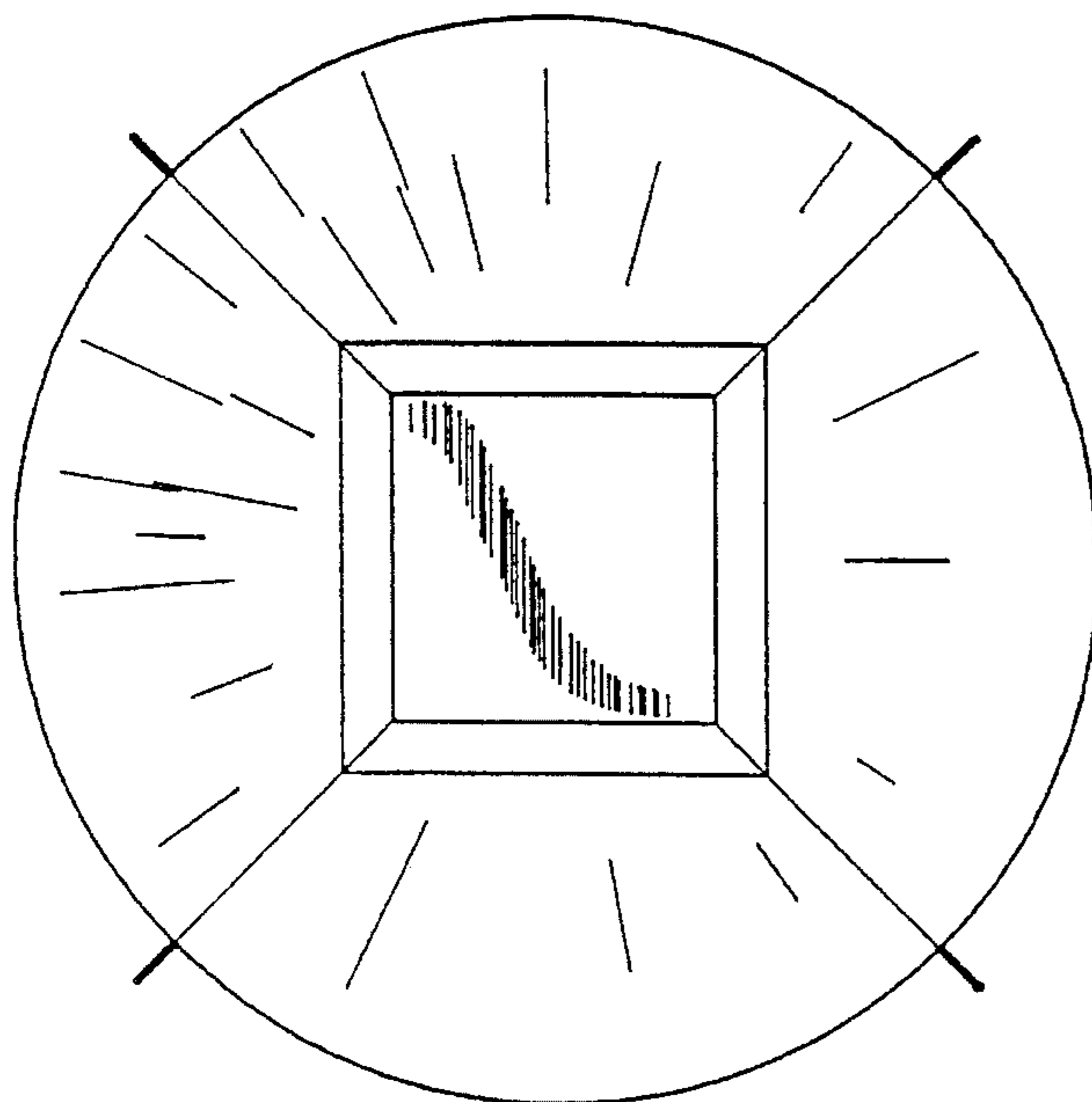

FIG. 10

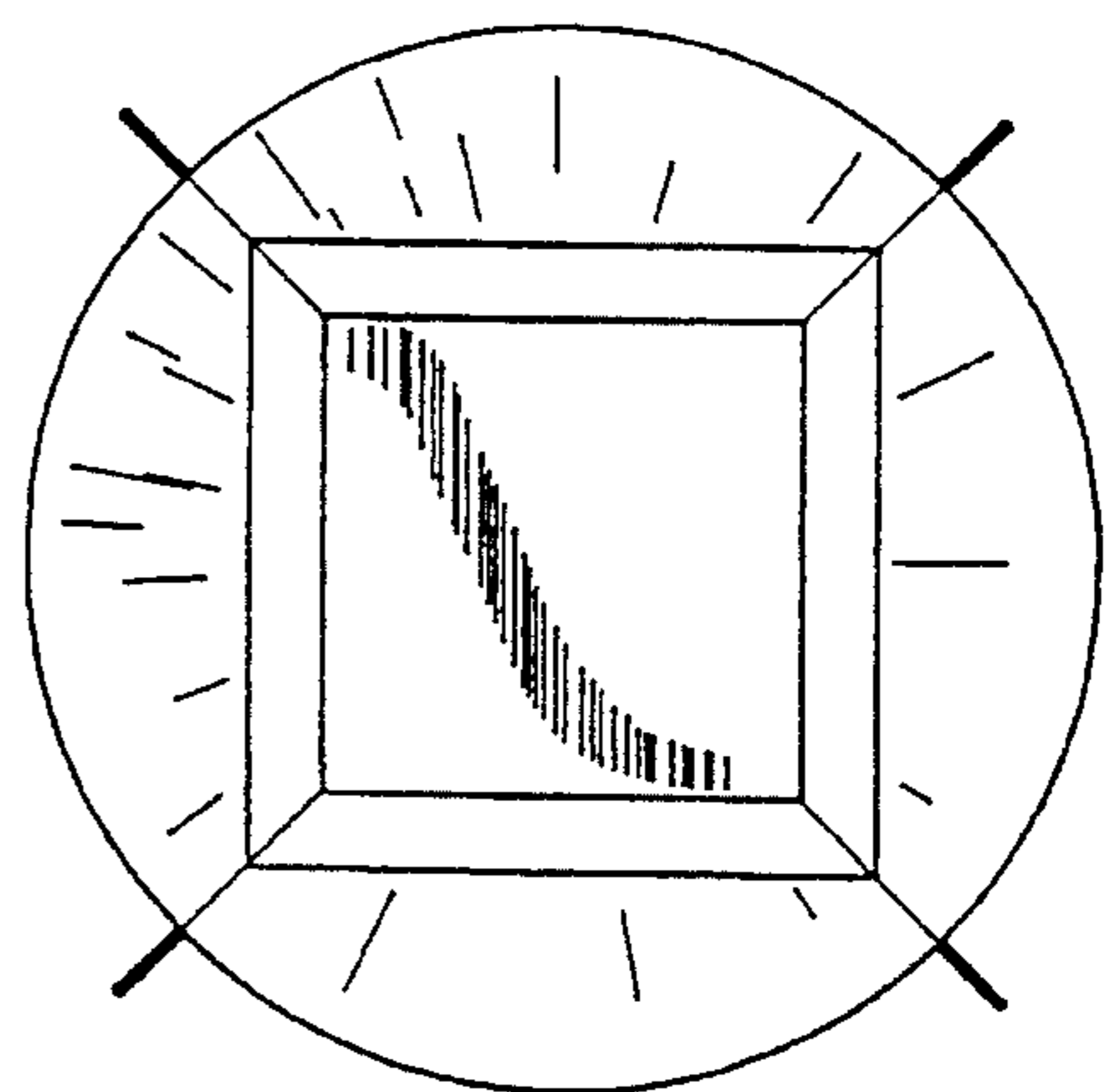

FIG. 11

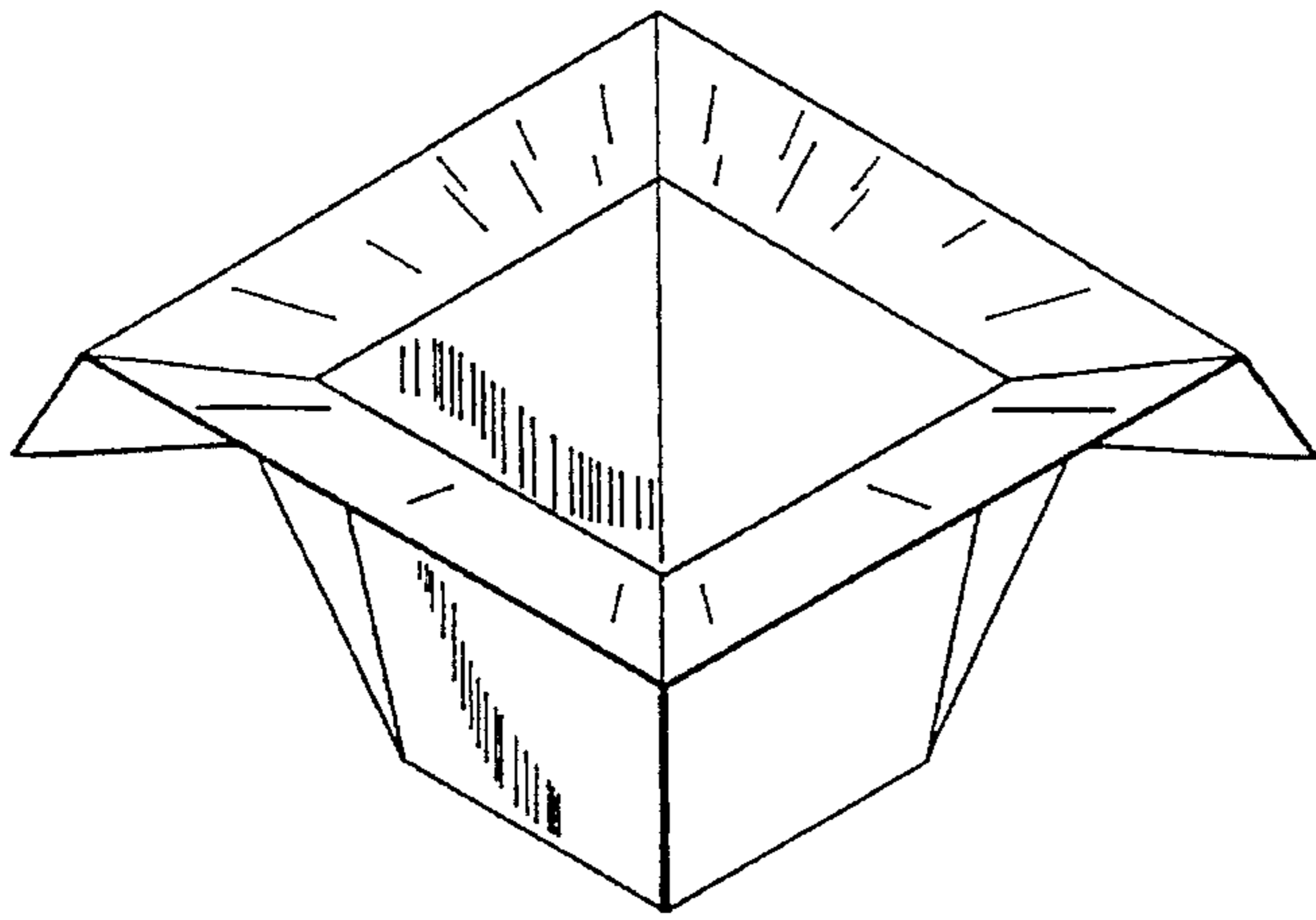

FIG. 12

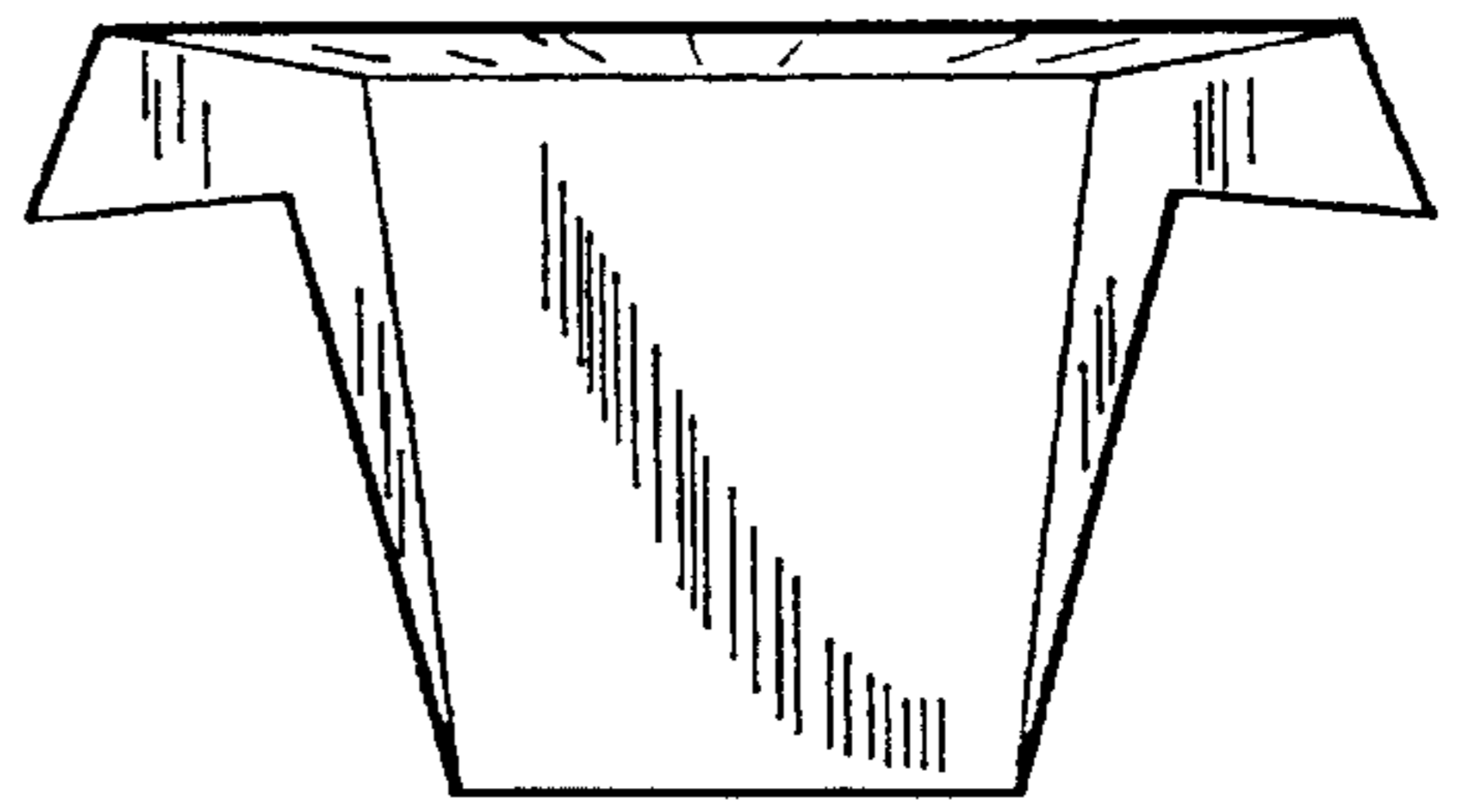

FIG. 13

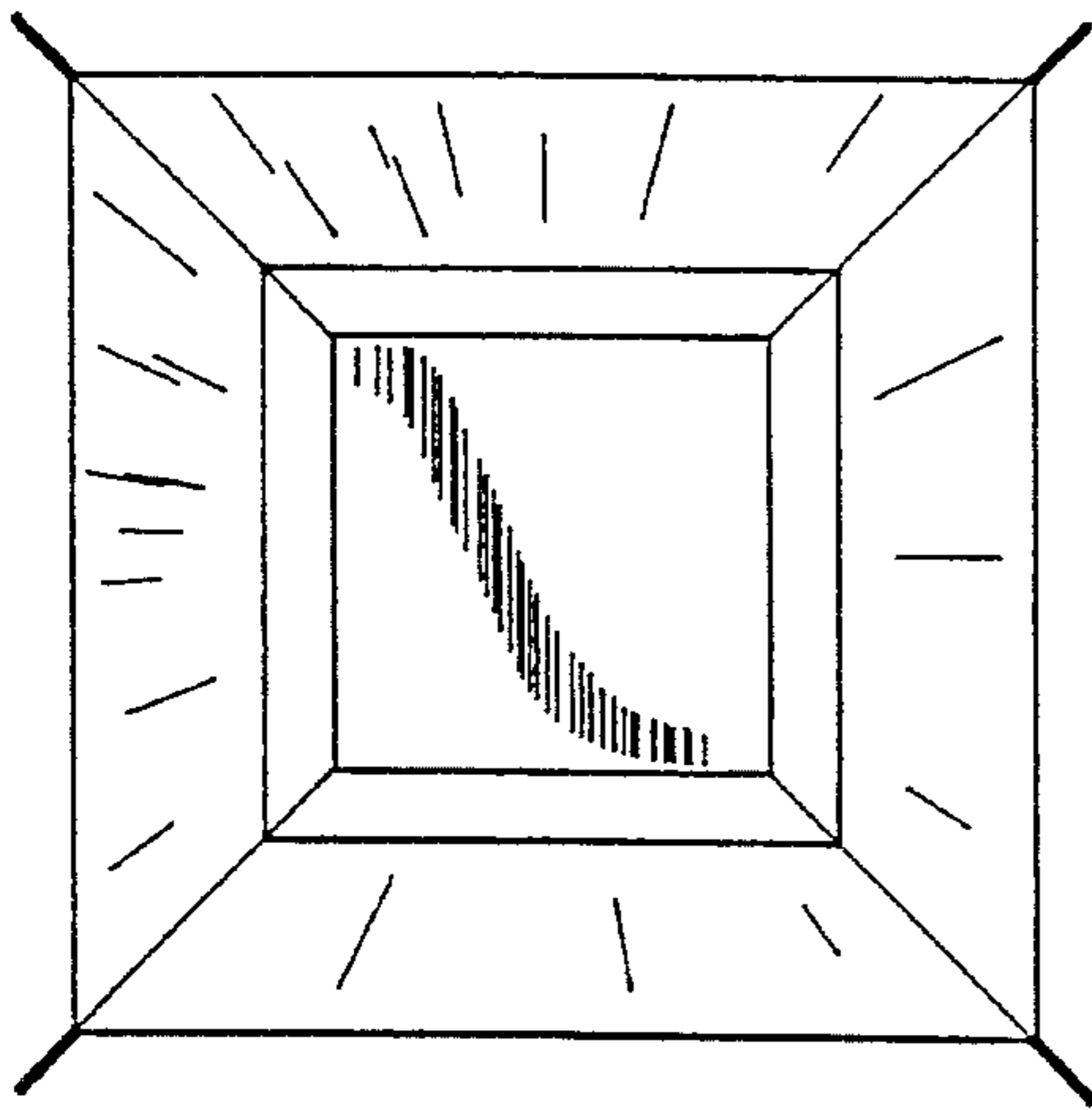

FIG. 14

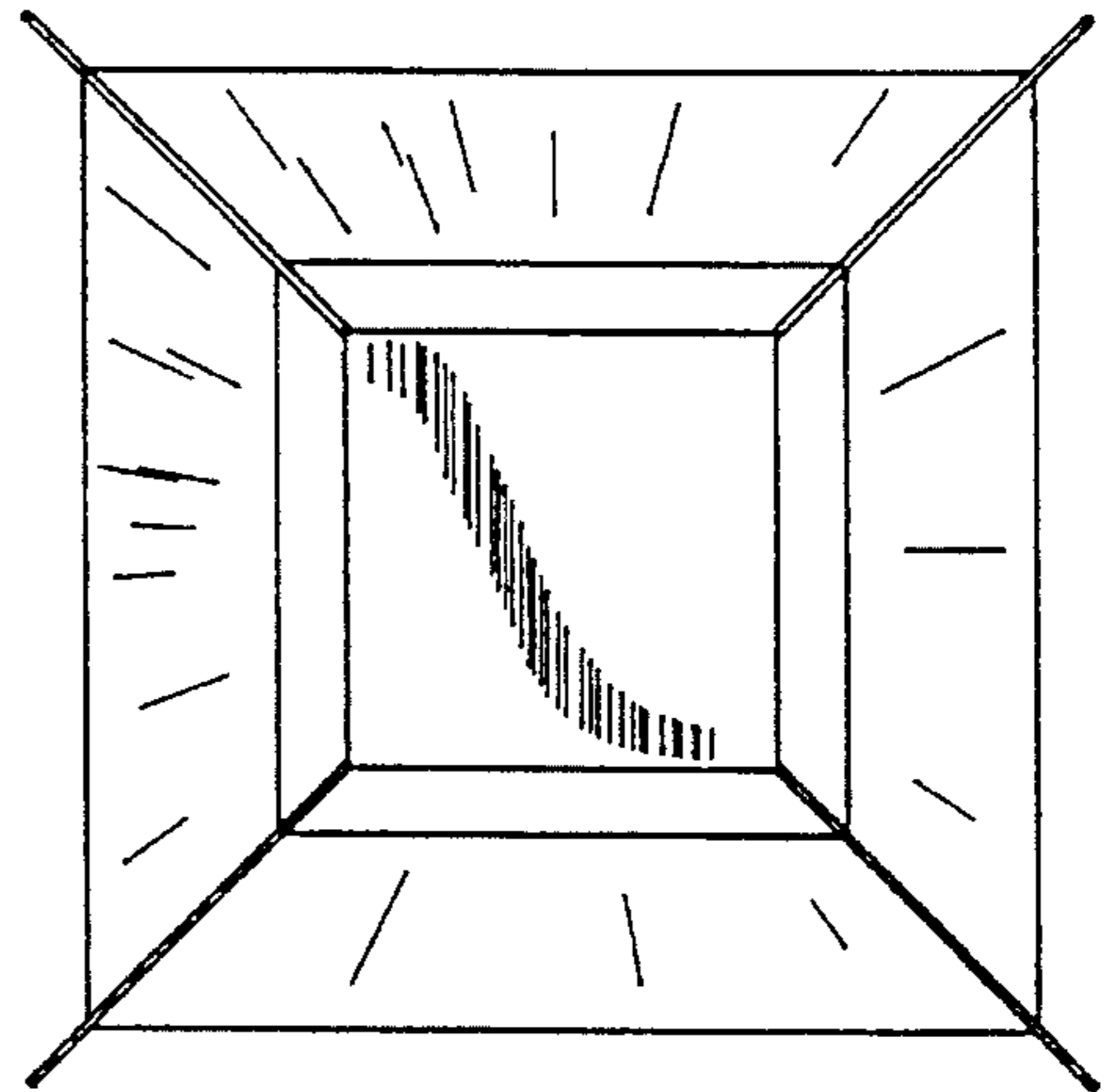

FIG. 15

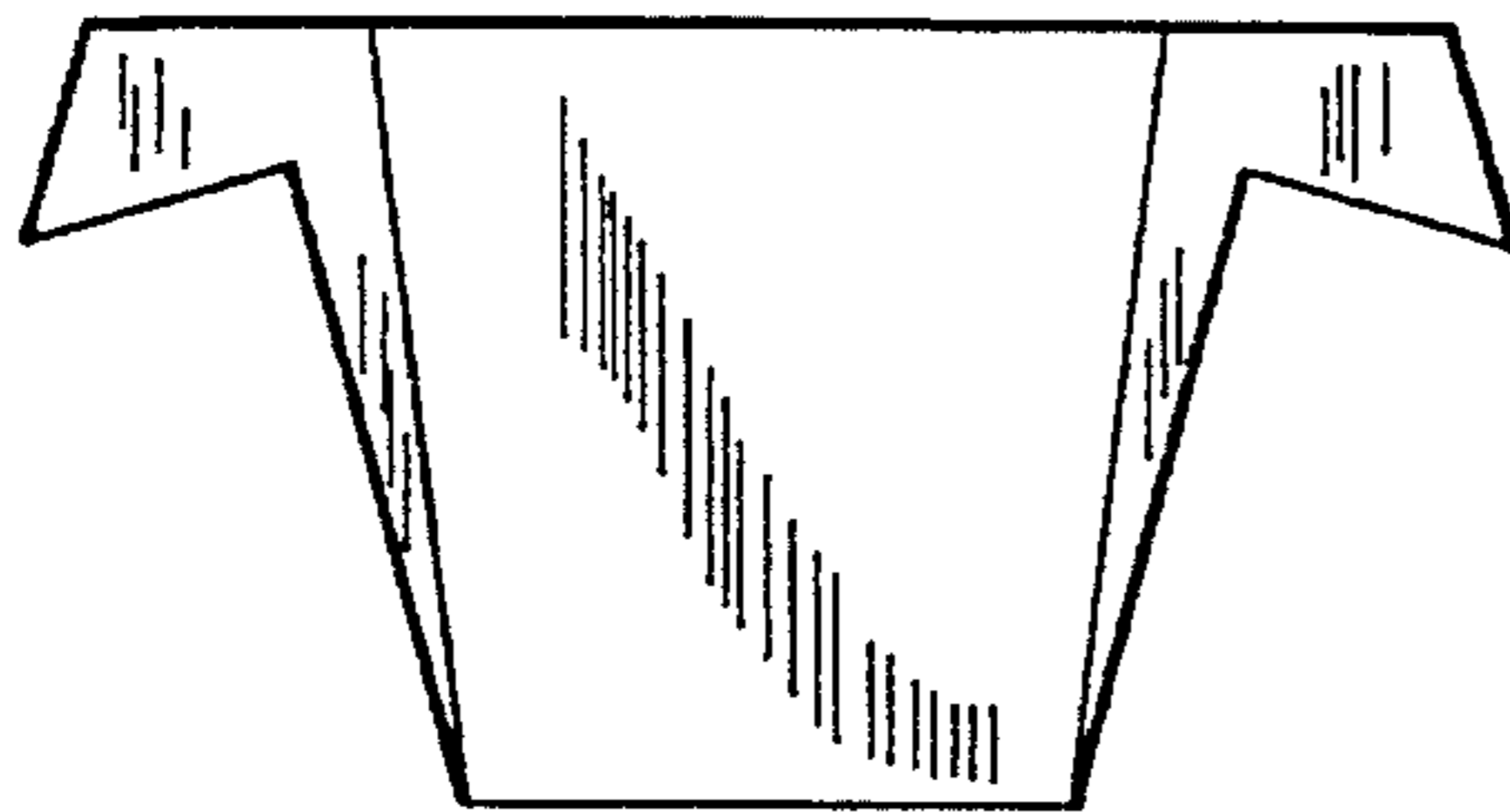

FIG. 16

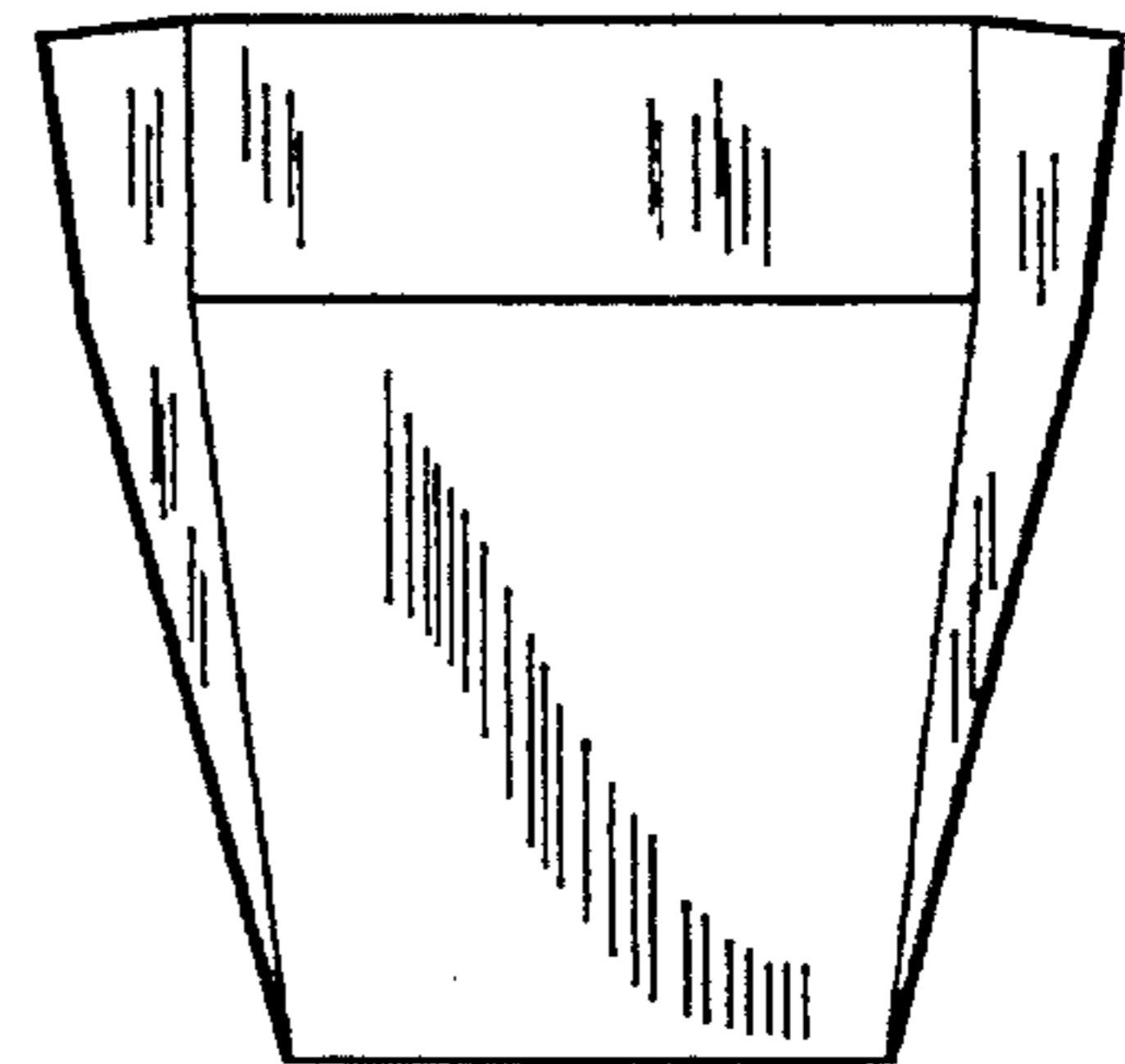

FIG. 17

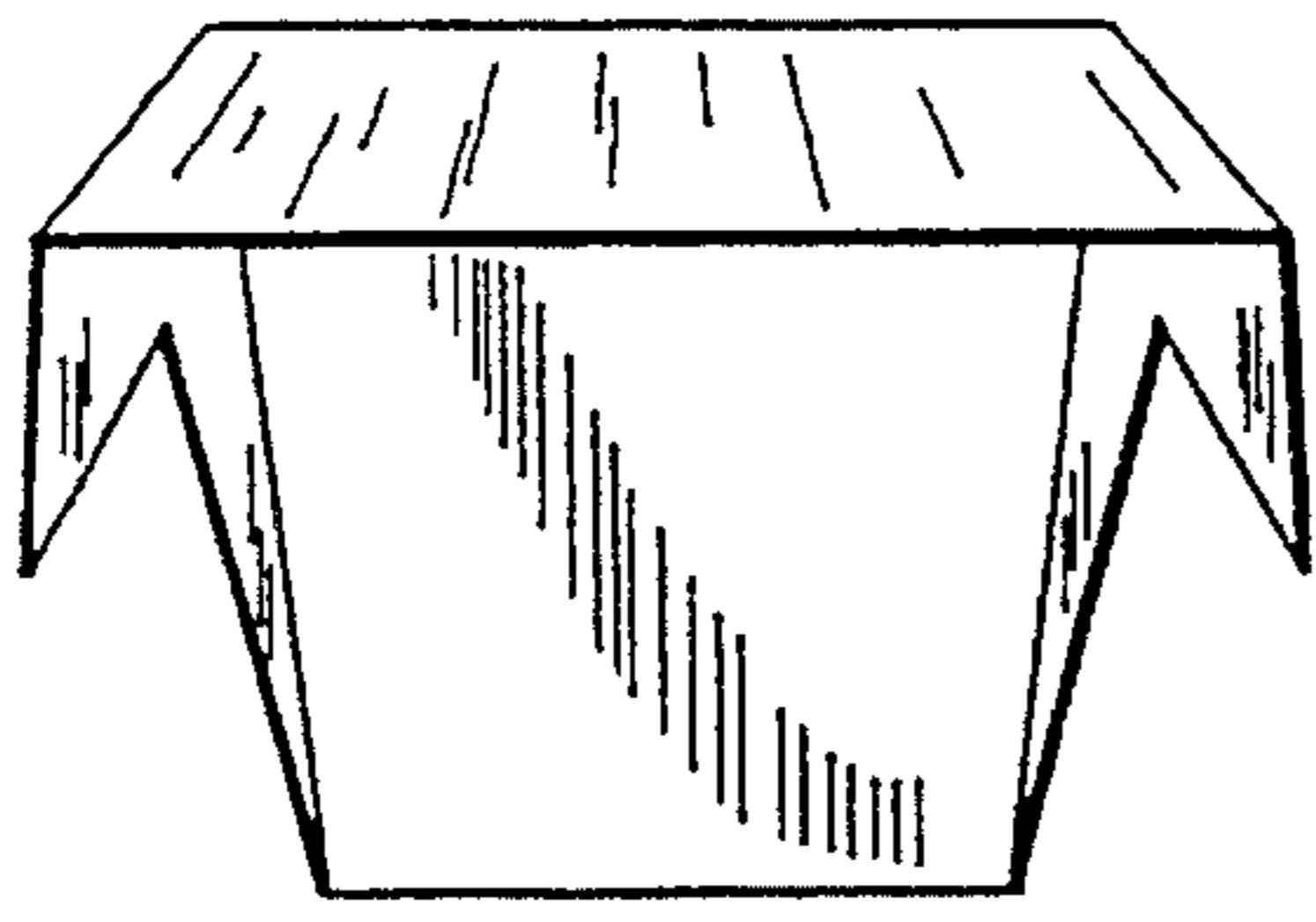

FIG. 18

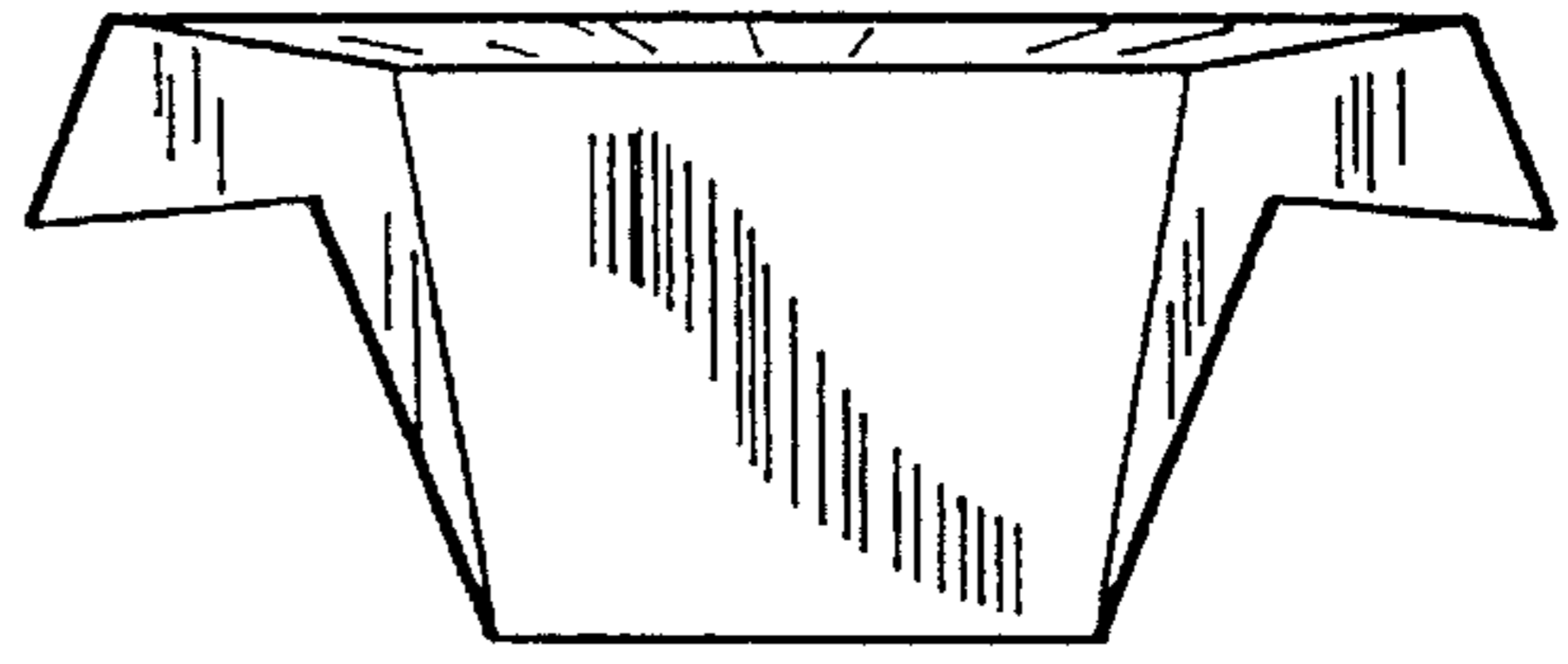

FIG. 19

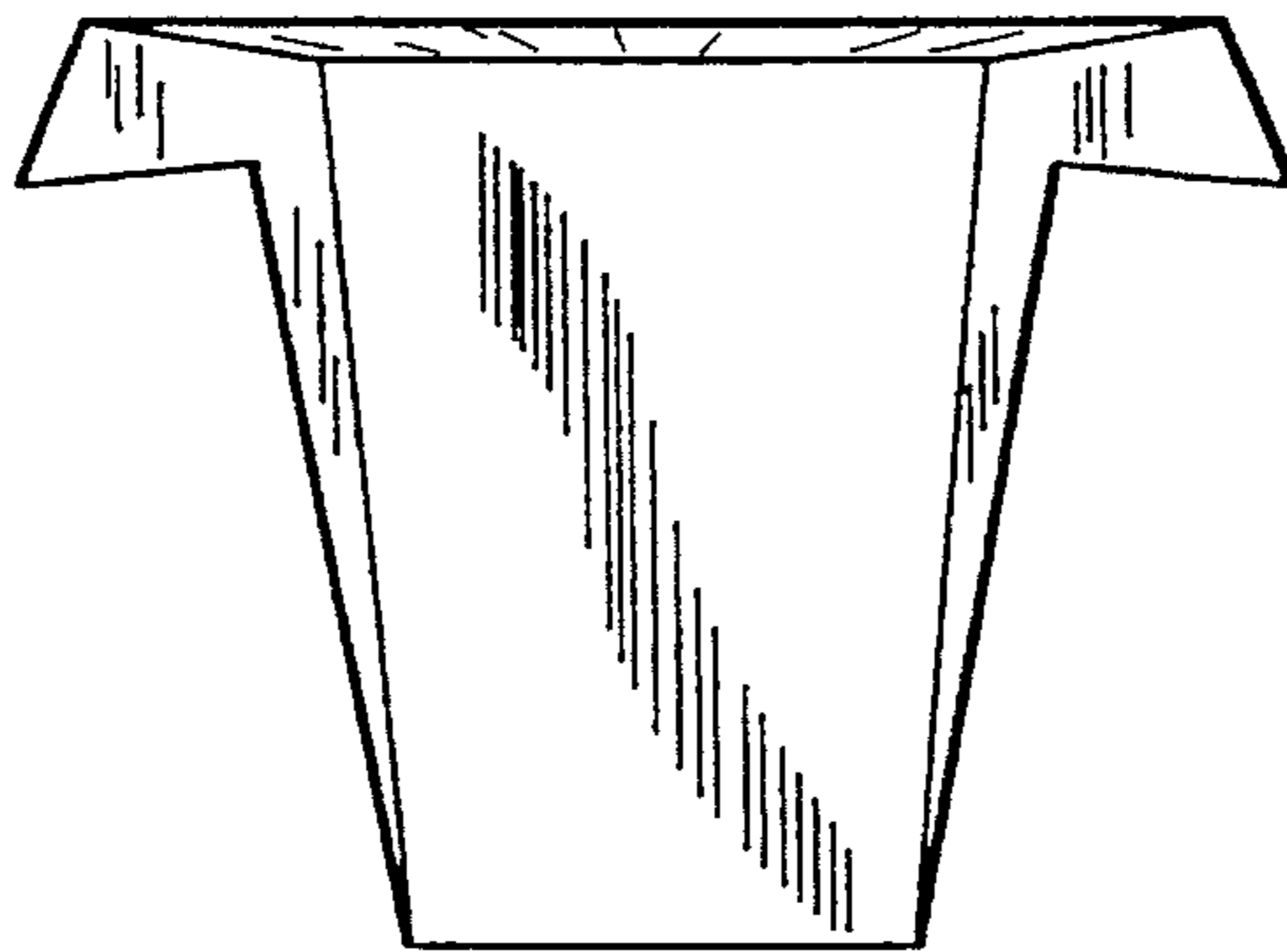

FIG. 20

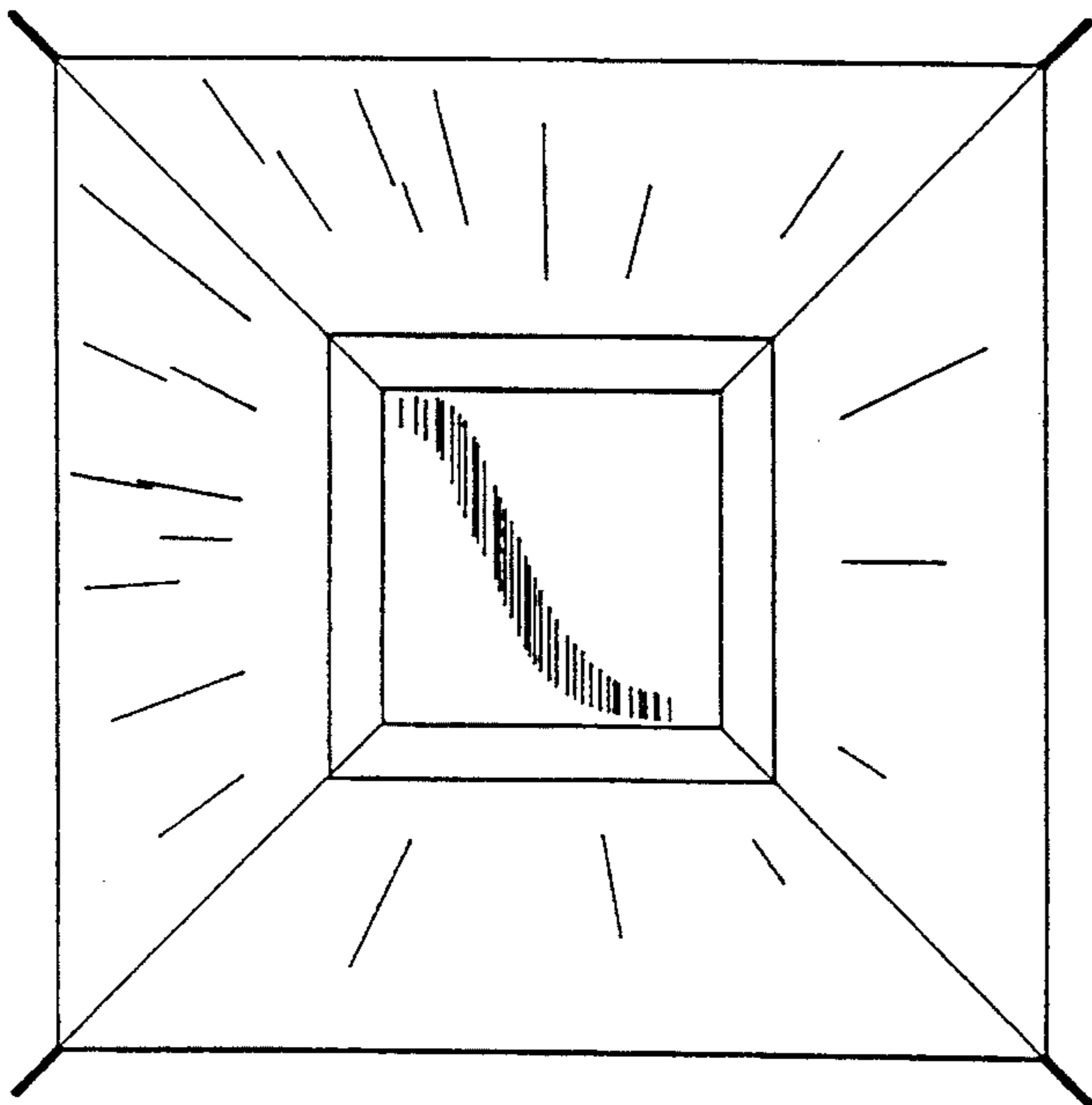

FIG. 21

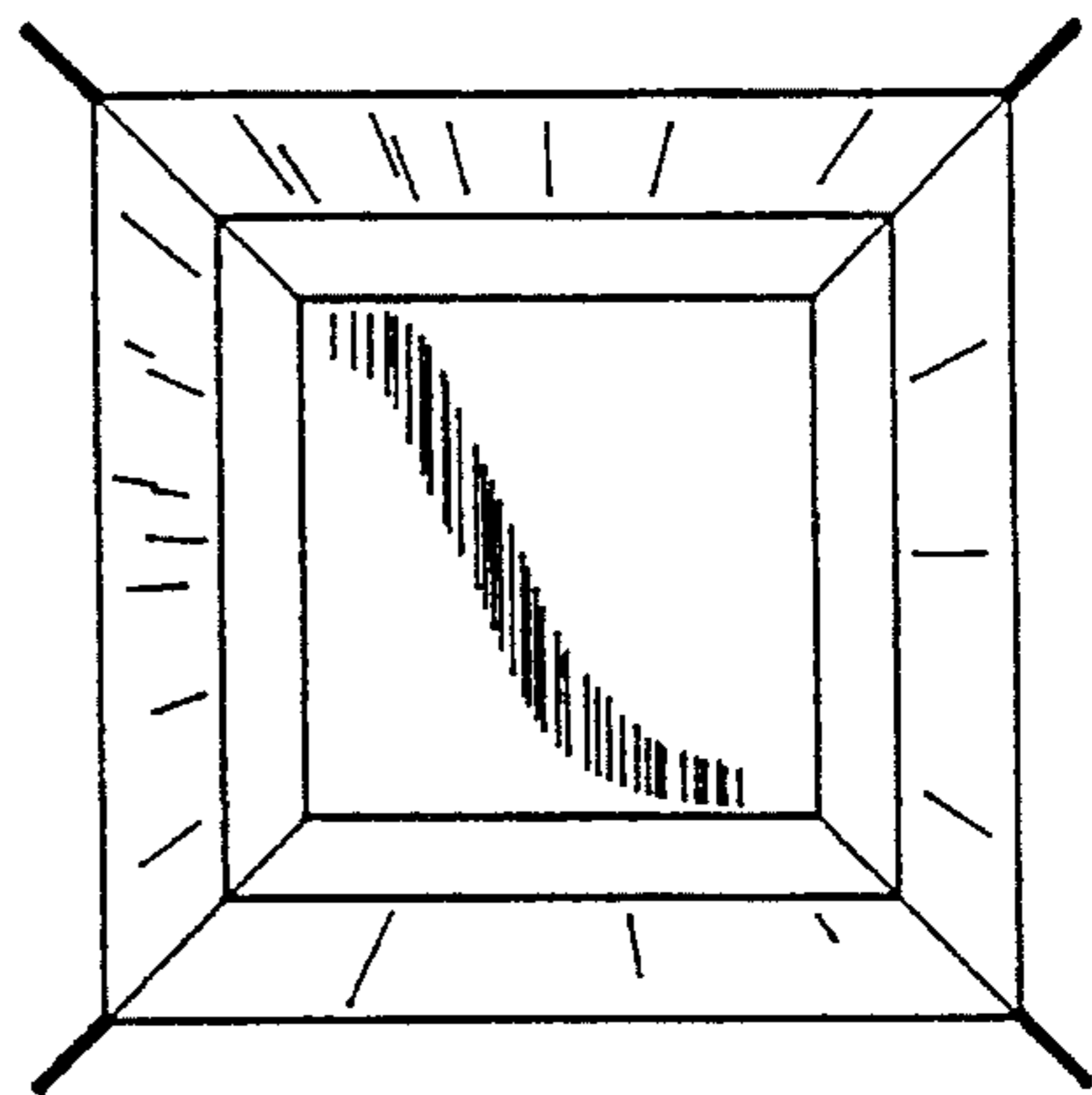

FIG. 22

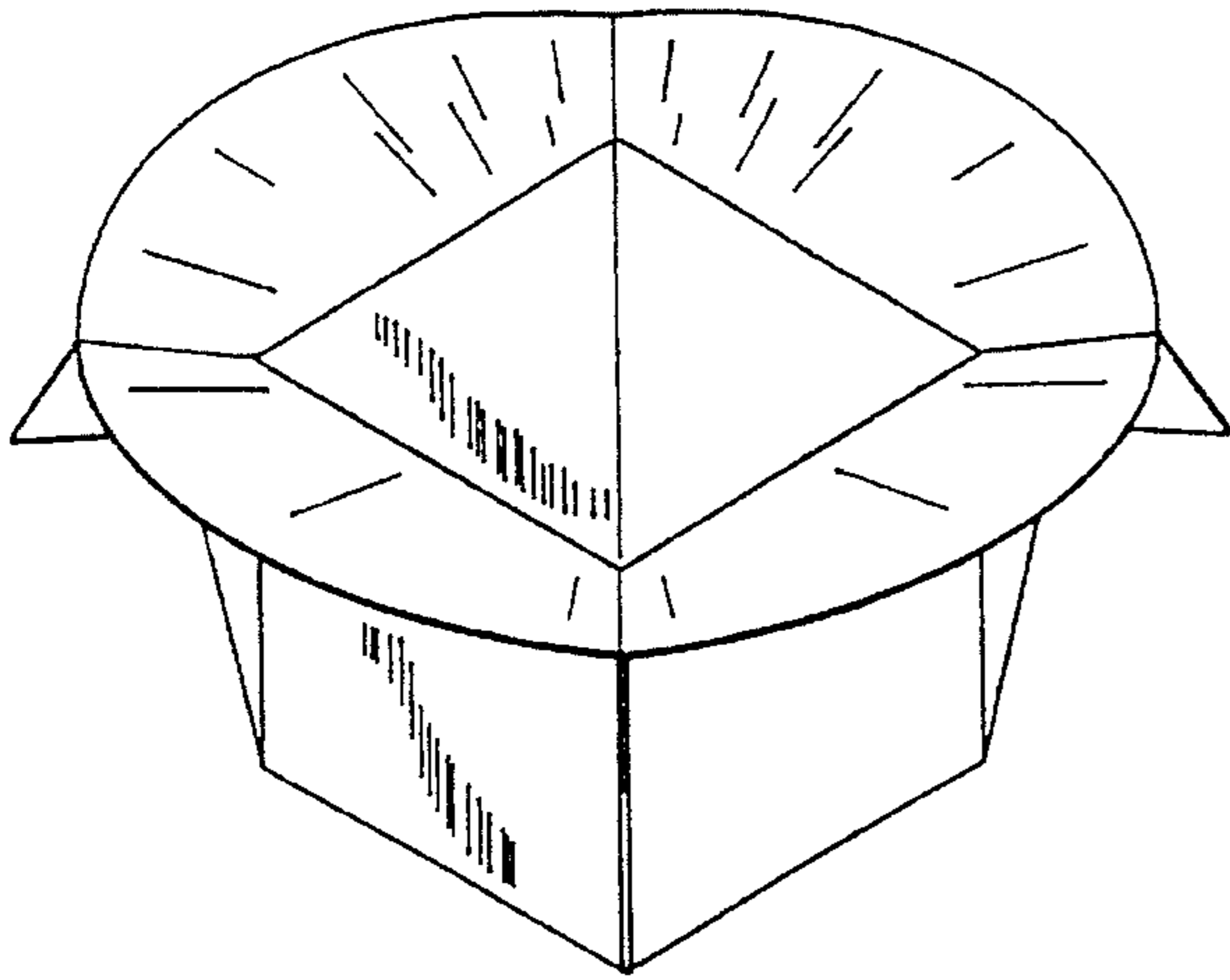

FIG. 23

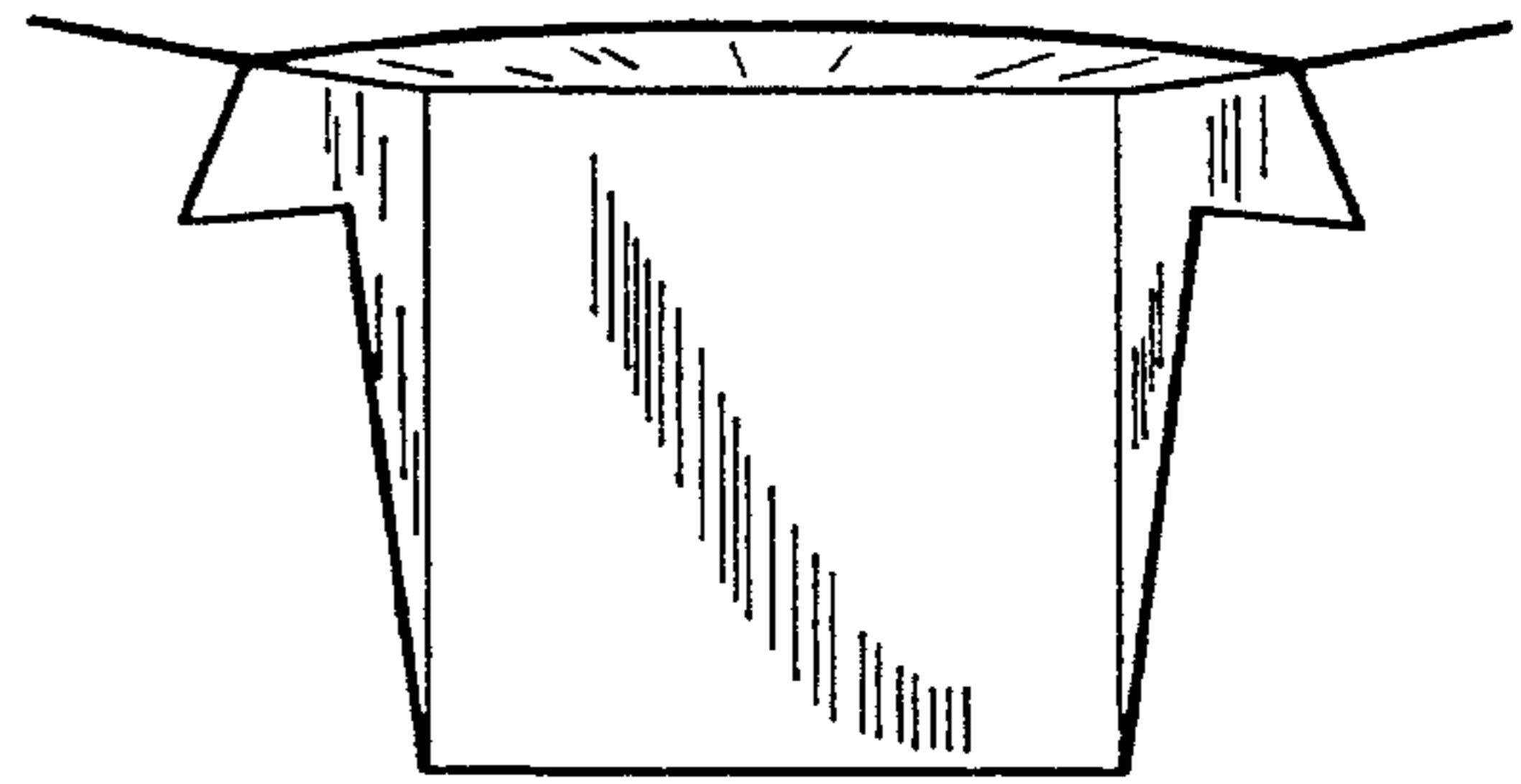

FIG. 24

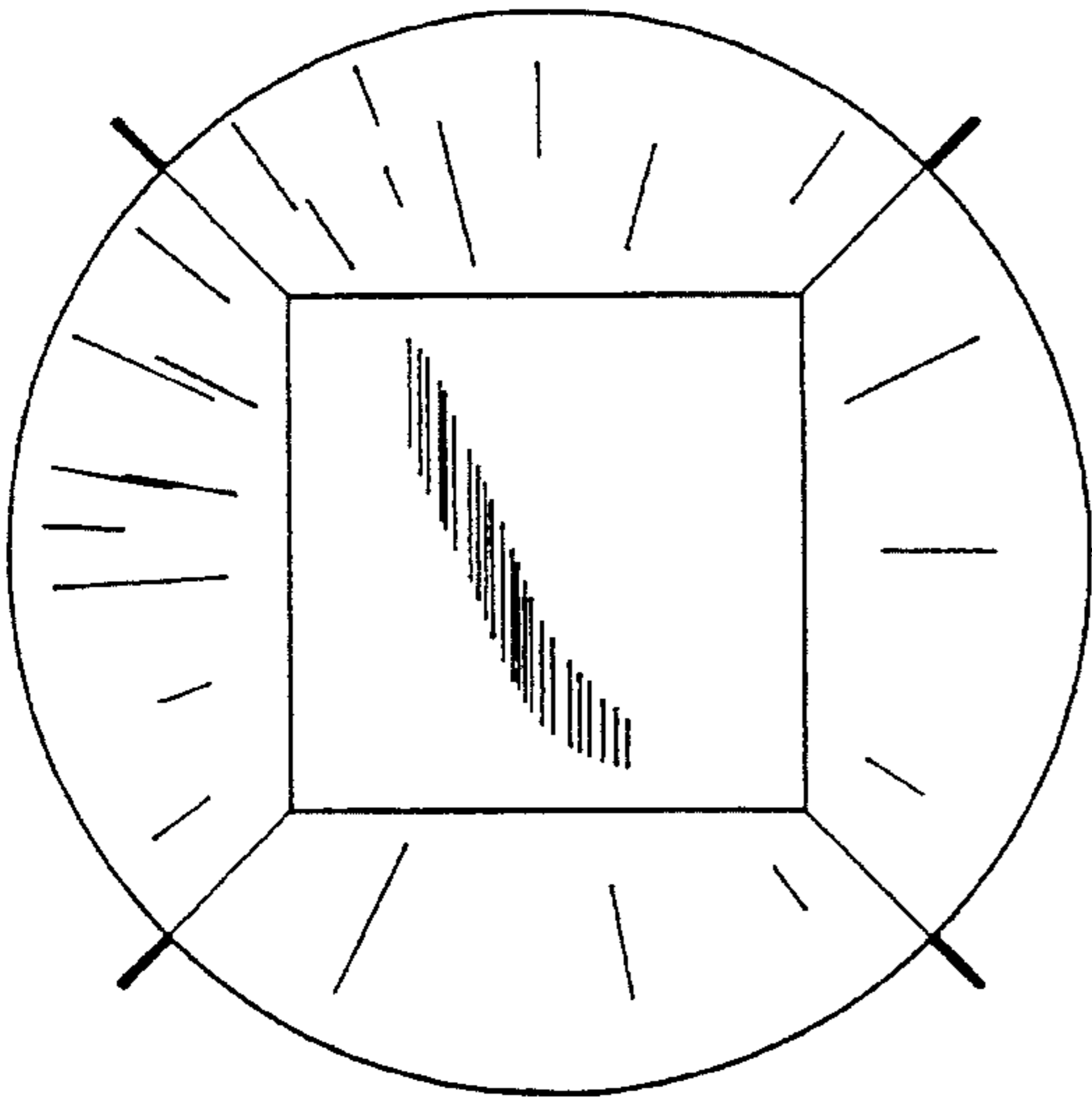

FIG. 25

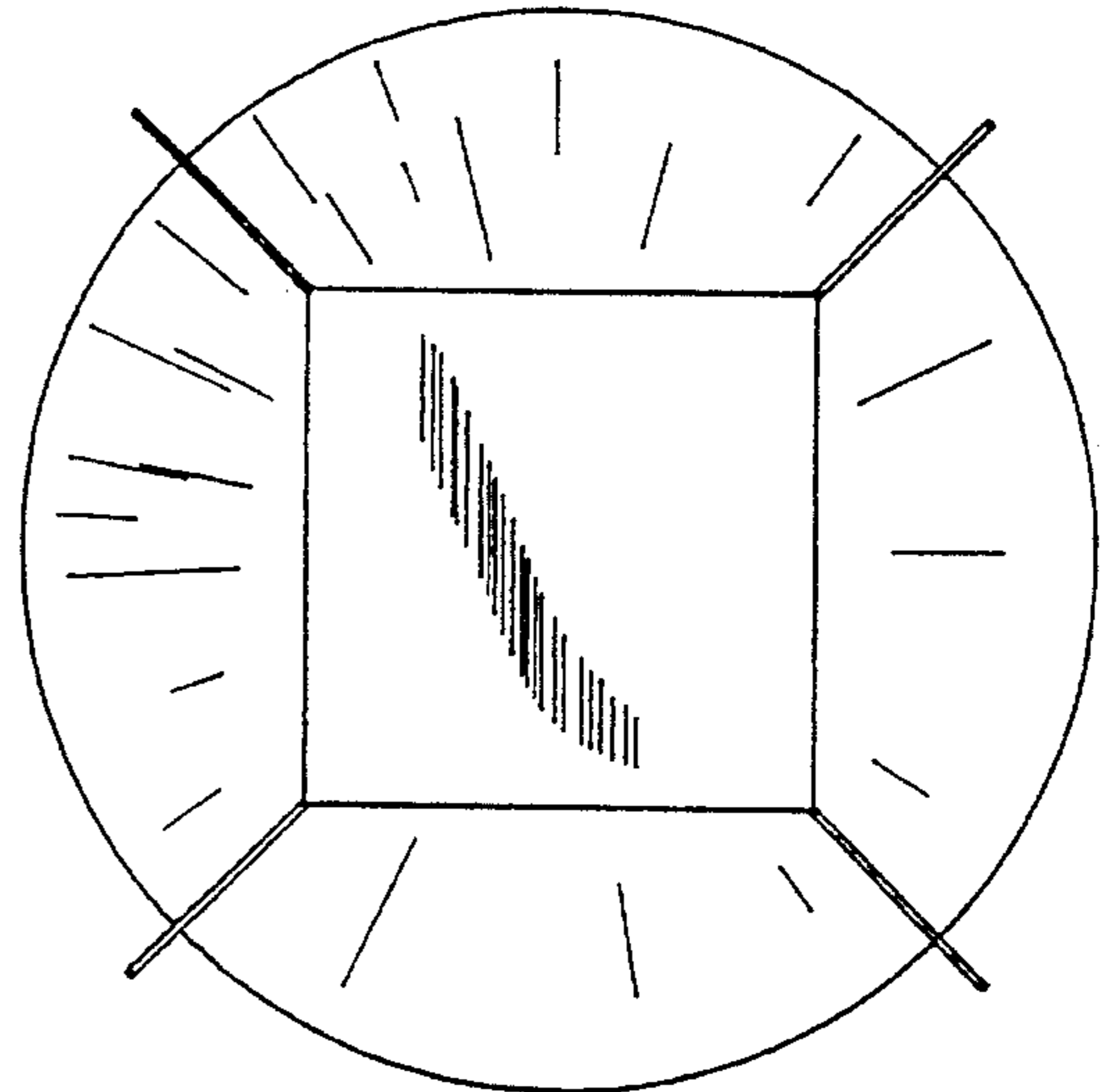

FIG. 26

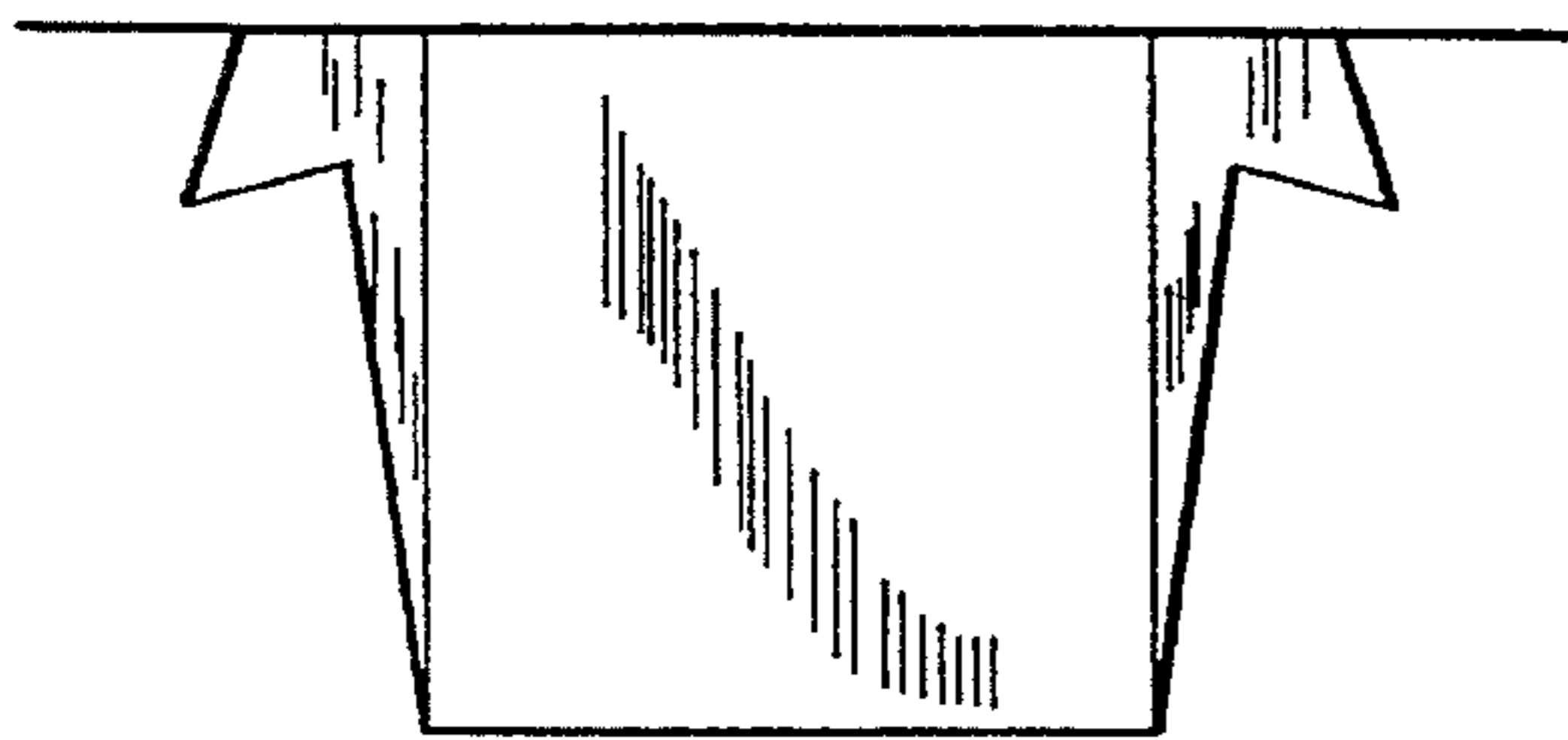

FIG. 27

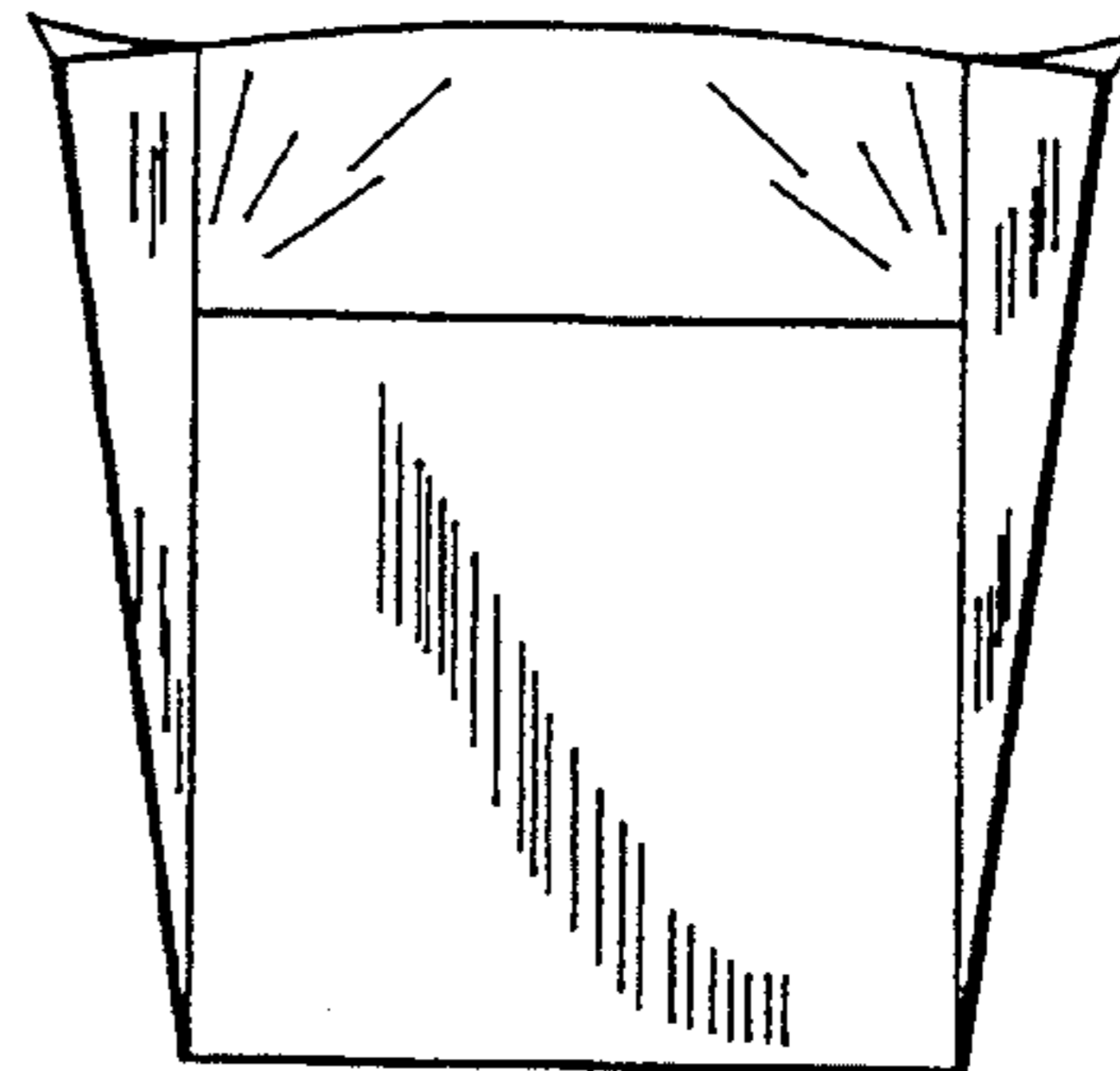

FIG. 28

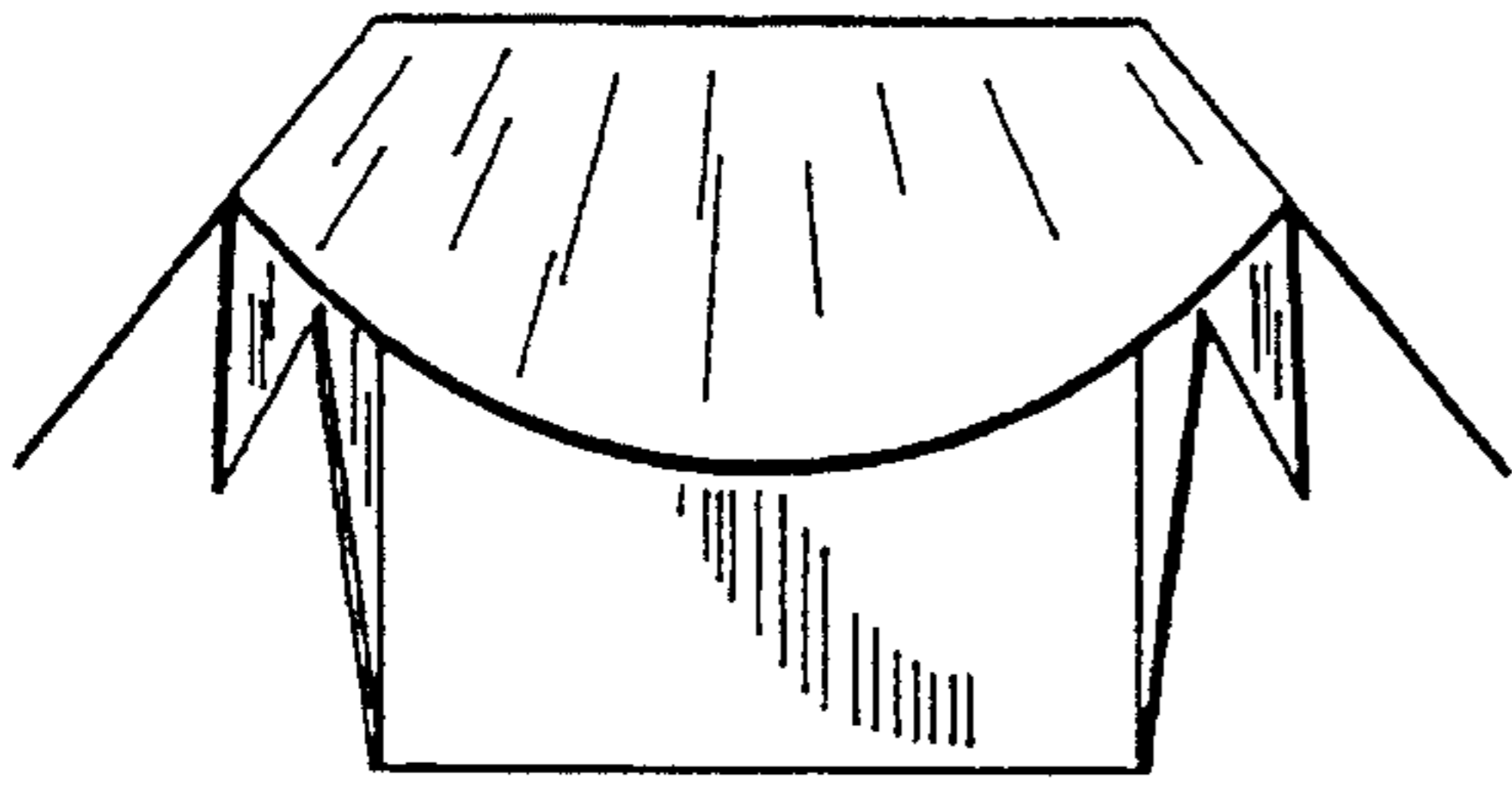

FIG. 28

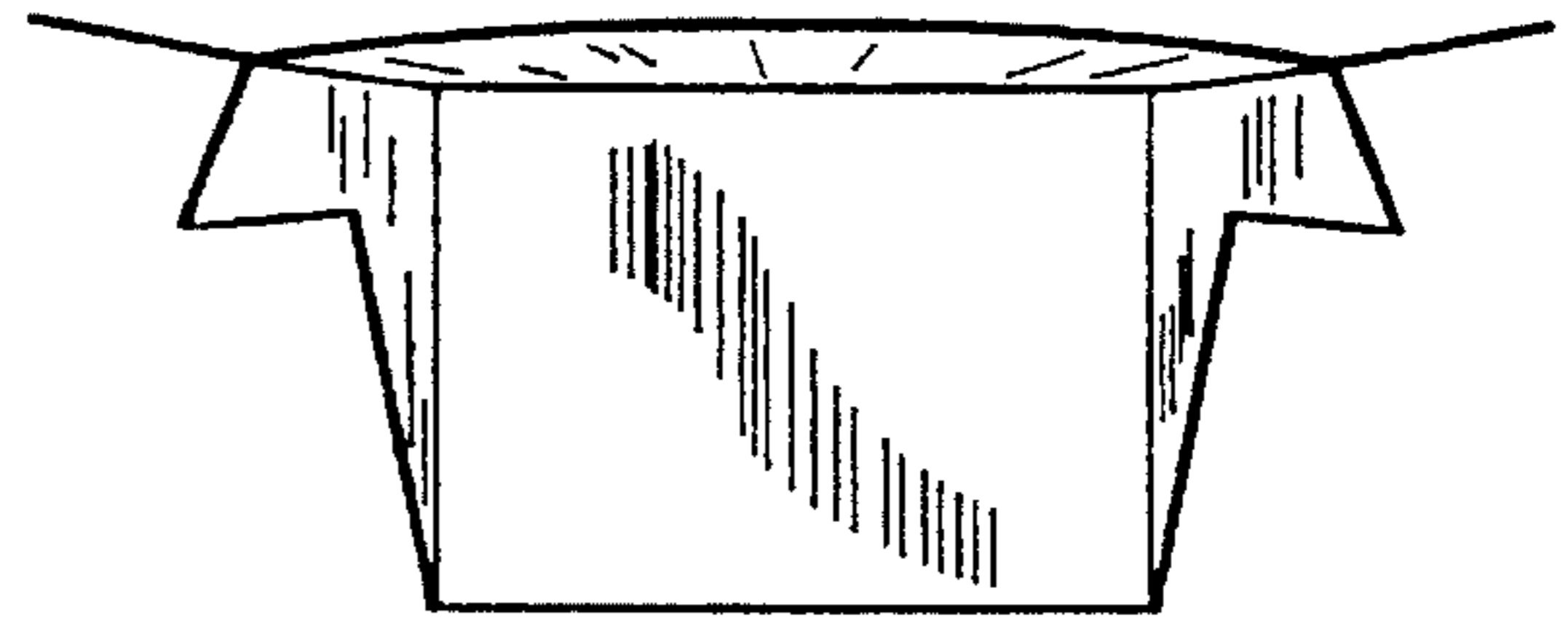

FIG. 30

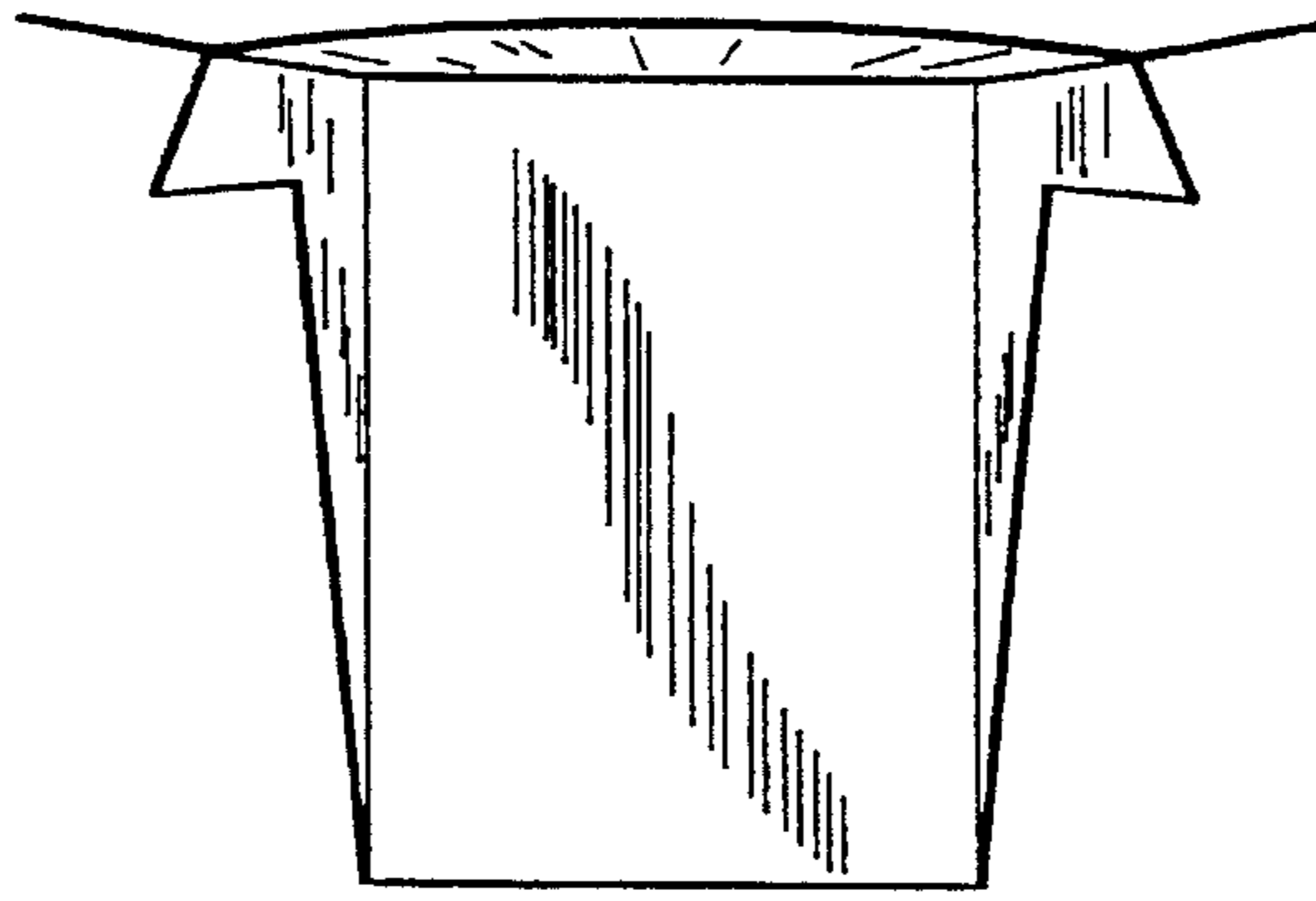

FIG. 31

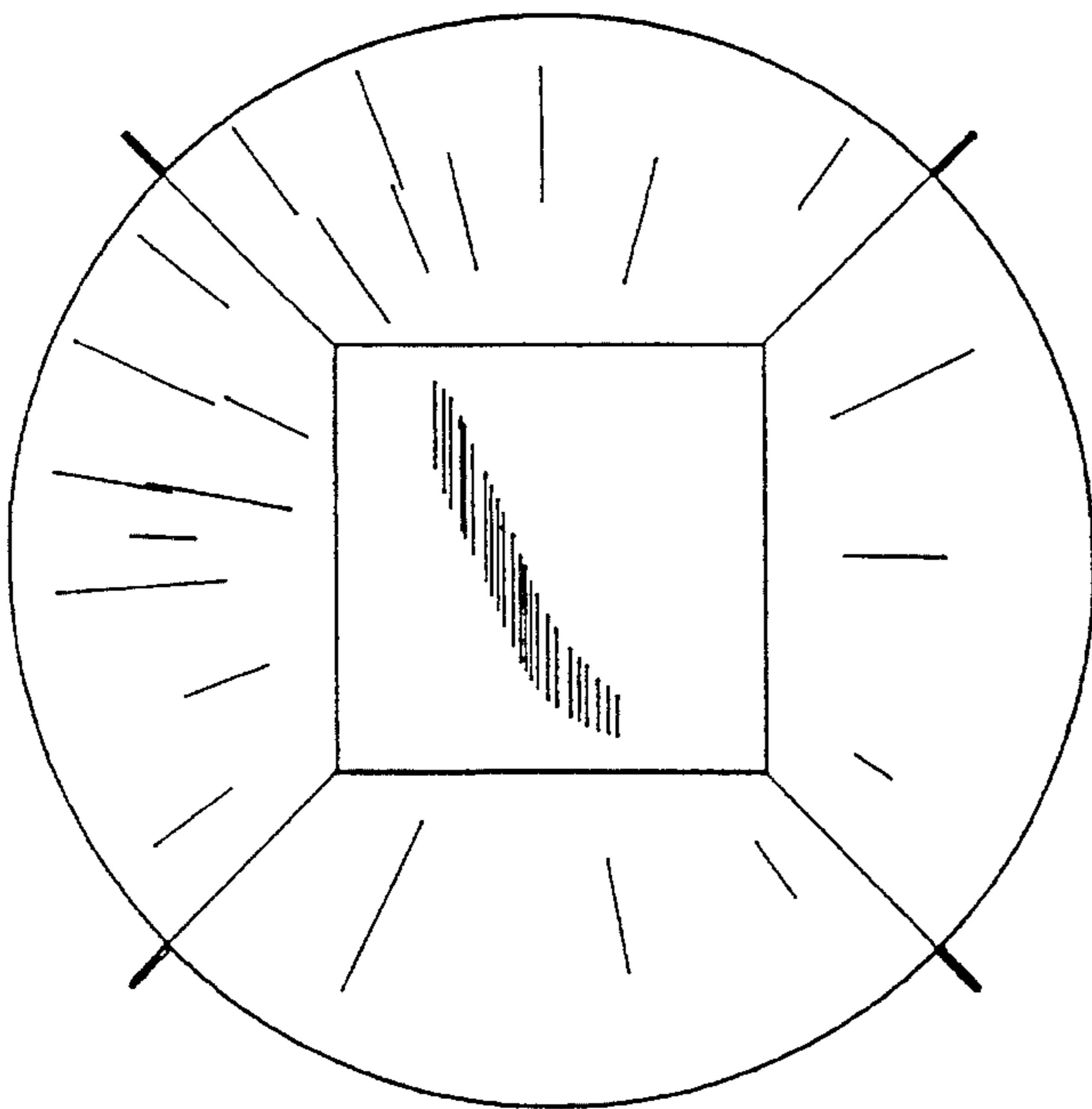

FIG. 32

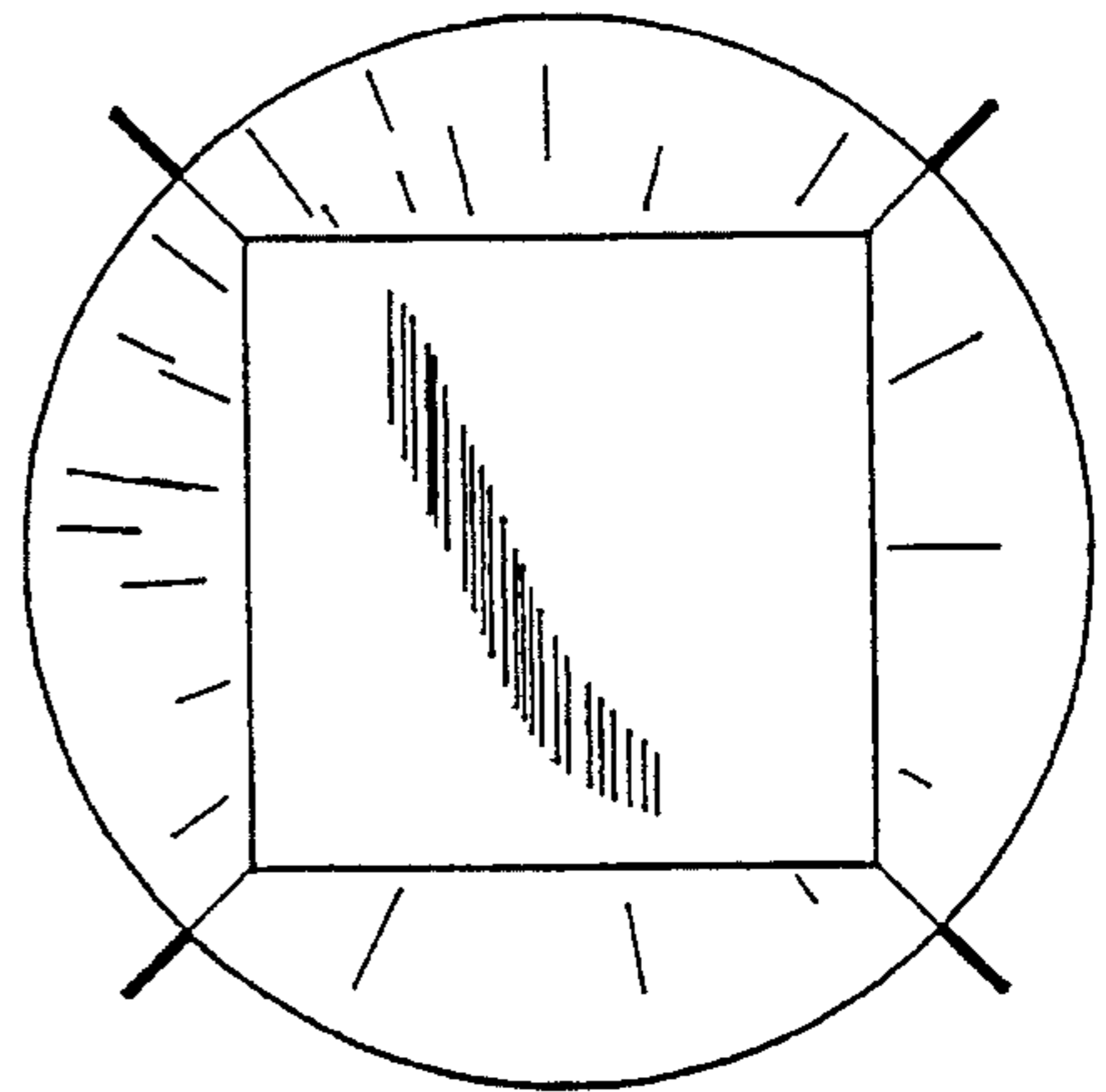

FIG. 33

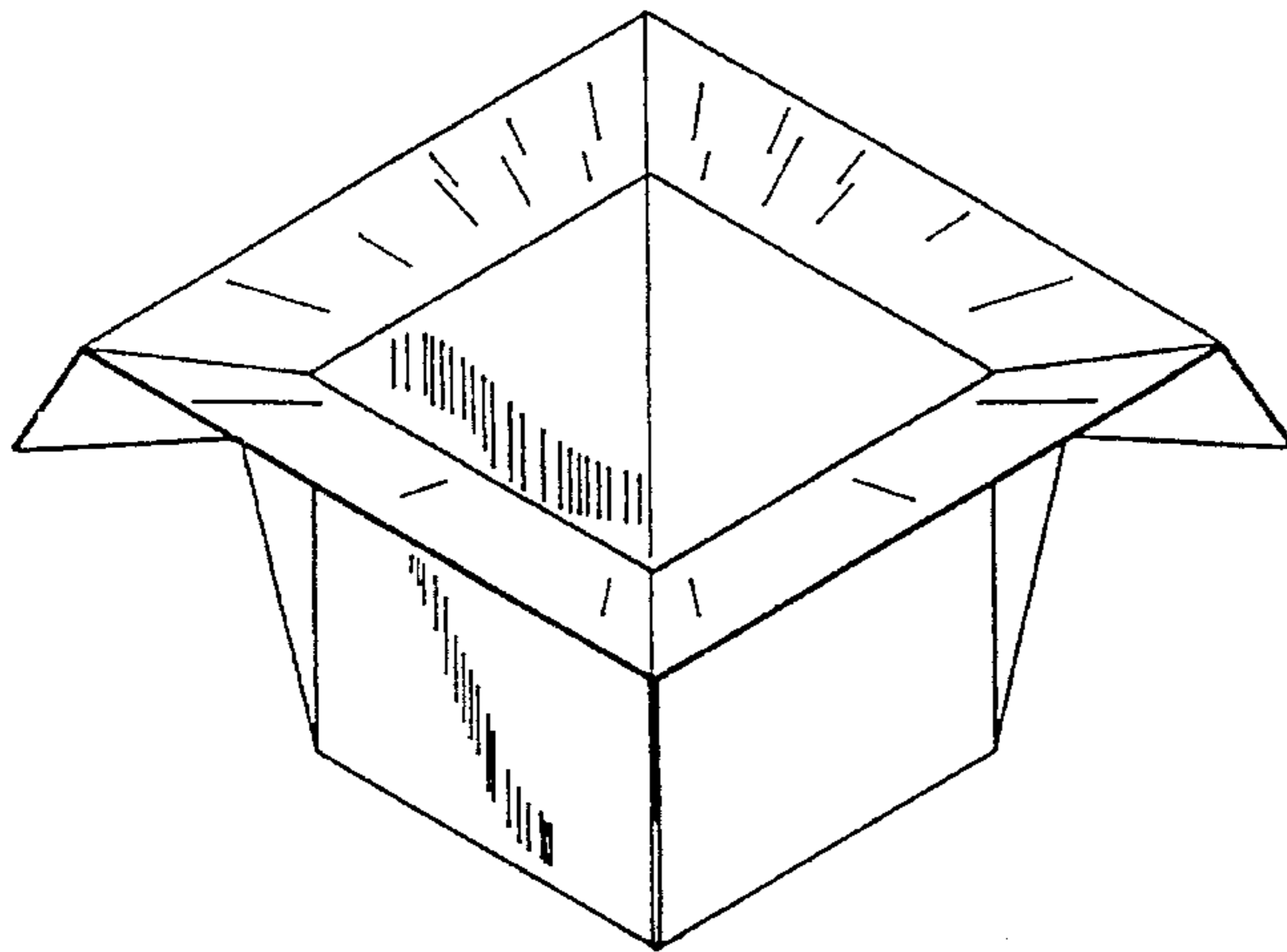

FIG. 34

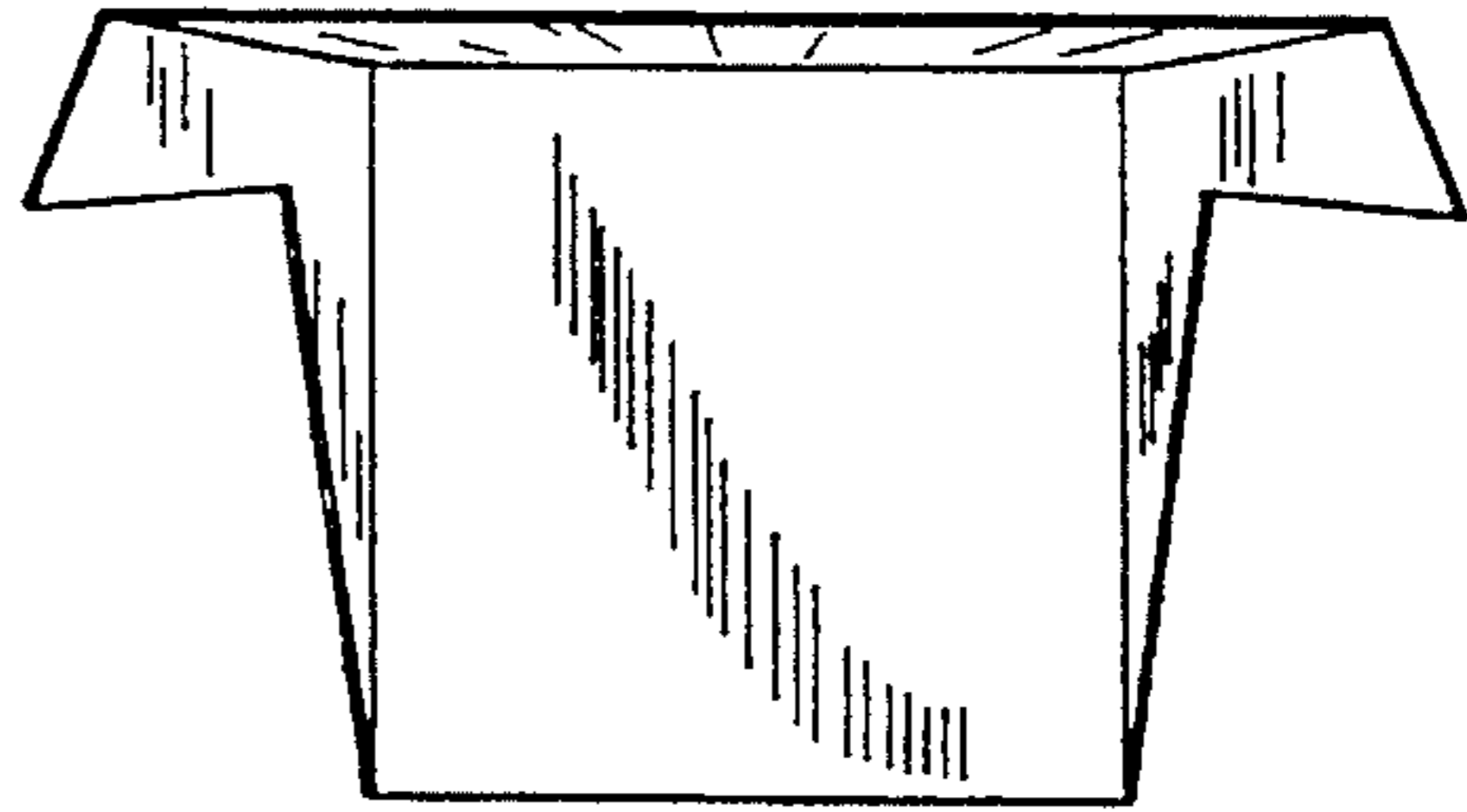

FIG. 35

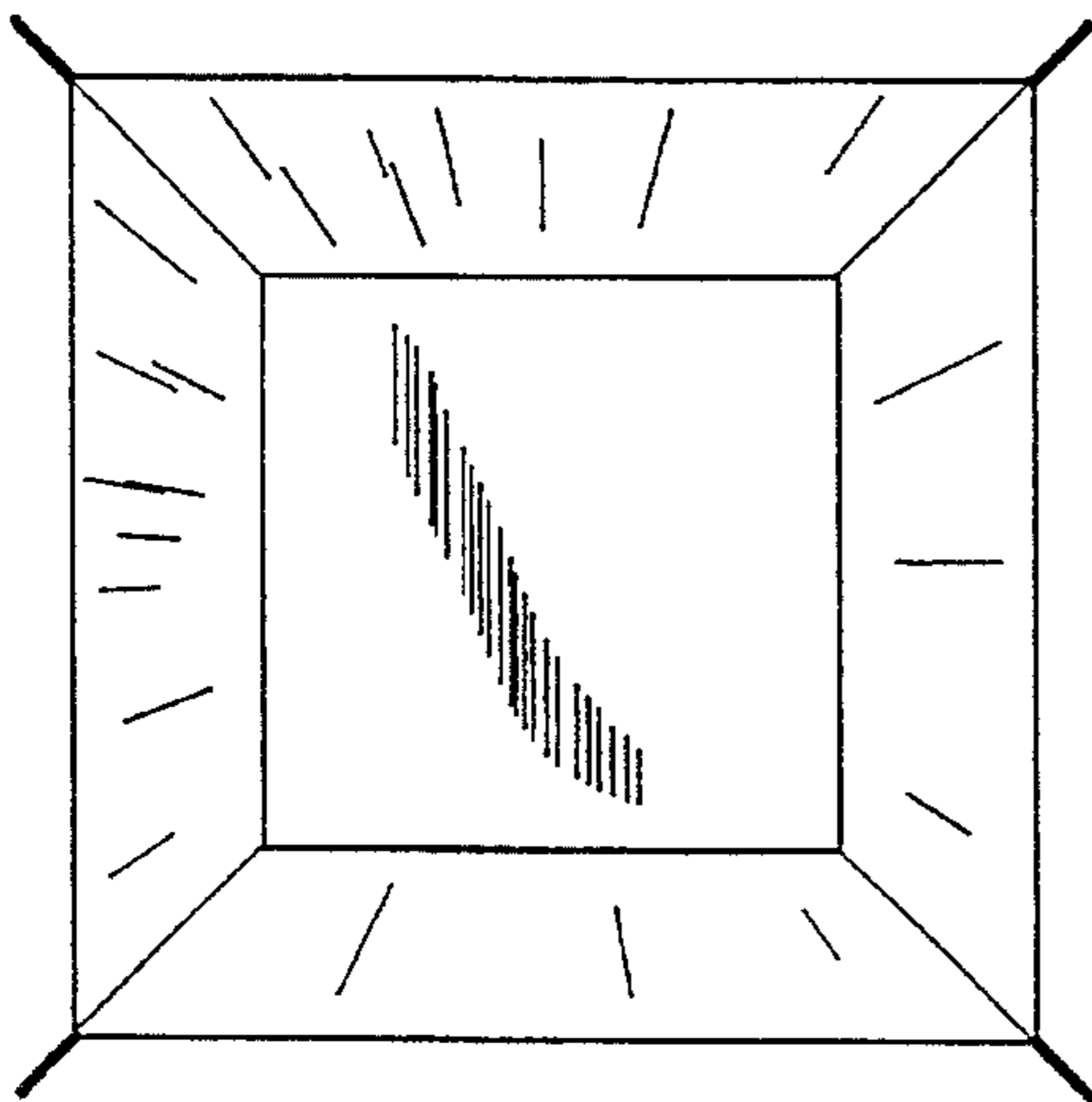

FIG. 36

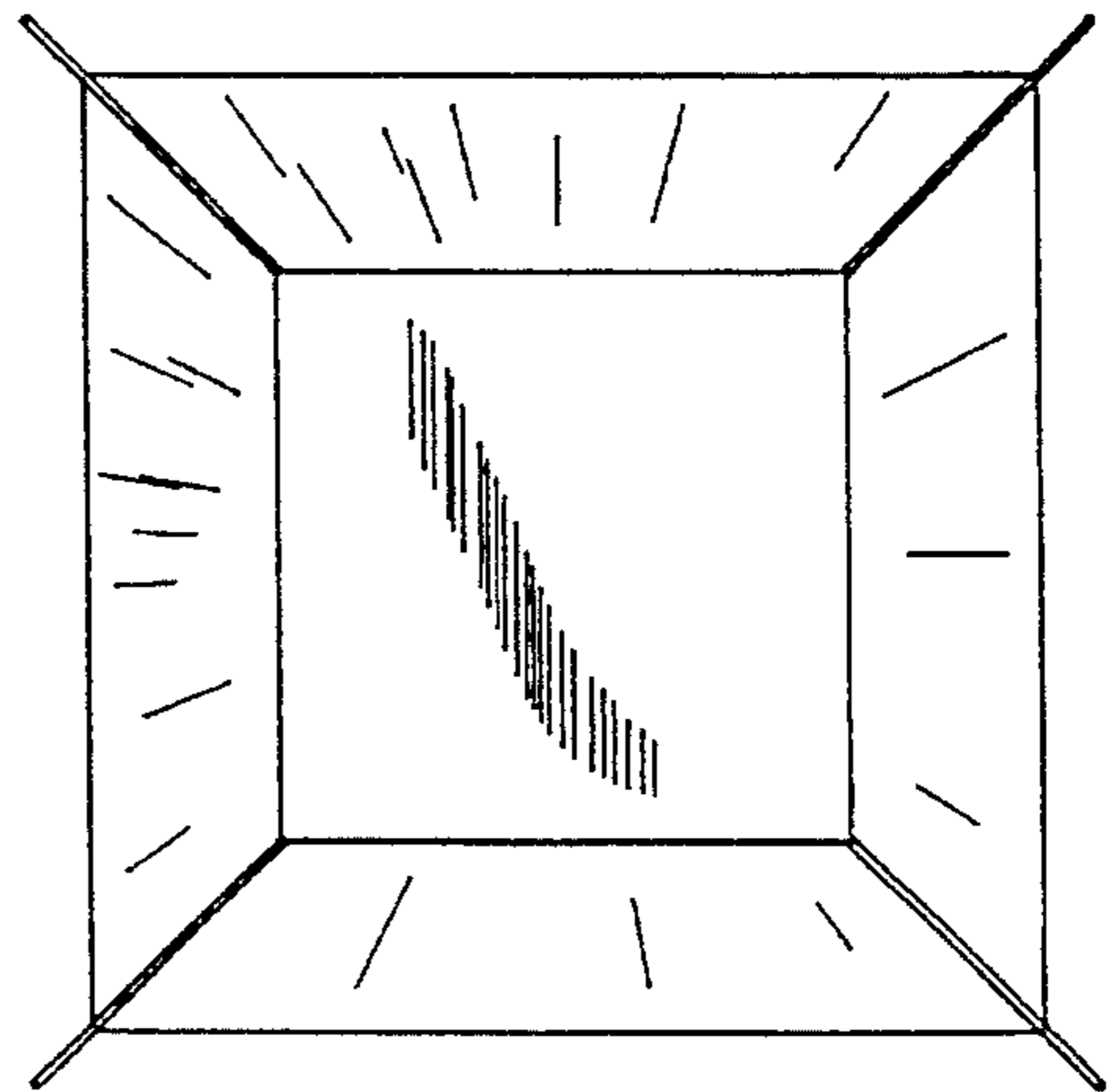

FIG. 37

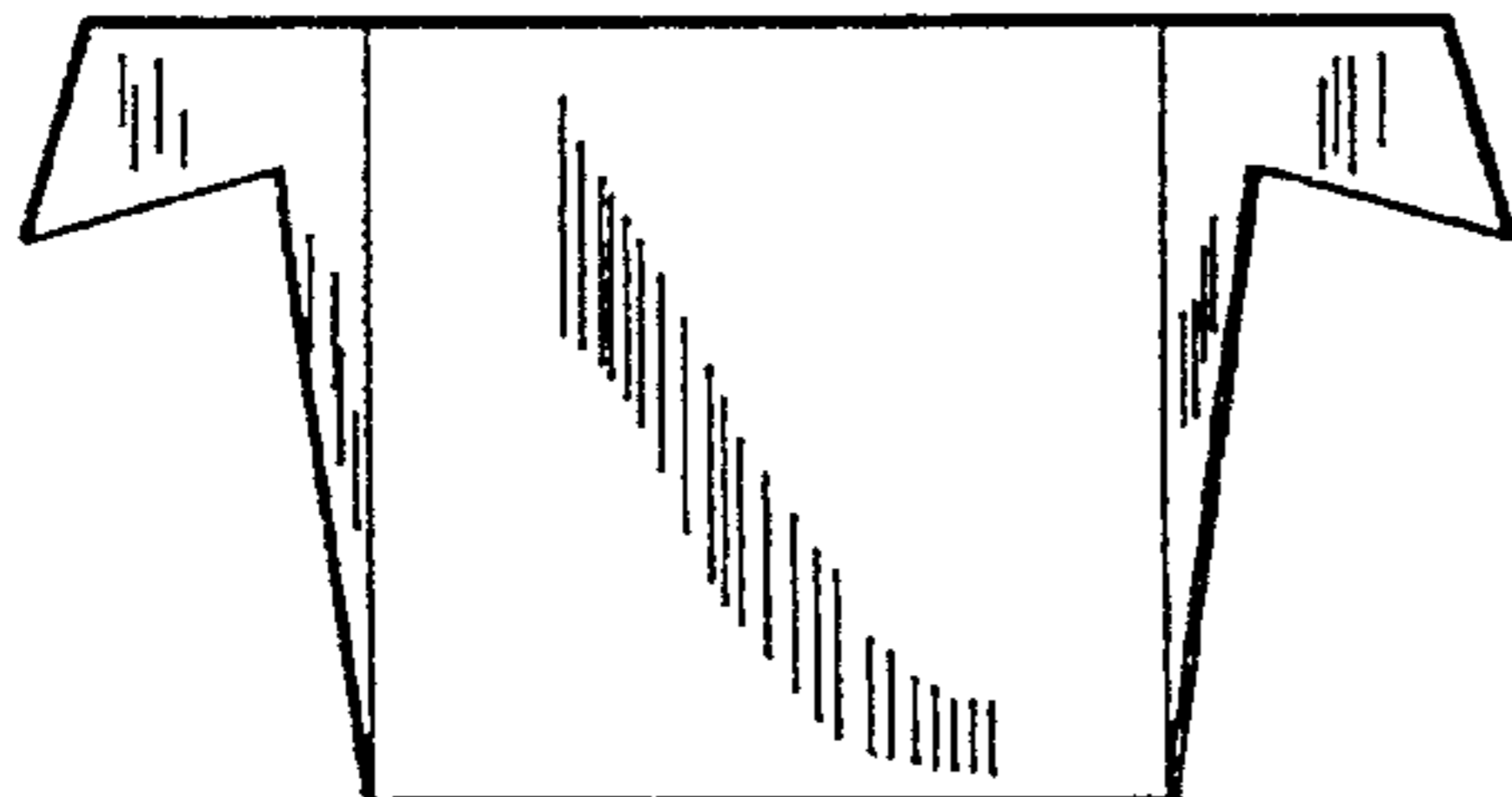

FIG. 38

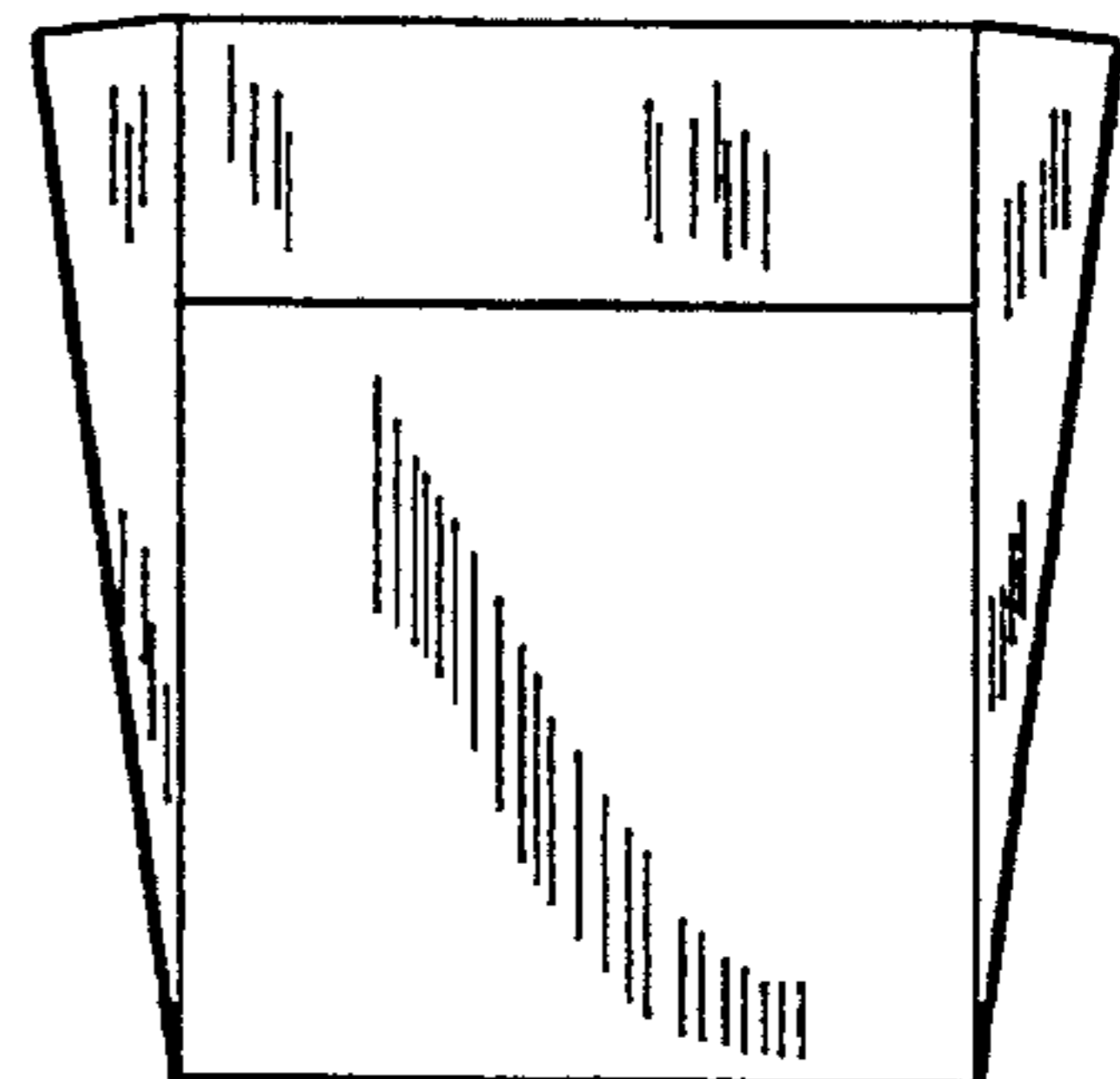

FIG. 39

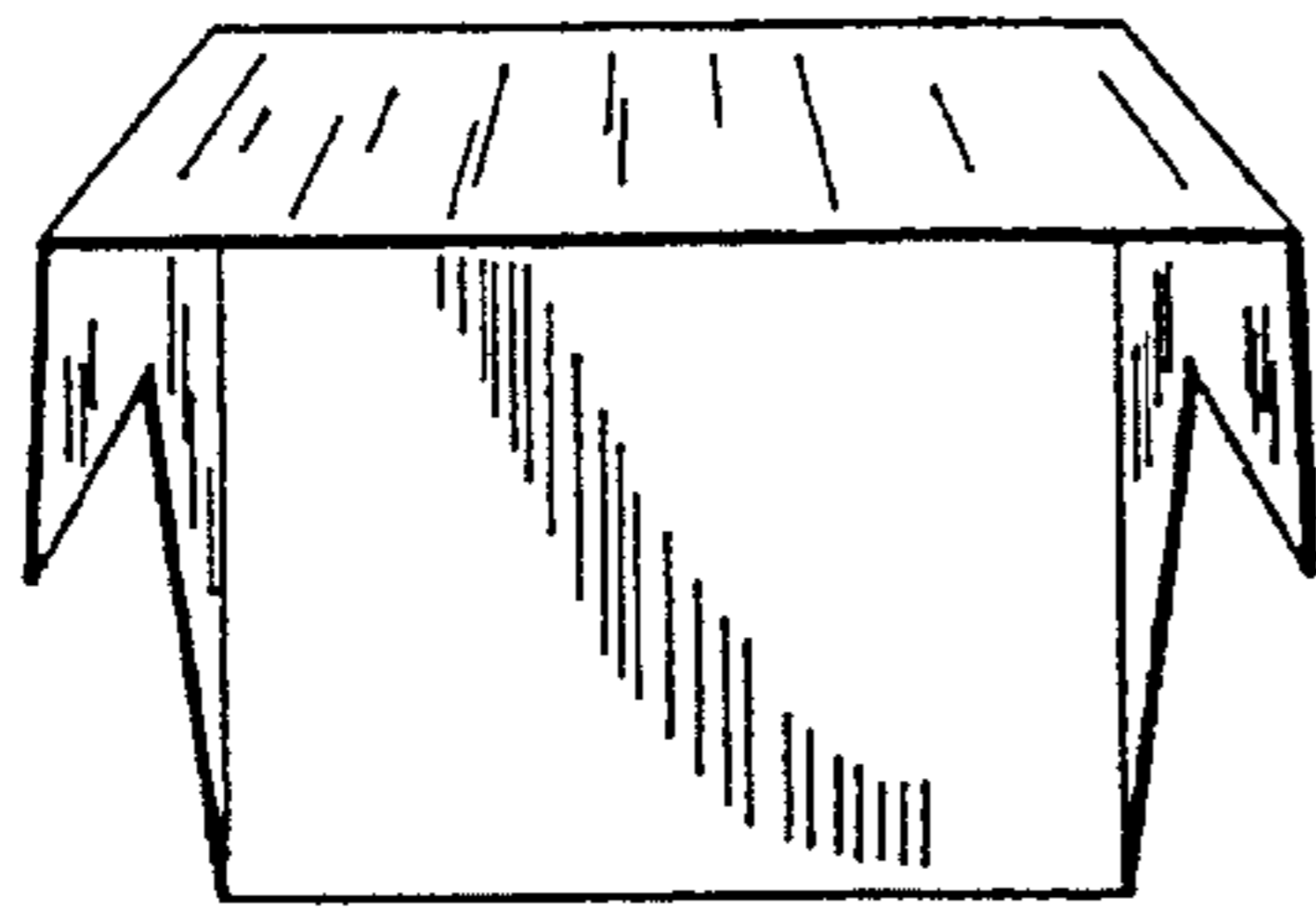

FIG. 40

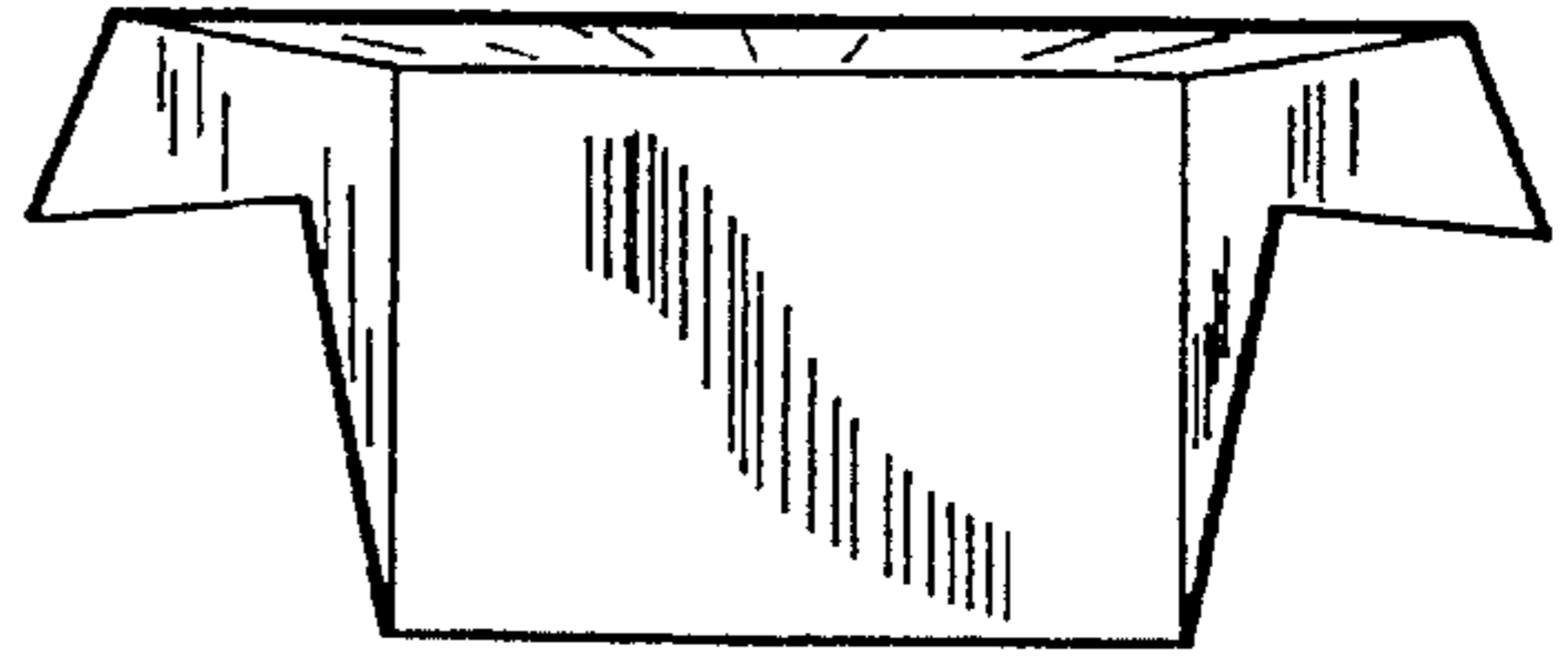

FIG. 41

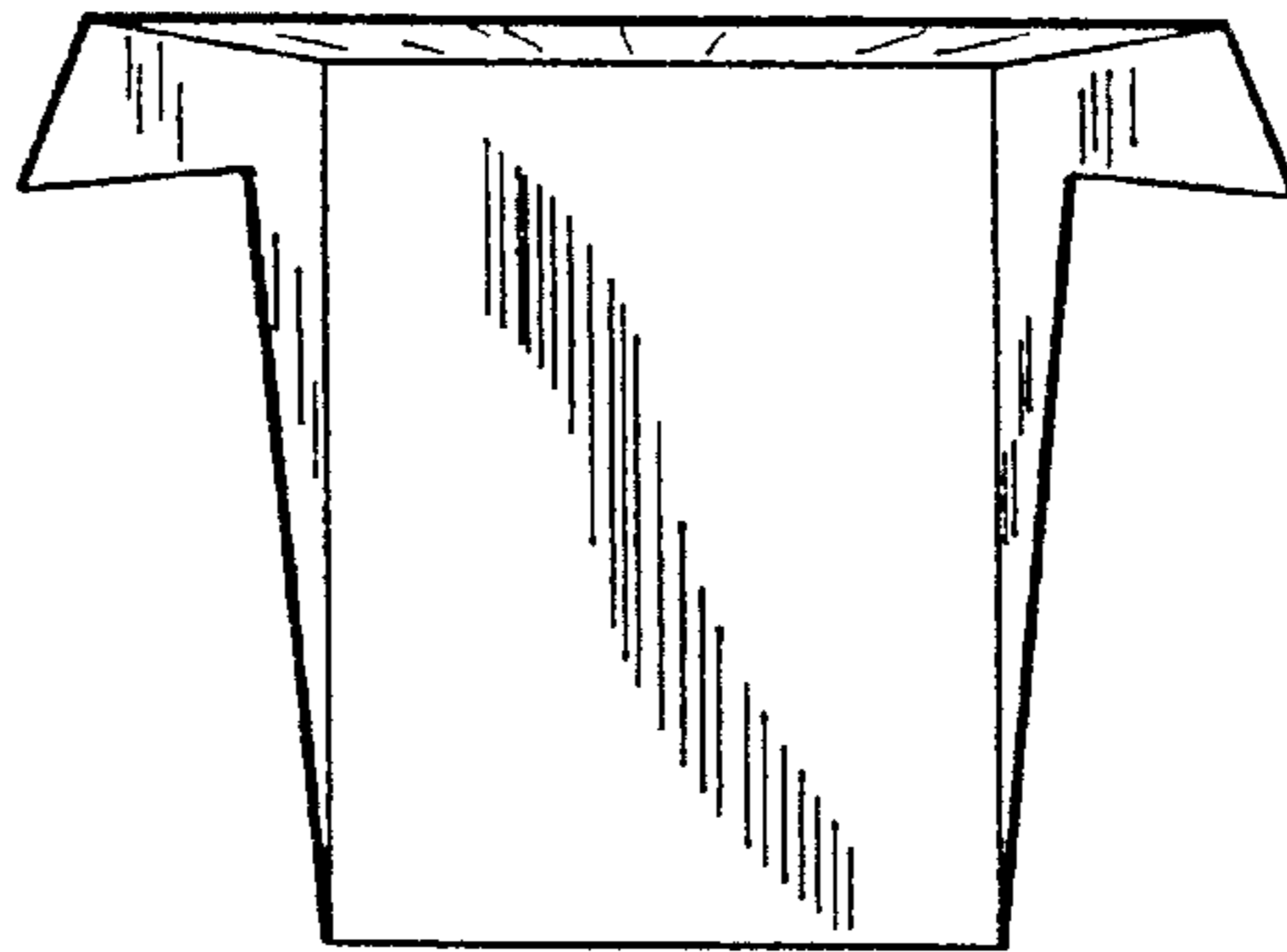

FIG. 42

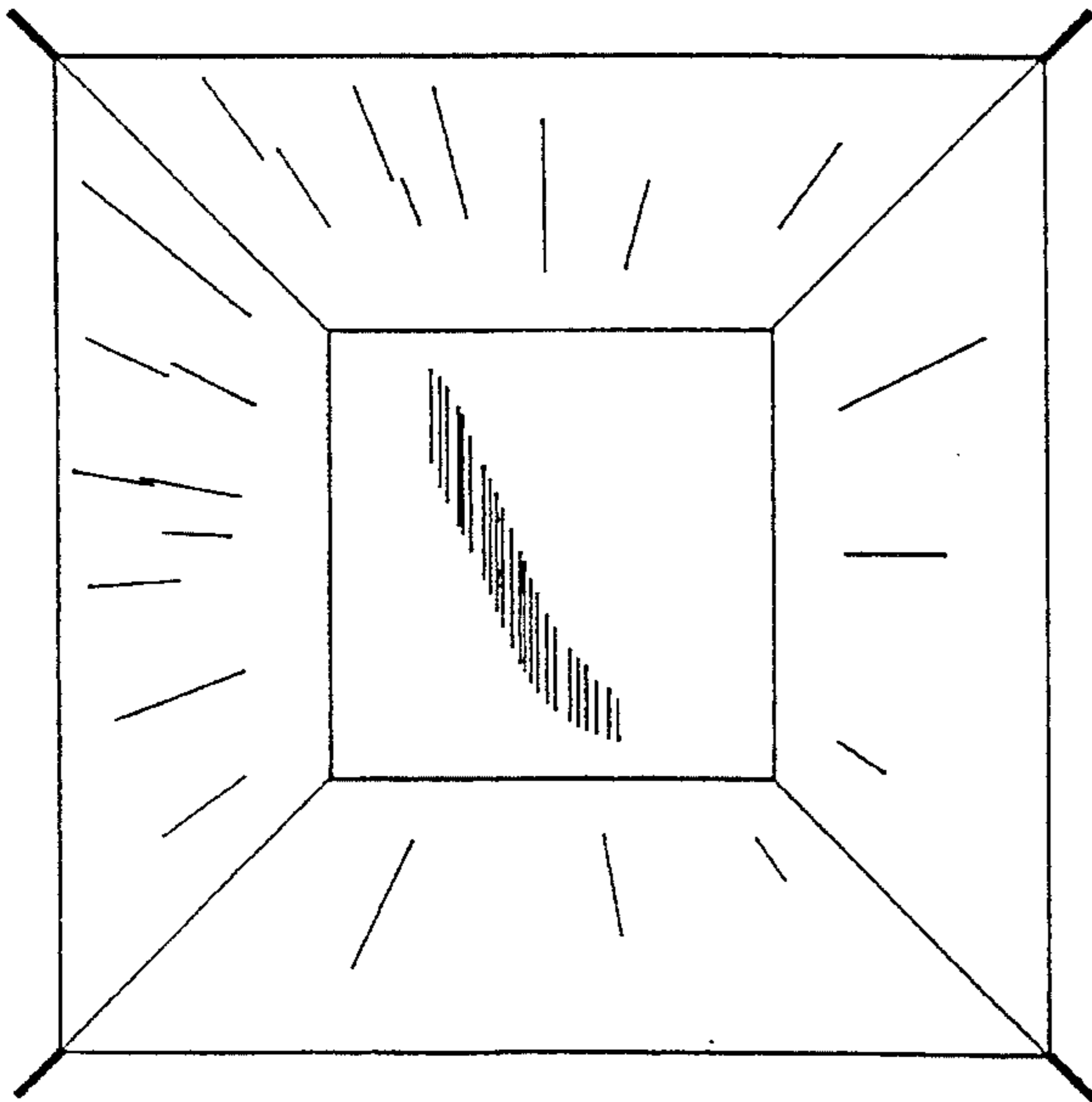

FIG. 43

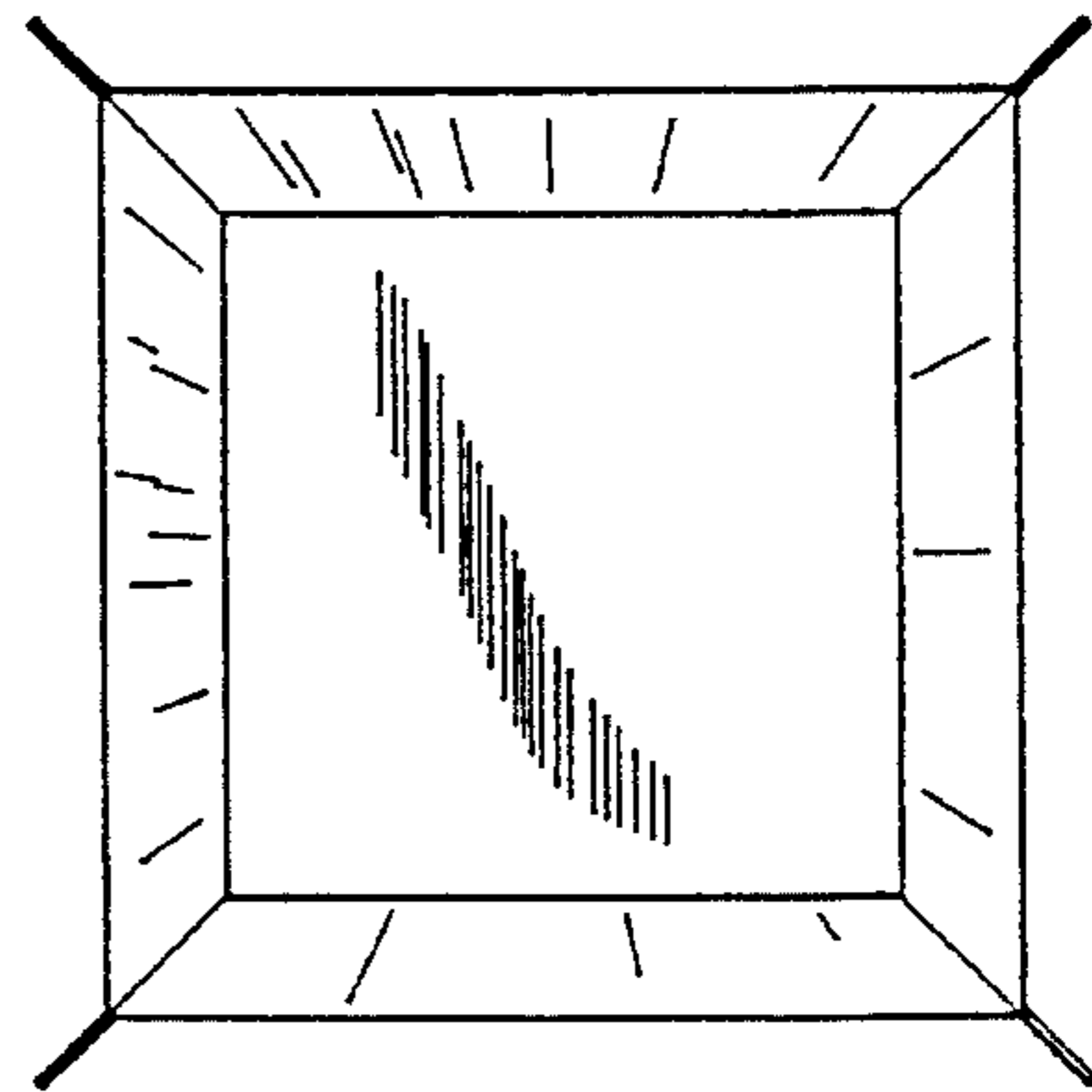

FIG. 44

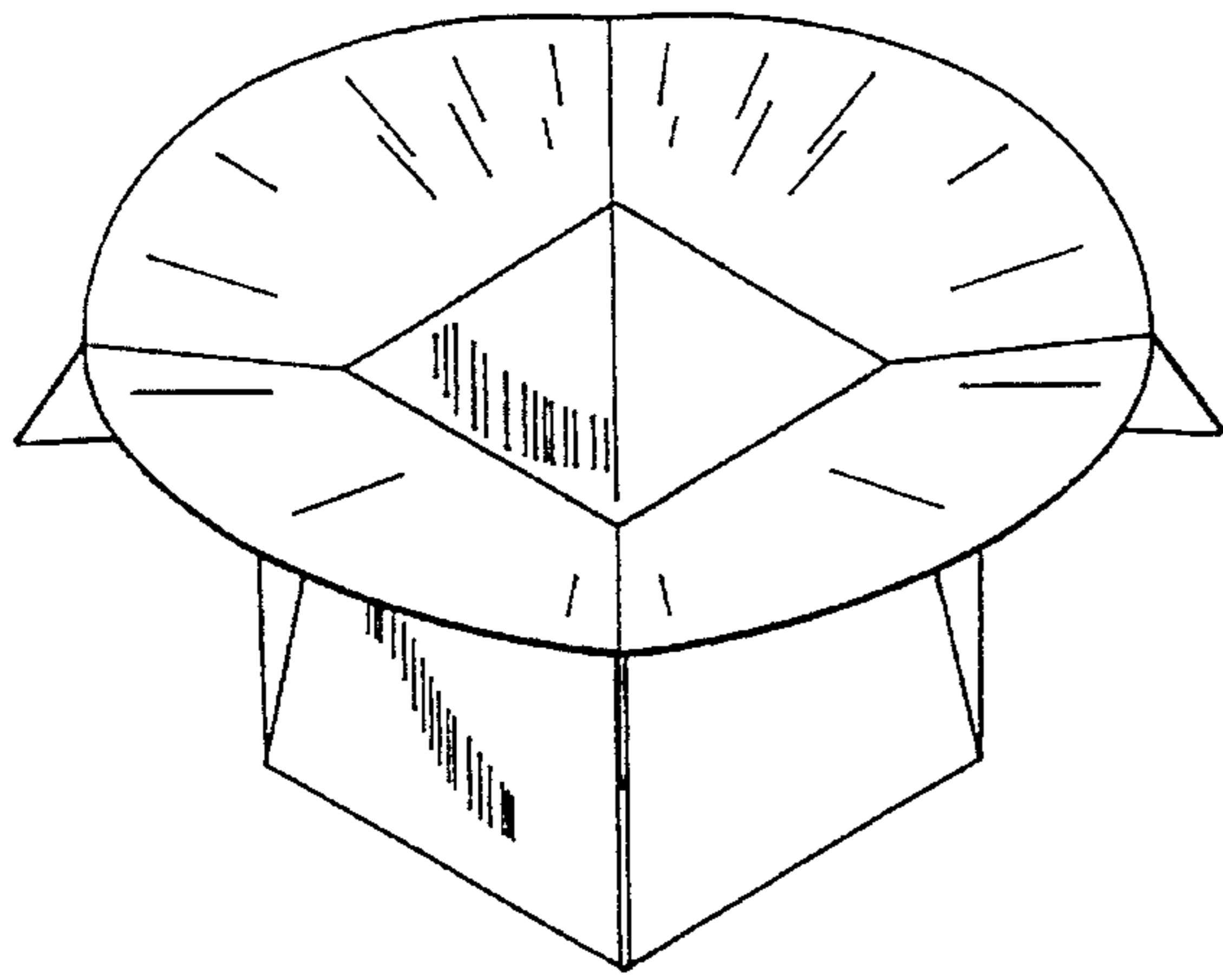

FIG. 45

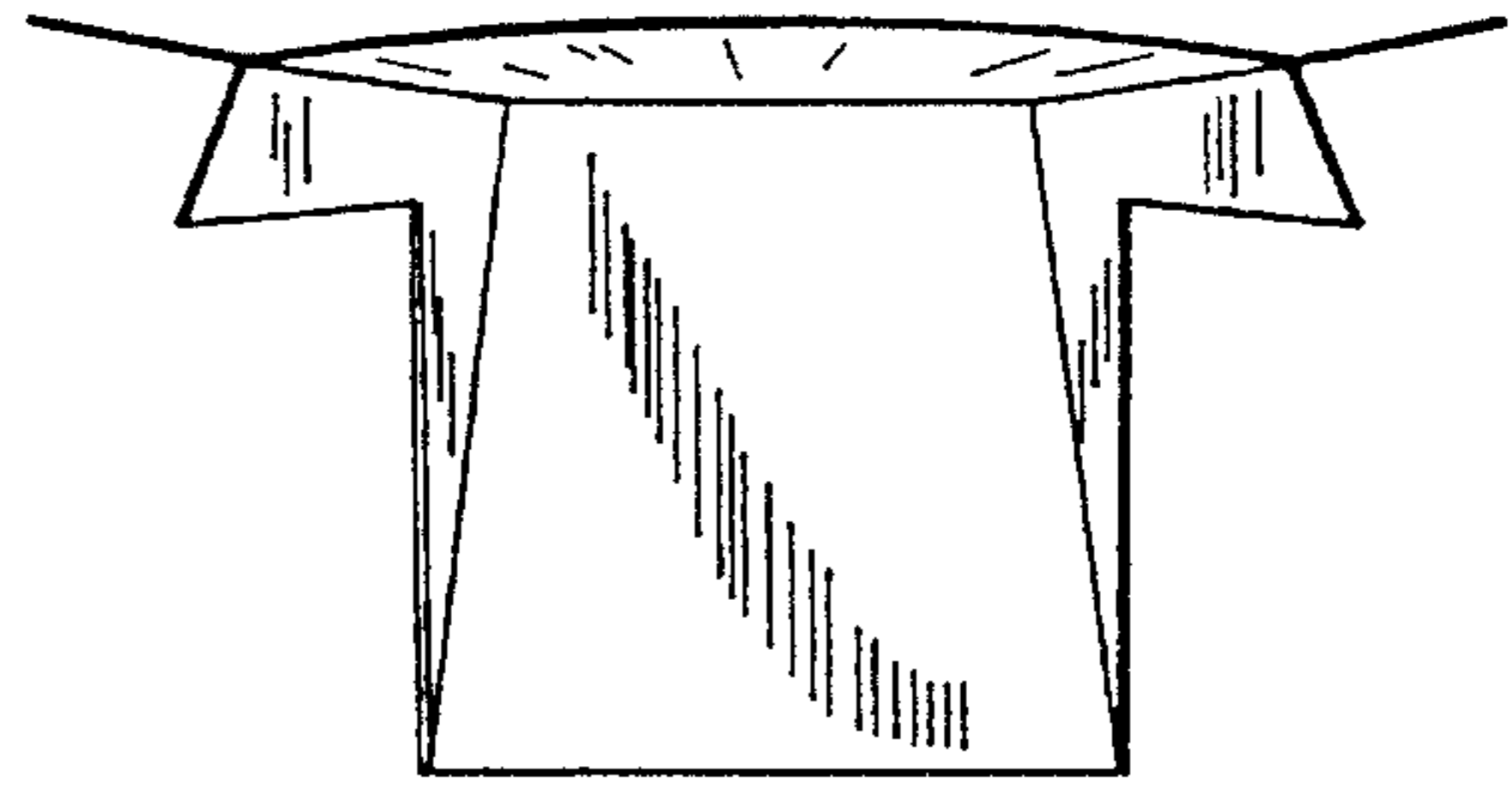

FIG. 46

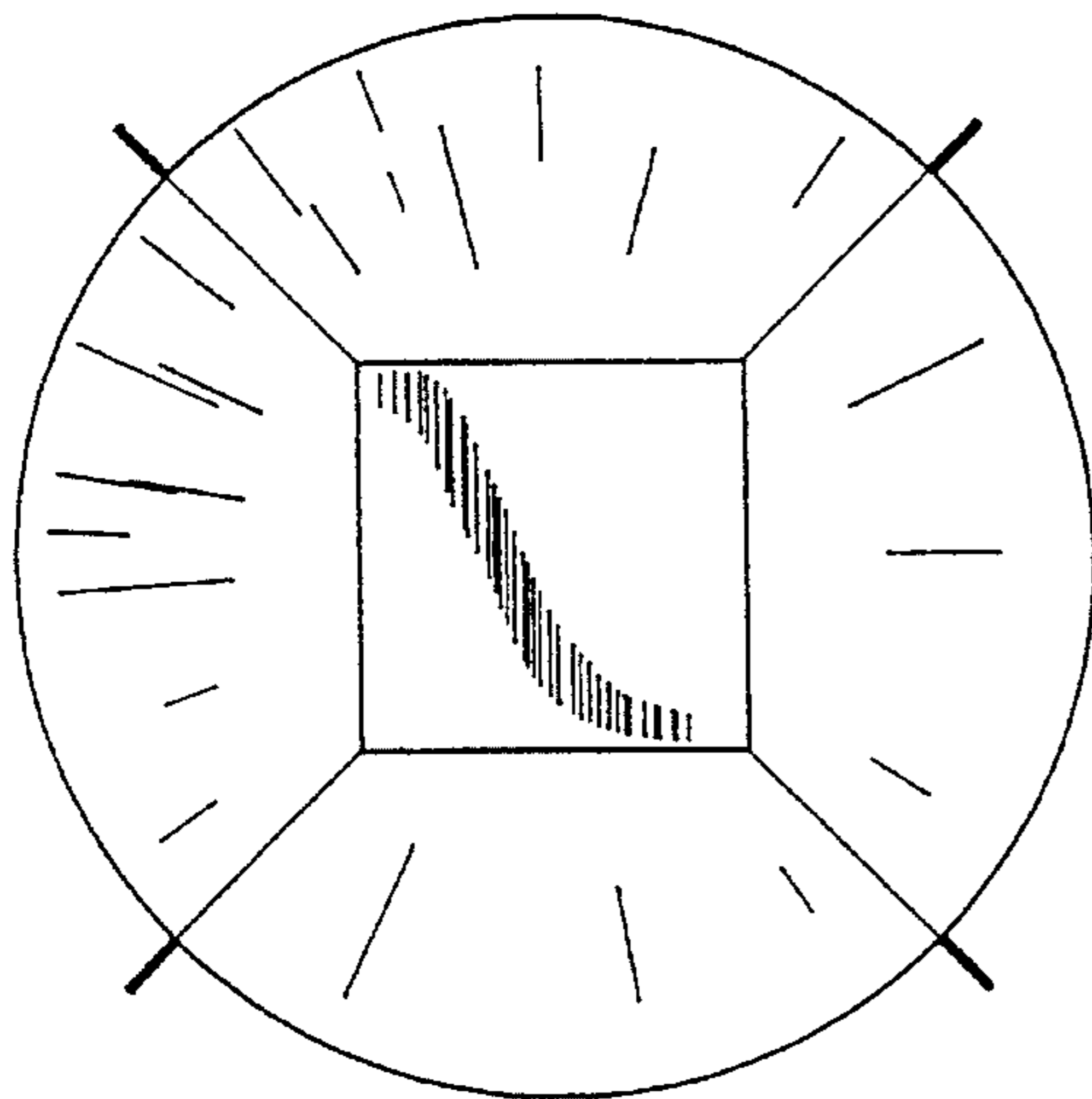

FIG. 47

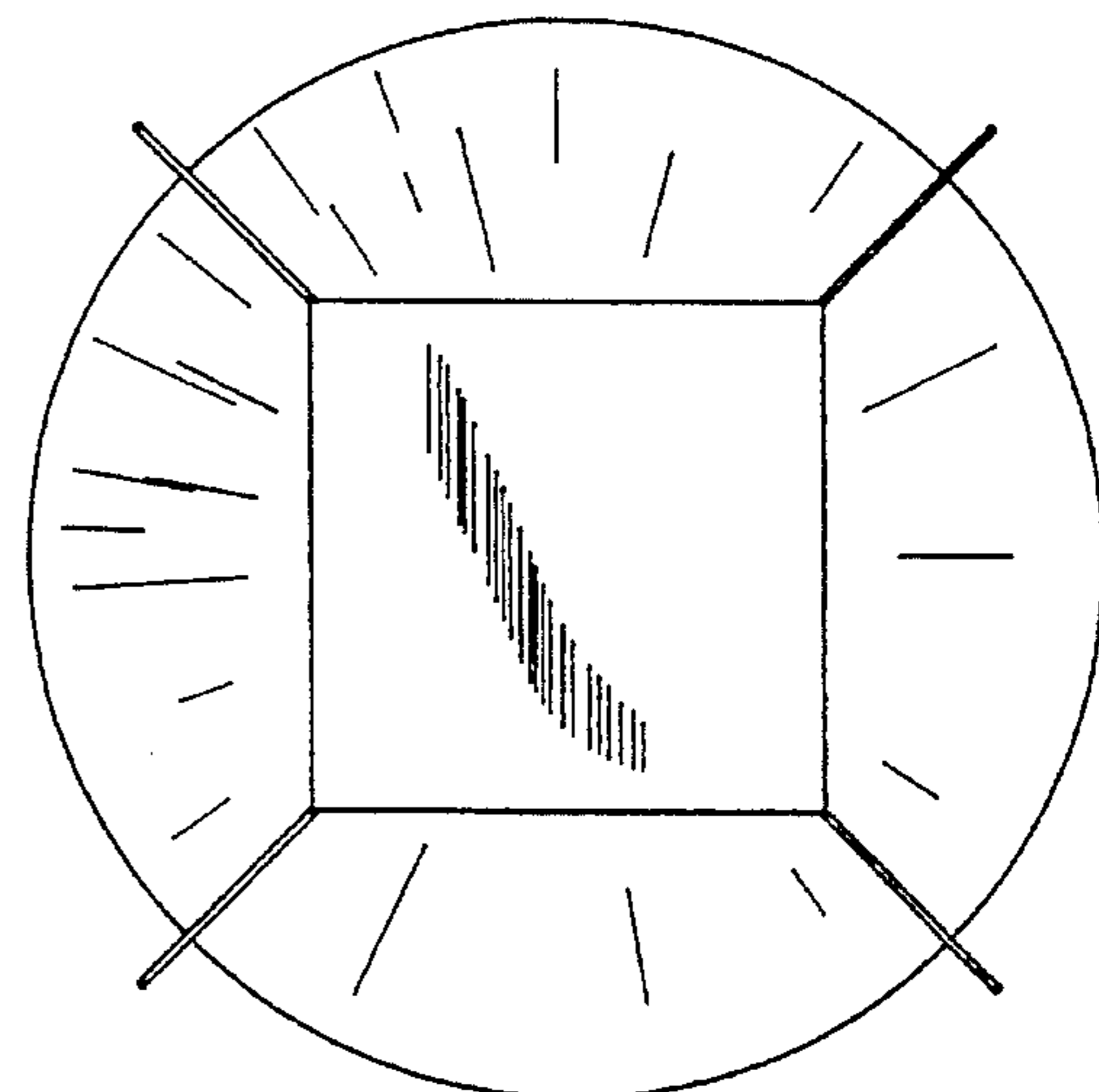

FIG. 48

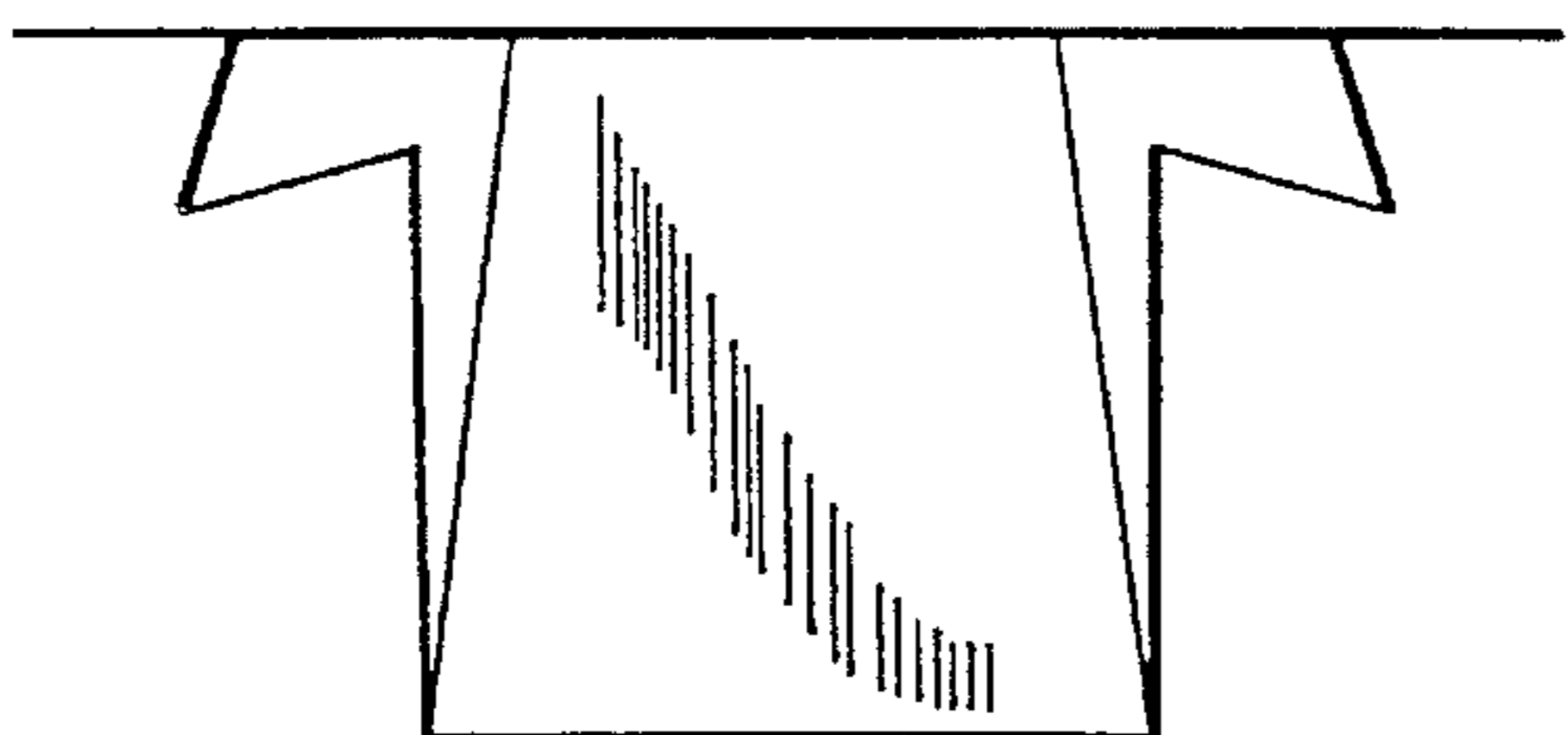

FIG. 49

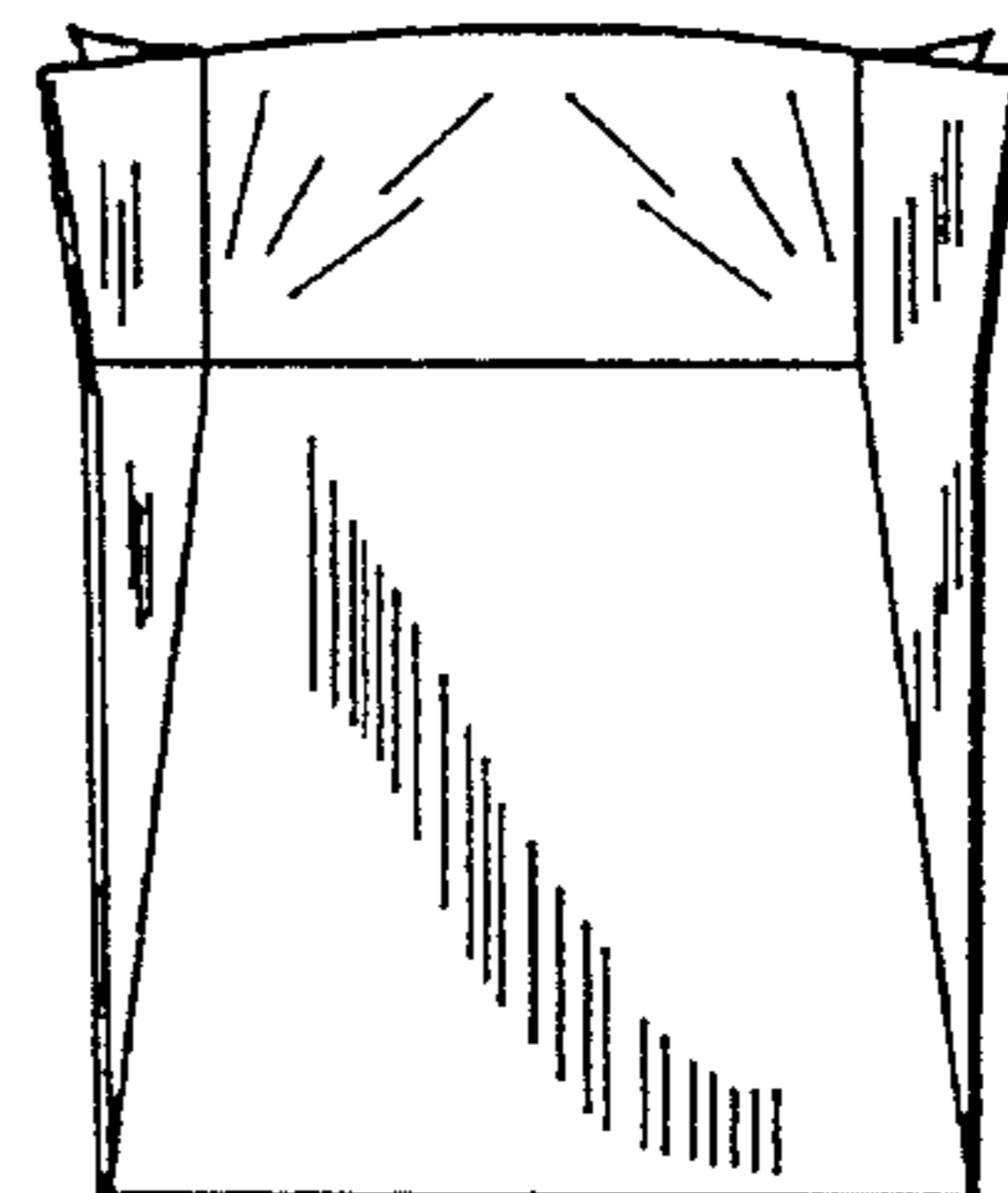

FIG. 50

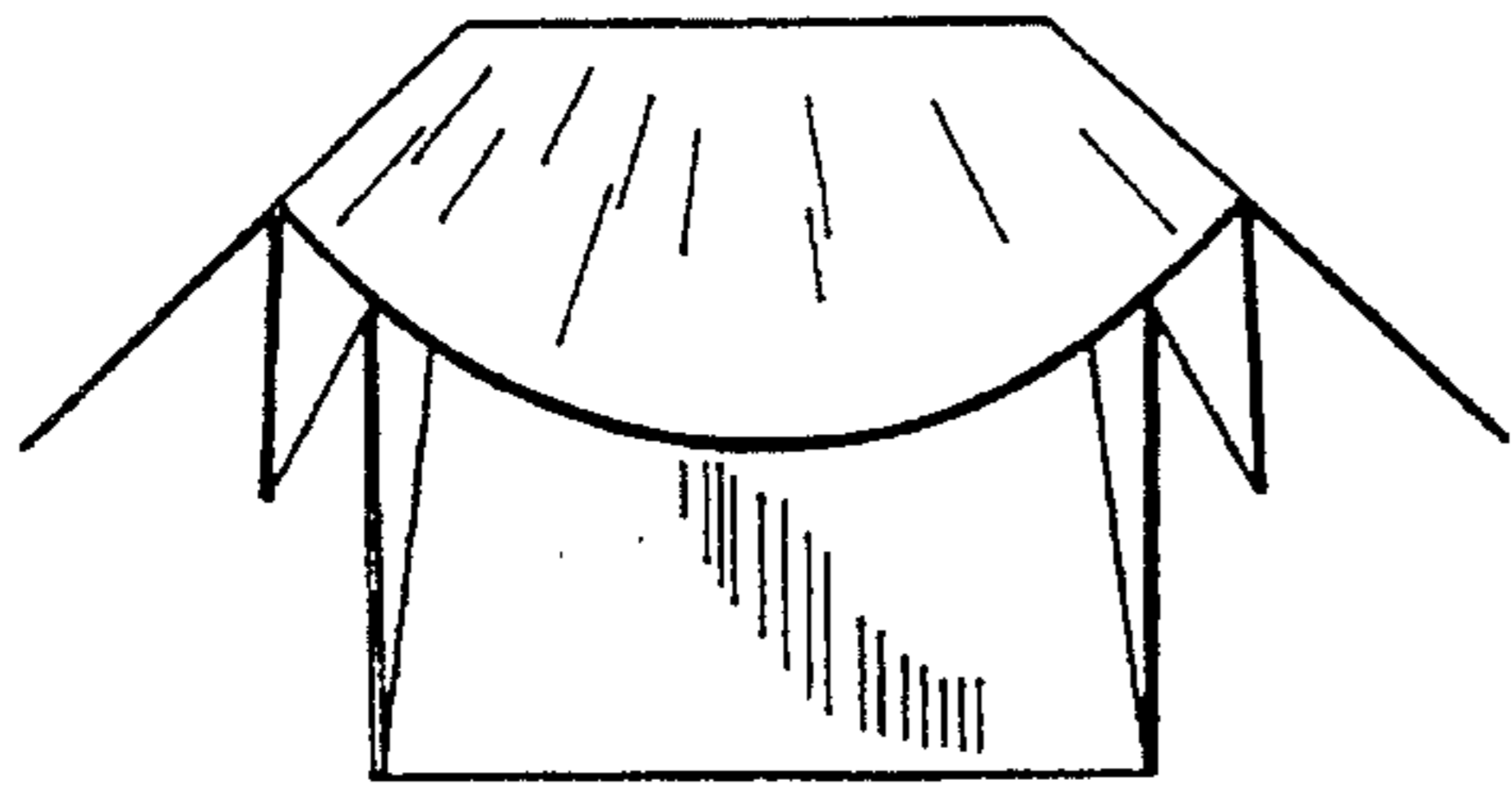

FIG. 51

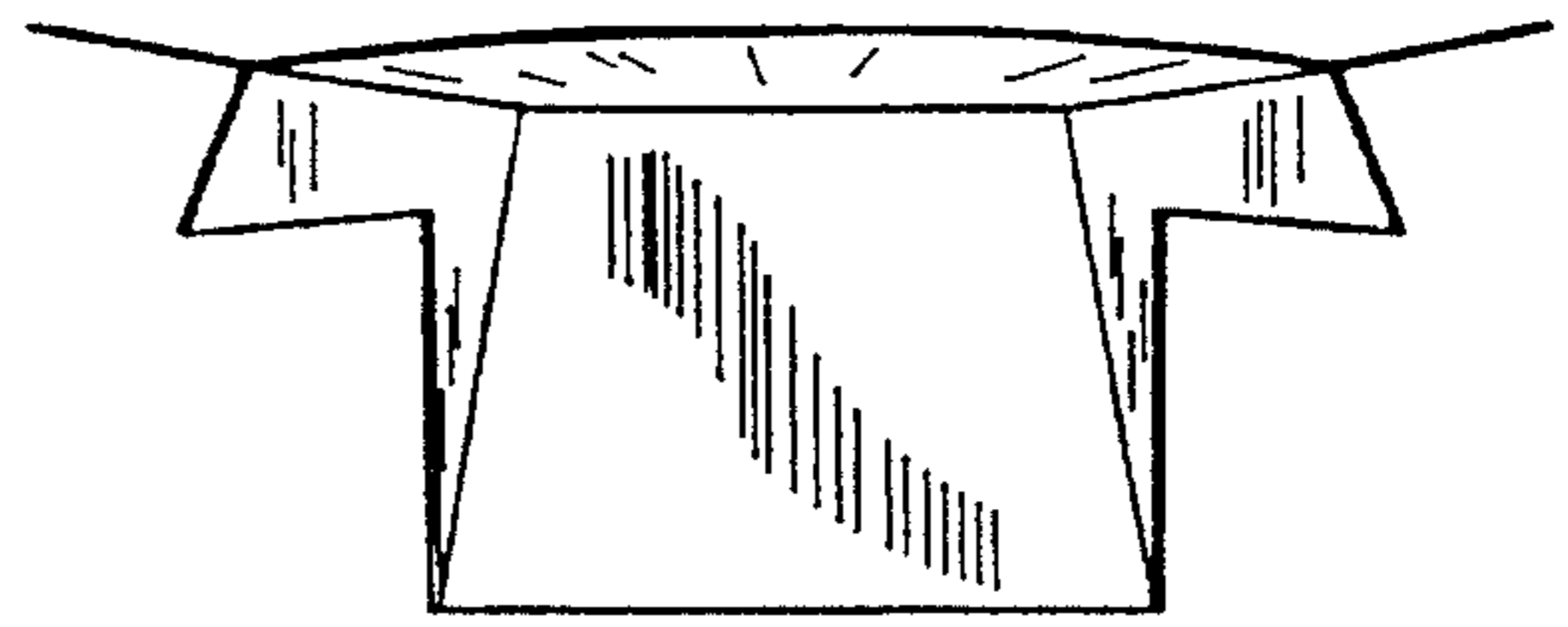

FIG. 52

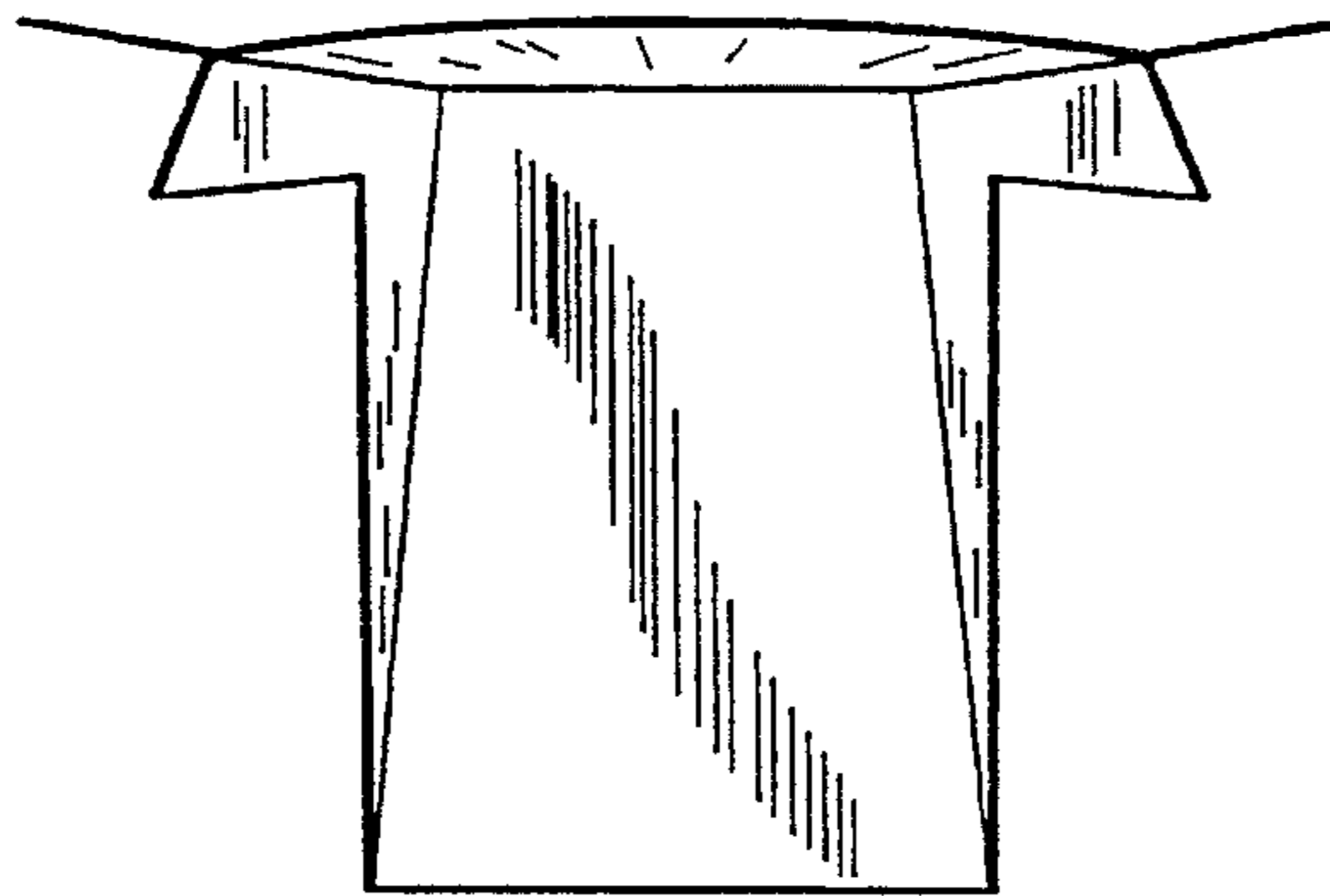

FIG. 53

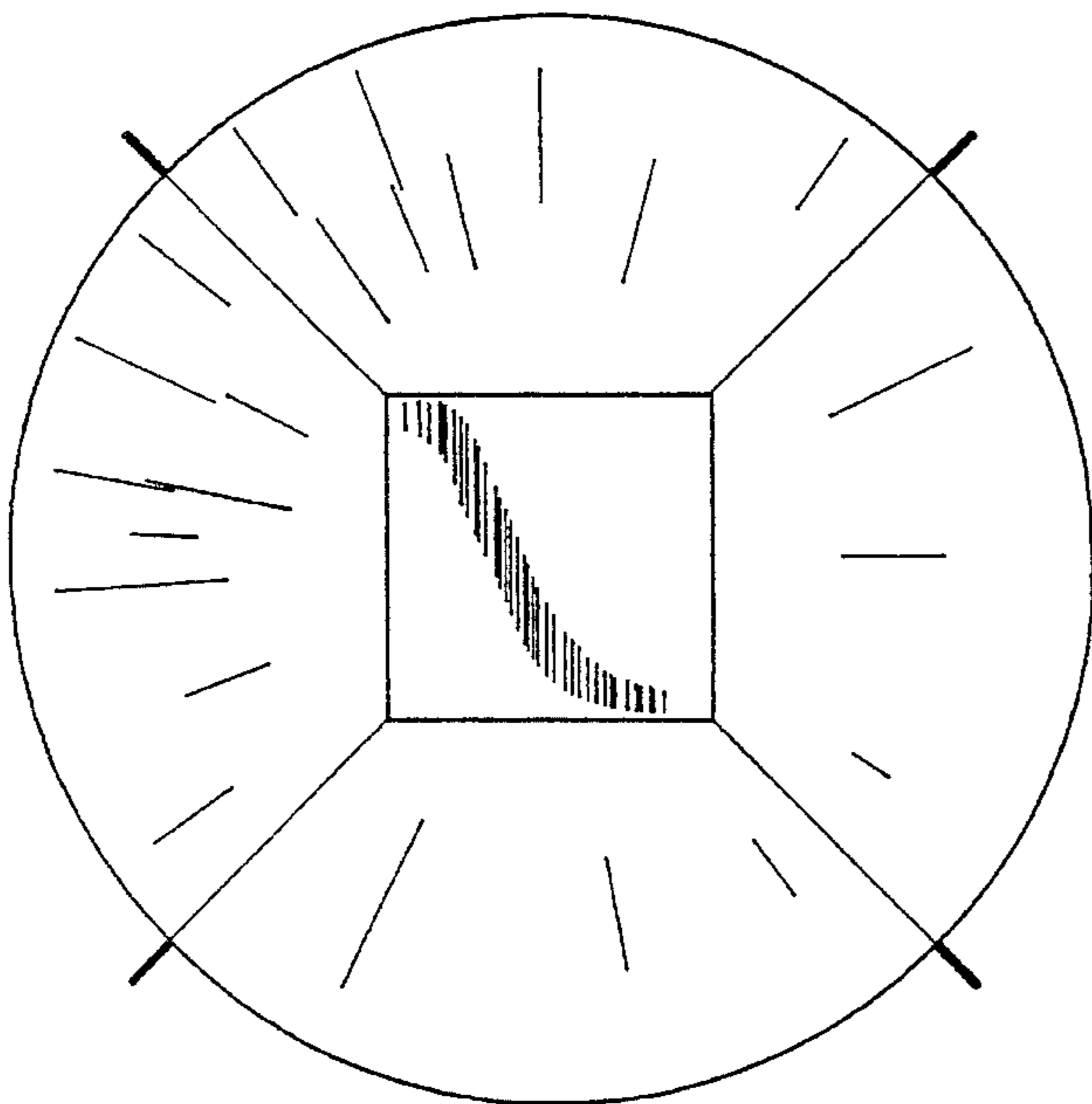

FIG. 54

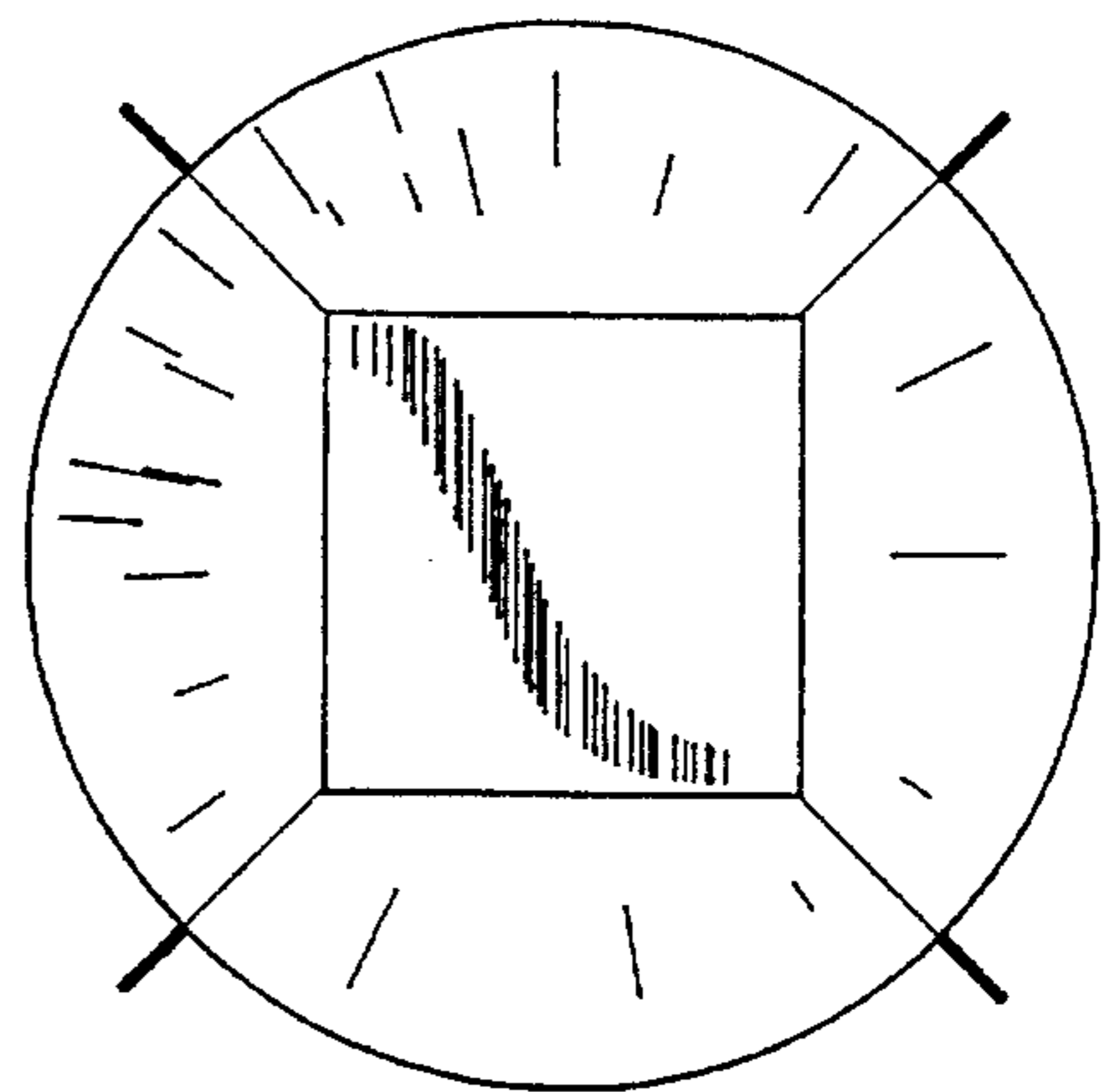

FIG. 55

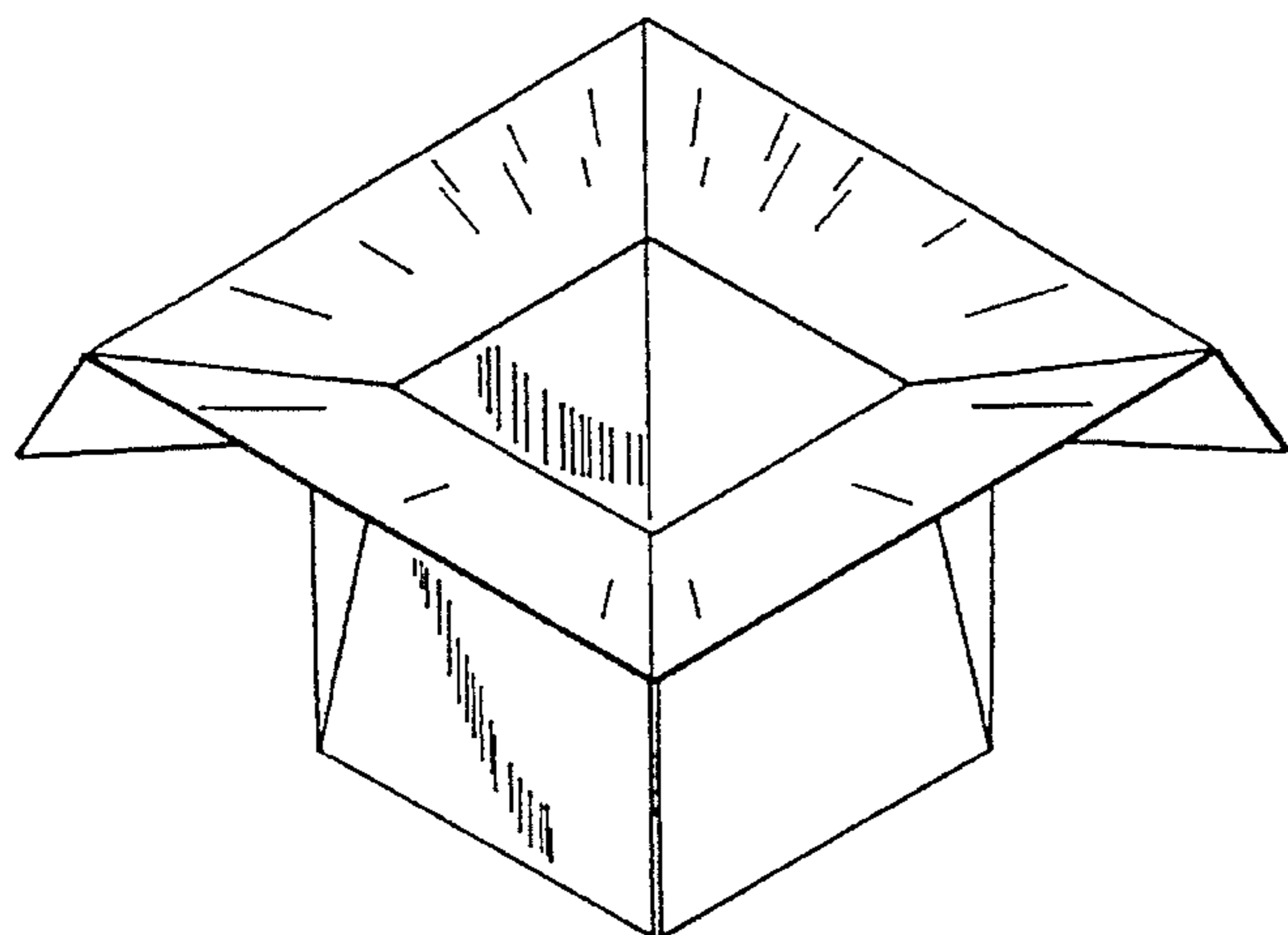

FIG. 56

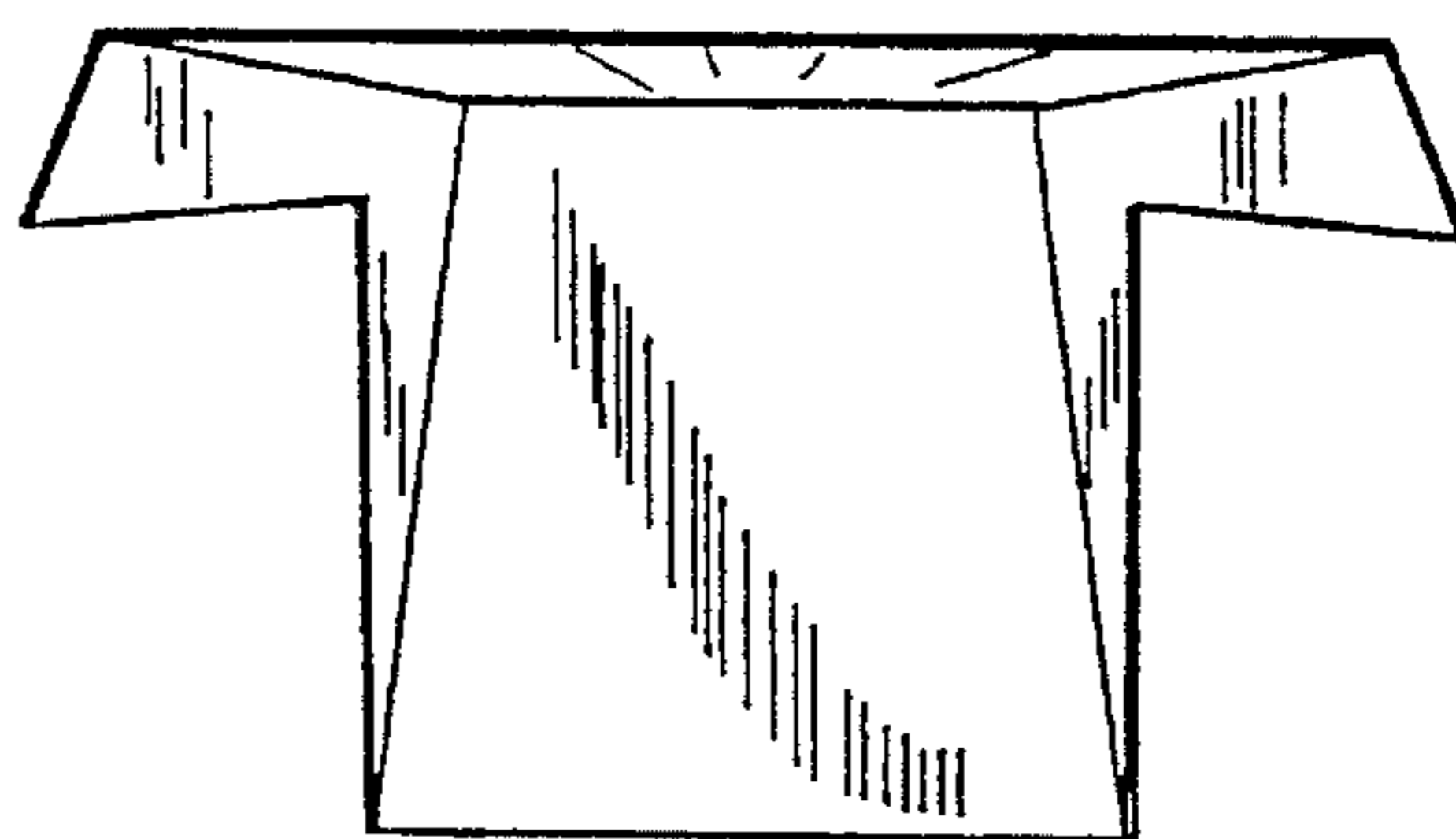

FIG. 57

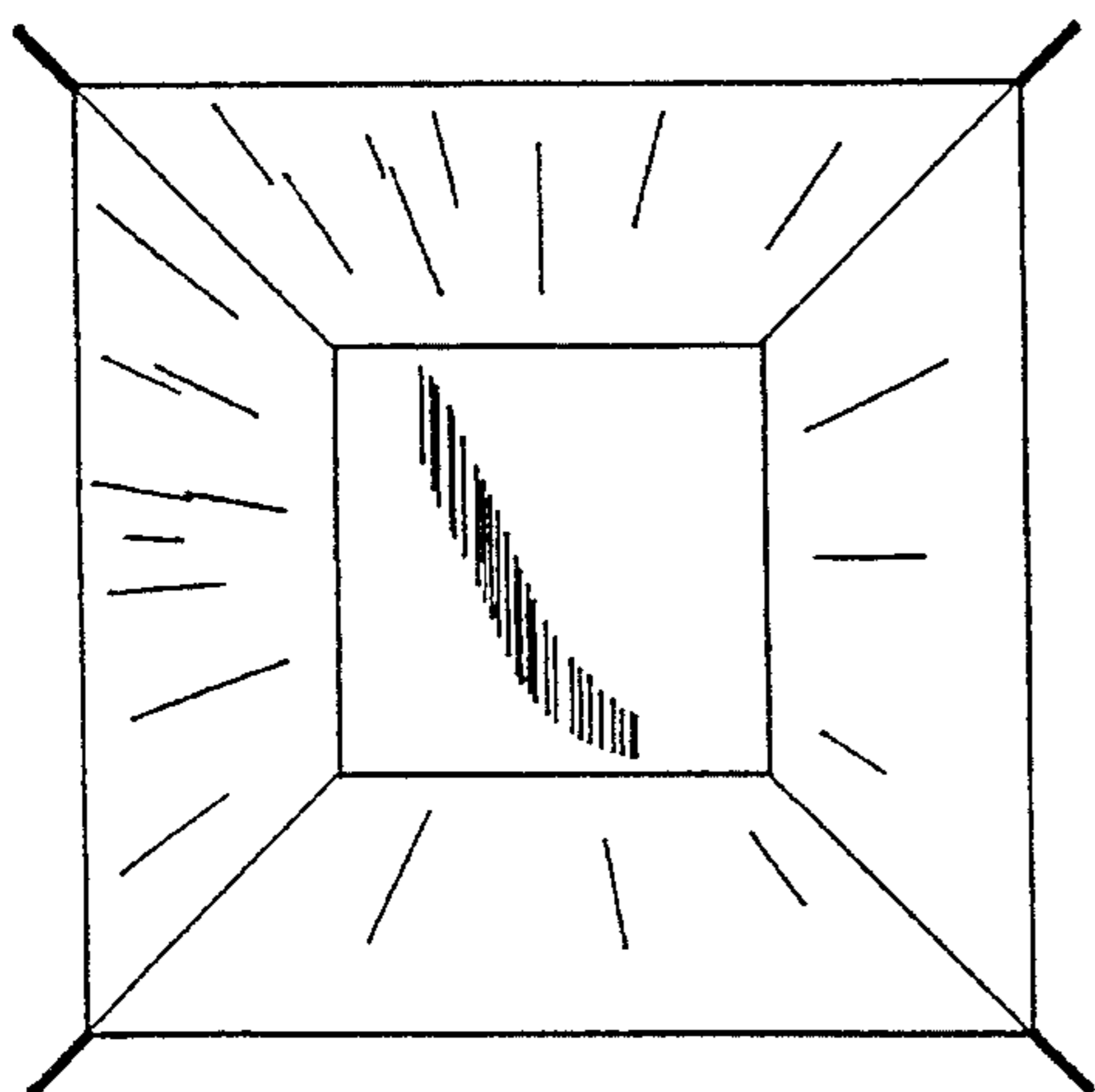

FIG. 58

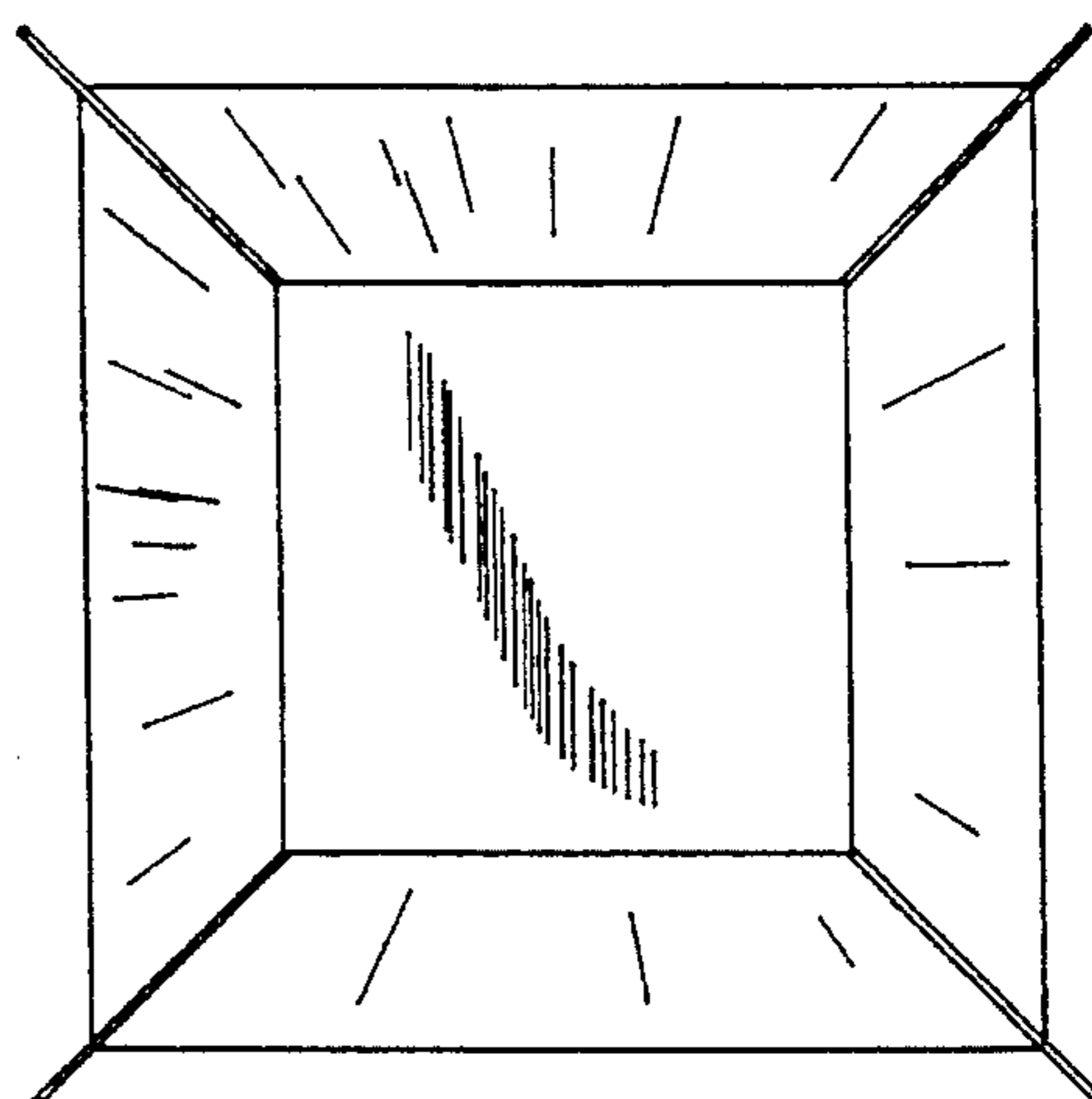

FIG. 59

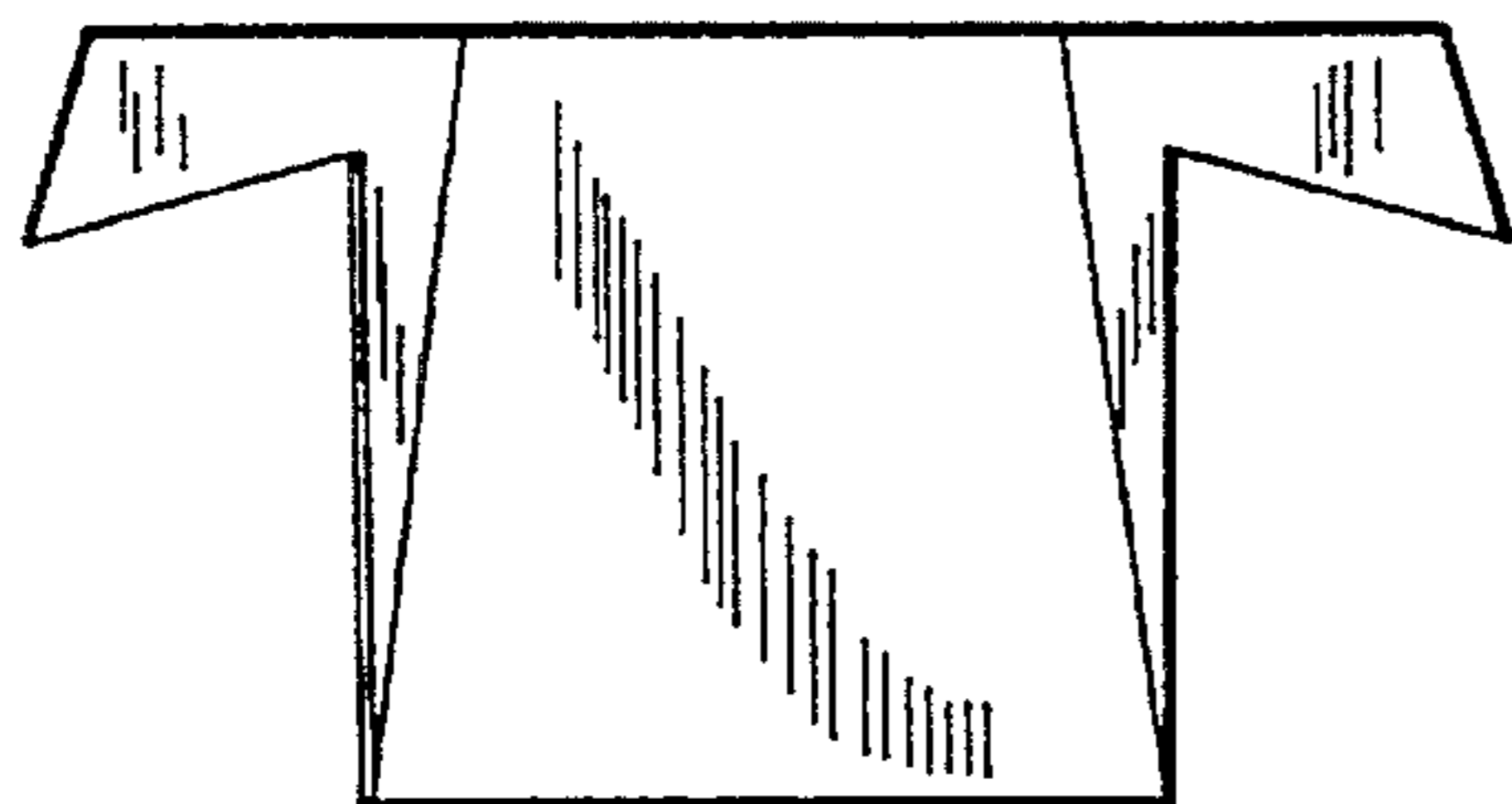

FIG. 60

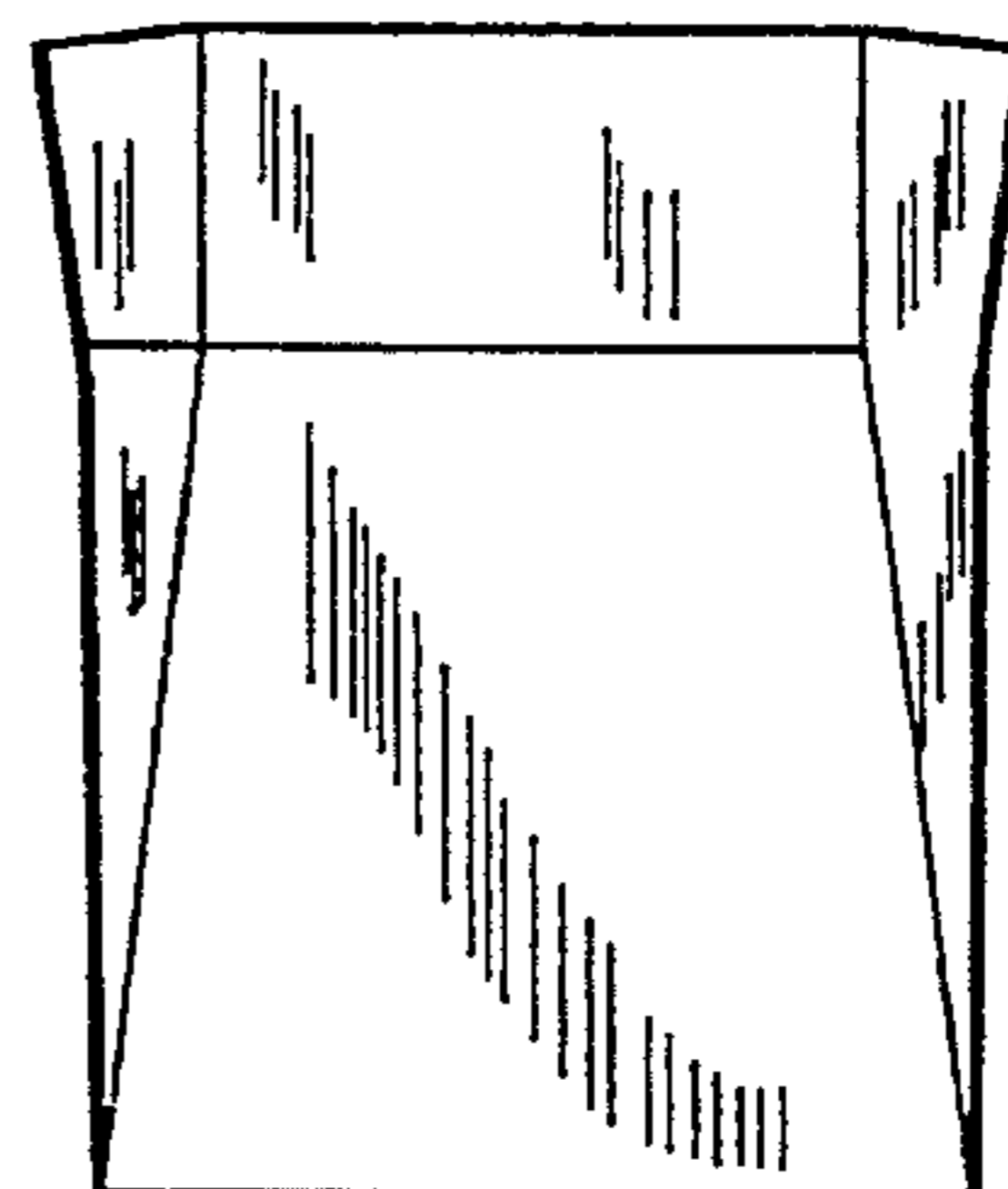

FIG. 61

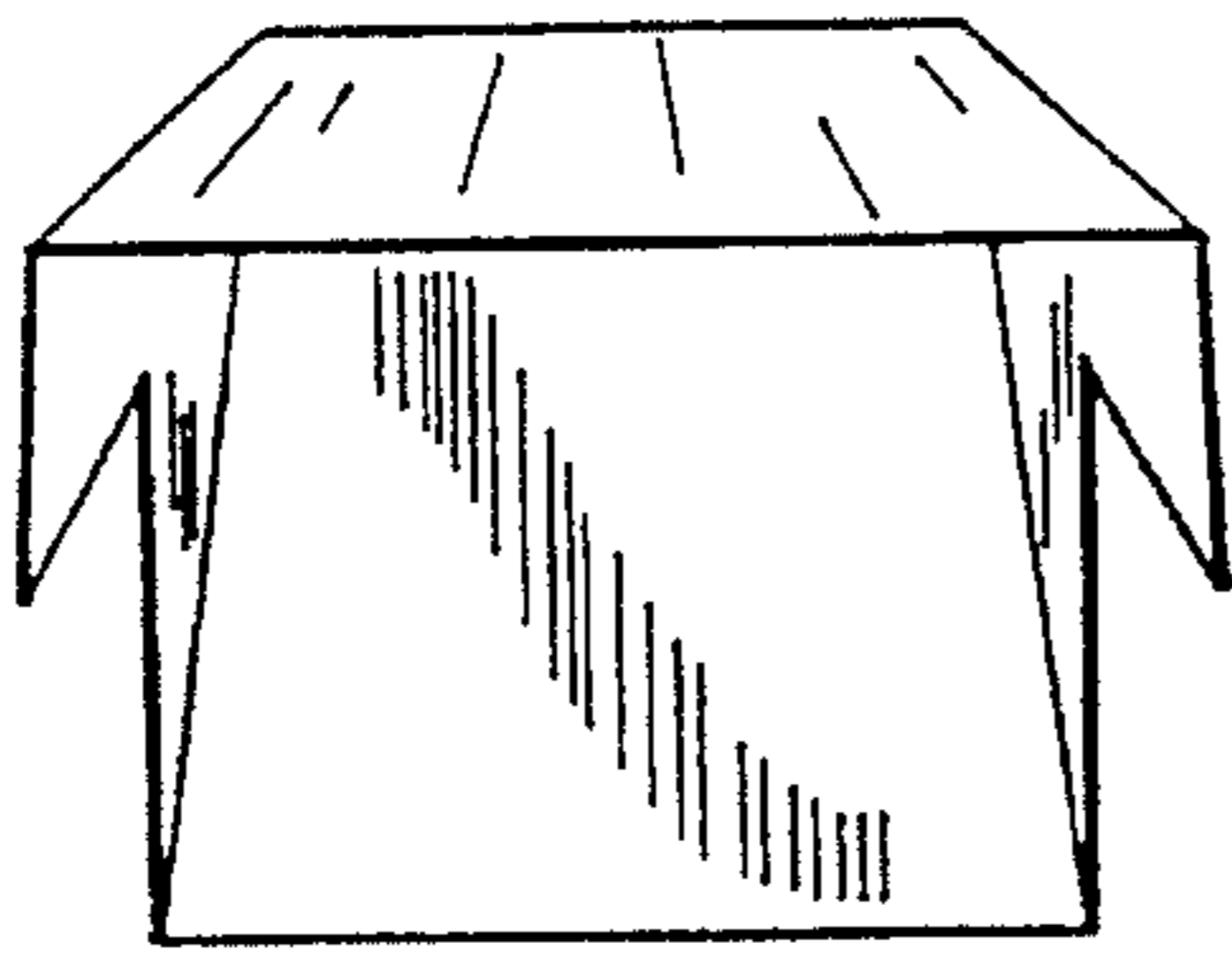

FIG. 52

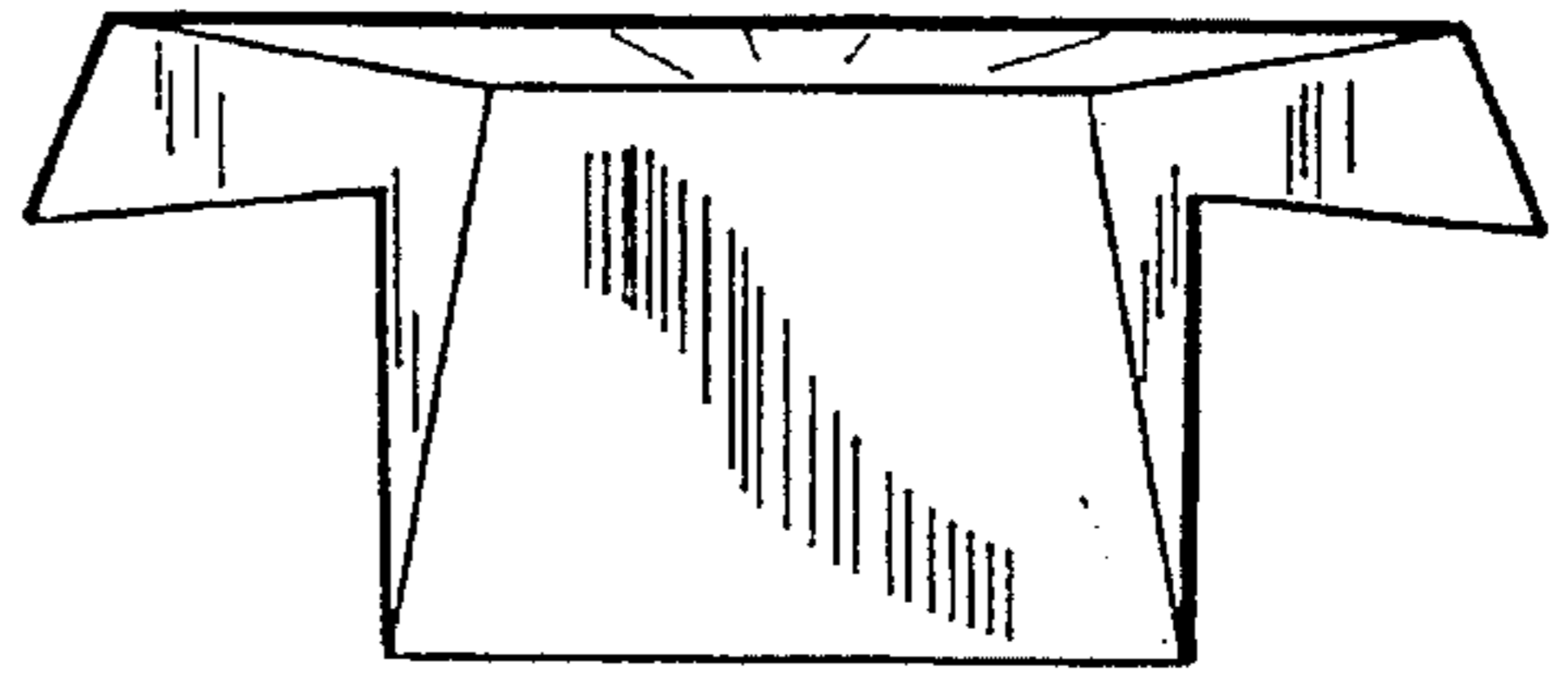

FIG. 53

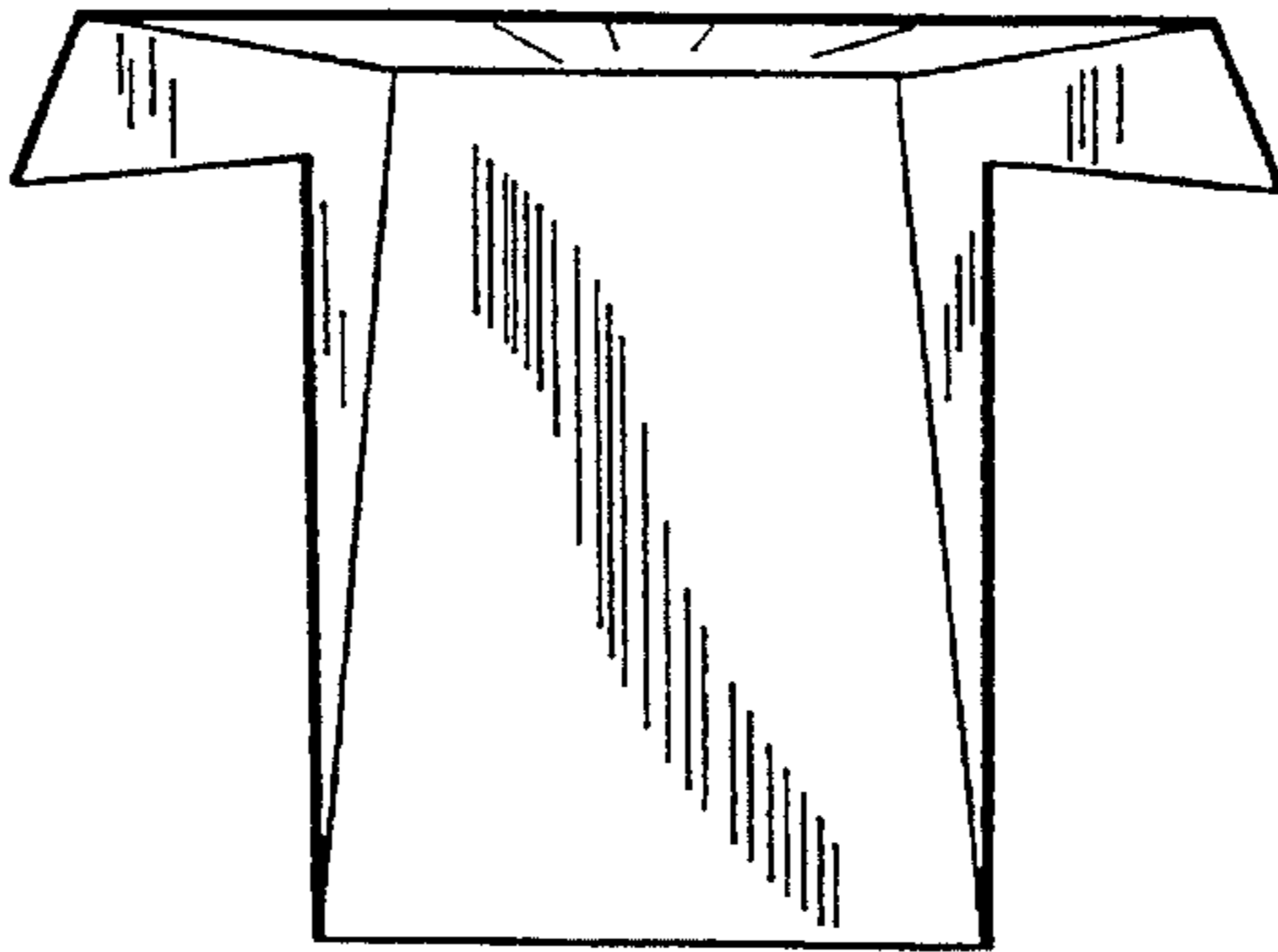

FIG. 54

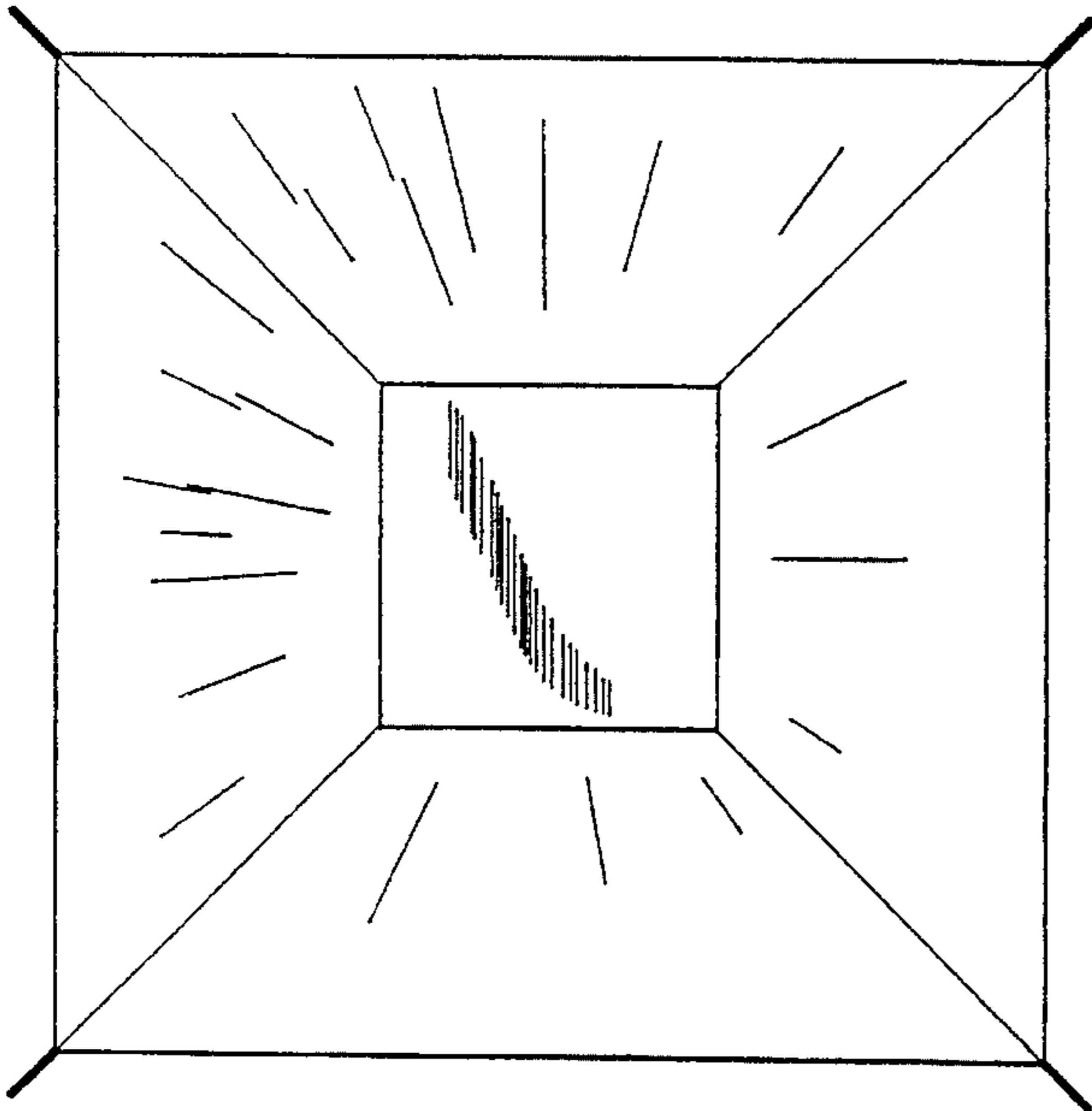

FIG. 55

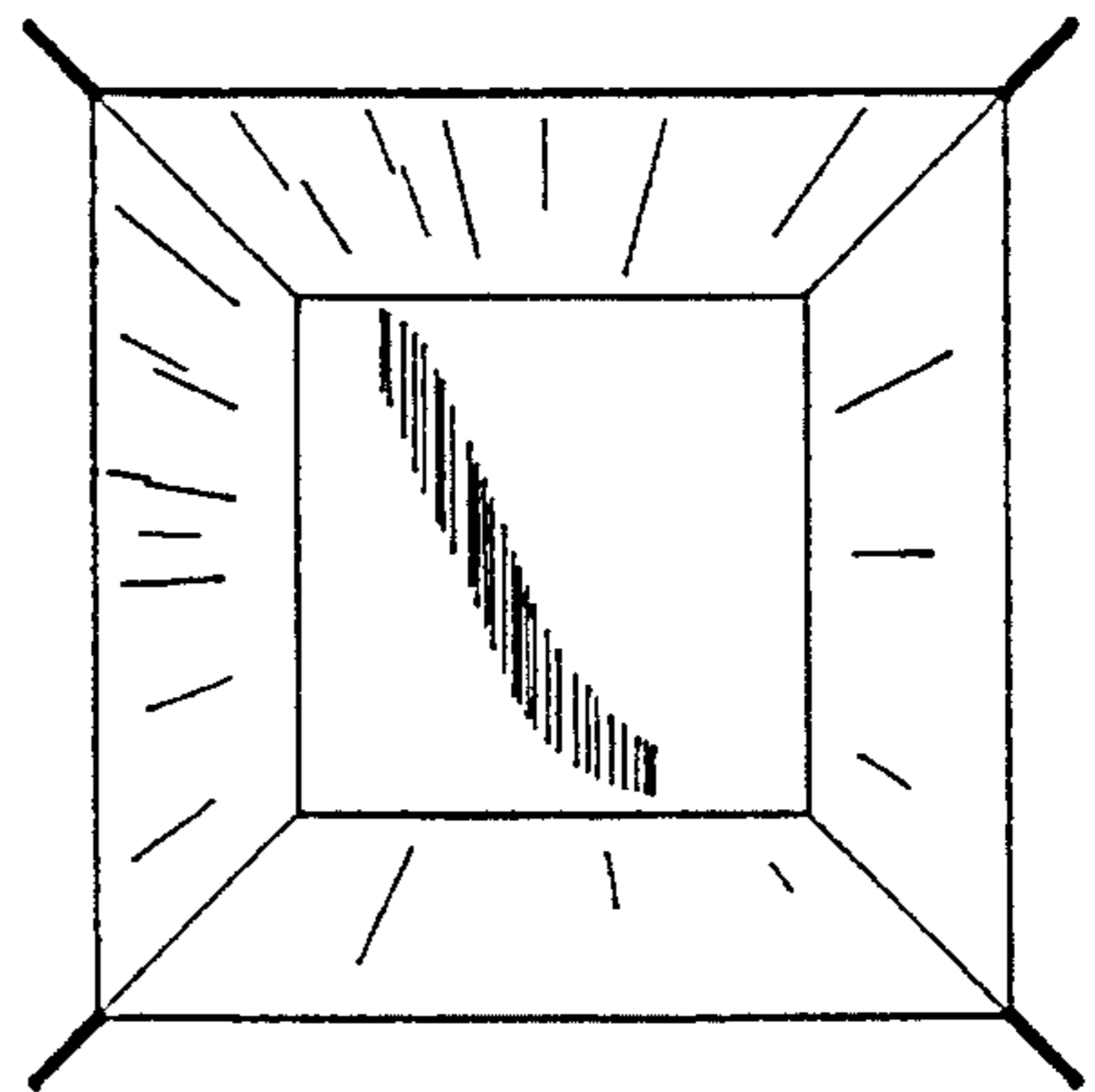

FIG. 56