



US00D370383S

United States Patent [19]

[11] **Patent Number: Des. 370,383**

Brefka

[45] **Date of Patent: **Jun. 4, 1996**

[54] **PASTA MACHINE**

[75] Inventor: **Paul Brefka**, Southborough, Mass.

[73] Assignee: **Creative Technologies Corp.**,
Brooklyn, N.Y.

[**] Term: **14 Years**

[21] Appl. No.: **35,887**

[22] Filed: **Mar. 8, 1995**

[52] U.S. Cl. **D7/376**

[58] Field of Search D7/368, 376, 381,
D7/386, 601; 366/91, 92, 98; 425/190,
191, 204, 205, 72.1

[56] **References Cited**

U.S. PATENT DOCUMENTS

D. 265,715	8/1982	Osrow et al.	D7/376
D. 267,771	2/1983	Cavalli	D7/376
5,324,185	6/1994	Backus et al.	425/72.1

OTHER PUBLICATIONS

HFD—Retailing Home Furnishings; May 26, 1980; p. 31;
Section One, Bialetti Pasta Maker.
HFD—Retailing Home Furnishings; Mar. 16, 1981; p. 22;
Section 1; La Nonna Pasta Maker.

Primary Examiner—Alan P. Douglas
Assistant Examiner—Caron D. Veynar
Attorney, Agent, or Firm—Helfgott & Karas

[57] **CLAIM**

The ornamental design for a pasta machine, as shown.

DESCRIPTION

FIG. 1 is a top perspective view of the pasta machine of my design;

FIG. 2 is a top view thereof;

FIG. 3 is a left side view thereof;

FIG. 4 is a front view thereof;

FIG. 5 is a right side view thereof;

FIG. 6 is a back view thereof; and,

FIG. 7 is a bottom view thereof.

1 Claim, 2 Drawing Sheets

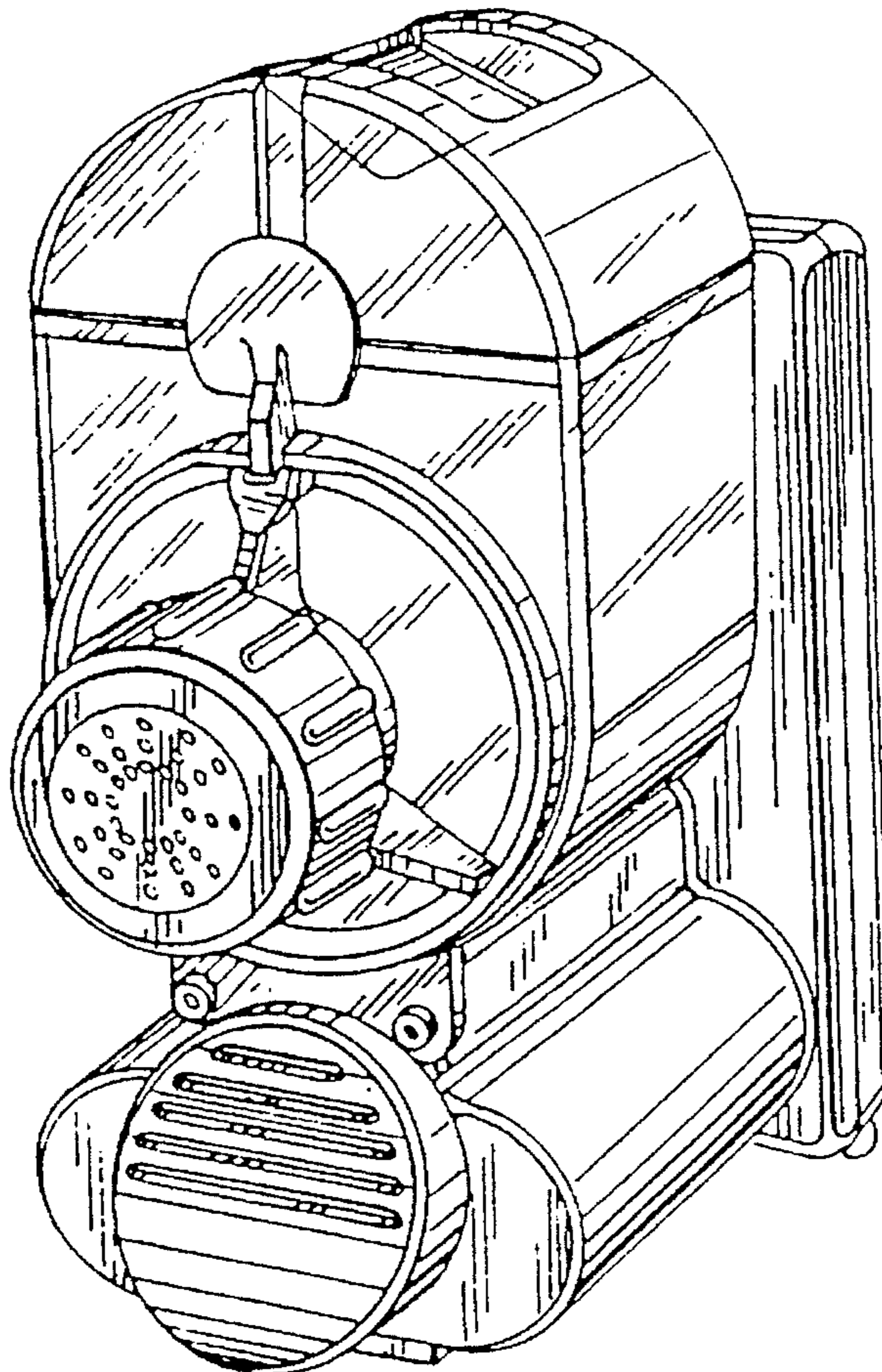

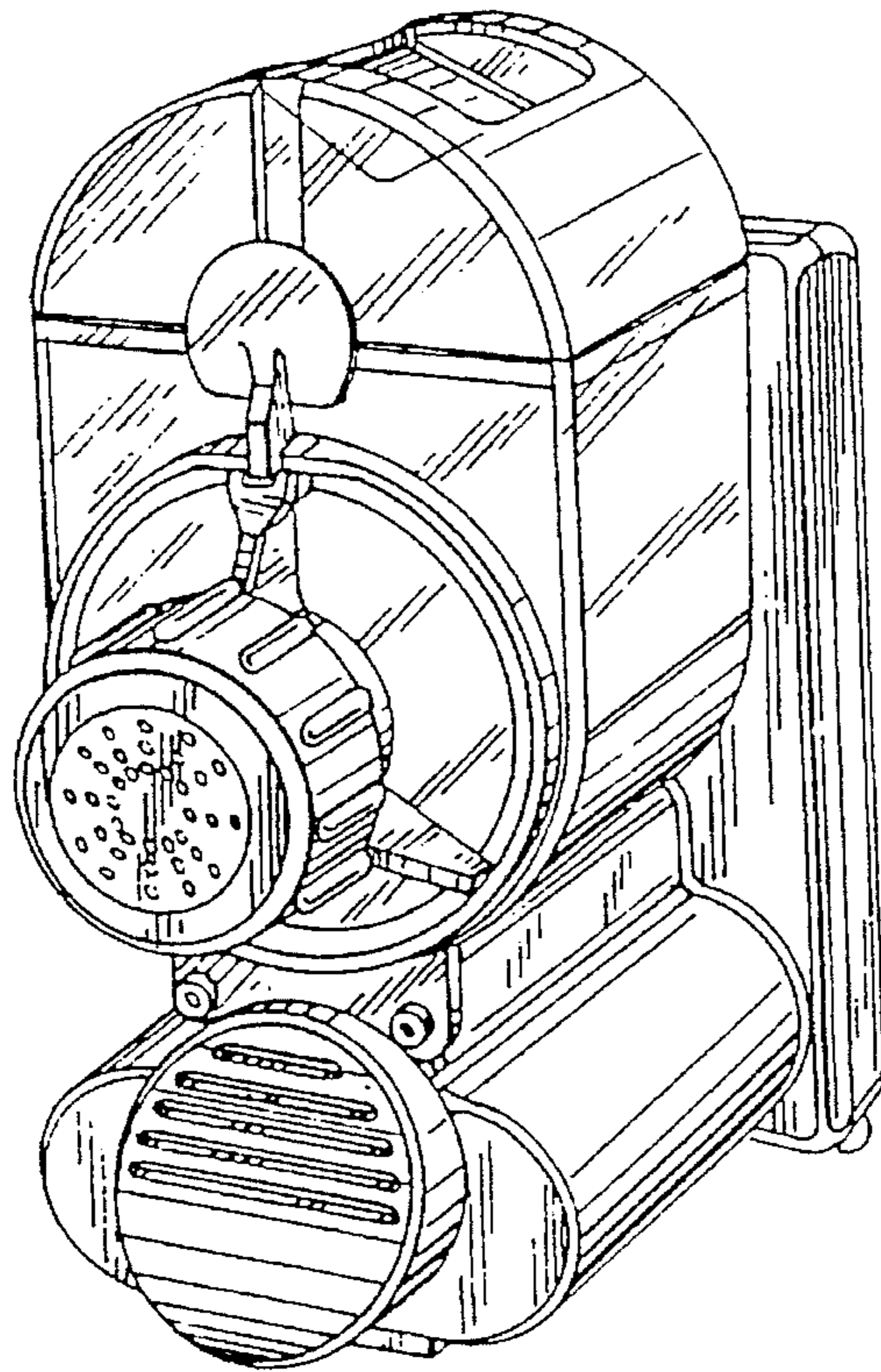

FIG. 1

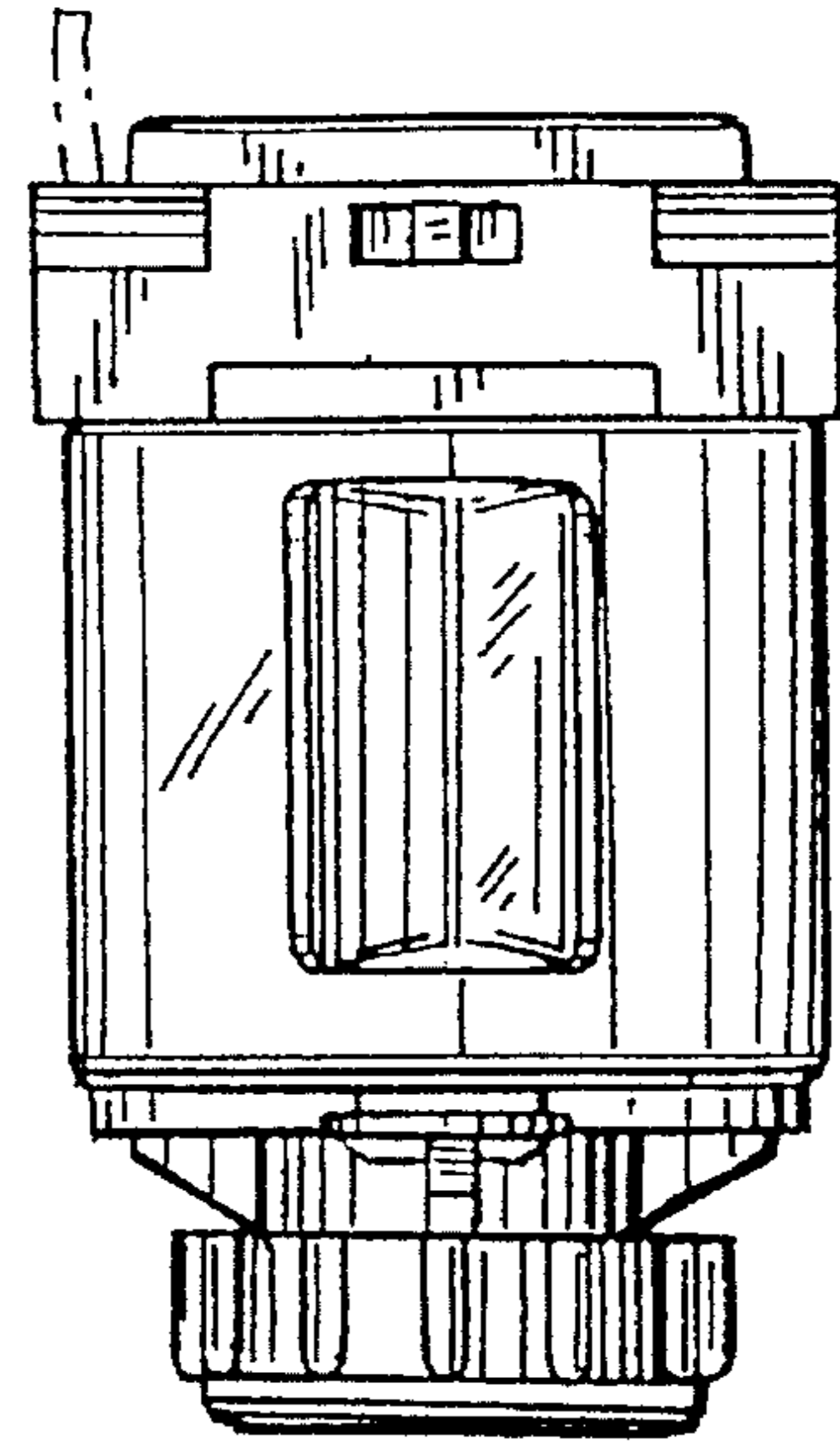

FIG. 2

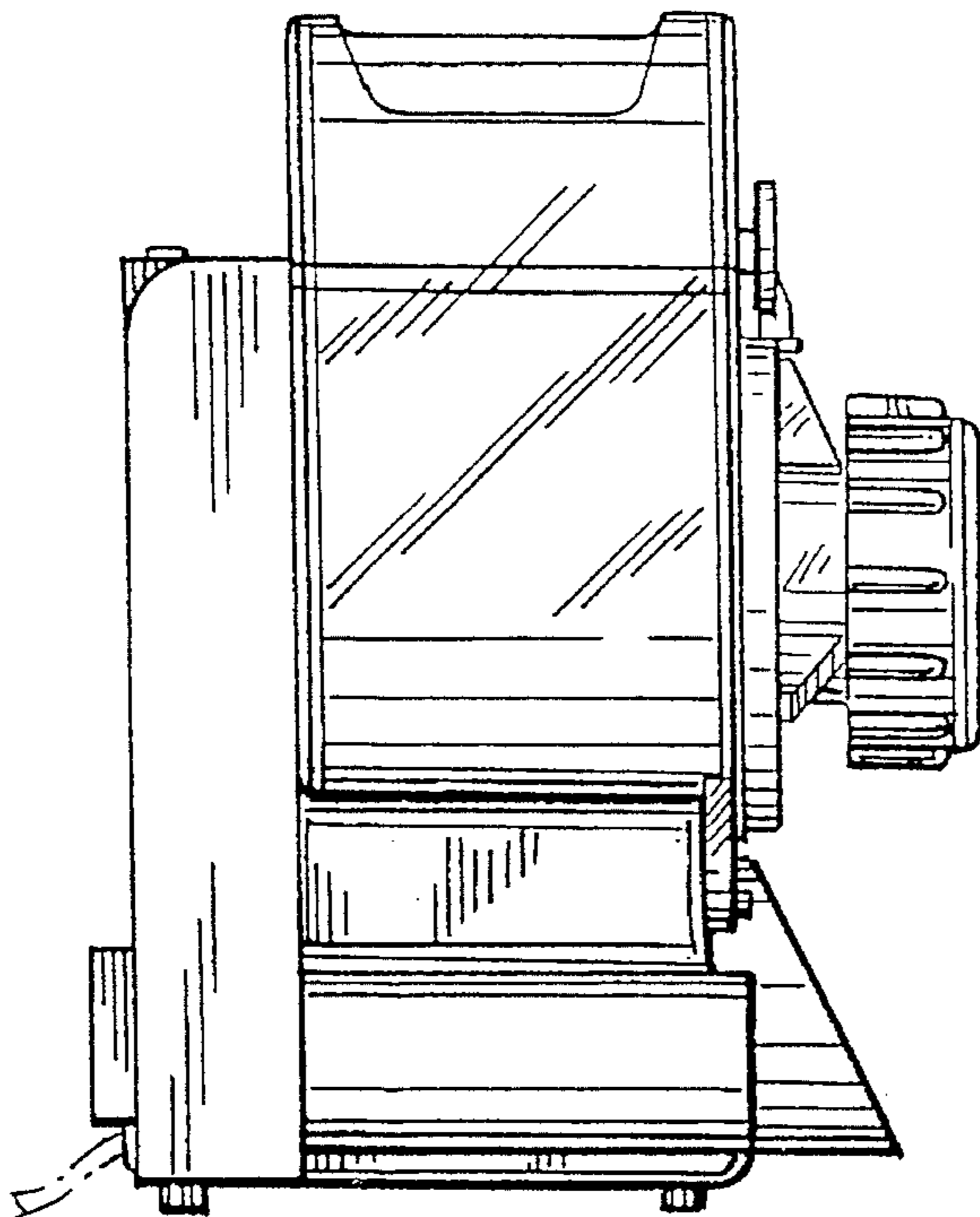

FIG. 3

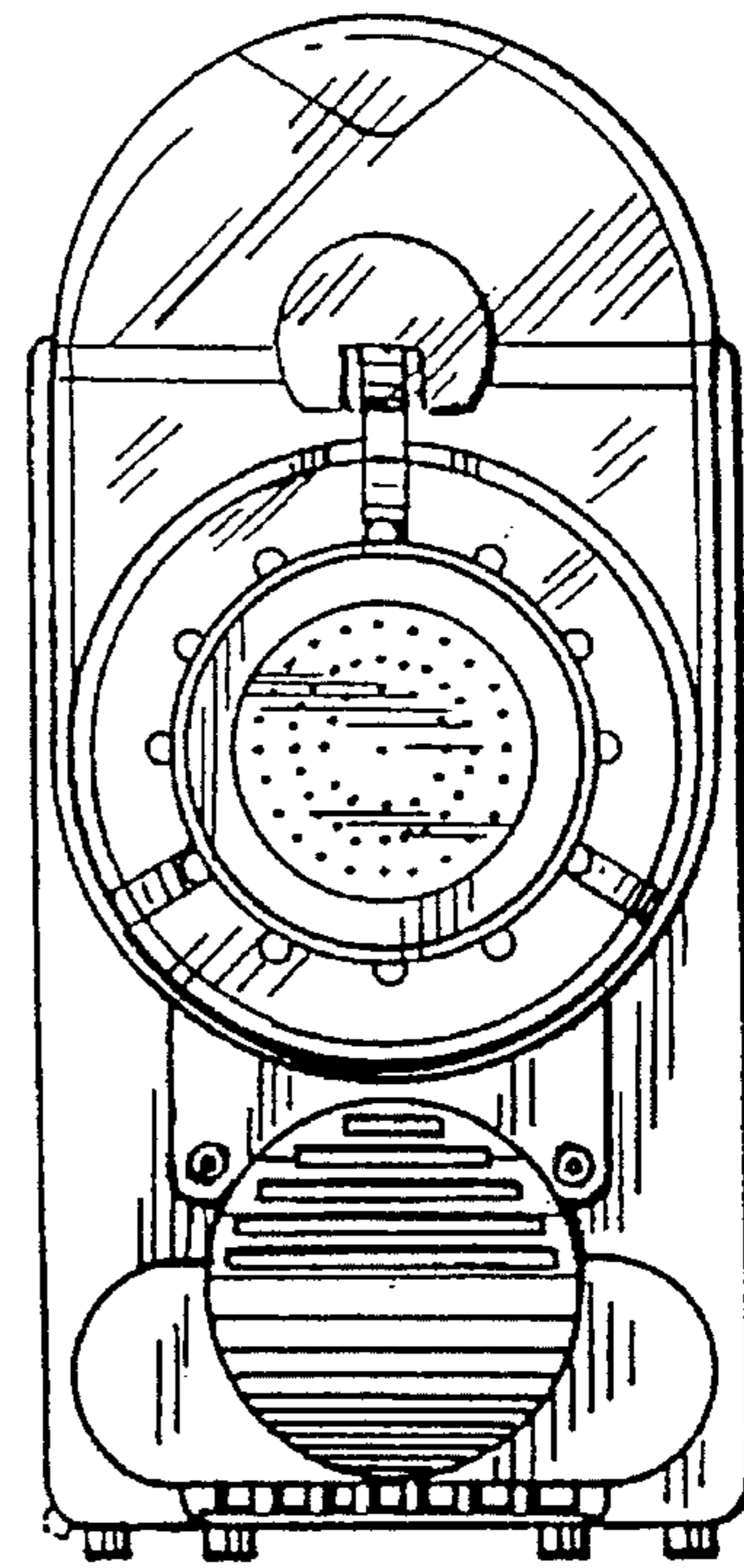

FIG. 4

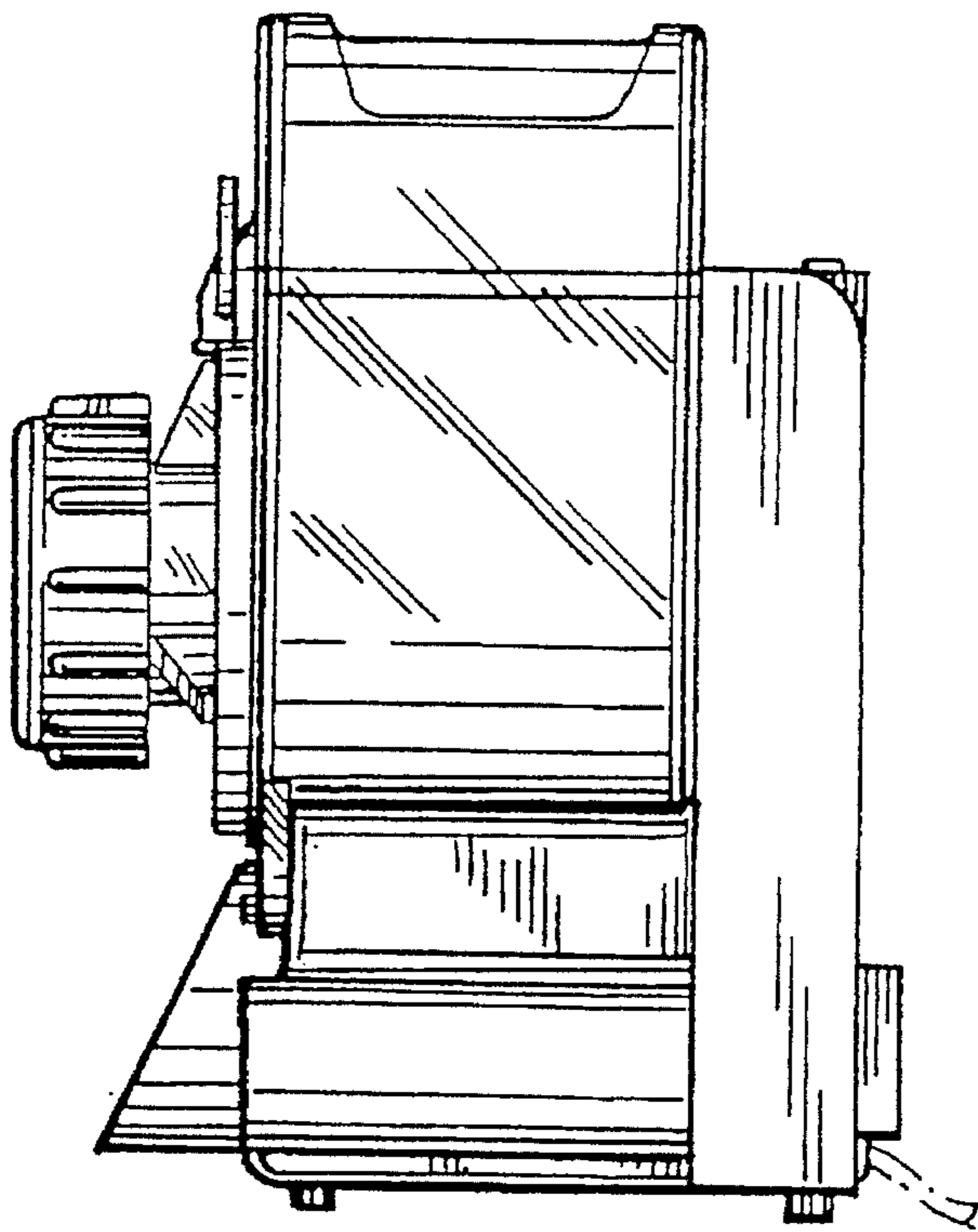

FIG. 5

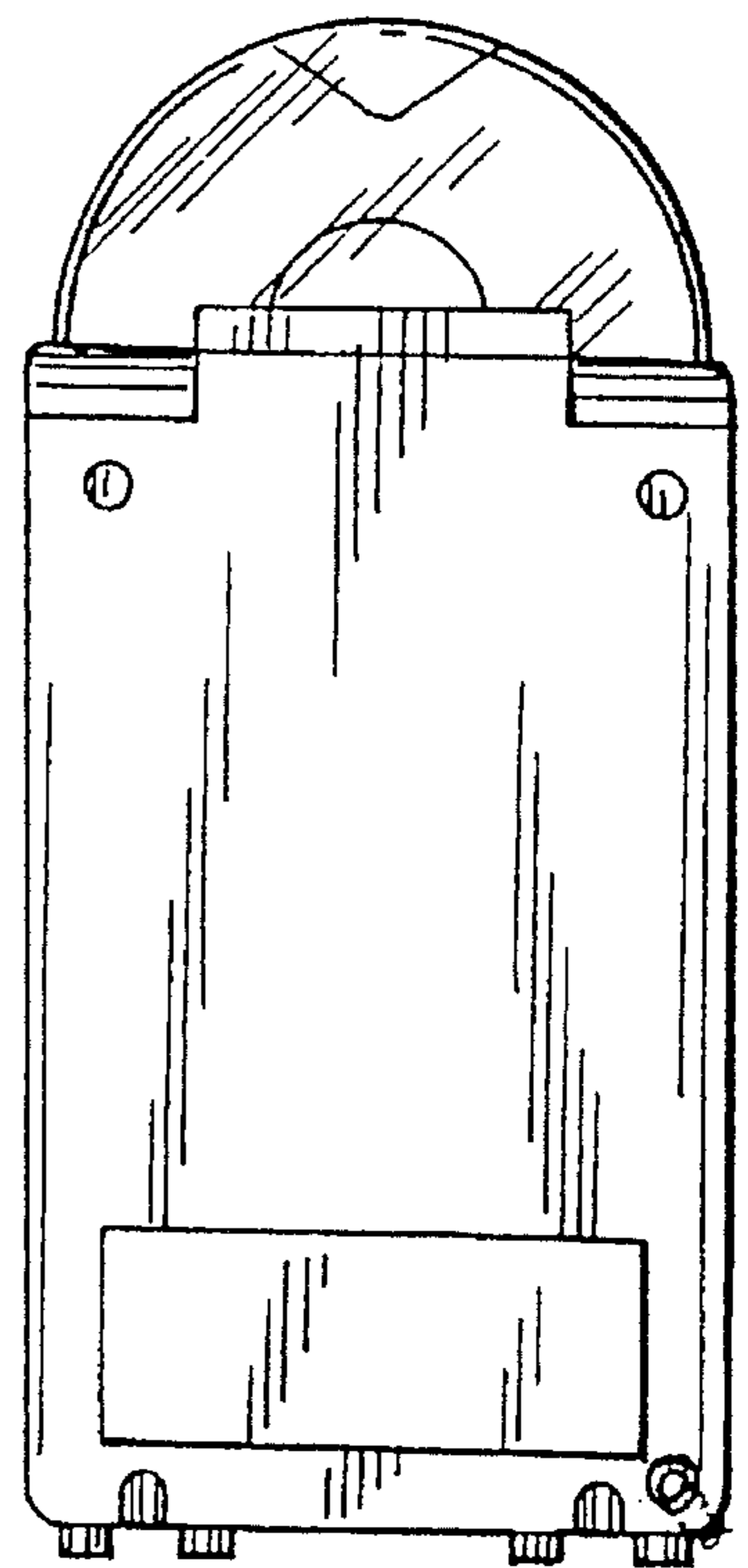

FIG. 6

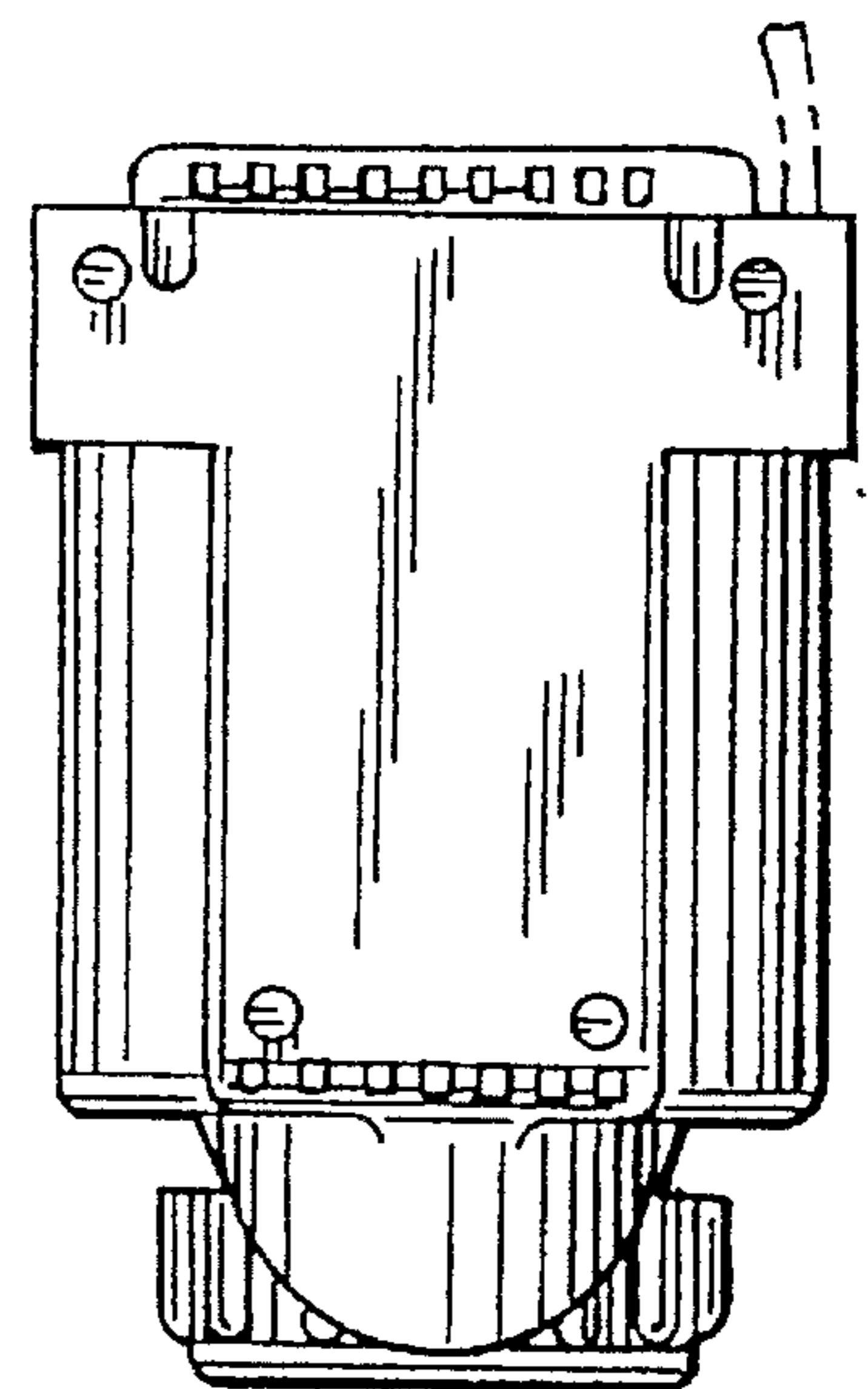

FIG. 7