



US00D370326S

United States Patent [19]

[11] Patent Number: **Des. 370,326**

Chapman et al.

[45] Date of Patent: ****May 28, 1996**

[54] **LAWN CART**

[75] Inventors: **Richard H. Chapman**, Camillus; **Scott W. Osiecki**, Skaneateles, both of N.Y.

[73] Assignee: **Rubbermaid Specialty Products, Inc.**, Wooster, Ohio

[**] Term: **14 Years**

[21] Appl. No.: **42,107**

[22] Filed: **Aug. 1, 1995**

[52] U.S. Cl. **D34/16; D34/12**

[58] Field of Search D34/12, 16, 26,
D34/25, 27; 280/47.31, 47.18, 47.26, 47.12,
652, 52, 42

[56] **References Cited**

U.S. PATENT DOCUMENTS

D. 175,069	7/1955	Gandola	D14/3
D. 309,812	8/1990	Wolters et al.	D34/26
D. 318,165	7/1991	Ayres	D34/26
D. 318,551	7/1991	Ayres	D34/24
D. 321,579	11/1991	Ayres	D34/26
D. 322,704	12/1991	Cummings	D34/24
D. 327,350	6/1992	Brown et al.	D34/16
D. 337,409	7/1993	Maple et al.	D34/27
D. 349,797	8/1994	Daugherty	D34/16
D. 352,584	11/1994	Boyd	D34/16
355,245	12/1886	Annin .	
D. 355,515	2/1995	Spear et al.	D34/16
D. 356,411	3/1995	Gingras et al.	D34/16
D. 361,191	8/1995	Kowalski et al.	D34/27

(List continued on next page.)

OTHER PUBLICATIONS

Sell sheet, Cart; Stinger Environmental Products, 3300 PGA Boulevard, Suite 450, Palm Beach Gardens, Florida 33410. Published at least as early as Nov., 1992.

Sell sheet, Carts; Ayres, R.D. 1, Wawaka, Indiana 46794. Published at least as early as 1988.

Sell sheet, cart; Kadco USA, P.O. Box 2307, Wilton, New York 12866. Published at least as early as 1988.

Sell sheet, Cart; Lambert Corporation, 117 South Third Street, Ansonia, Ohio 45303. Published at least as early as 1988.

Sell sheet, Cart; Garden Way, address unknown. Published at least as early as 1988.

Sell sheet, Cart; Contico Manufacturing Company, 1101 Warson Road, St. Louis, Missouri 63132. Published at least as early as 1988.

Sell sheet; Cart; Metal Products Co., P.O. Box 105, Cokato, Minnesota 55321. Published at least as early as 1988.

Catalog page, Cart, Shoisel, C & V Inc., Fredericksburg, Virginia 22401. Published at least as early as 1988.

Sell sheet, Cart; Allegheny International Hardware Group, True Temper, Jackson, Cyclone, Wilkinson Sword, P.O. Box 3500, Shiremanstown, Pennsylvania 17011. Published at least as early as 1988.

Pp. 3 and 4, Carts; Kelley Manufacturing Co, 4800 Clinton Drive, Houston, Texas 77020. Published at least as early as 1988.

Sell sheet, Cart; Sterling Handling Equipment Inc., P.O. Box 09743, 2300 West Florist Avenue, Milwaukee, Wisconsin 53209. Published at least as early as 1988.

Catalog page, Carts; Nasco, 901 Janesville Avenue, Fort Atkinson, Wisconsin 53538. Publication date 1989.

Pp. 46 and 48, Carts; Ames, Box 1774, Parkersburg, West Virginia 26101. Publication date May, 1986.

Primary Examiner—Kay H. Chin

Attorney, Agent, or Firm—Richard B. O'Planick; Lisa B. Riedesel

[57] **CLAIM**

The ornamental design for a lawn cart, as shown and described.

DESCRIPTION

FIG. 1 is a top right front perspective view of a lawn cart showing our new design. The broken lines are for illustrative purposes only and form no part of the claimed design;

FIG. 2 is a front elevational view thereof; the rear elevational view being a mirror image;

FIG. 3 is a top plan view thereof;

FIG. 4 is a left side elevational view thereof;

FIG. 5 is a right side elevational view thereof; and,

FIG. 6 is a bottom plan view thereof.

1 Claim, 6 Drawing Sheets

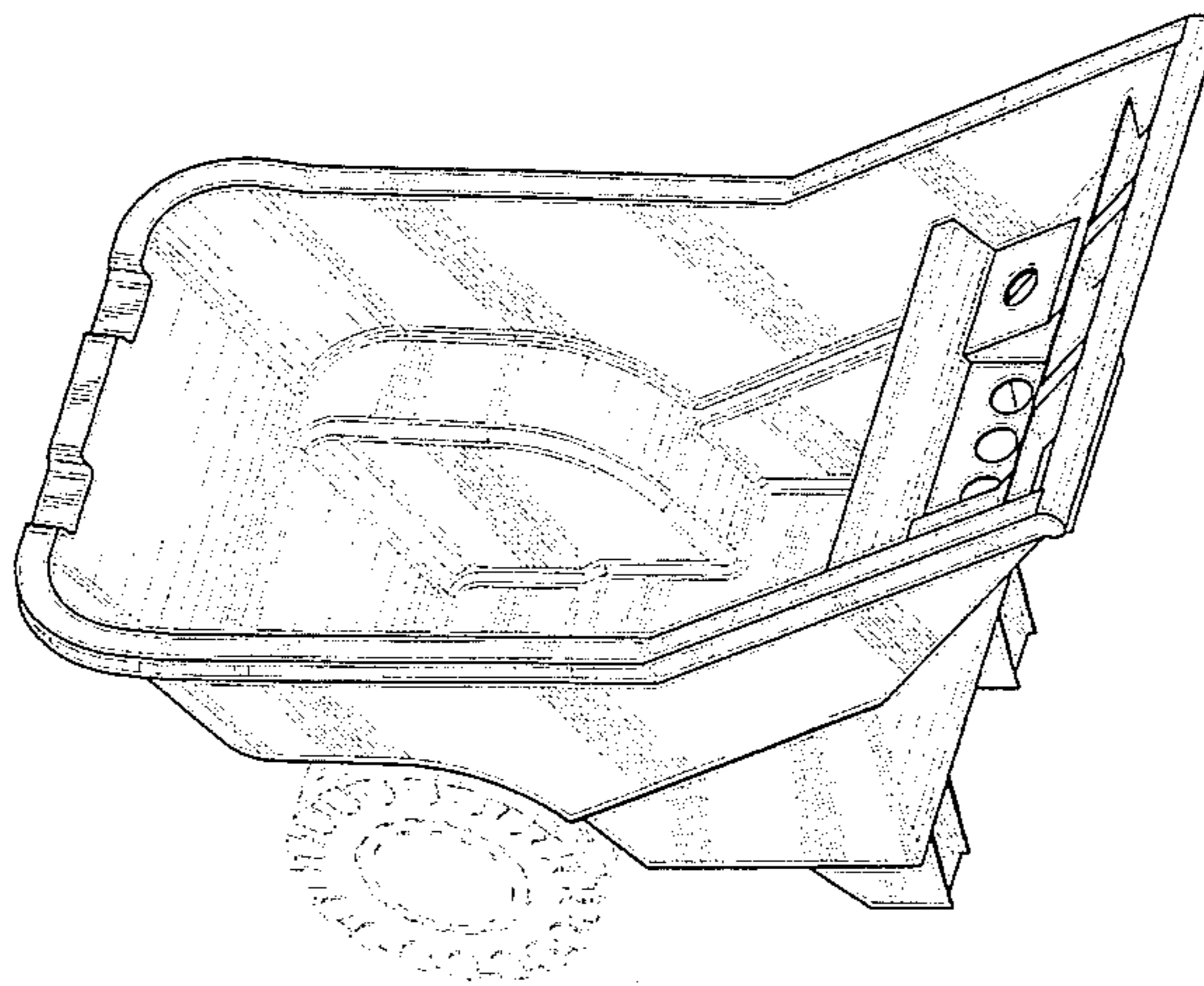

U.S. PATENT DOCUMENTS						
			3,950,004	4/1976	Olsson	280/47.18
			3,950,005	4/1976	Patterson	280/47.31
1,139,307	5/1915	Mecking .	4,261,596	4/1981	Douglas	280/652
1,965,409	7/1934	Forrer	4,335,897	6/1982	Muller, Jr.	280/47.18
		280/52	4,341,393	7/1982	Gordon et al.	280/47.26
1,969,457	8/1934	Forrer	4,417,765	11/1983	Wirsbinski	298/5
		280/52	4,607,856	8/1986	Saleeba	280/47.18
2,010,975	8/1935	Carter	4,635,956	1/1987	Morrisette	280/652
		280/52	4,645,225	2/1987	Eubanks	280/47.31
2,102,684	2/1937	Dorward	4,740,008	4/1988	Johnson	280/475
		280/51	4,758,010	7/1988	Christie	280/47.31
2,247,083	6/1941	Garlinghouse	4,767,128	8/1988	Terhune	280/47.2
		280/52	4,781,396	11/1988	King	280/653
2,800,335	7/1957	Clapp	4,824,137	4/1989	Bolden	280/652
		280/42	4,889,360	12/1989	Havlovitz	280/655.1
3,160,439	12/1964	Kzakowitz				
		298/2				
3,170,707	2/1965	Millar, Jr. et al.				
		280/47.31				
3,722,904	3/1973	Puckett				
		280/36				
3,791,470	2/1974	Baddorf et al.				
		180/19				
3,858,929	1/1975	Brescia				
		280/47.12				
3,936,070	2/1976	Owings				
		280/47.18				

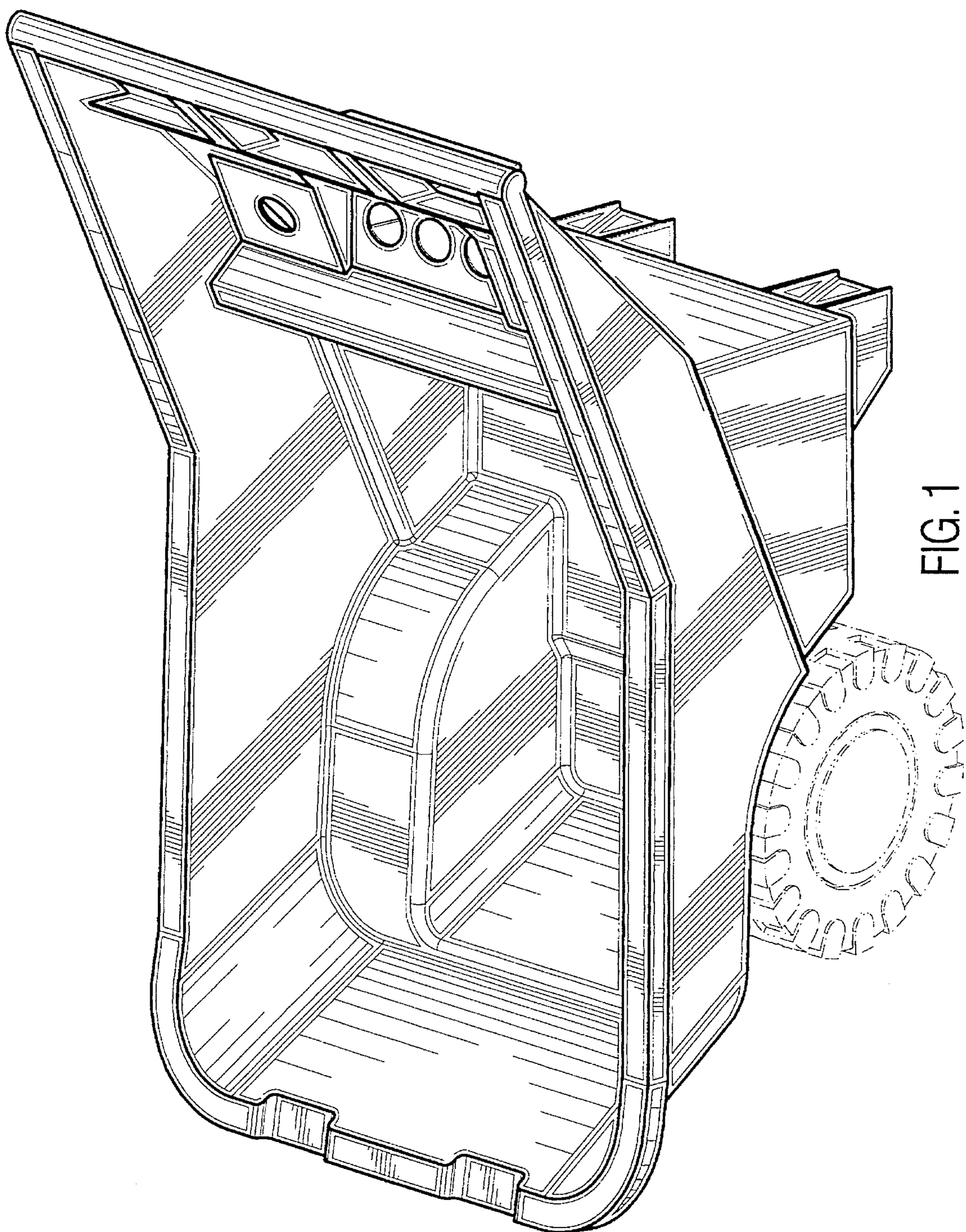

FIG. 1

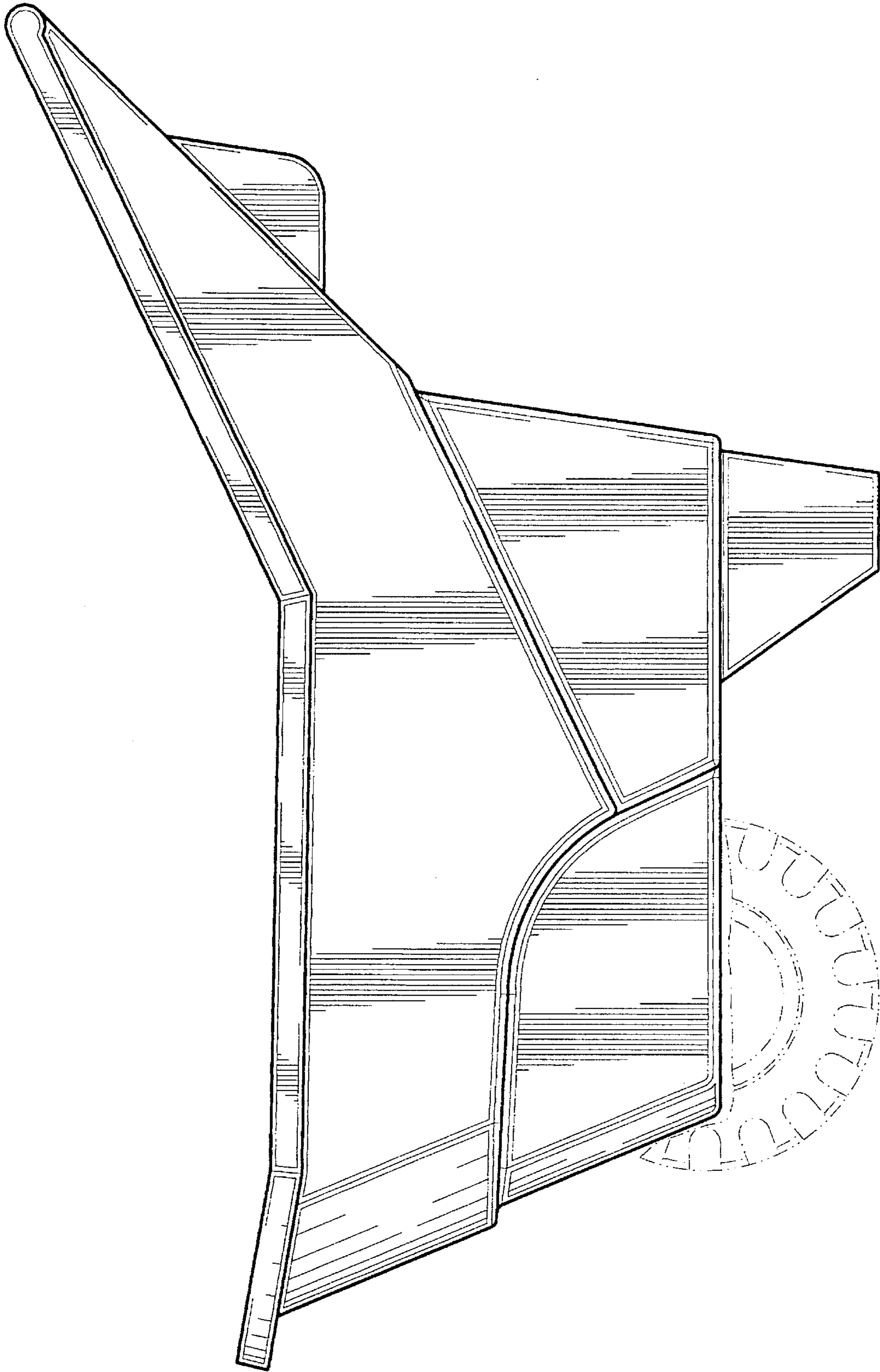

FIG. 2

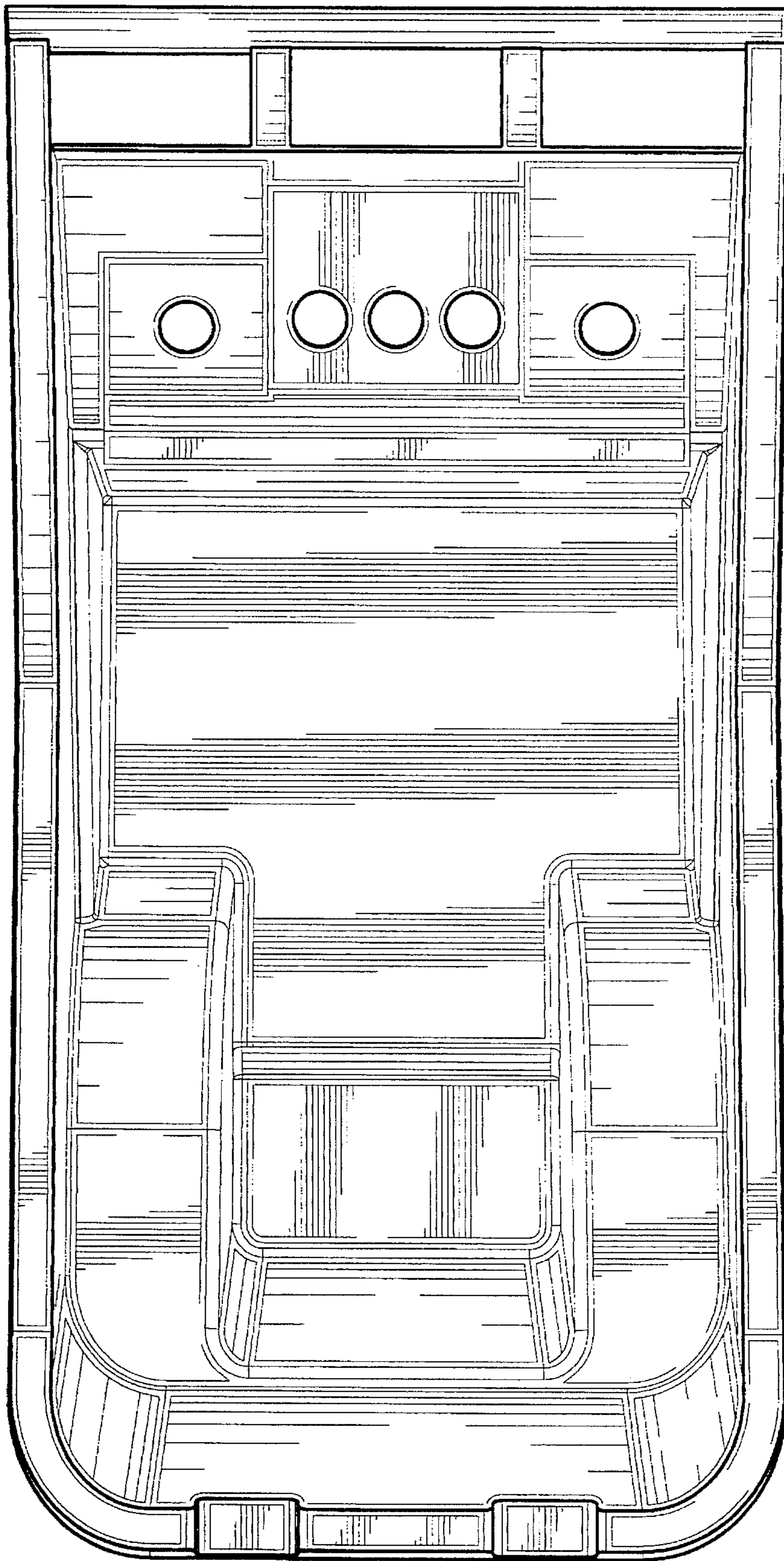

FIG. 3

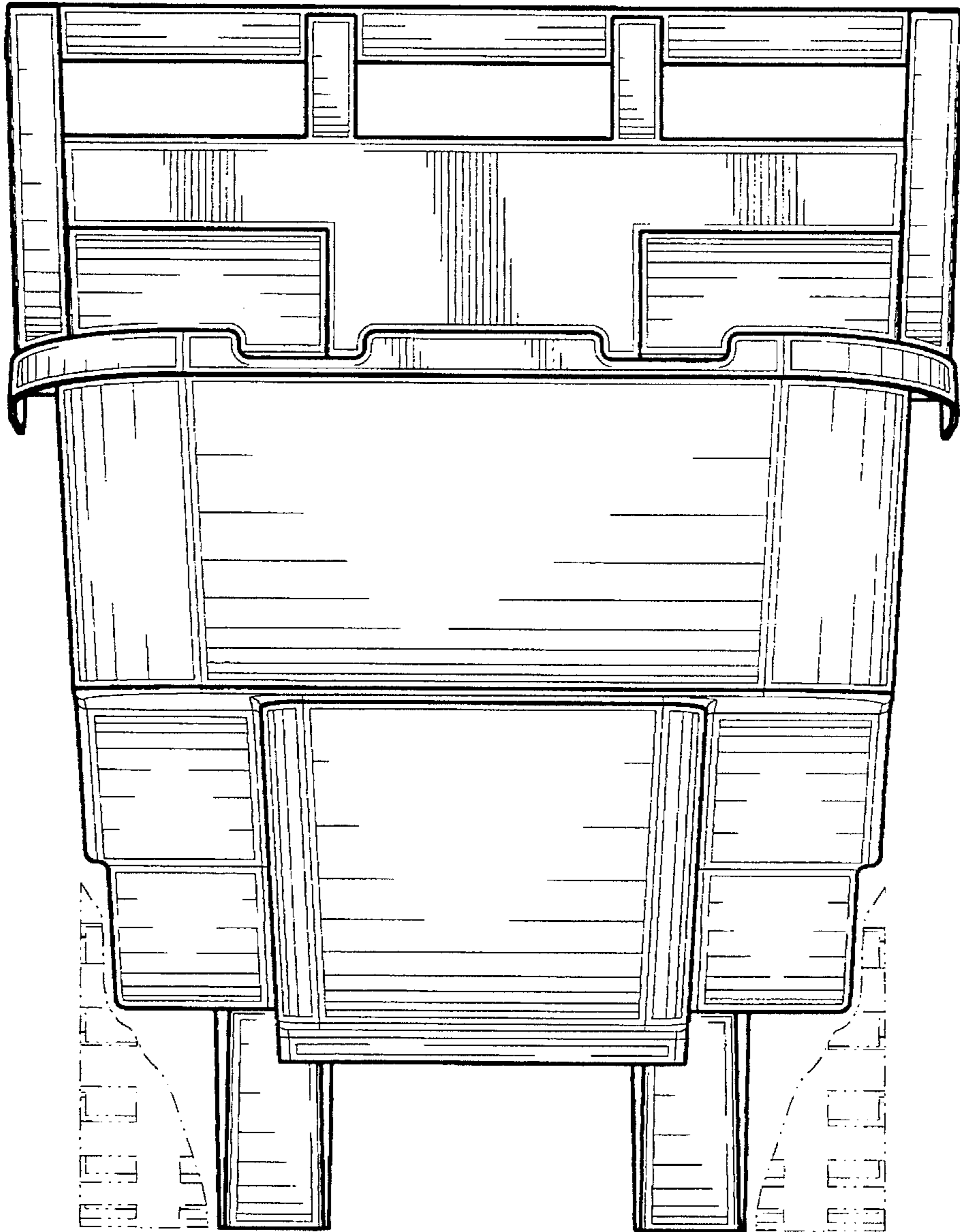

FIG. 4

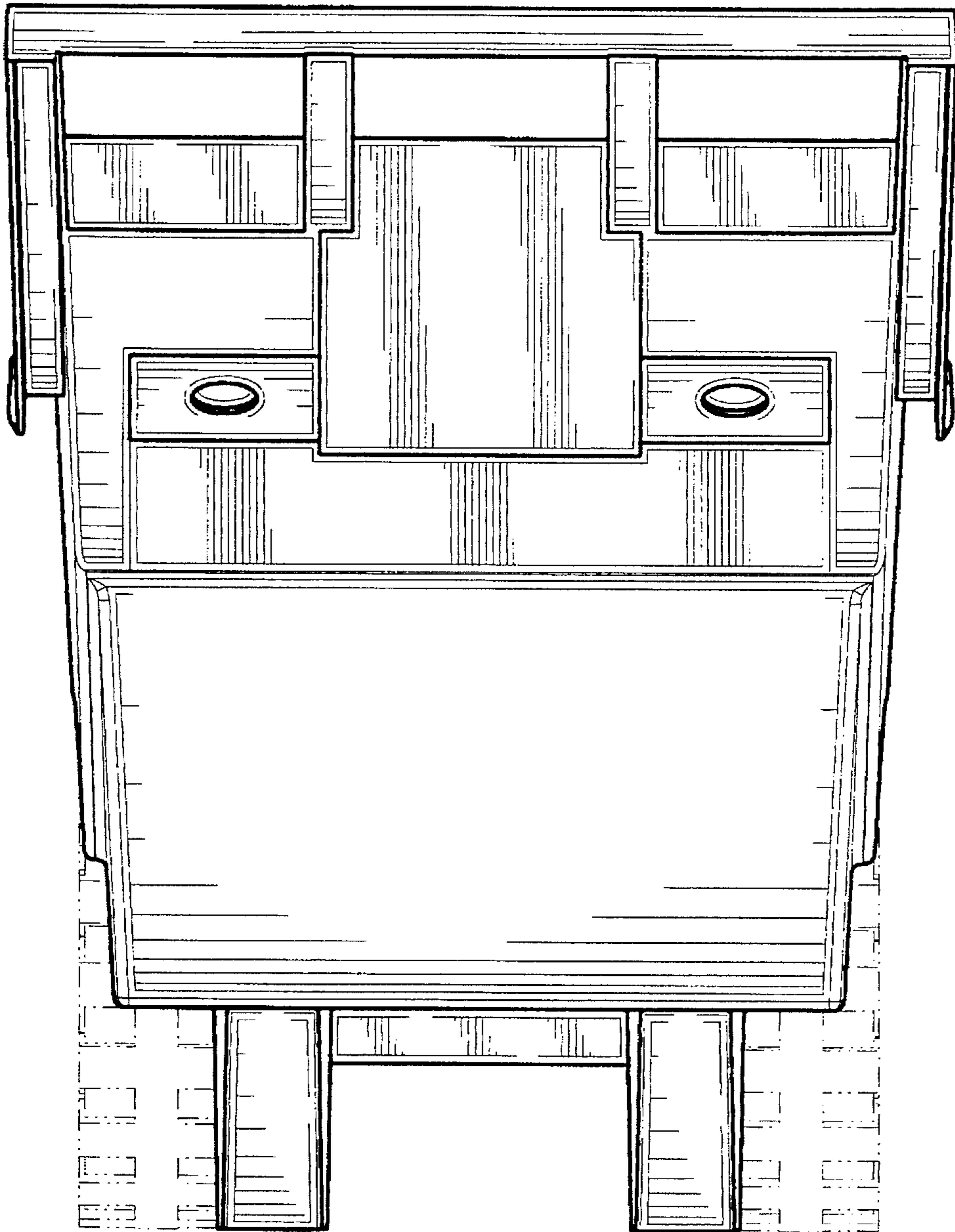

FIG. 5

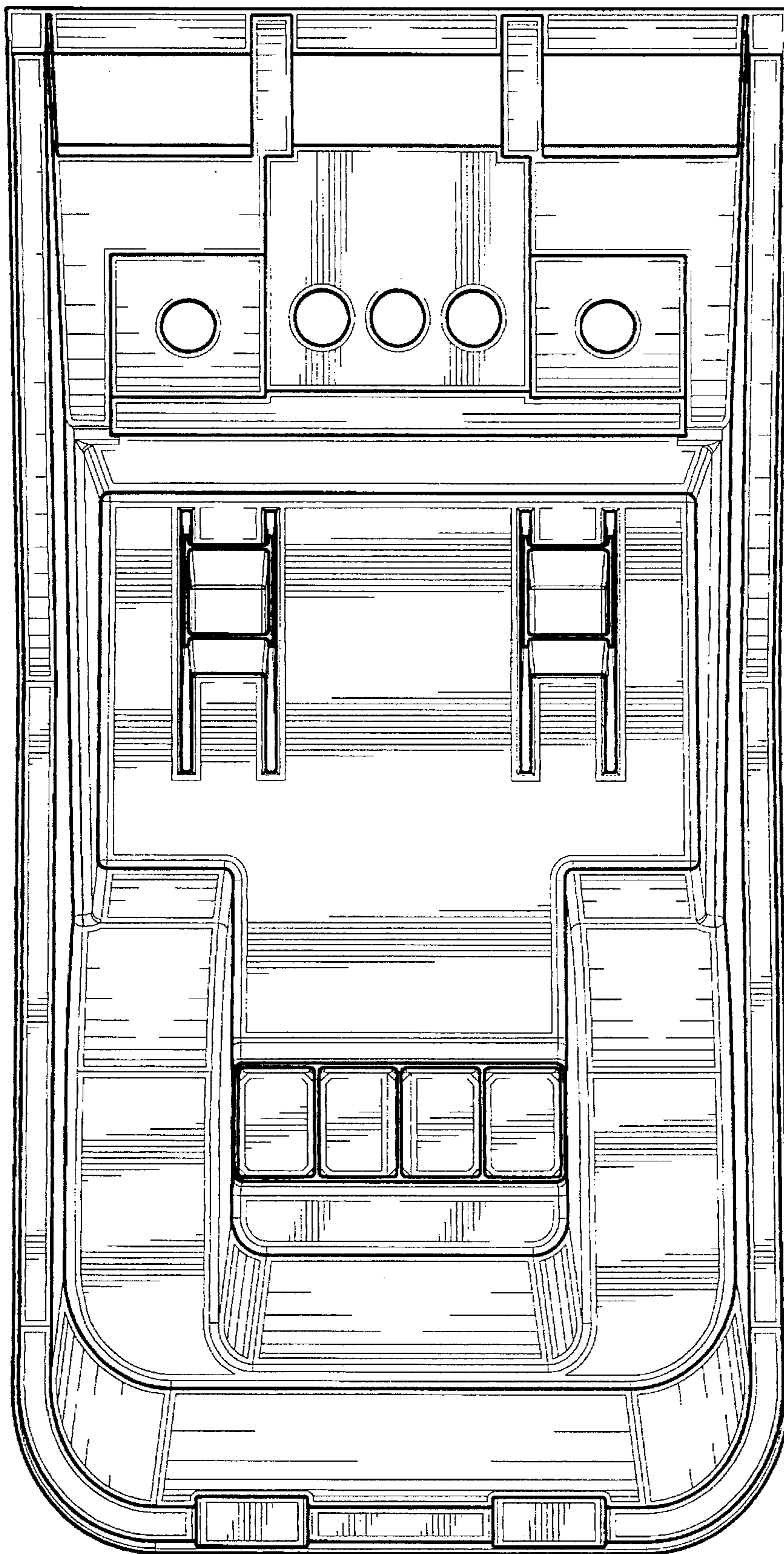

FIG. 6