



US00D370260S

United States Patent [19]

[11] Patent Number: **Des. 370,260**

Torrey

[45] Date of Patent: ****May 28, 1996**

[54] COMBINED VISION TESTER AND RECHARGING STAND THEREFOR

Attorney, Agent, or Firm—Marger, Johnson, McCollom & Stolowitz

[75] Inventor: **Jonathan G. Torrey**, Portland, Oreg.

[57] CLAIM

[73] Assignee: **Prio Corporation**, Lake Oswego, Oreg.

The ornamental design for a combined vision tester and recharging stand therefor, as shown and described.

[**] Term: **14 Years**

DESCRIPTION

[21] Appl. No.: **31,507**

FIG. 1 is a perspective view of the combined vision tester and stand therefor assembled together;
FIG. 2 is a top plan view of the vision tester;
FIG. 3 is a rear elevational view of the vision tester;
FIG. 4 is a front elevational view of the vision tester;
FIG. 5 is a right side, elevational view, the left side being substantially a mirror image thereof; and
FIG. 6 is a bottom plan view of the vision tester;
FIG. 7 is a top plan view of the recharging stand;
FIG. 8 is a rear elevational view of the recharging stand;
FIG. 9 is a front elevational view of the recharging stand;
FIG. 10 is a right side, elevational view, the left side being substantially a mirror image of the recharging stand;
FIG. 11 is a bottom plan view of the recharging stand; and,
FIG. 12 is a front elevational view of the combined vision tester and recharging stand.

[22] Filed: **Nov. 29, 1994**

[52] U.S. Cl. **D24/172**

[58] Field of Search D24/172; 351/243, 351/244, 245, 246, 232, 233, 239, 240, 203, 200

[56] References Cited

U.S. PATENT DOCUMENTS

D. 298,457	11/1988	Minkin et al.	D24/172
D. 342,317	12/1993	Orlinsky et al.	D24/172
D. 348,931	7/1994	Torrey	D24/172
4,764,007	8/1988	Task	351/243
4,998,820	3/1991	Salibello	351/243

Primary Examiner—Stella Reid

1 Claim, 6 Drawing Sheets

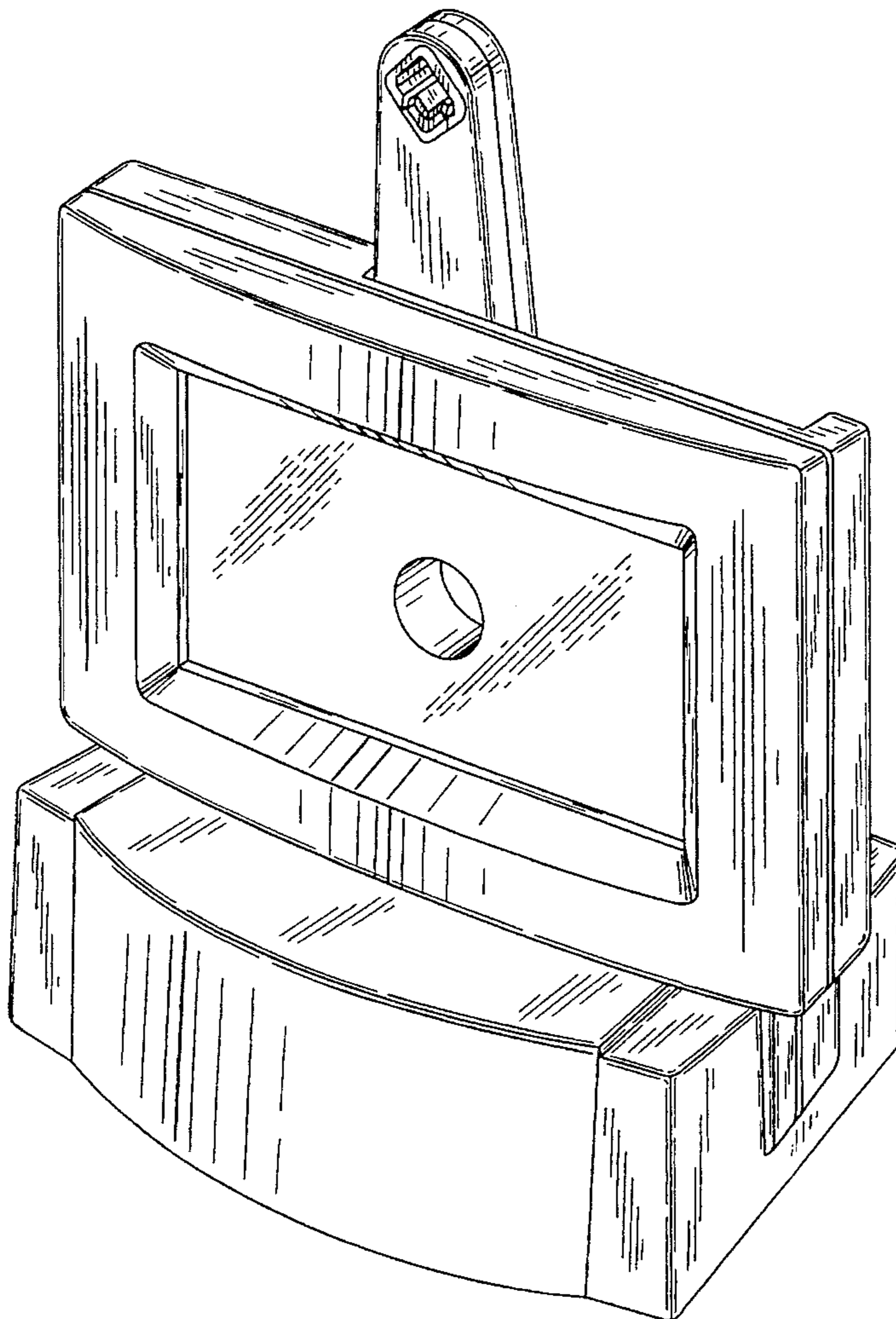

FIG. 1

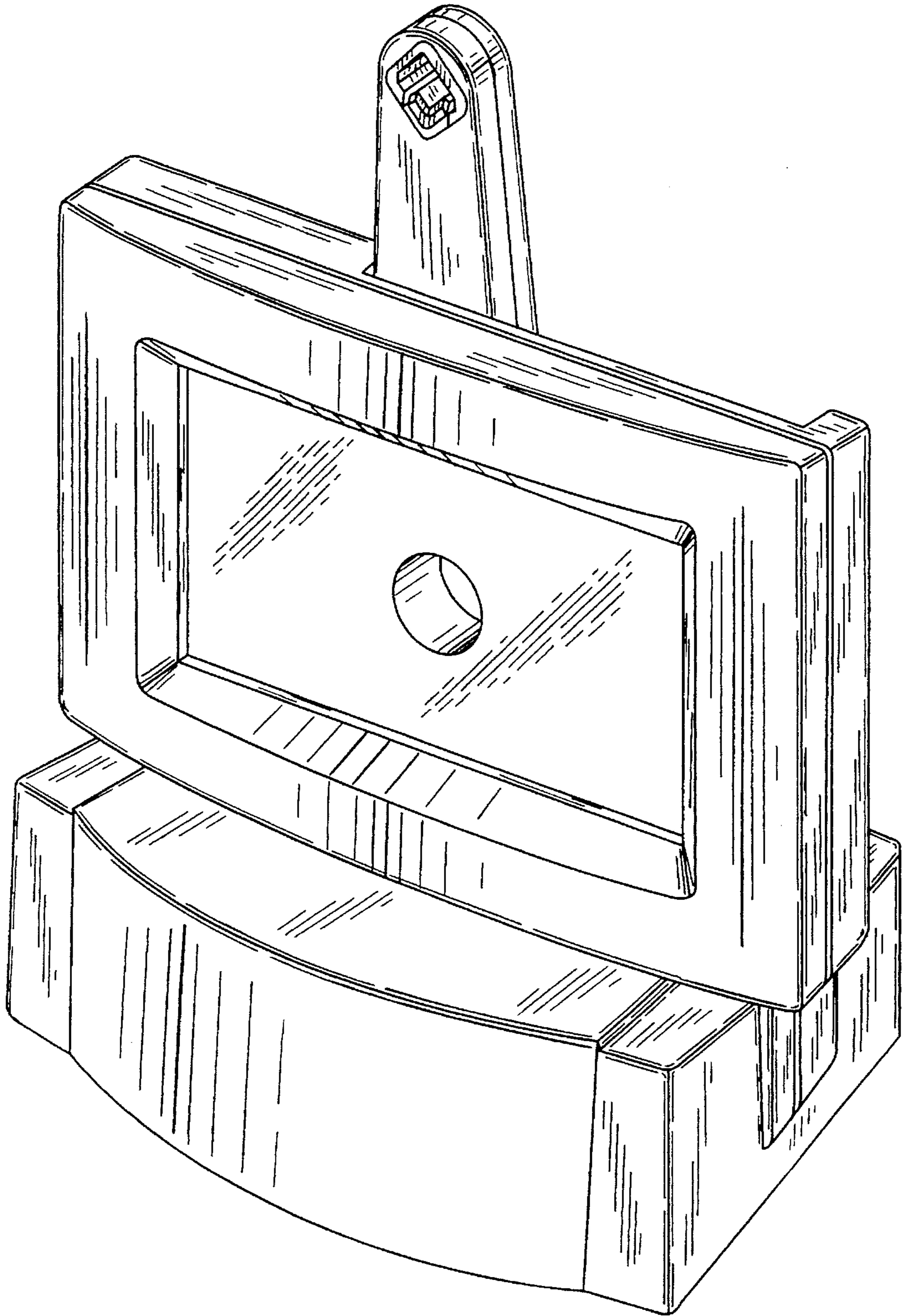

FIG. 5

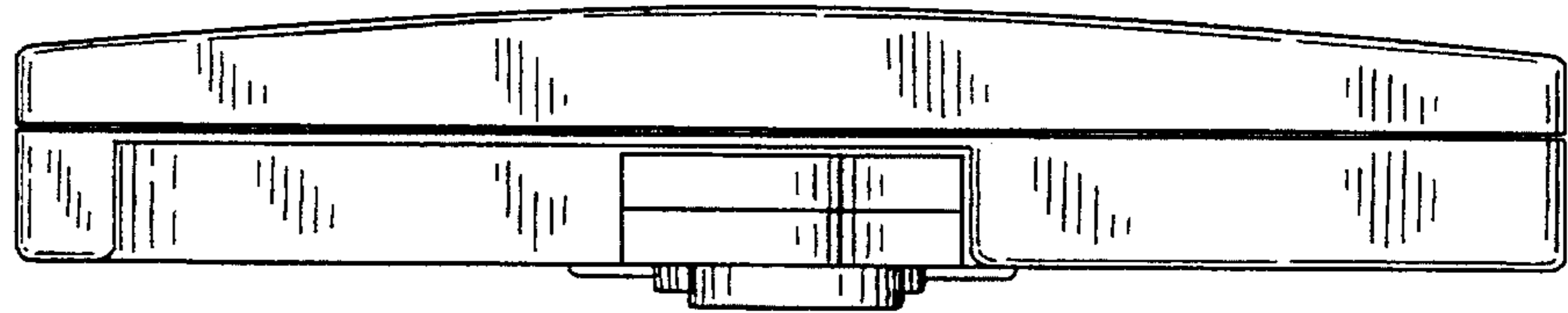
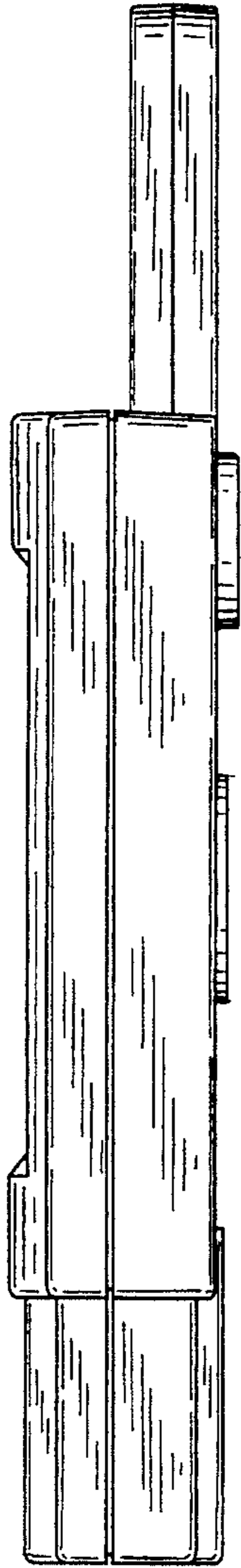

FIG. 2

FIG. 3

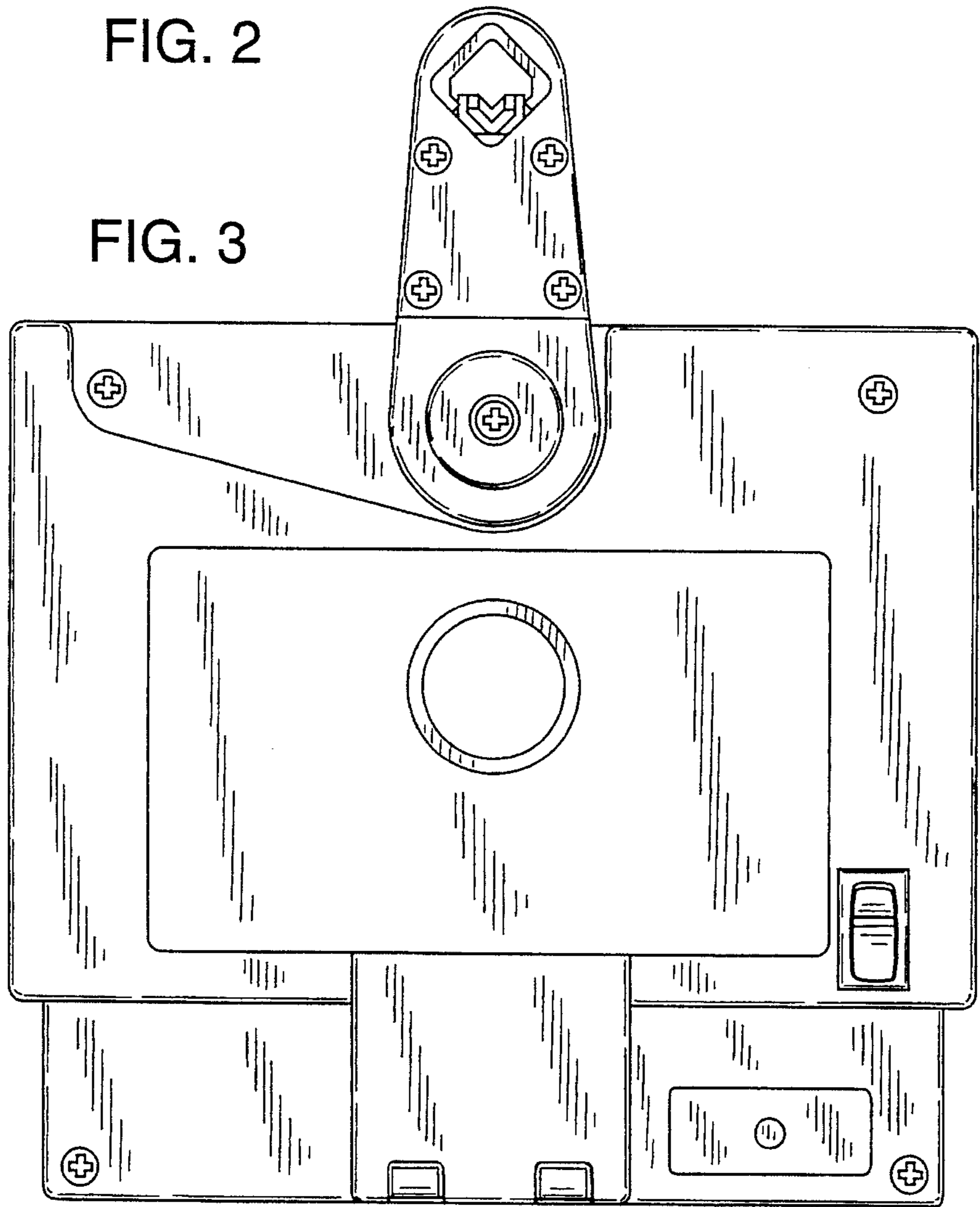

FIG. 6

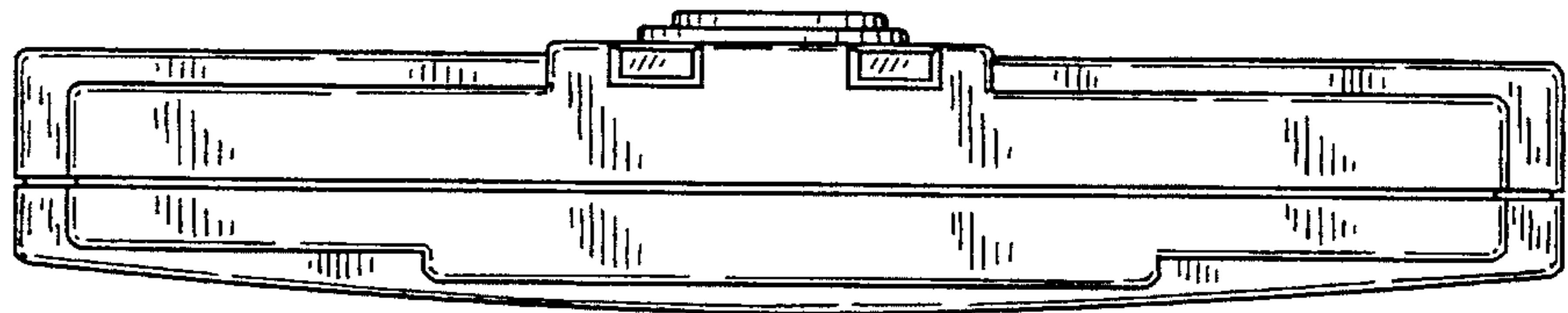
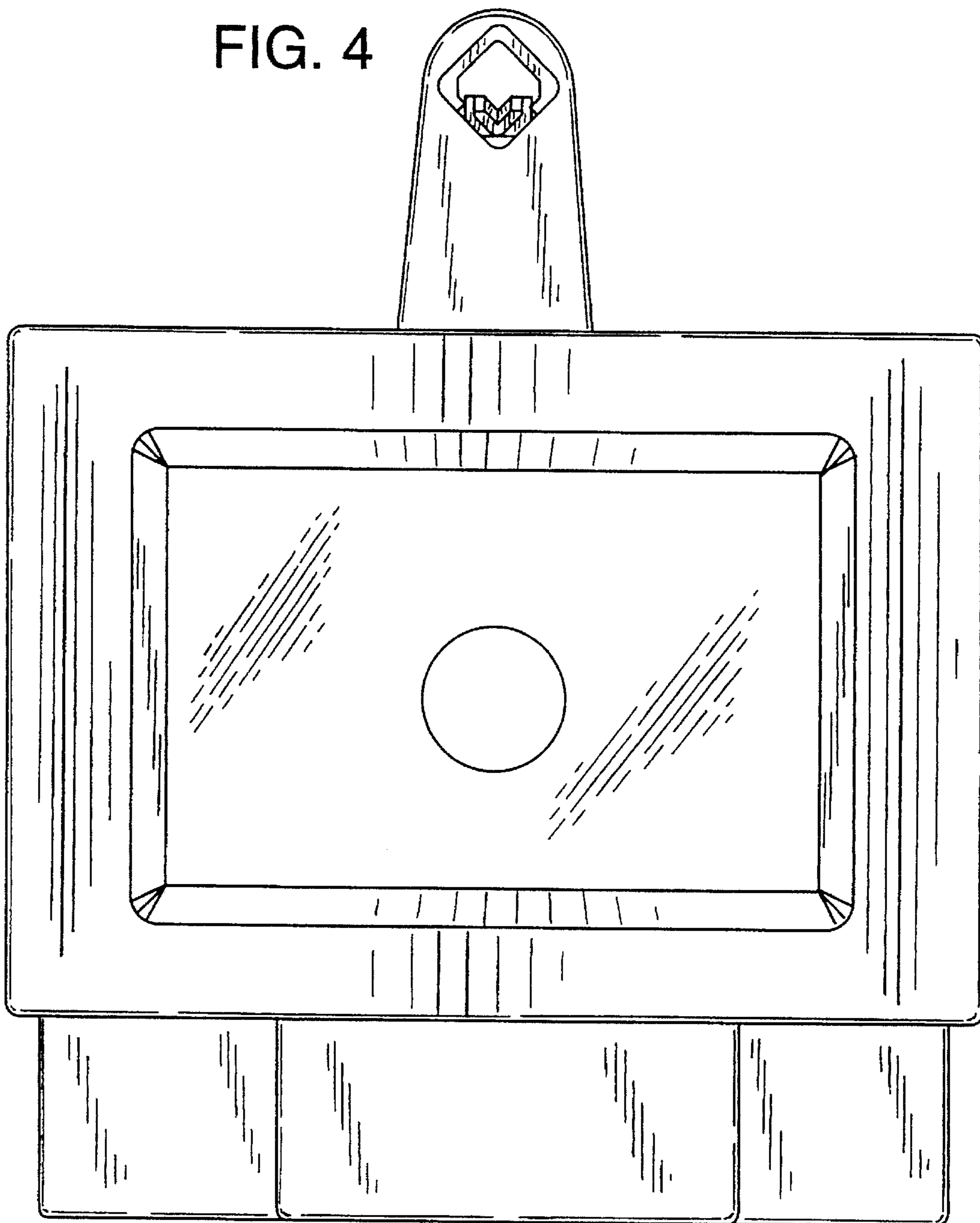

FIG. 4



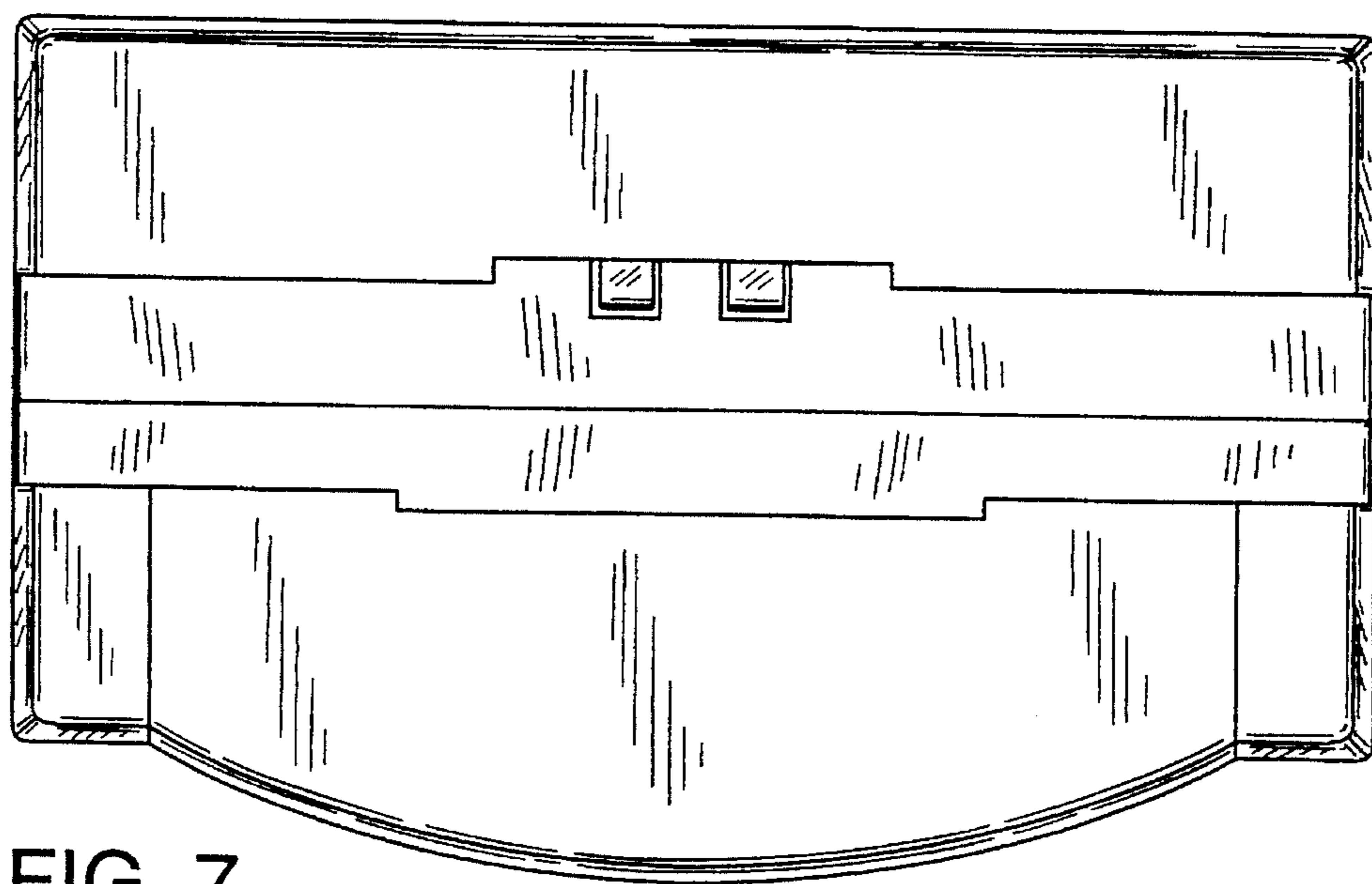

FIG. 7

FIG. 8

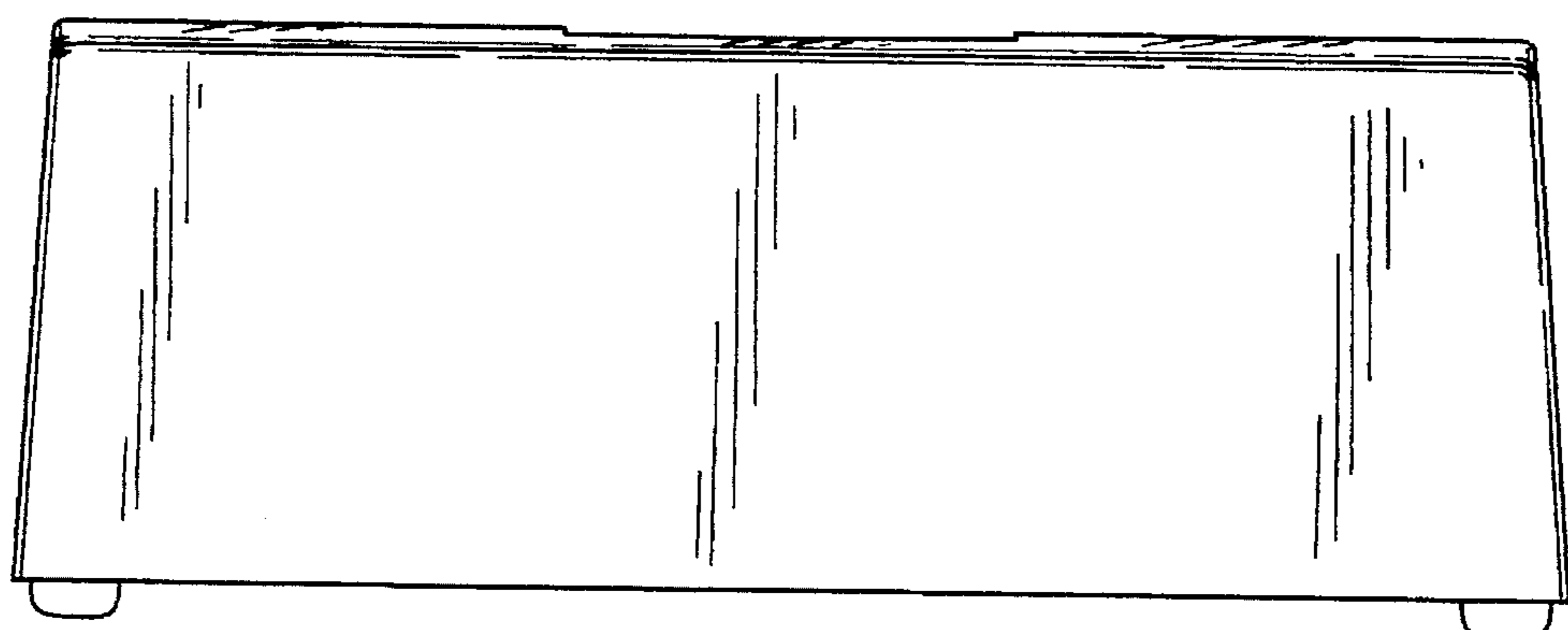

FIG. 9

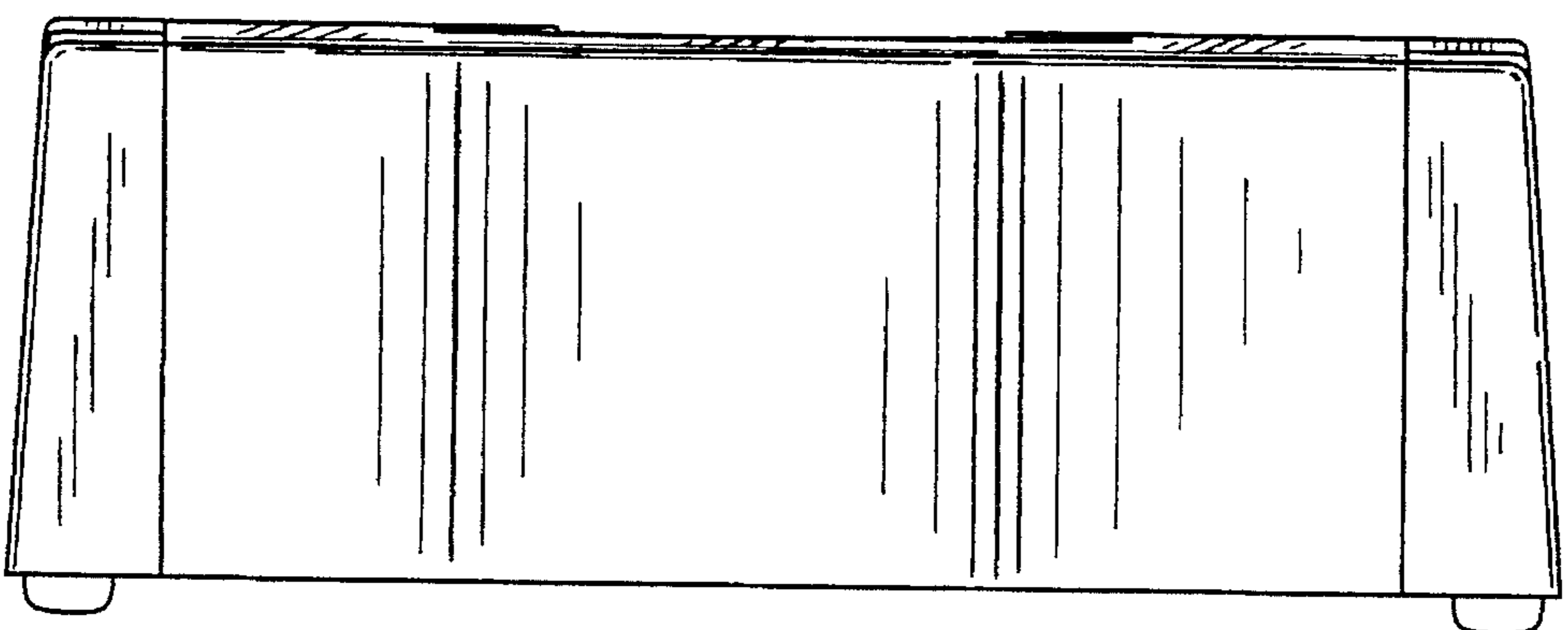

FIG. 10

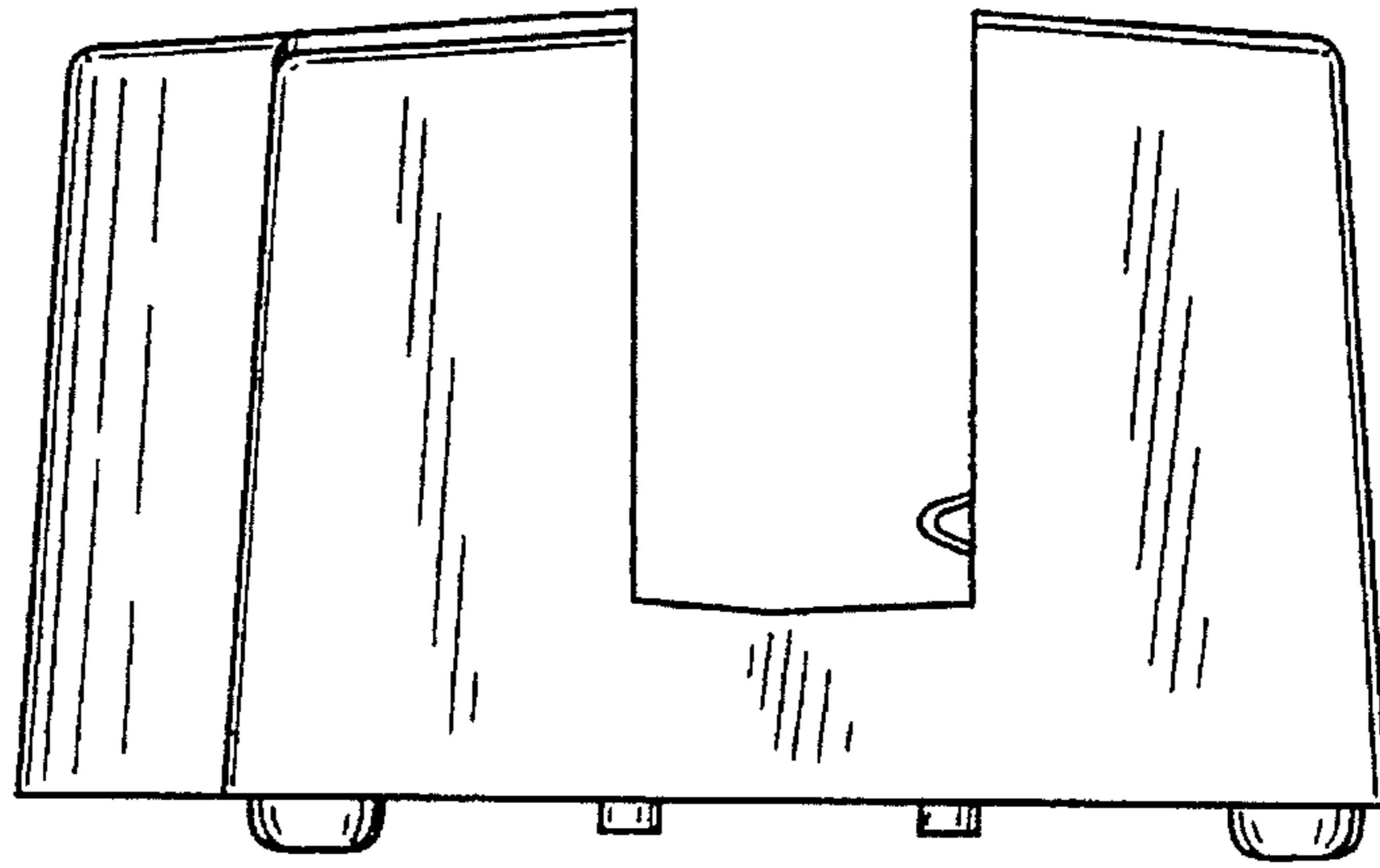

FIG. 11

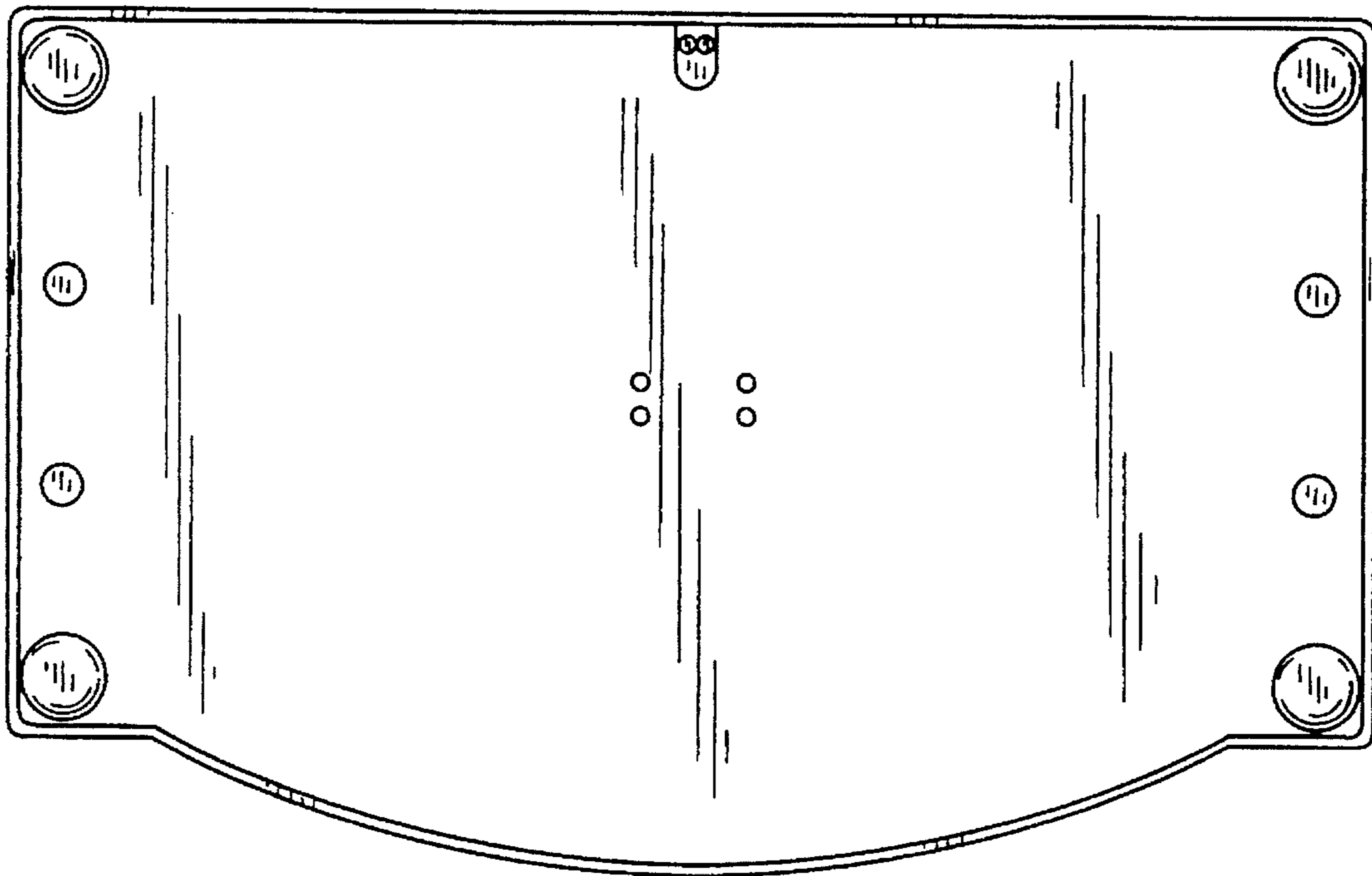

FIG. 12

