



US00D370257S

United States Patent [19] Christopher

[11] Patent Number: **Des. 370,257**

[45] Date of Patent: ****May 28, 1996**

[54] **OCULAR SOLUTION APPLICATOR**

[76] Inventor: **Warren S. Christopher**, 3704 Rosanne La., Modesto, Calif. 95356

[**] Term: **14 Years**

[21] Appl. No.: **33,250**

[22] Filed: **Jan. 9, 1995**

5,007,905	4/1991	Bauer	604/295
5,030,214	7/1991	Spector	604/301
5,037,406	8/1991	Smith et al.	604/301

FOREIGN PATENT DOCUMENTS

0953240	12/1949	France	604/295
7706190	3/1977	France	
2698541	6/1994	France	604/295
0533948	2/1941	United Kingdom	604/300

OTHER PUBLICATIONS

Aerosol Age—Valois Advertisement—inside back cover Dec. 1980.

Primary Examiner—Louis S. Zarfaz
Assistant Examiner—Frank Martinez
Attorney, Agent, or Firm—Haverstock & Associates

Related U.S. Application Data

[63] Continuation-in-part of Ser. No. 4,275, Feb. 1, 1993.
 [52] U.S. Cl. **D24/120**; 604/294; D24/110
 [58] Field of Search D9/338, 447; D24/120, D24/119, 115, 110, 113; 604/294, 295, 296, 300, 301, 289, 297, 298, 302; 128/845, 883, 884; 222/211

[57] **CLAIM**

The ornamental design for an ocular solution applicator, as shown and described.

References Cited

U.S. PATENT DOCUMENTS

1,603,727	10/1926	Vilas	604/301	X
2,524,720	10/1950	Watrous	604/296	
2,826,194	3/1958	Golden	128/173	
3,170,462	2/1965	Hall	128/173	
4,052,985	10/1977	Coleman et al.	128/173	
4,733,802	3/1988	Sheldon	222/181	
4,946,452	8/1990	Py	604/301	
4,968,310	11/1990	Menchel et al.	604/295	
4,981,479	1/1991	Py	604/302	

DESCRIPTION

FIG. 1 is a front, perspective view;
FIG. 2 is a side view;
FIG. 3 is a side, cross-sectional view;
FIG. 4 is a top view;
FIG. 5 is a bottom view; and,
FIG. 6 is a back, perspective view.

1 Claim, 2 Drawing Sheets

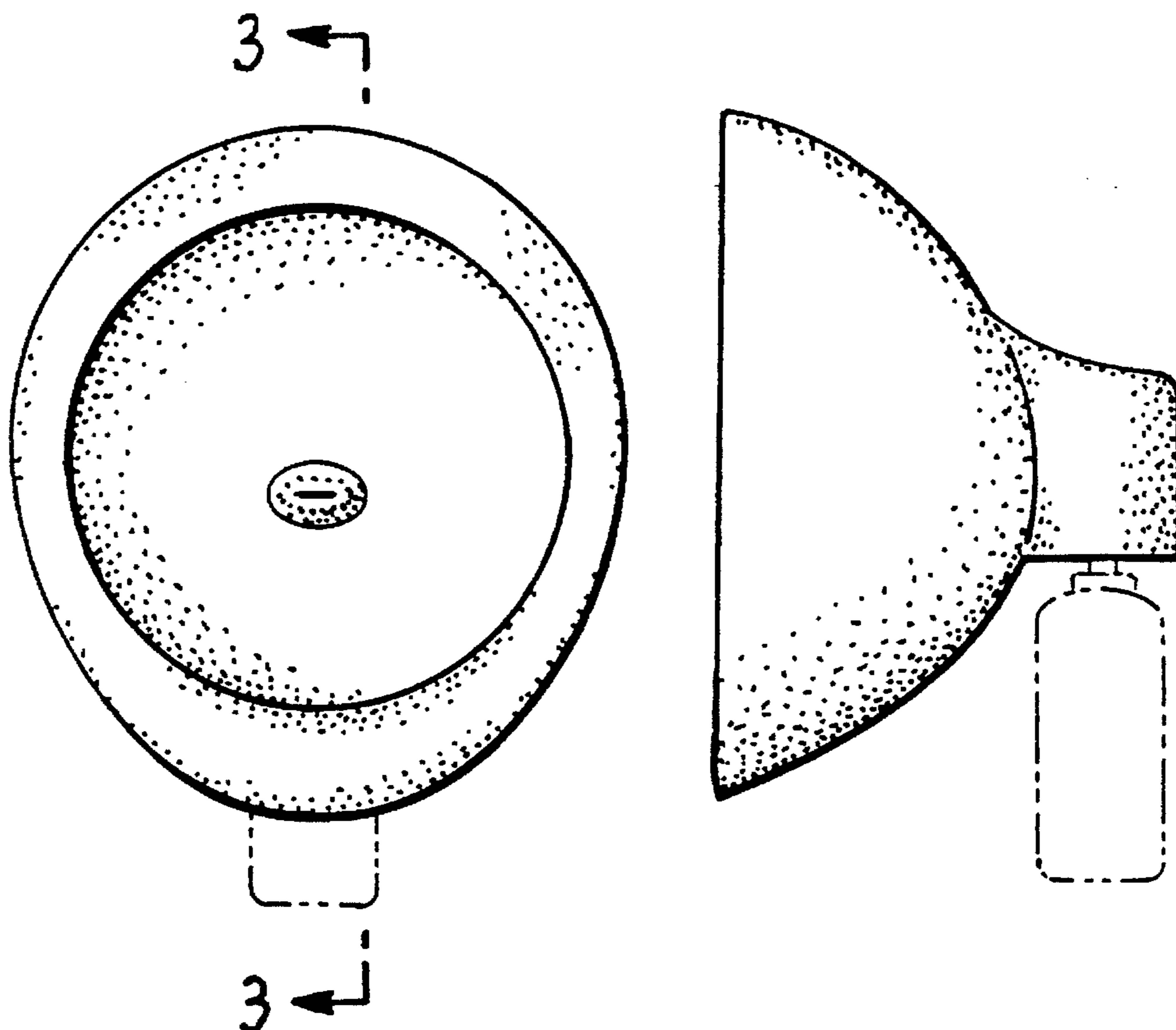

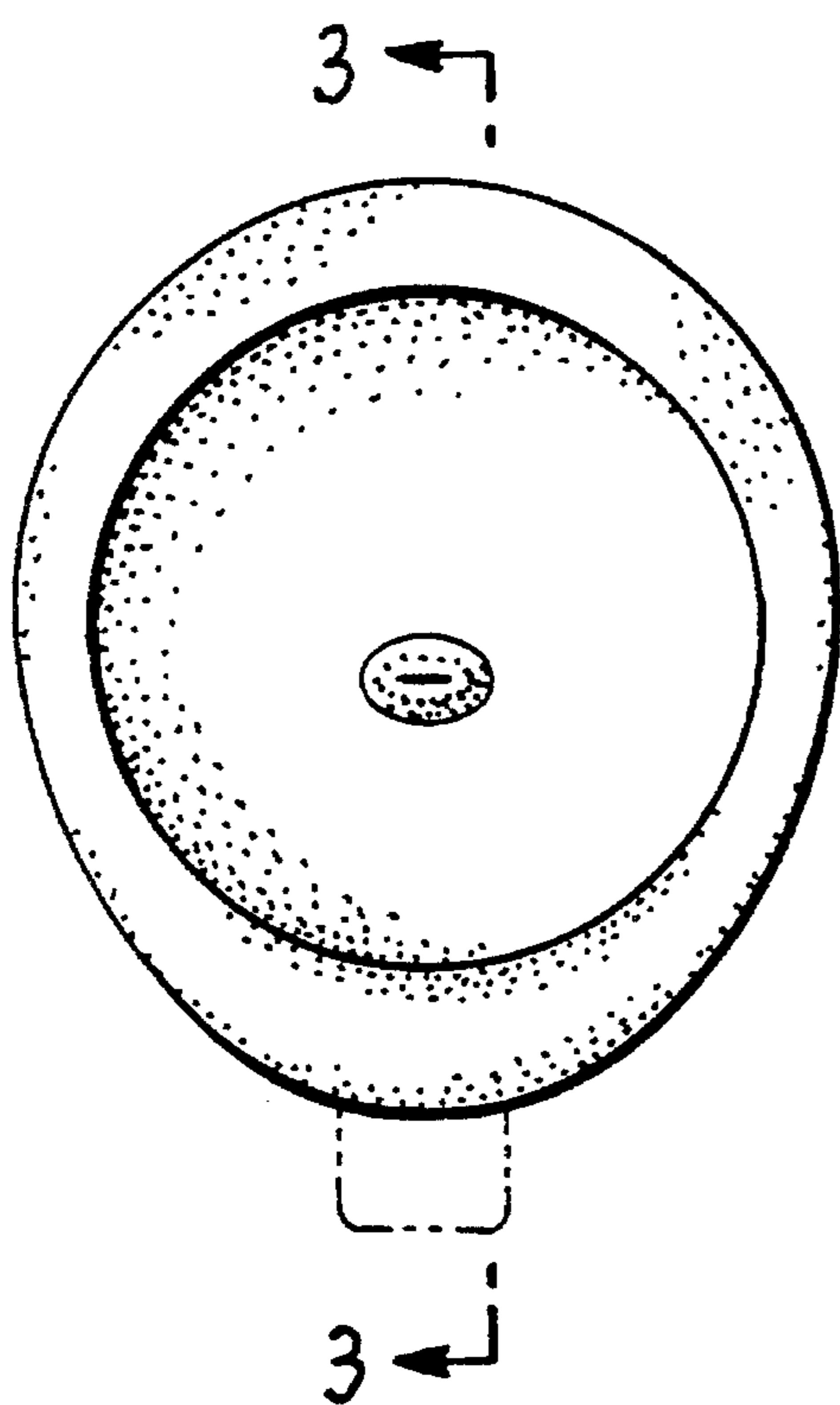

FIG. 1

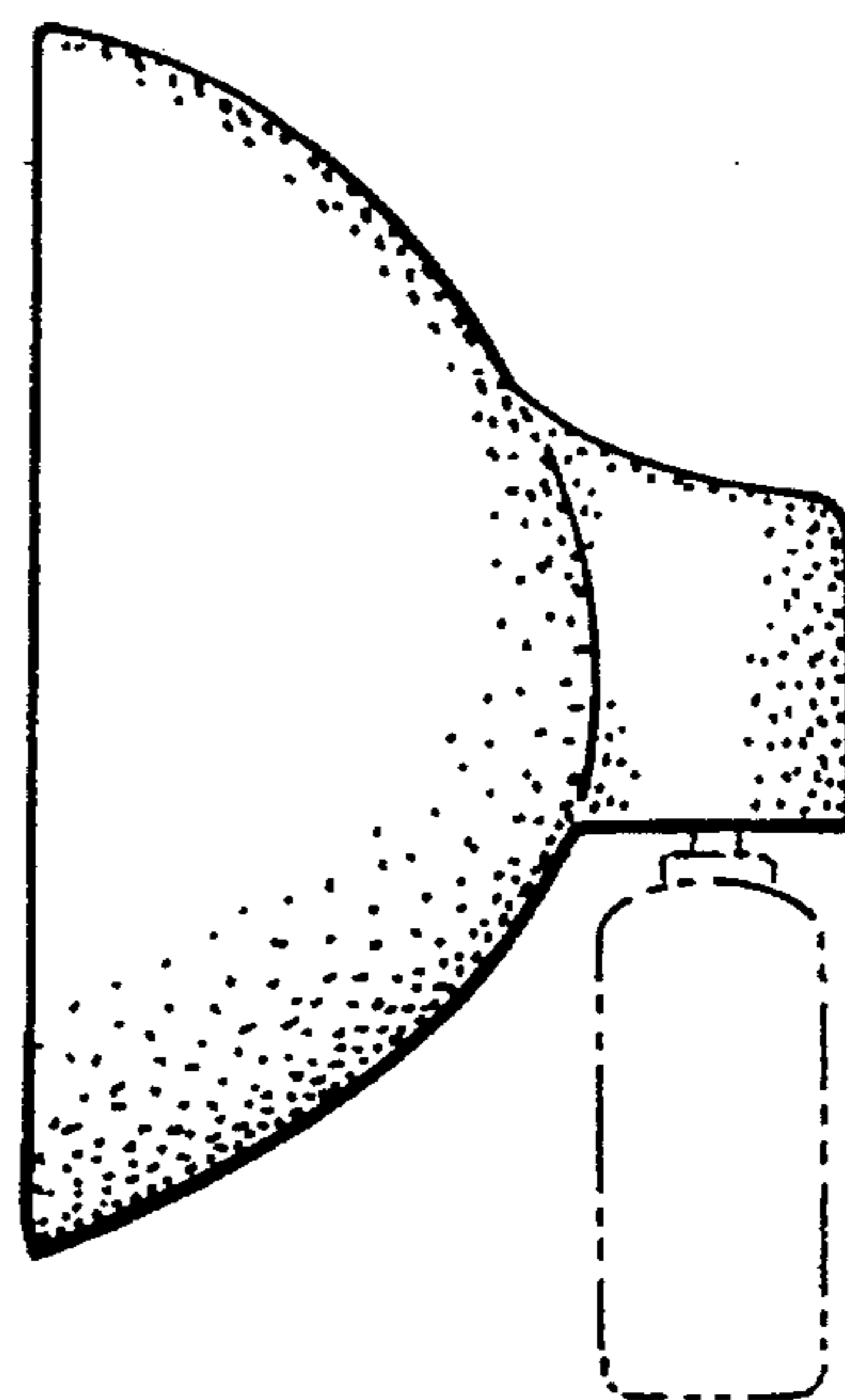

FIG. 2

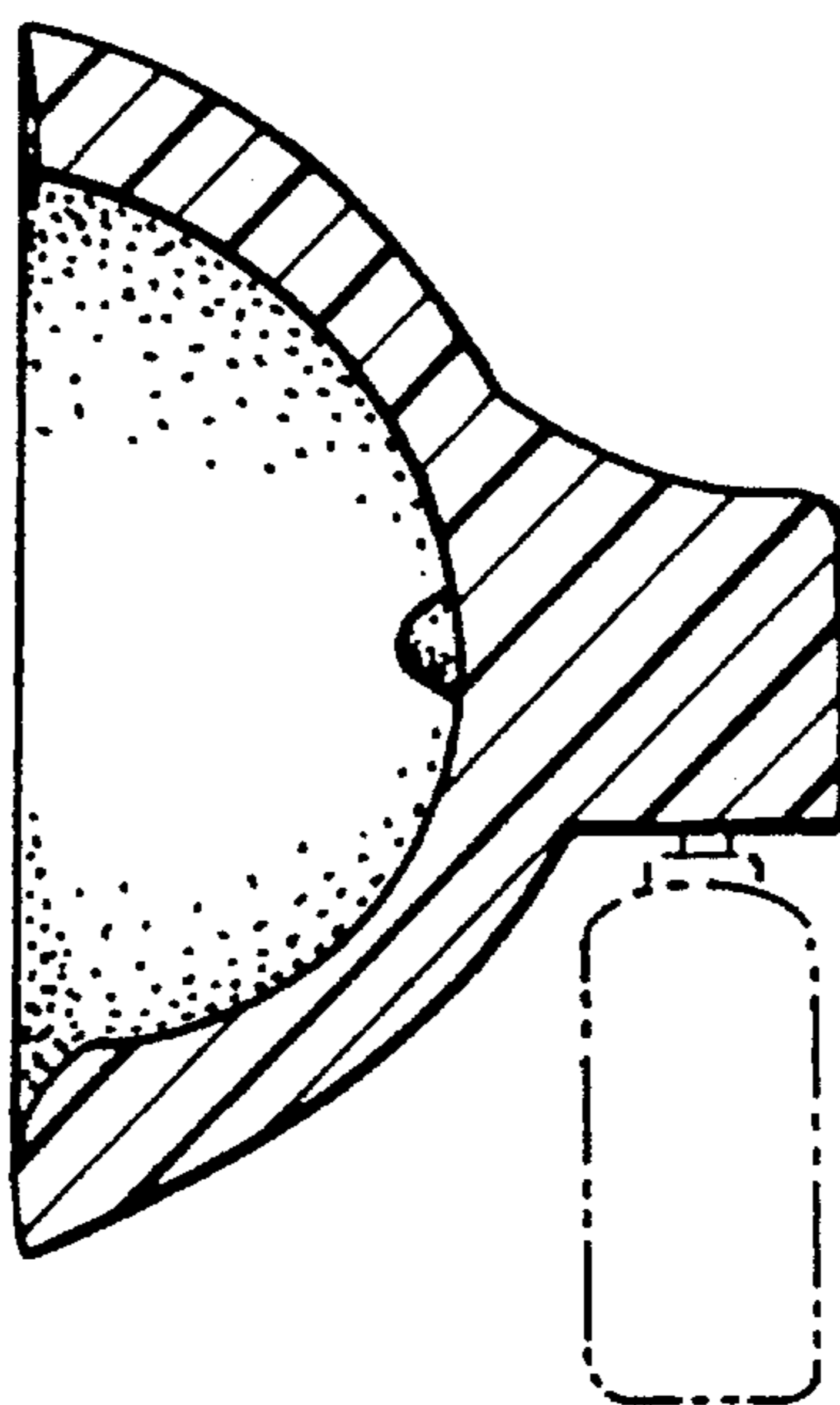

FIG. 3

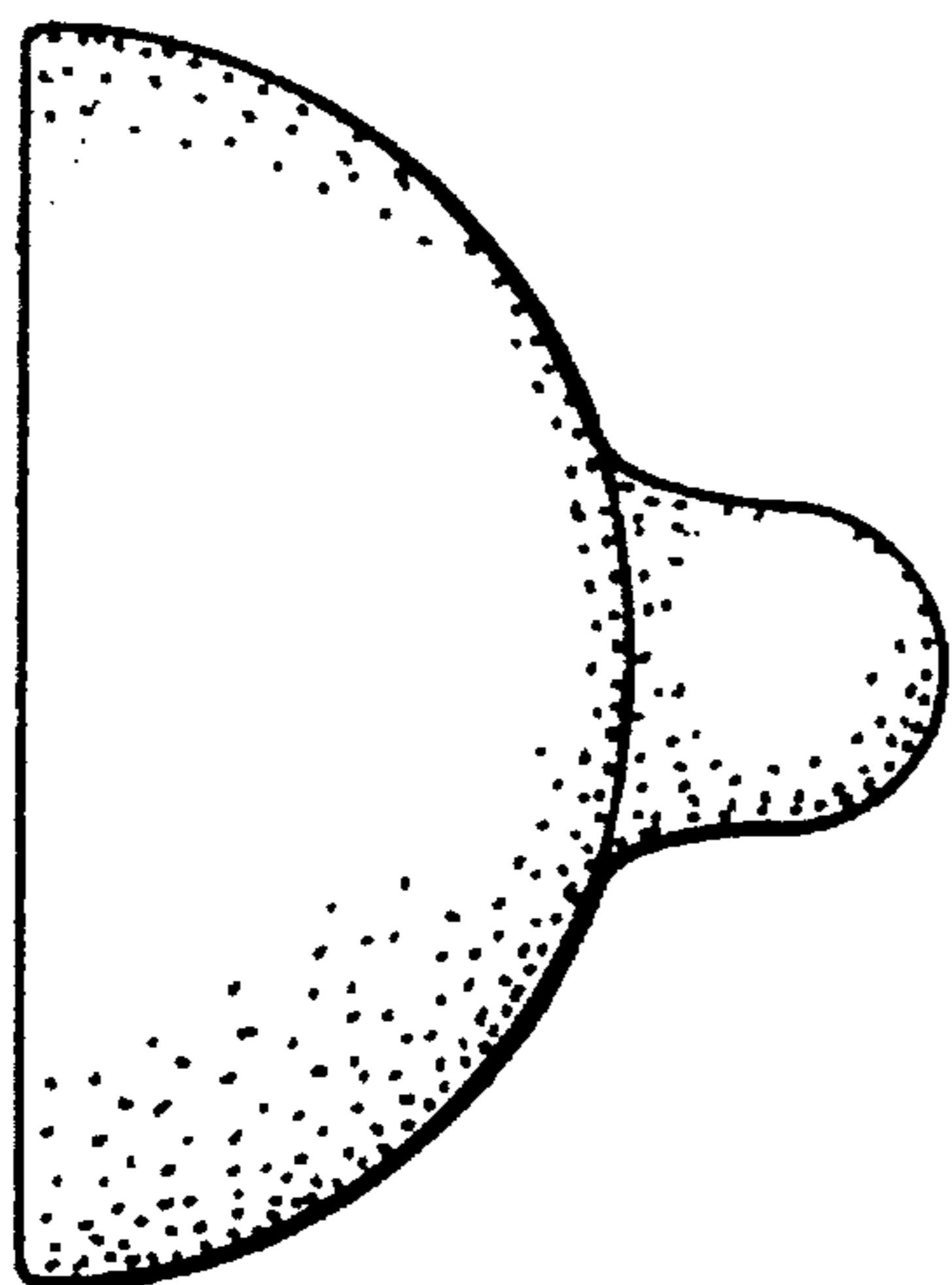

FIG. 4

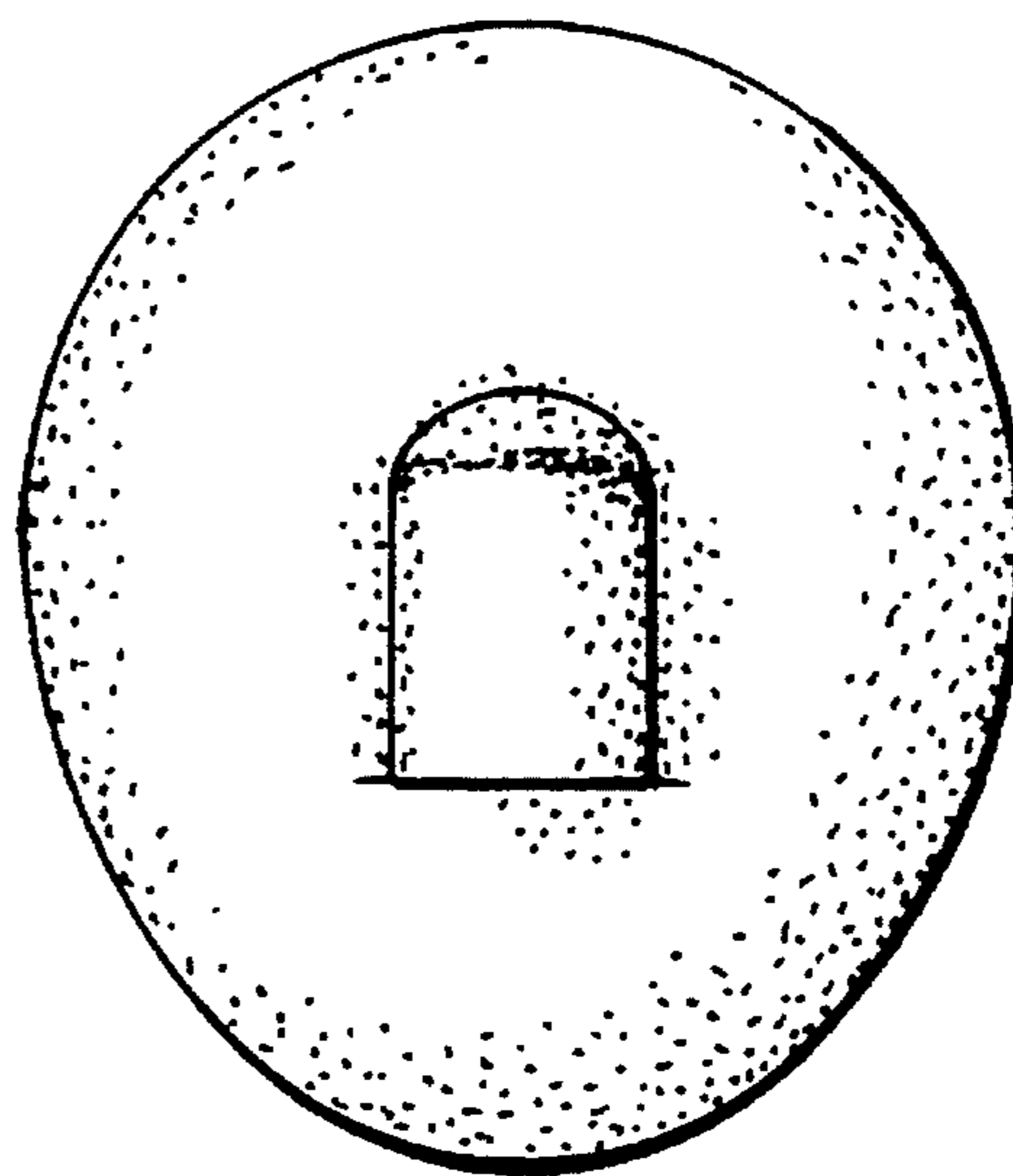

FIG. 6

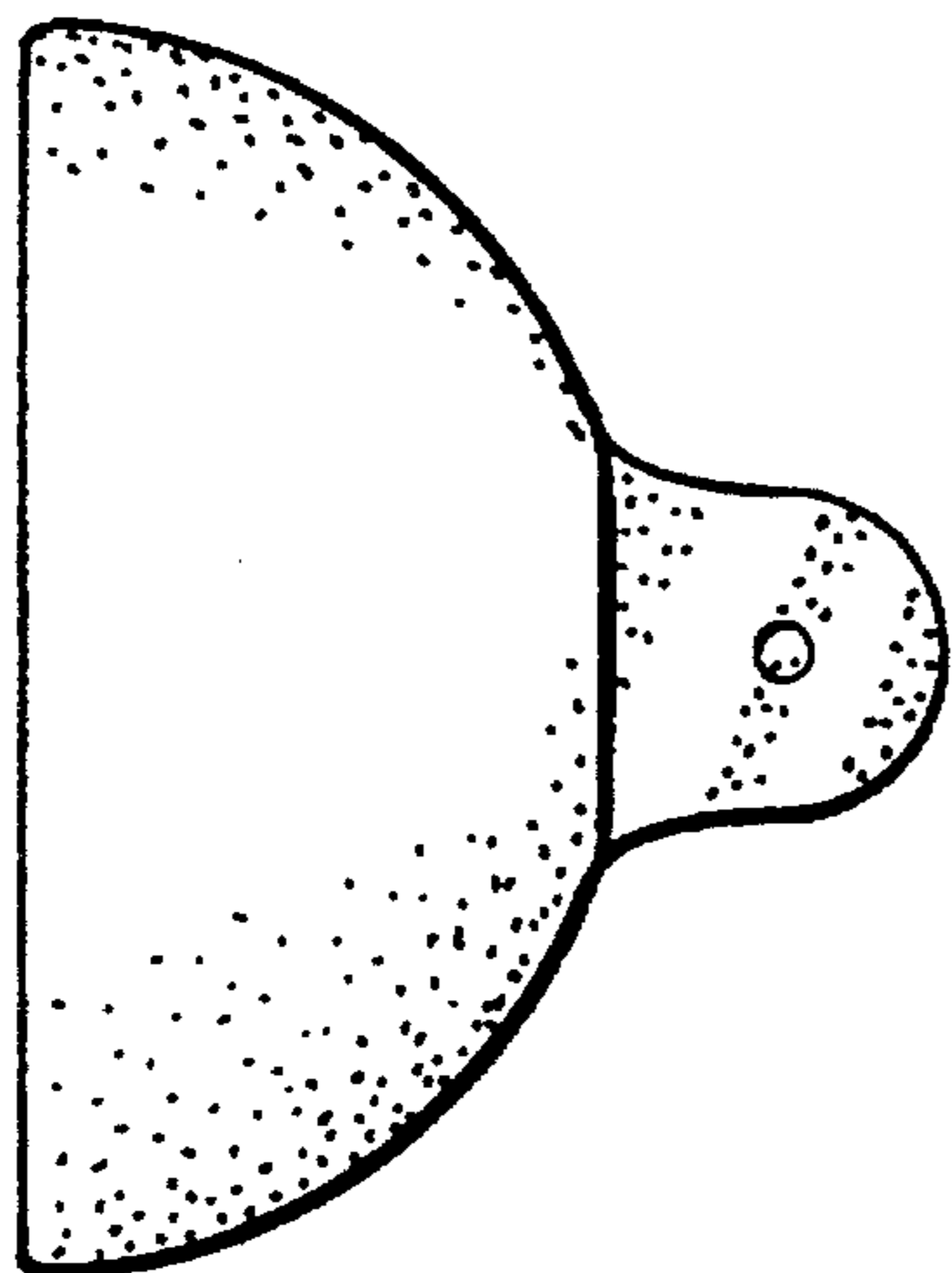

FIG. 5