



US00D370149S

# United States Patent [19]

[11] Patent Number: **Des. 370,149**

Stratton

[45] Date of Patent: **\*\*May 28, 1996**

[54] **PLAY PEN COVER**

[76] Inventor: **Amy M. Stratton**, 1203 E. Alfred St.,  
Tavares, Fla. 32778

[\*\*] Term: **14 Years**

4,837,875	6/1989	Shamie et al.	5/99 C
4,852,309	8/1989	Stamp, Sr.	D25/56 X
4,945,584	8/1990	Lamantia	5/97
5,025,821	6/1991	Page et al.	135/112
5,161,269	11/1992	McLean et al.	5/414
5,446,934	9/1995	Frazier	5/655

[21] Appl. No.: **34,361**

[22] Filed: **Feb. 2, 1995**

[52] U.S. Cl. .... **D6/610; D6/331**

[58] Field of Search ..... D6/331, 333, 382,  
D6/389-391, 610; 5/93.1-93.2, 97, 99.1,  
100, 113, 413-416, 418; D30/108-109,  
114-117; D25/56

*Primary Examiner*—Alan P. Douglas

*Assistant Examiner*—Stacia Sinuik

[57] **CLAIM**

The ornamental design for the play pen cover, as shown and described.

### DESCRIPTION

FIG. 1 is a front elevational view of the play pen cover showing my new design;

FIG. 2 is a rear elevational view thereof;

FIG. 3 is a left side elevational view thereof;

FIG. 4 is a right side elevational view thereof;

FIG. 5 is a top plan view thereof;

FIG. 6 is a bottom plan view thereof; and,

FIG. 7 is an upper and right perspective view thereof in a position of use, the broken line showing of a play pen for illustrative purposes only and forming no part of the claimed design.

[56] **References Cited**

#### U.S. PATENT DOCUMENTS

D. 238,498	1/1976	Barr	D30/108
D. 257,299	10/1980	Cone	D6/13
1,418,541	6/1922	Demlinger	5/97
2,498,203	2/1950	Fischer	5/99.1 X
2,820,468	1/1958	Park et al.	5/97 X
3,334,442	10/1967	Andrews et al.	5/97
3,878,570	4/1975	Donnelly	5/97
4,043,349	8/1977	Gays et al.	5/414
4,694,516	9/1987	Overman, Sr. et al.	5/93 R
4,790,340	12/1988	Mahoney	135/90

**1 Claim, 4 Drawing Sheets**

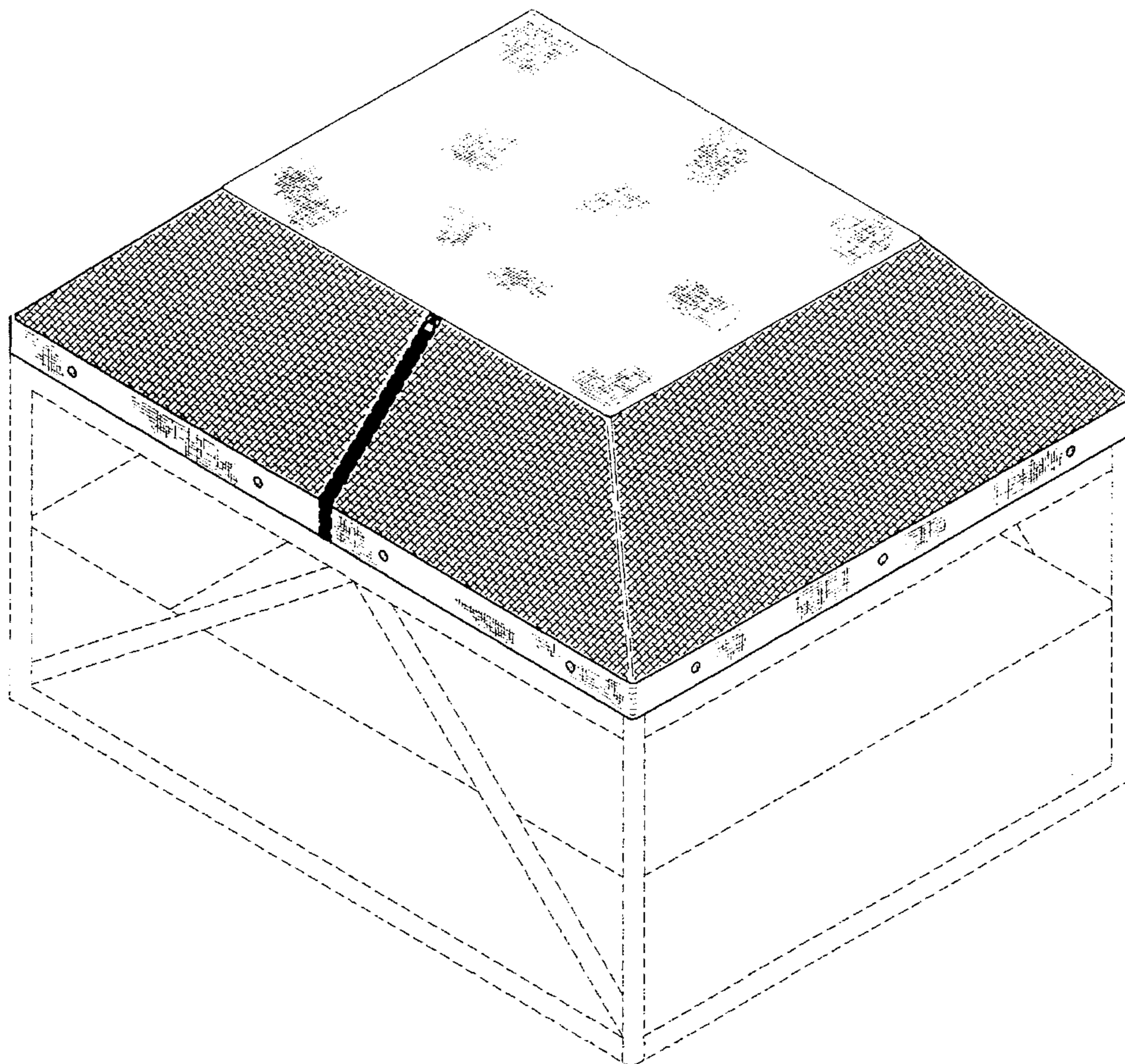

FIG. 1

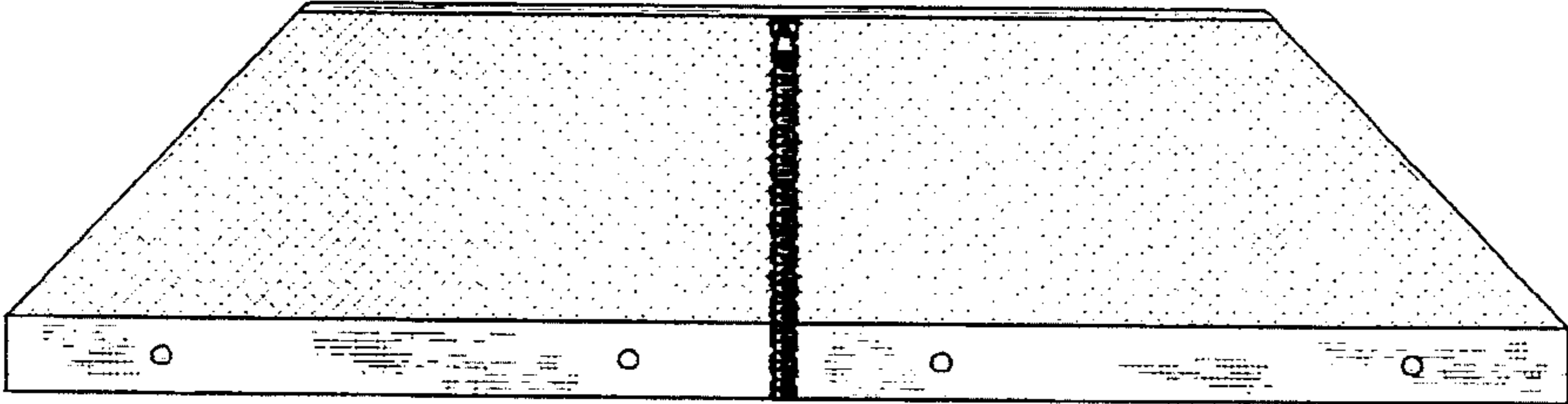
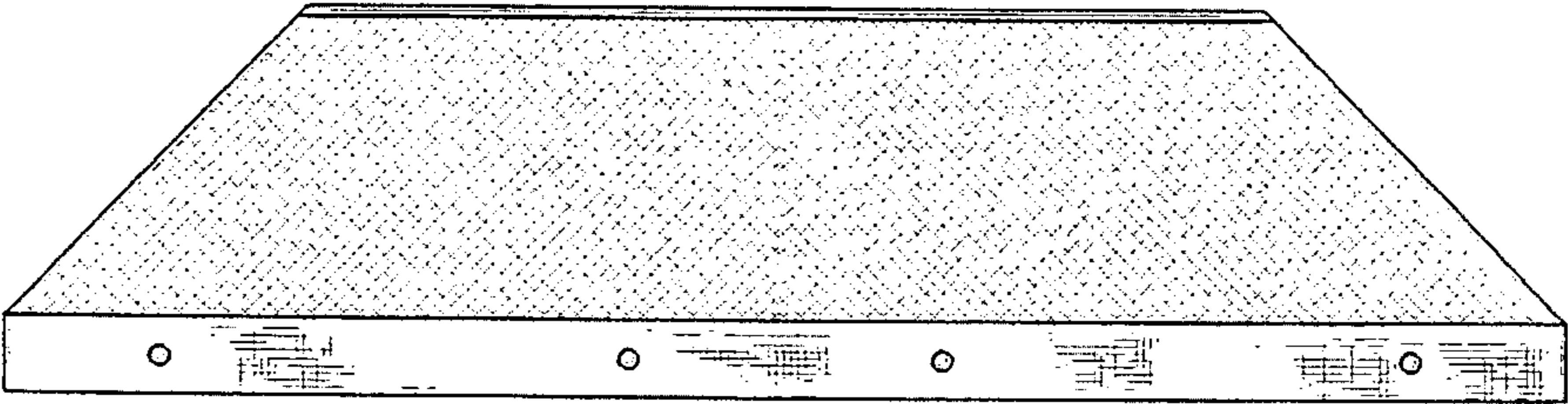
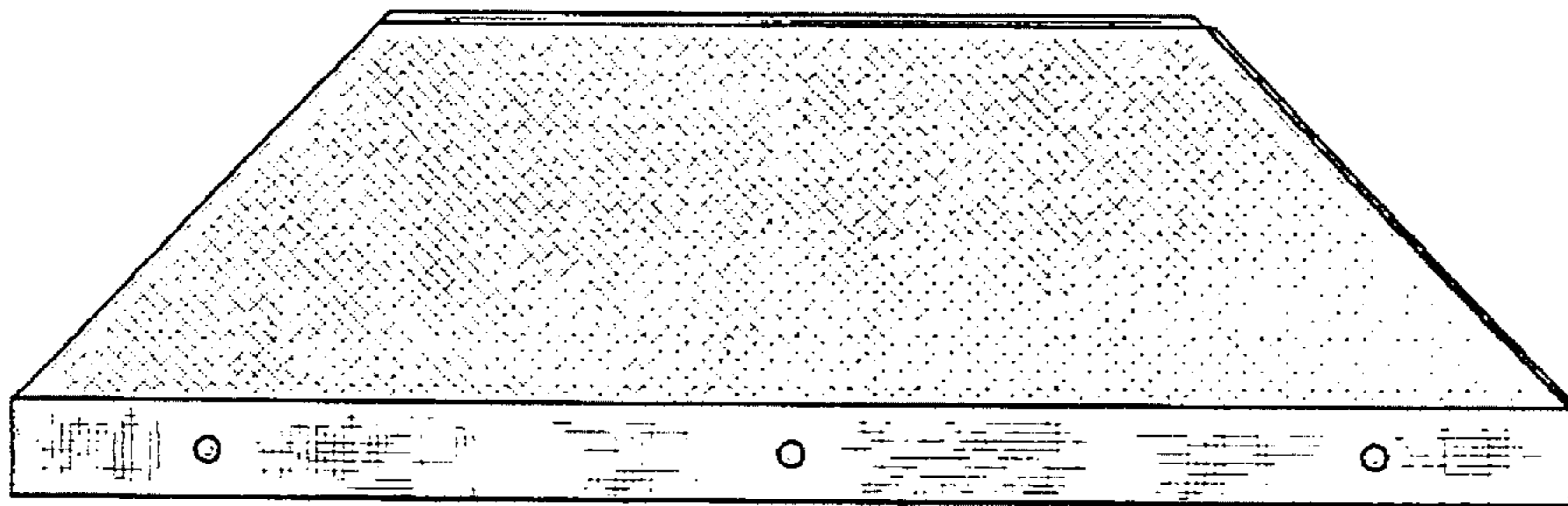

FIG. 2





*FIG. 3*



*FIG. 4*

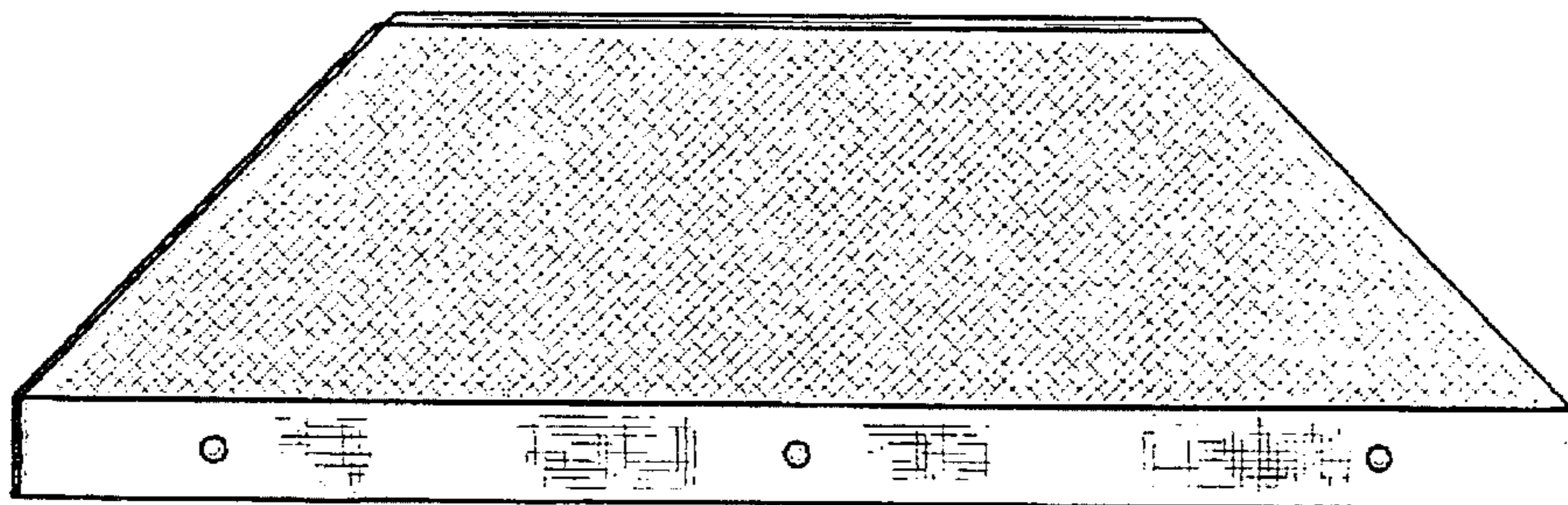

FIG. 5

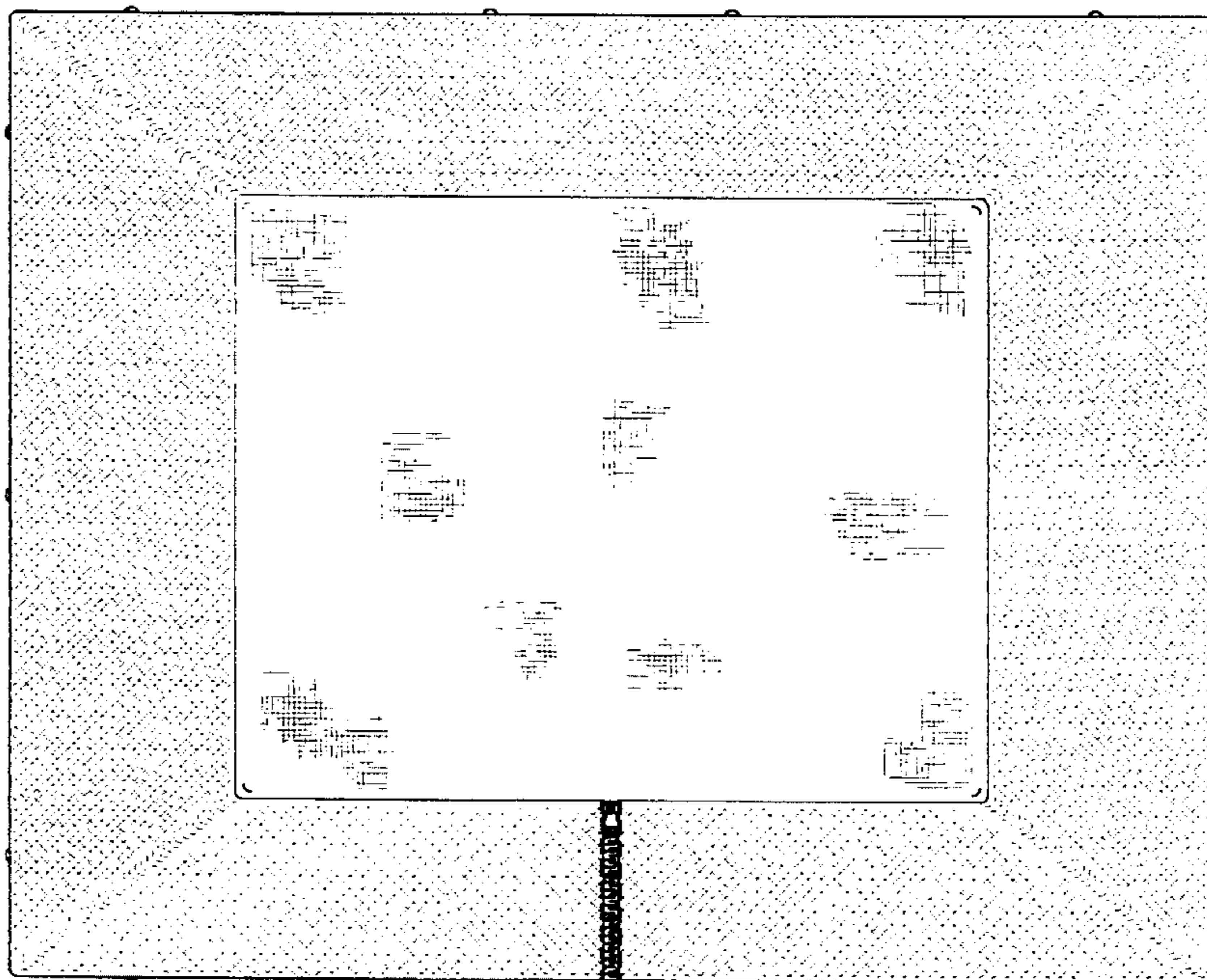

FIG. 6

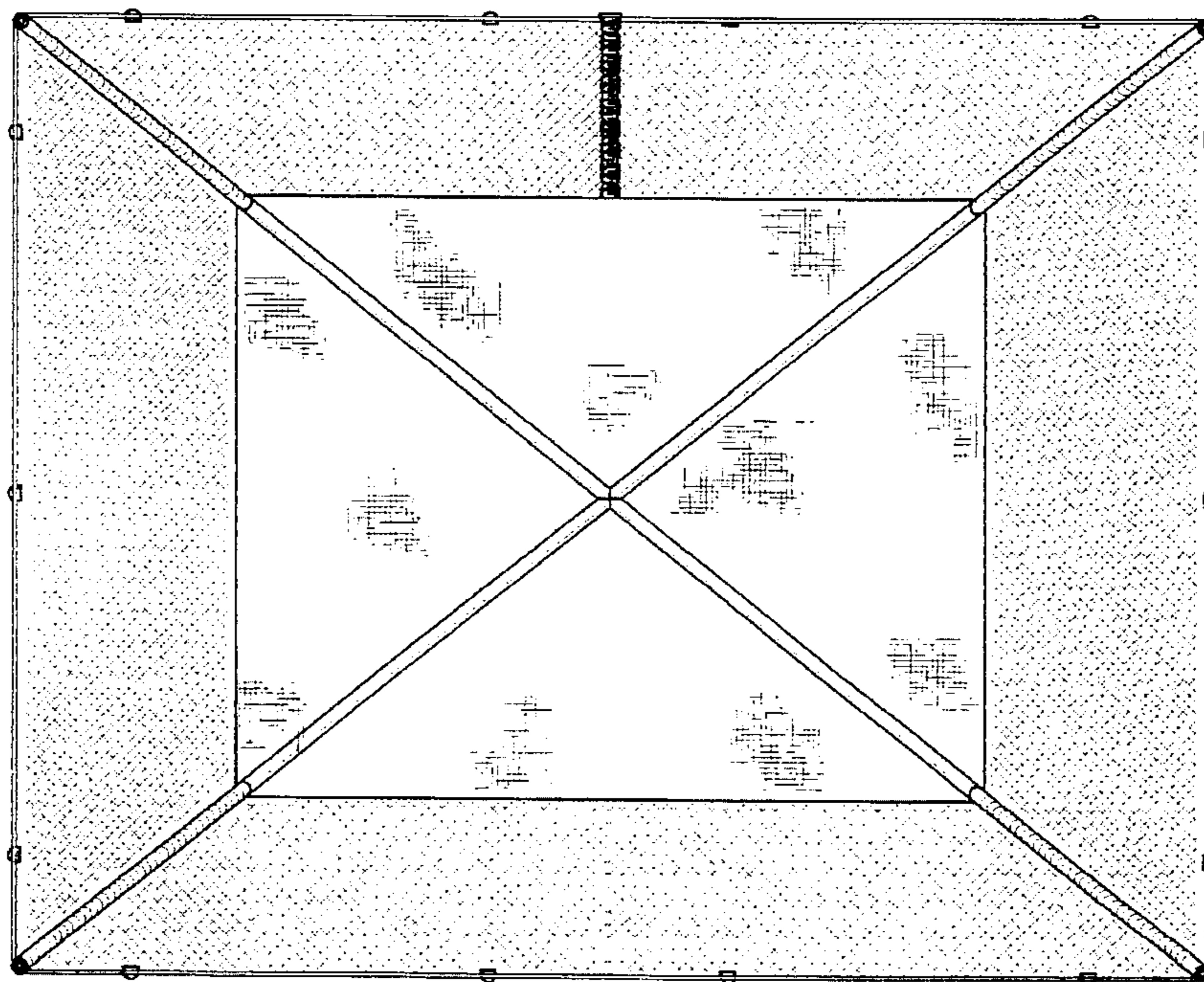



FIG. 7

