



US00D370084S

United States Patent [19]
Cassai

[11] **Patent Number: Des. 370,084**
[45] **Date of Patent: **May 21, 1996**

[54] **ADJUSTABLE ANGLE WAND FOR COSMETIC BOTTLE/CAP APPLICATORS**

[76] Inventor: **Henry J. Cassai**, P.O. Box 140169, Howard Beach, N.Y. 11414

[**] Term: **14 Years**

[21] Appl. No.: **34,426**

[22] Filed: **Feb. 6, 1995**

Related U.S. Application Data

[62] Division of Ser. No. 786,905, Oct. 25, 1991, Pat. No. Des. 355,503.

[52] **U.S. Cl.** **D28/7**

[58] **Field of Search** **D28/7, 76, 77; 132/216, 218, 317, 320; 401/118-130; D4/116, 121, 128, 138**

[56] **References Cited**

U.S. PATENT DOCUMENTS

D. 164,504	9/1951	Klugmann	D28/7	X
D. 282,107	1/1986	Cassai et al.	D28/7	
D. 317,061	5/1991	Cassai et al.	D28/7	
4,165,755	8/1979	Cassai	D28/7	X
4,428,388	1/1994	Cassai et al.	D28/7	X

Primary Examiner—Ted Shooman

Assistant Examiner—C. Tuttle

[57] **CLAIM**

The ornamental design for an adjustable angle wand for cosmetic bottle/cap applicators, as shown and described.

DESCRIPTION

FIG. 1 is an exploded side elevational view of an adjustable angle wand for cosmetic bottle/cap applicators showing my new design, its opposite side being the same;

FIG. 2 is an exploded front elevational view of the design, its rear view being the same;

FIG. 3 is an exploded top plan view of the design, with the upper extension wand segment/brush receptacle in an alternative position;

FIG. 4 is an assembled side elevational view of the design, its opposite side being the same;

FIG. 5 is a front elevational view of the design, its rear view being the same;

FIG. 6 is a top plan view of the design;

FIG. 7 is a top plan view of the design with the upper extension wand segment/brush receptacle adjusted to an alternative position;

FIG. 8 is an exploded side elevational view of the design, shown partially in section for clarity of illustration;

FIG. 9 is an assembled side elevational view of the design in partial section;

FIG. 10 is a side elevational view of the design in partial section with the extension wand segment/brush receptacle adjusted to an alternative position;

FIG. 11 is a side elevational view of the design in partial section with the extension wand segment/brush receptacle adjusted to an alternative position;

FIG. 12 is a side elevational view of the design with the extension wand segment/brush receptacle adjusted to an alternative position;

FIG. 13 is a side elevational view of the design with the extension wand segment/brush receptacle adjusted to an alternative position;

FIG. 14 is an exploded front elevational view showing a second embodiment of my new design, its rear view being the same;

FIG. 15 is an exploded side elevational view of an adjustable angle wand for cosmetic bottle/cap applicators showing a third embodiment of my new design, its opposite side being the same;

FIG. 16 is an assembled side elevational view of the third embodiment, its opposite side being the same;

FIG. 17 is a side elevational view of an adjustable angle wand for cosmetic bottle/cap applicators showing a fourth embodiment of my new design, its opposite side being the same;

FIG. 18 is a side elevational view of an adjustable angle wand for cosmetic bottle/cap applicators showing a fifth embodiment of my new design, its opposite side being the same;

FIG. 19 is a front elevational view of the fifth embodiment, its rear view being the same;

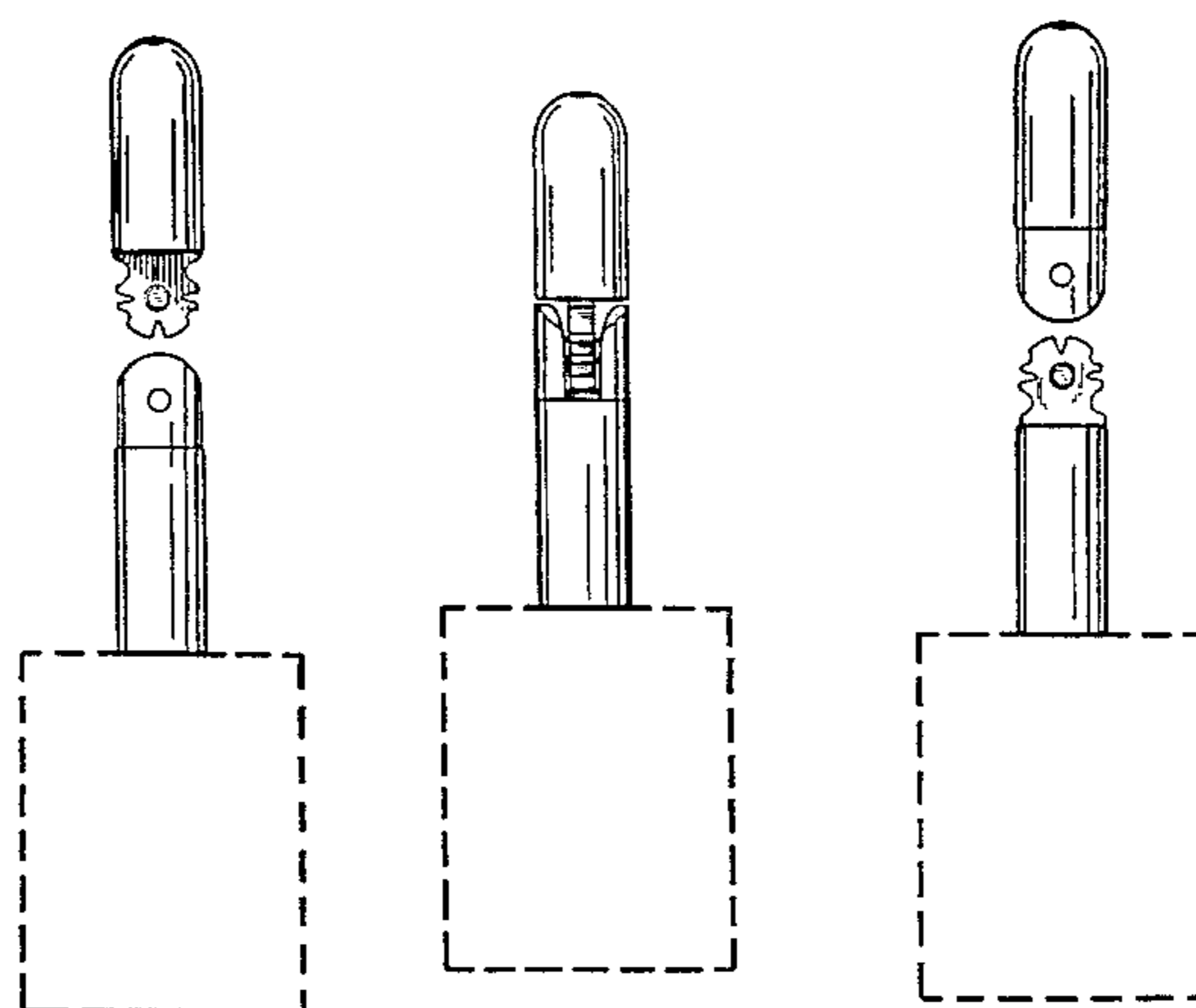

FIG. 20 is a side elevational view of an adjustable angle wand for cosmetic bottle/cap applicators showing a sixth embodiment of my new design its opposite side being the same;

FIG. 21 is a front elevational view of the sixth embodiment, its rear being the same;

FIG. 22 is an exploded side elevational view of an adjustable angle wand for cosmetic bottle/cap applicators showing a seventh embodiment of my new design, its opposite side being the same;

FIG. 23 is an assembled side elevational view of the seventh embodiment, its opposite side being the same;

FIG. 24 is a front elevational view of the seventh embodiment, its rear view being the same;

FIG. 25 is a side elevational view of an adjustable angle wand for cosmetic bottle/cap applicators showing an eighth embodiment of my new design, its opposite side being the same;

FIG. 26 is a front elevational view of the eighth embodiment, its rear view being the same;

FIG. 27 is a side elevational view of an adjustable angle wand for cosmetic bottle/cap applicators showing a ninth embodiment of my new design, its opposite side being the same;

FIG. 28 is a front elevational view of the ninth embodiment, its rear view being the same;

FIG. 29 is an exploded side elevational view of an adjustable angle wand for cosmetic bottle/cap applicators showing a tenth embodiment of my new design, its opposite side being the same; and,

FIG. 30 is an exploded front elevational view of the tenth embodiment, its rear view being the same.

The several partially disclosed embodiments are identical to the first disclosed embodiment except for the modifications in the portions shown.

The broken line showing of the cap is for illustrative purposes only and forms no part of the claimed design.

1 Claim, 7 Drawing Sheets

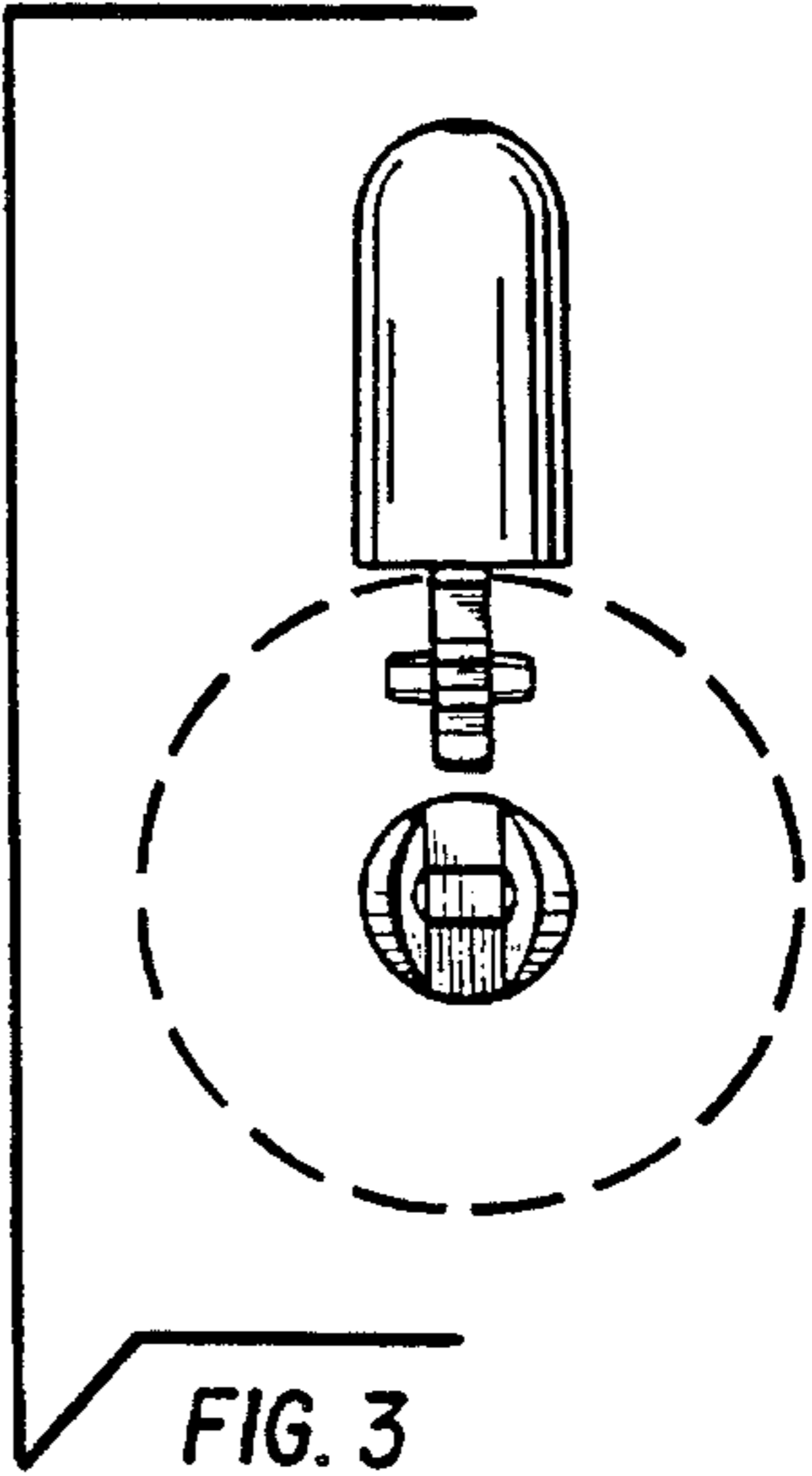
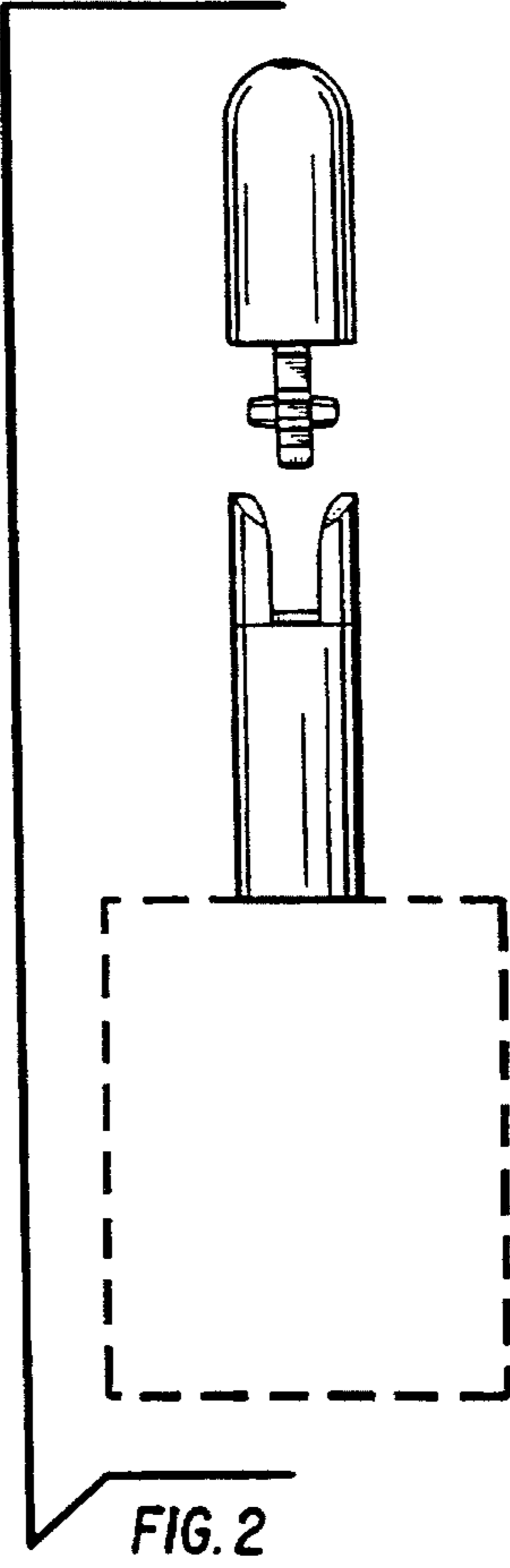
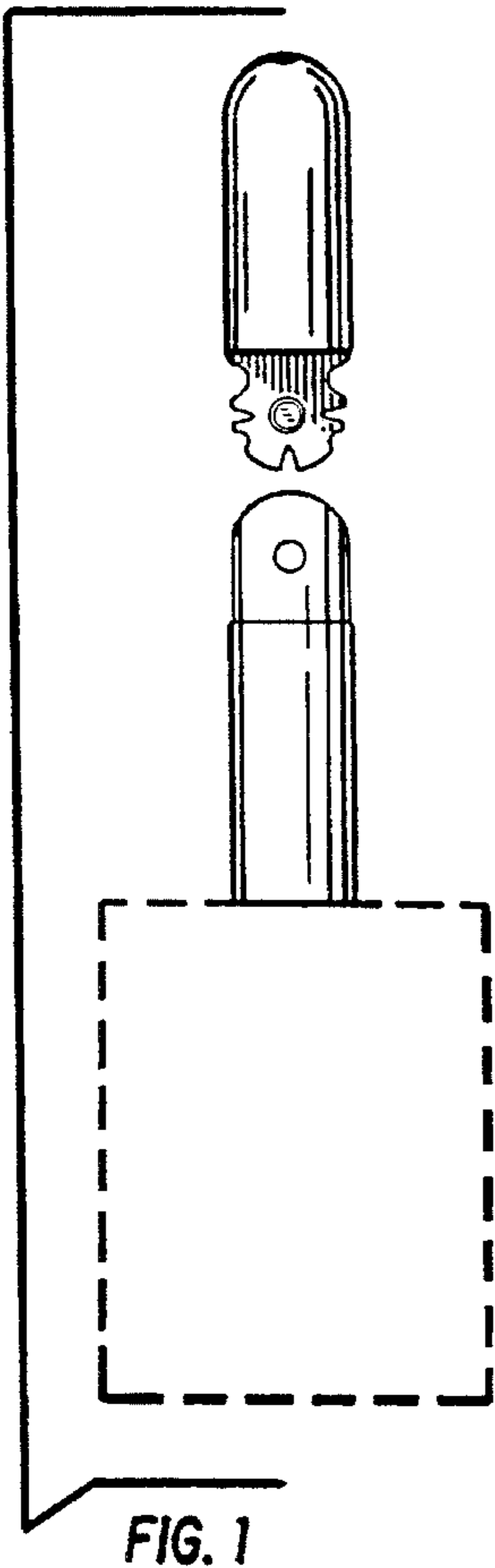

FIG. 1

FIG. 2

FIG. 3

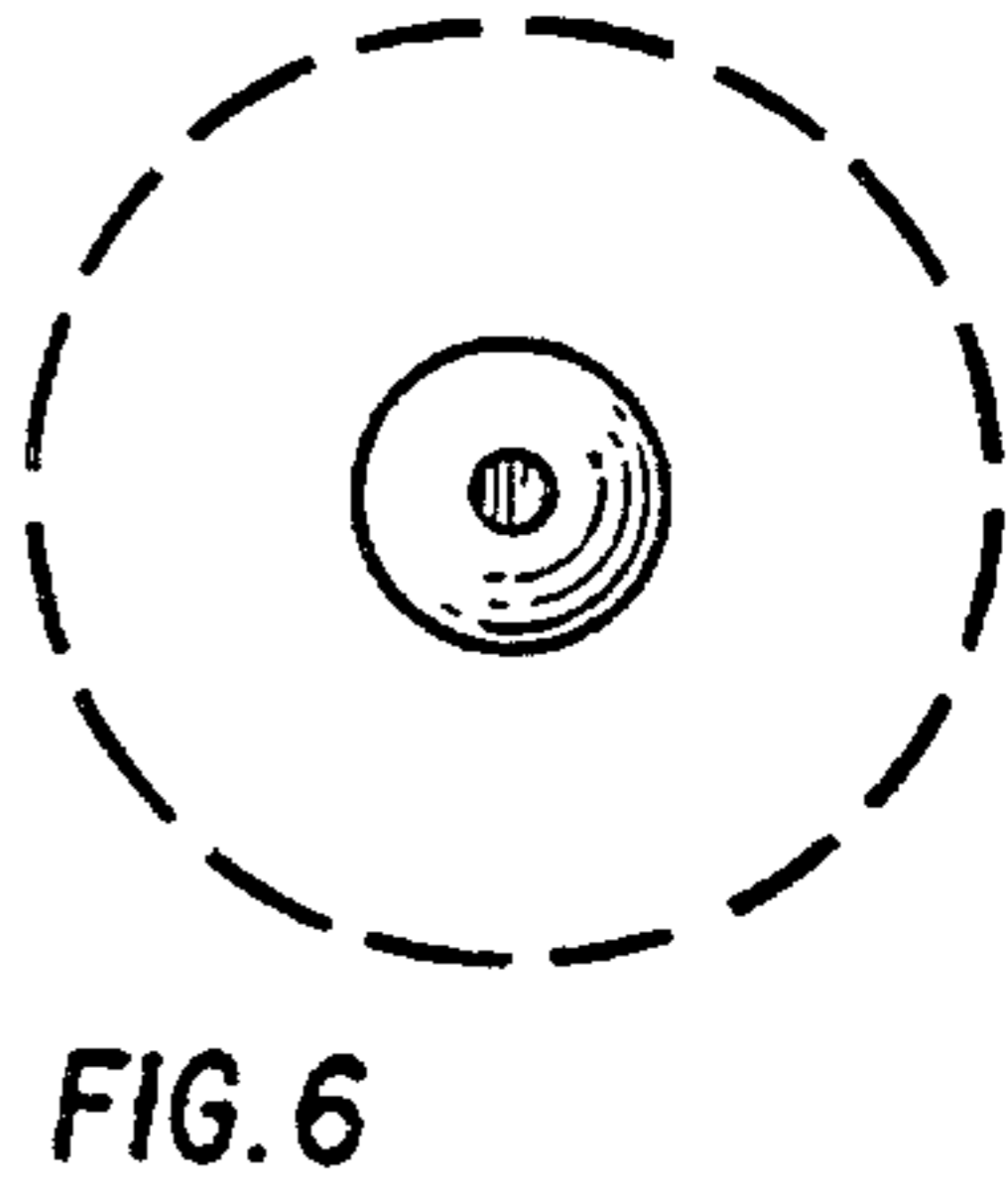
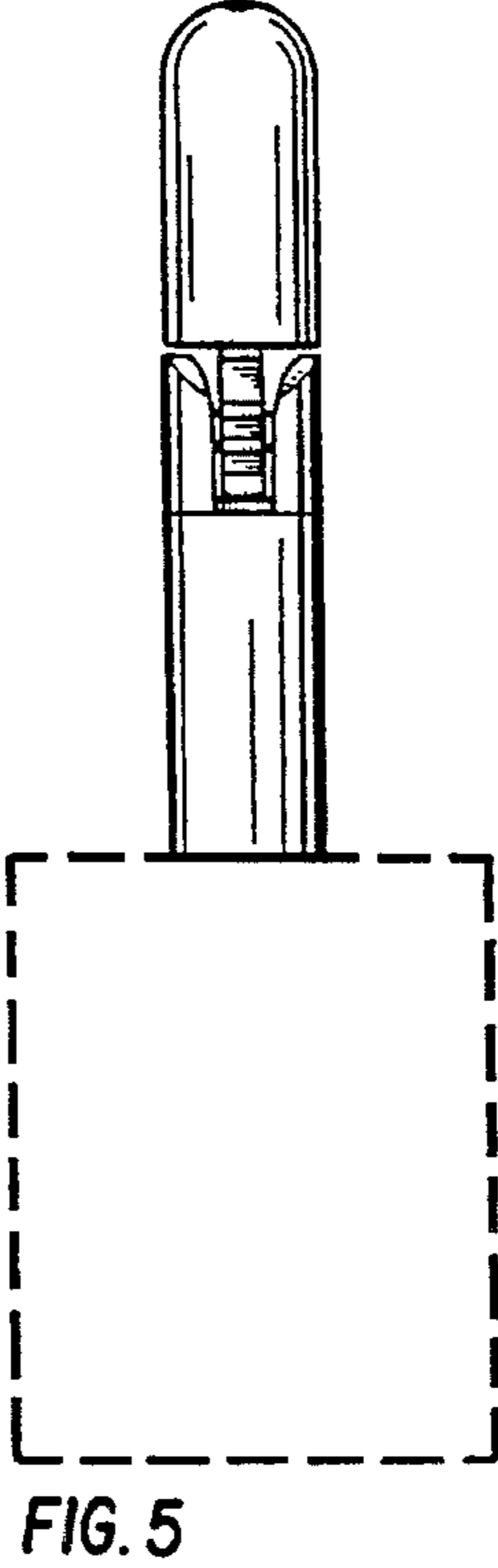
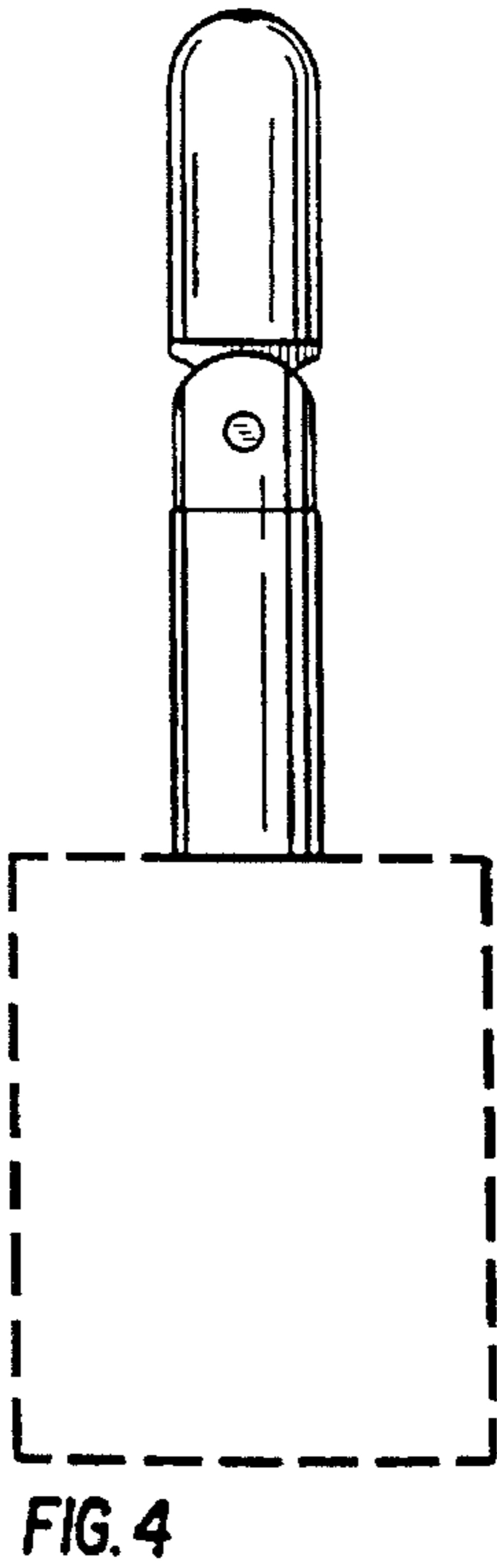

FIG. 4

FIG. 5

FIG. 6

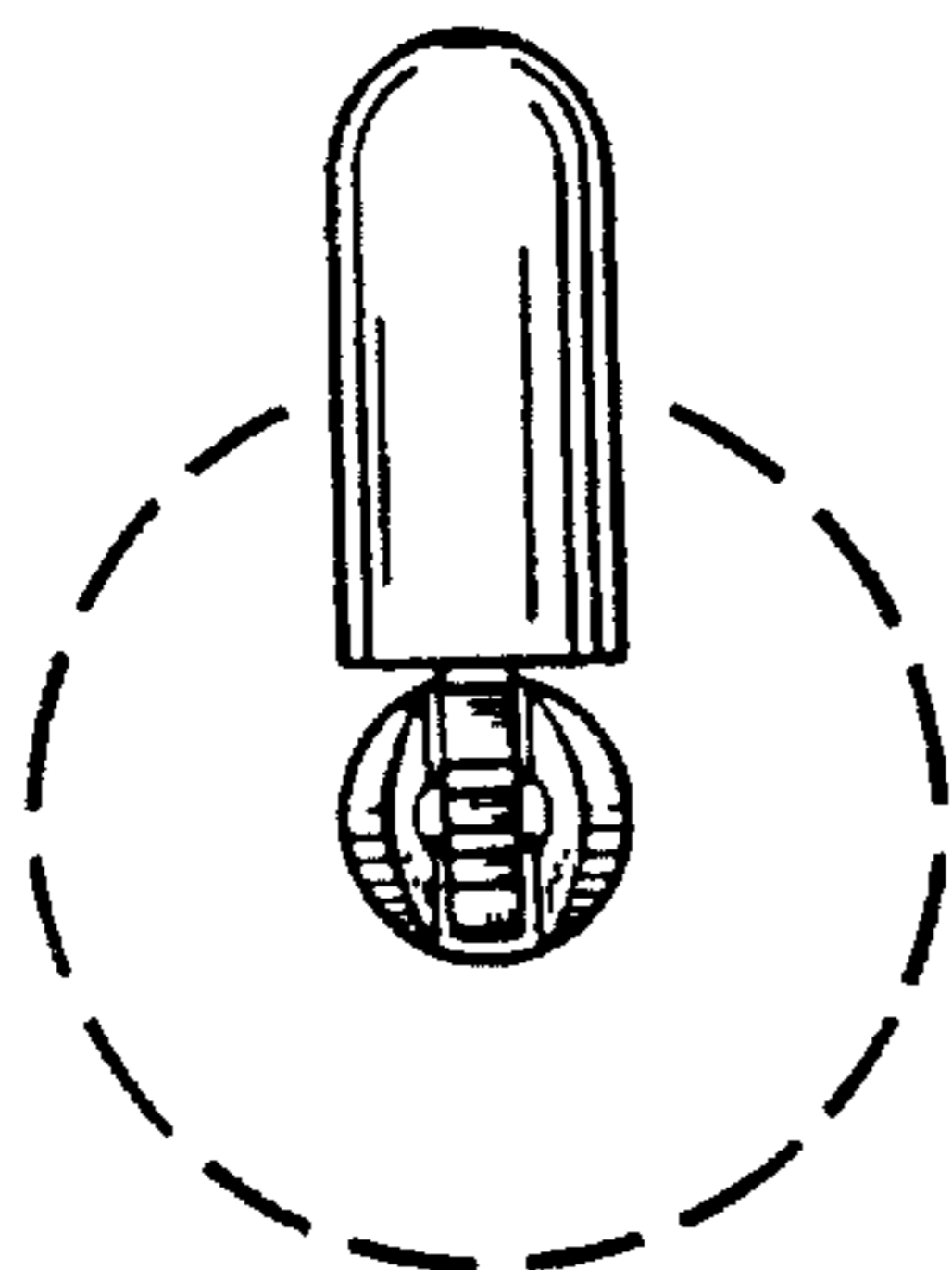

FIG. 7

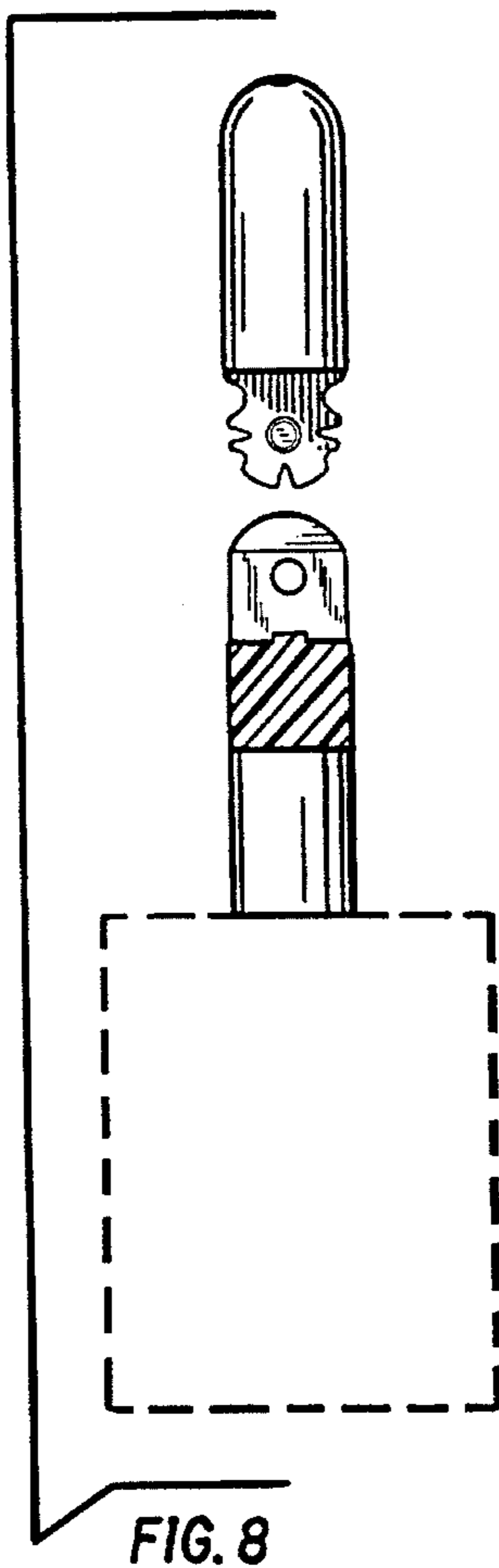

FIG. 8

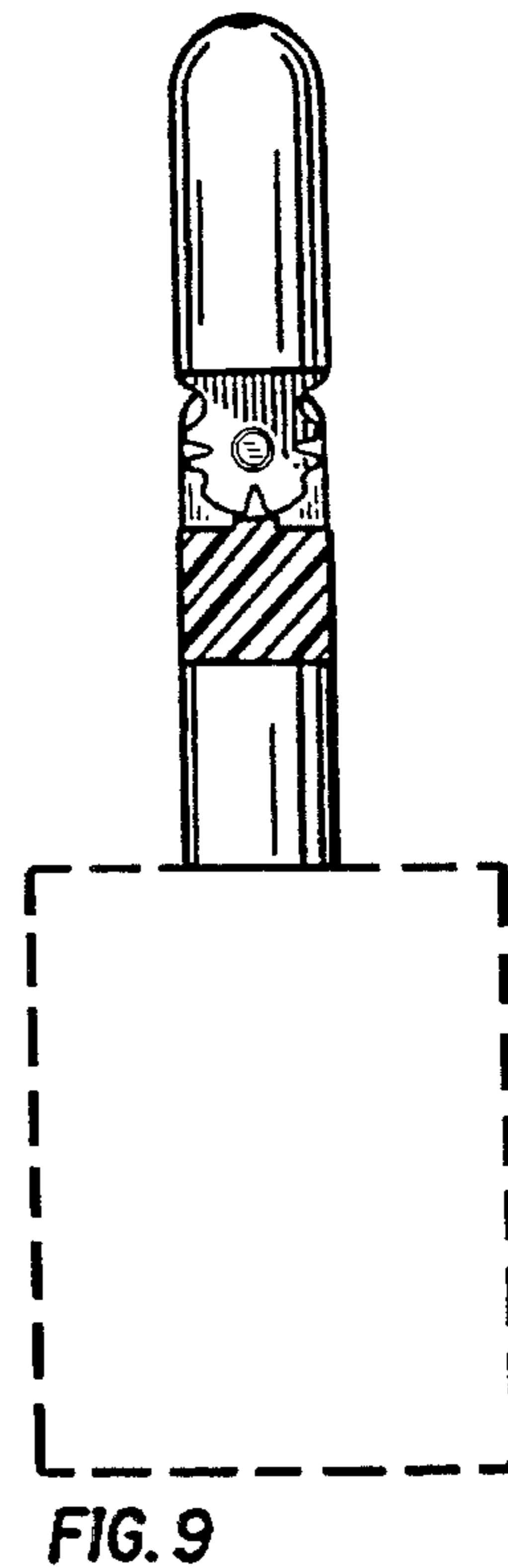

FIG. 9

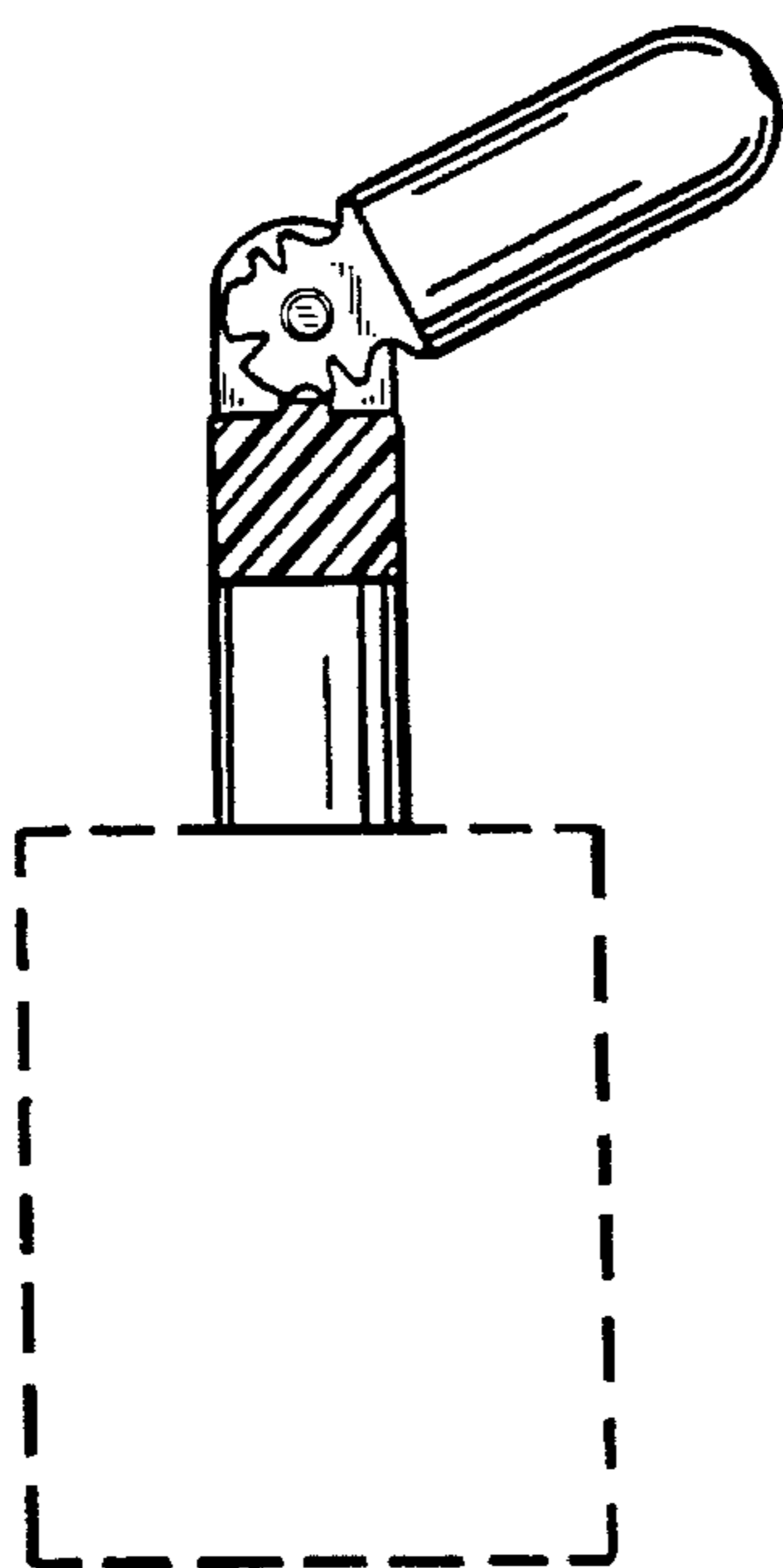

FIG. 10

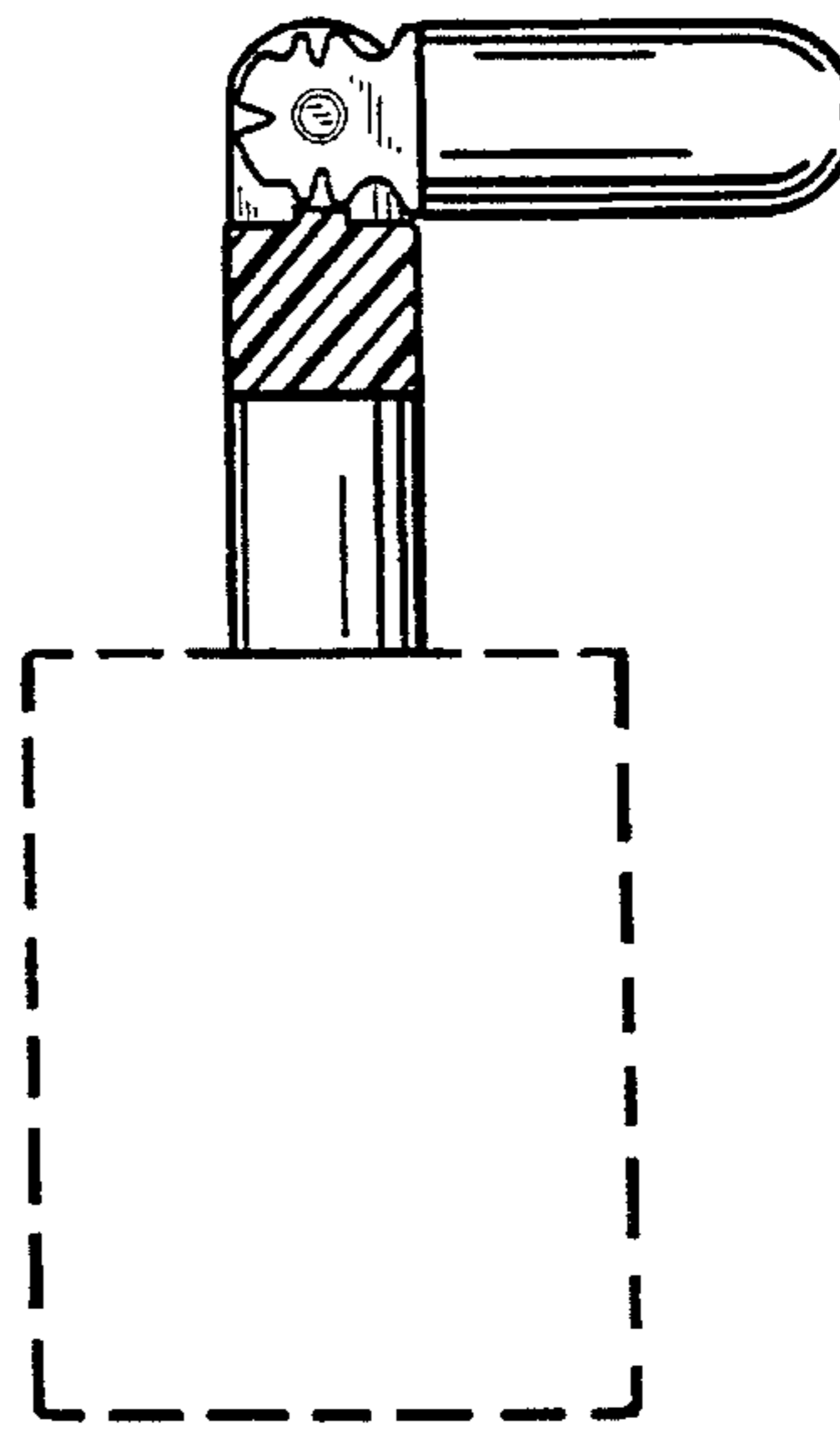

FIG. 11

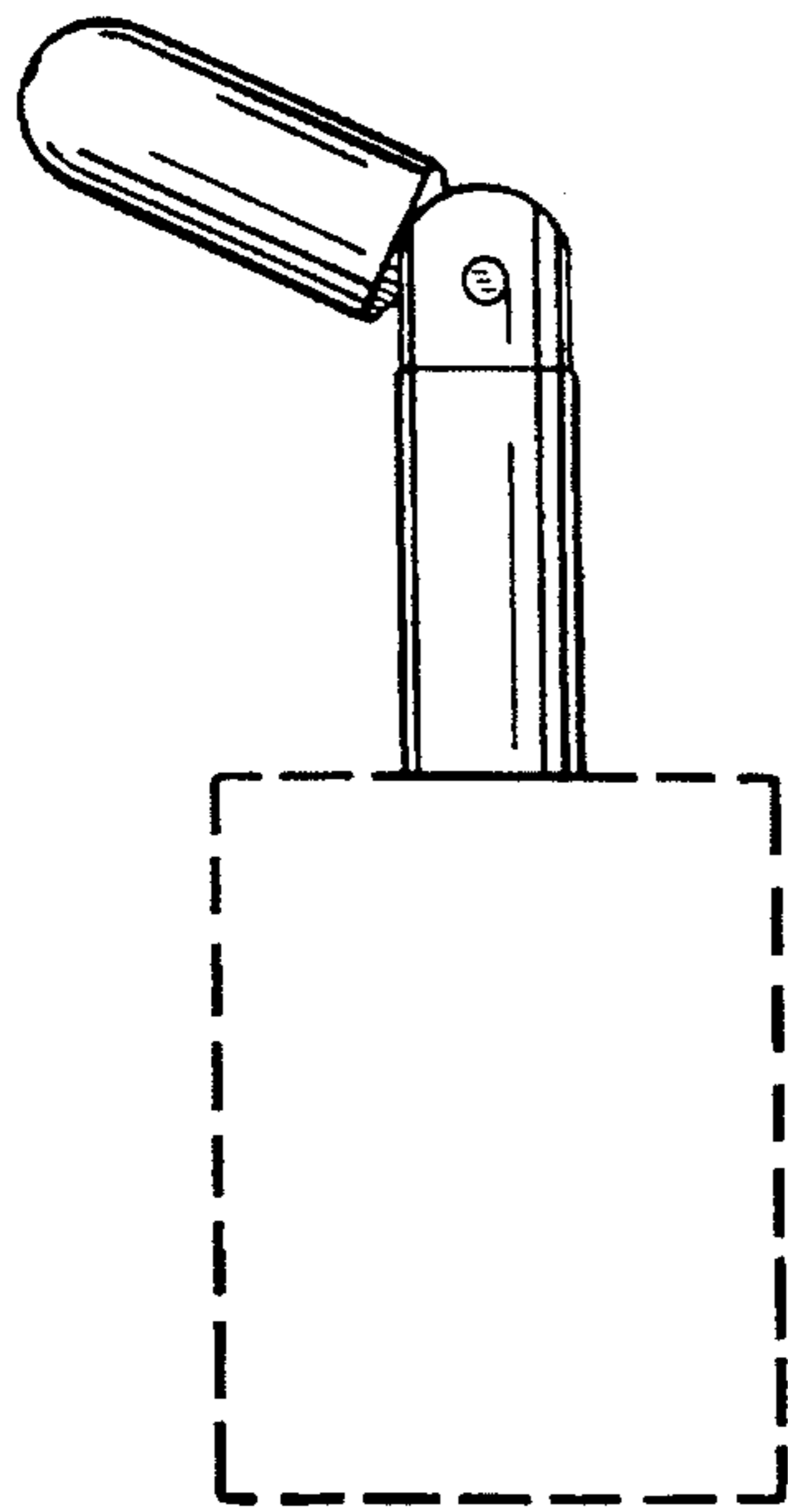

FIG. 12

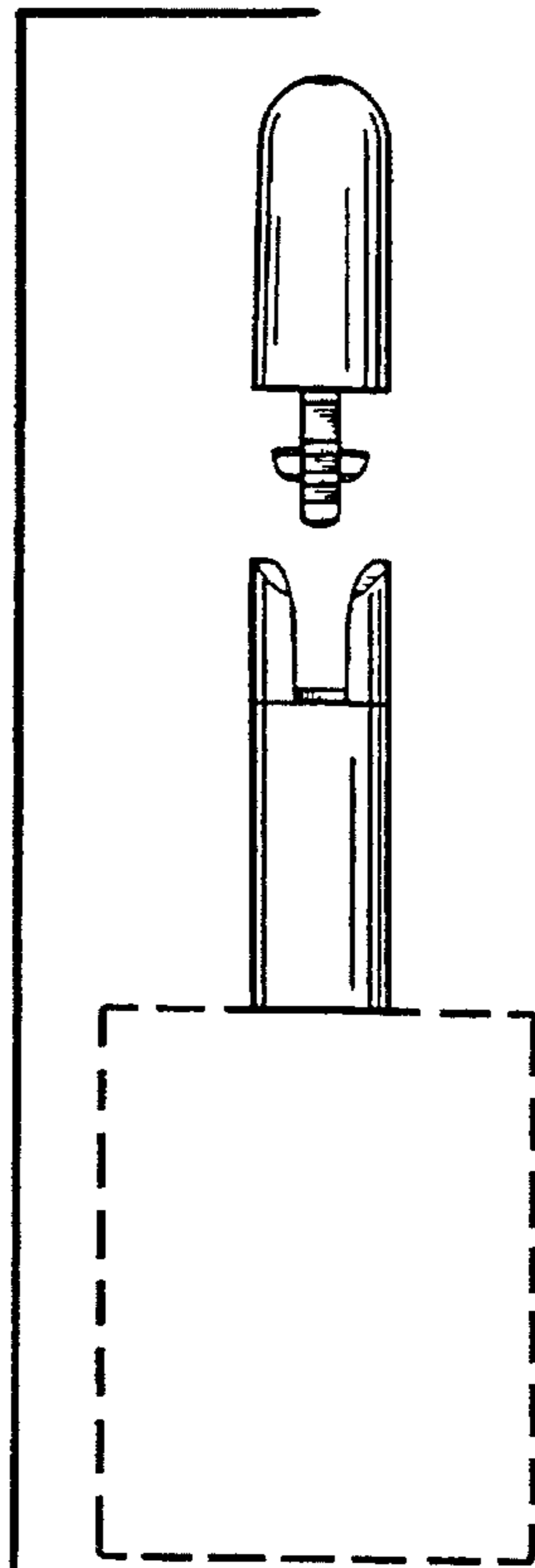

FIG. 14

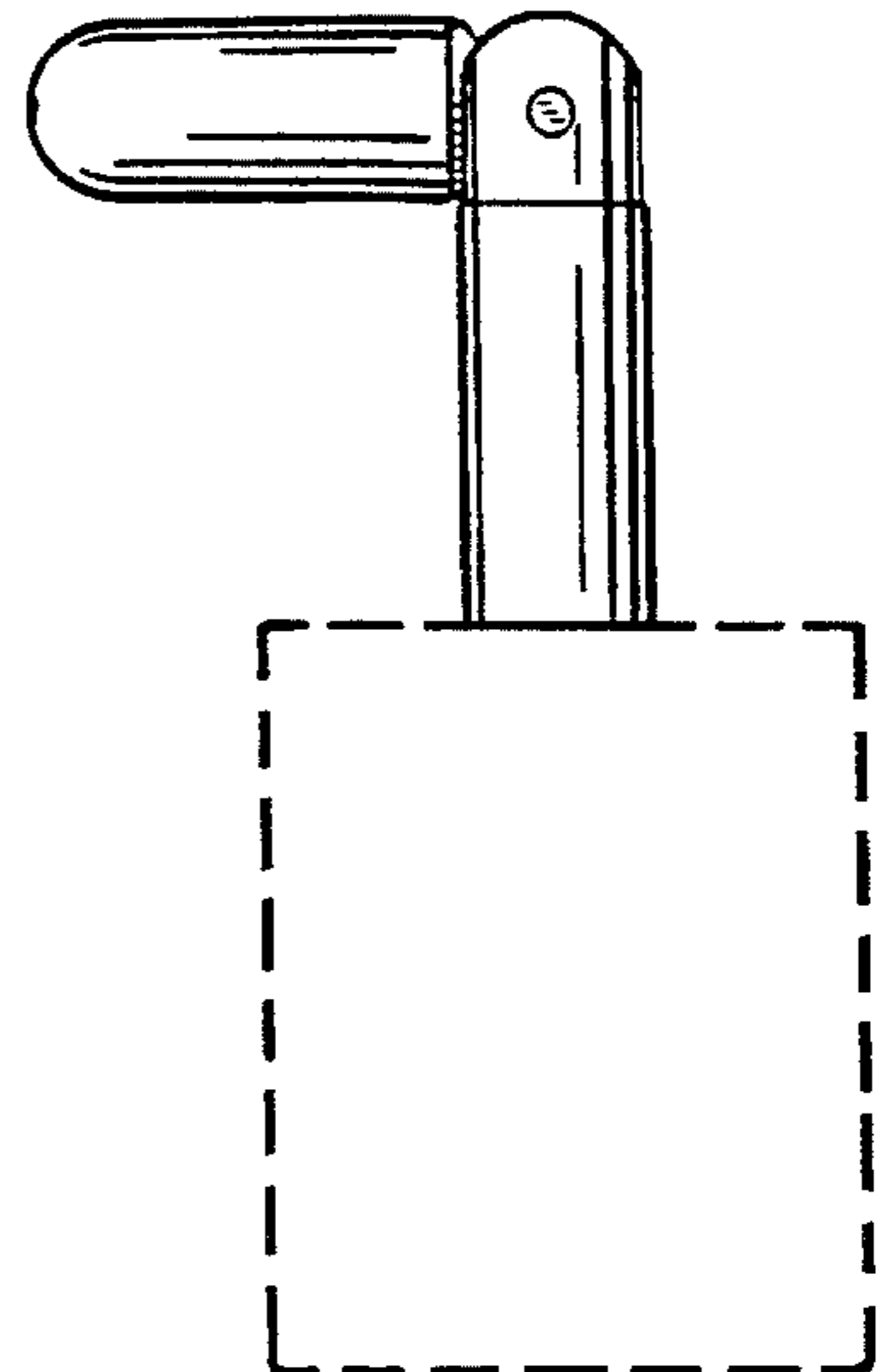

FIG. 13

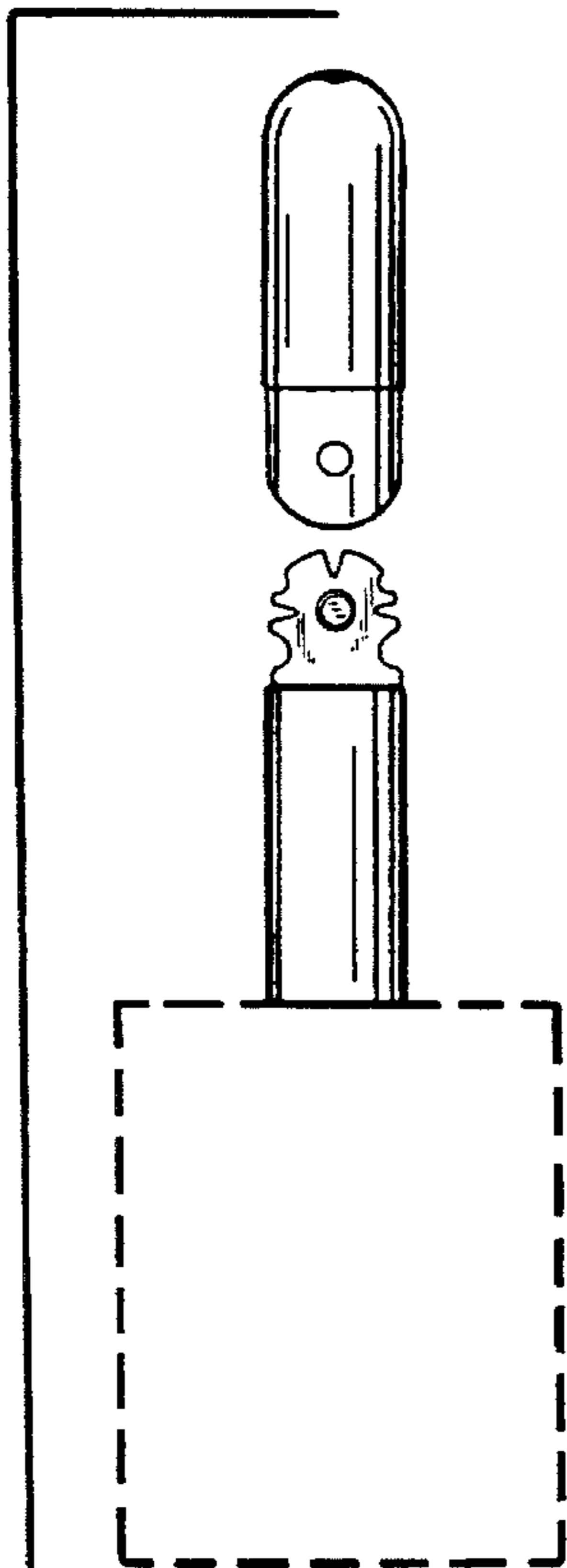

FIG. 15

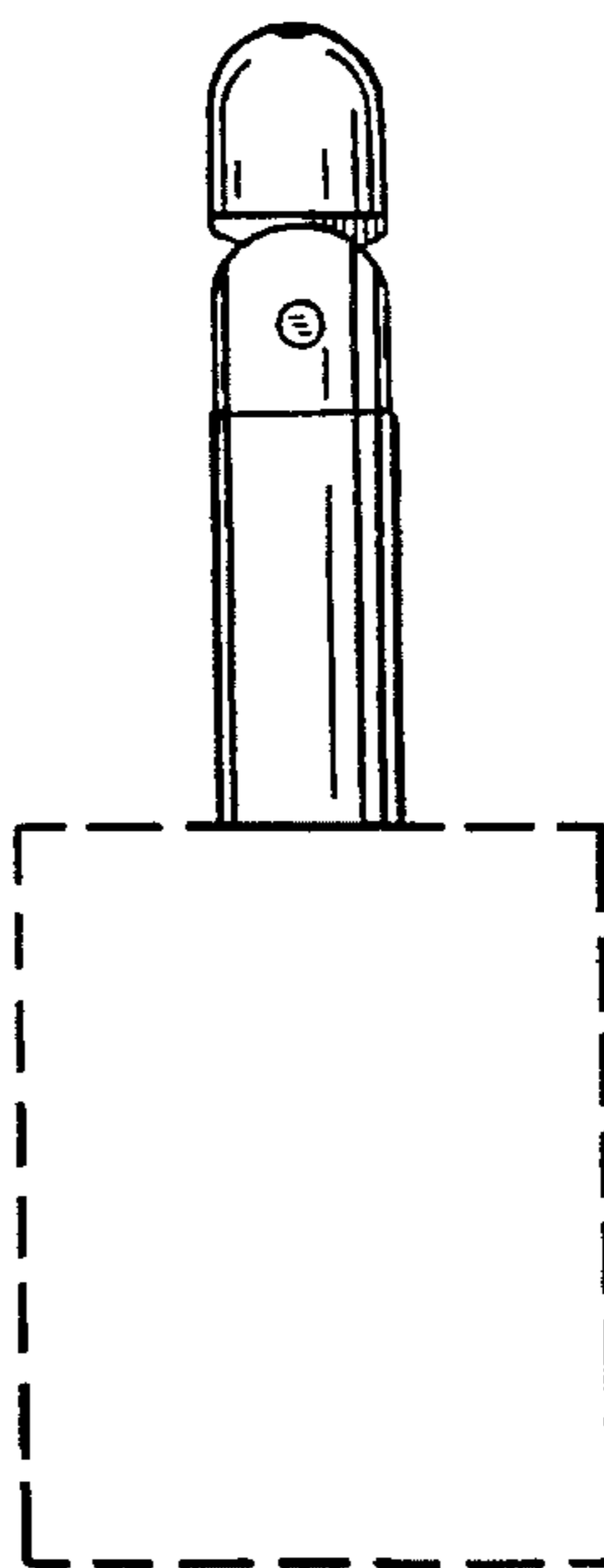

FIG. 17

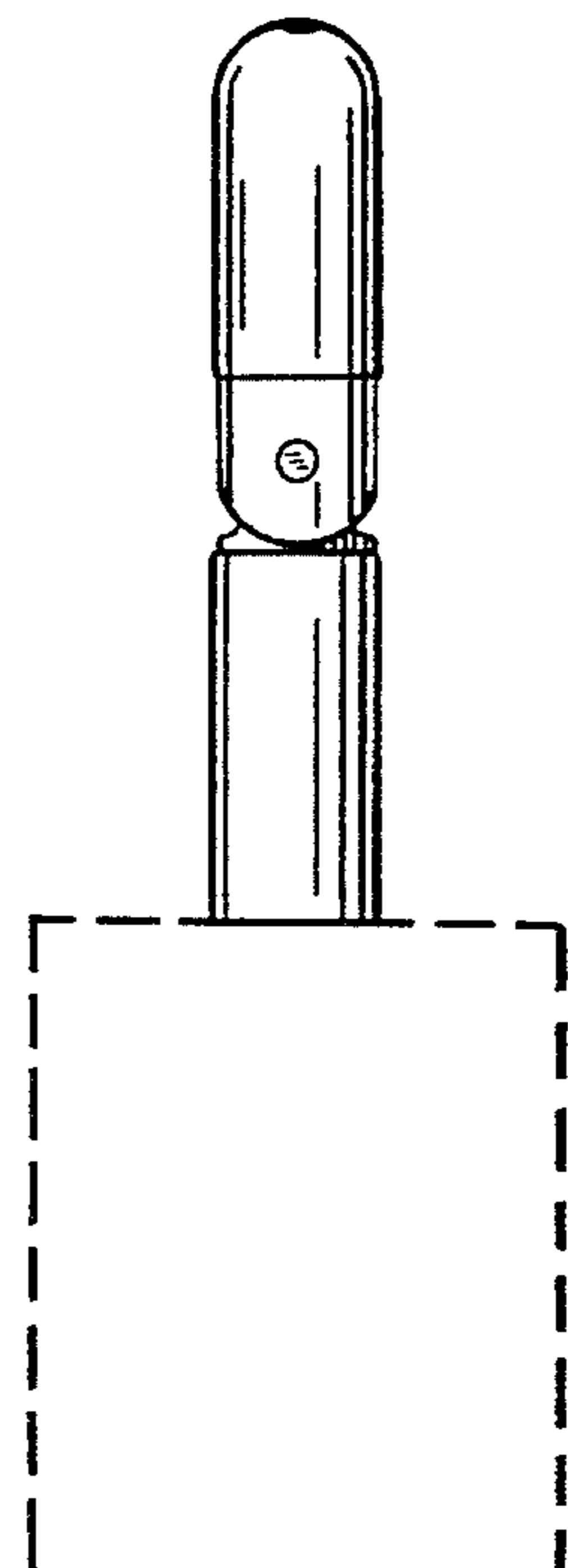

FIG. 16

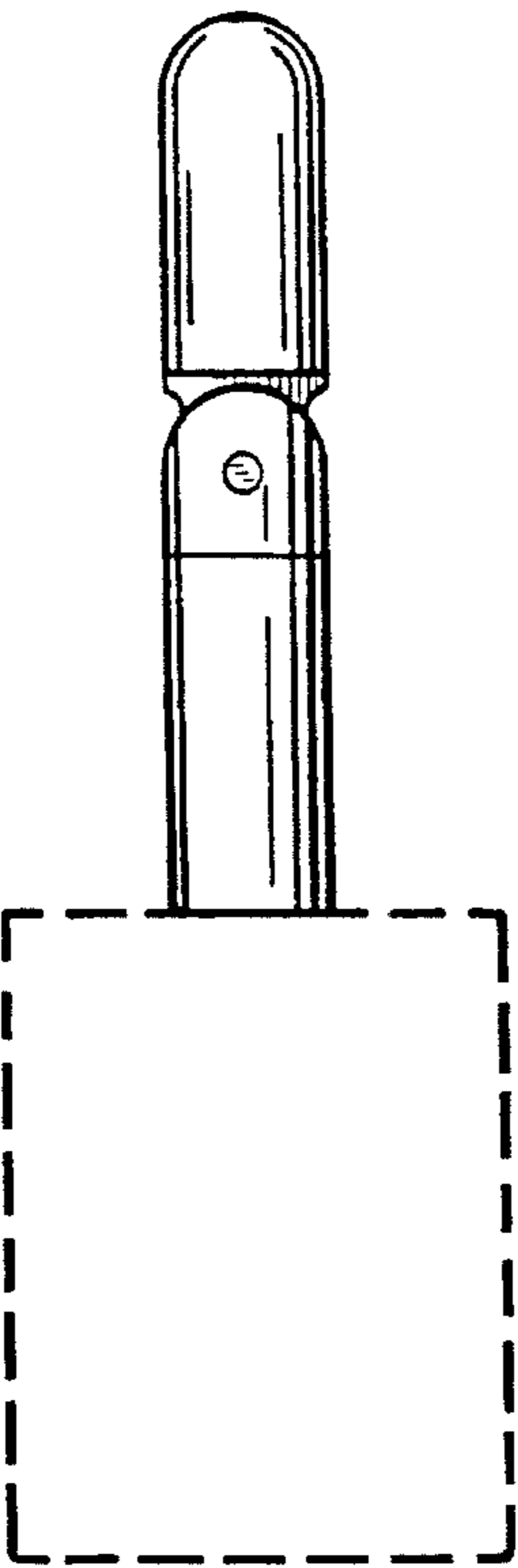

FIG. 18

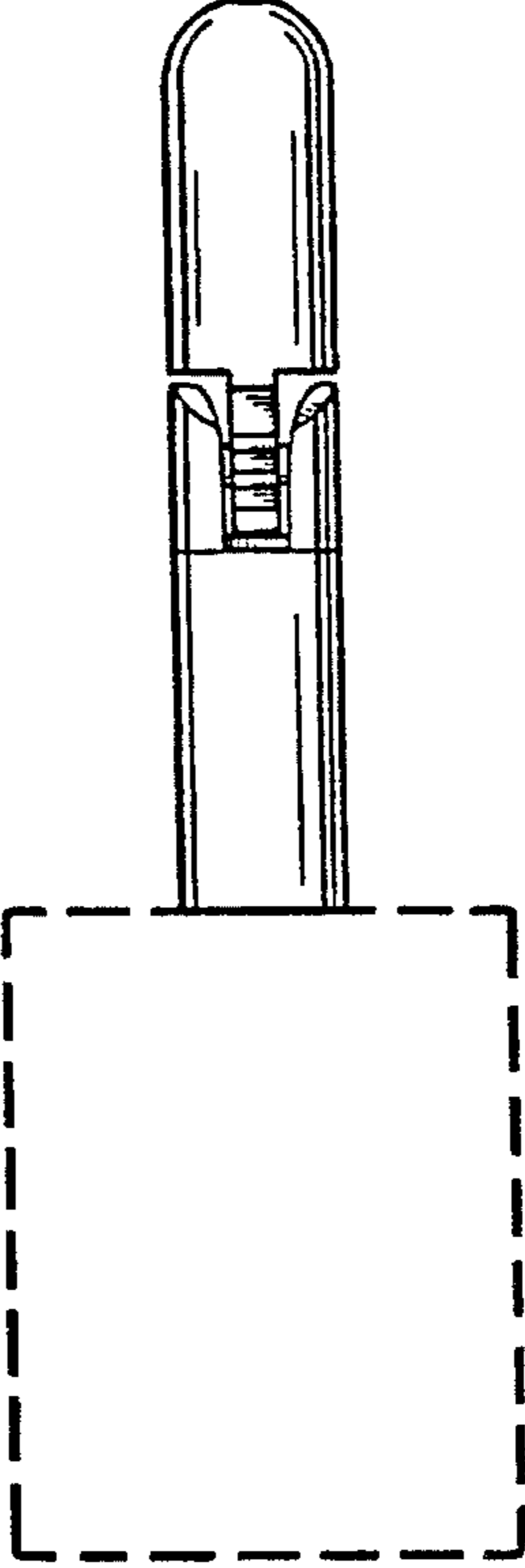

FIG. 19

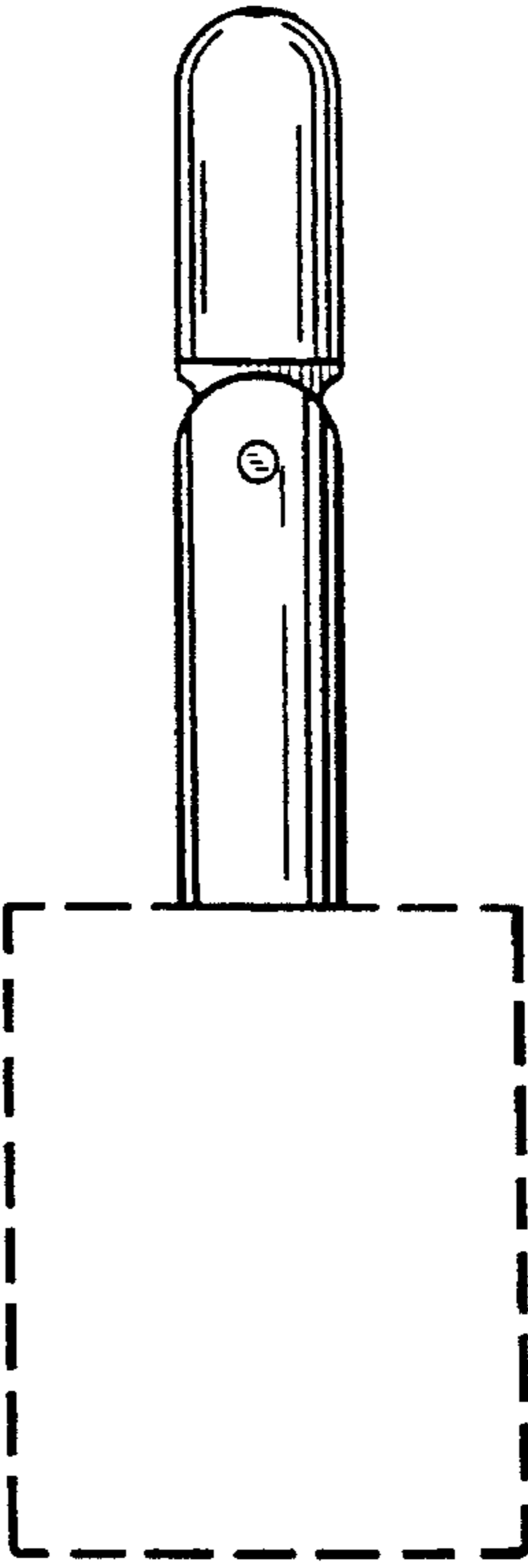

FIG. 20

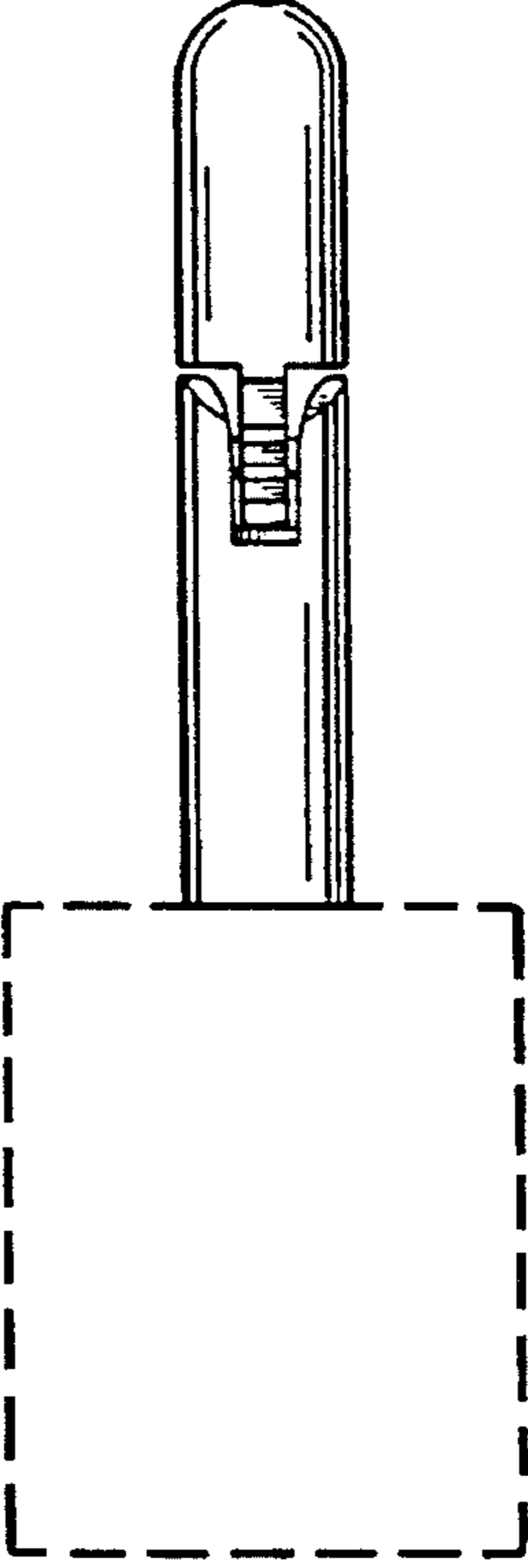

FIG. 21

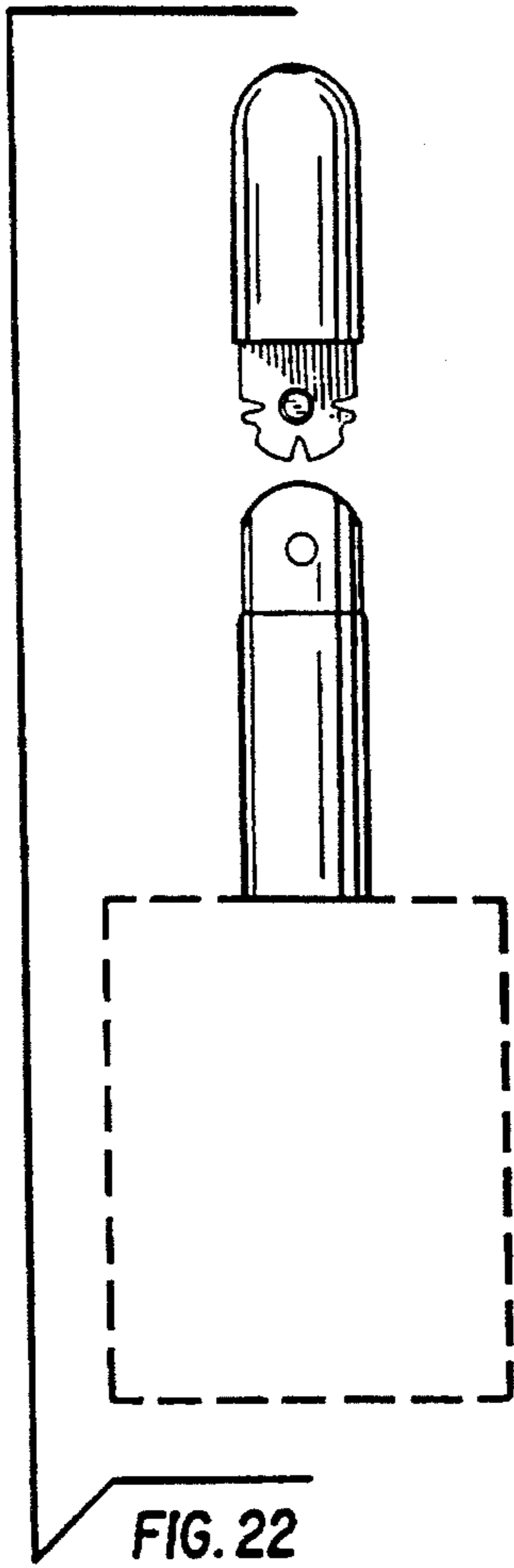

FIG. 22

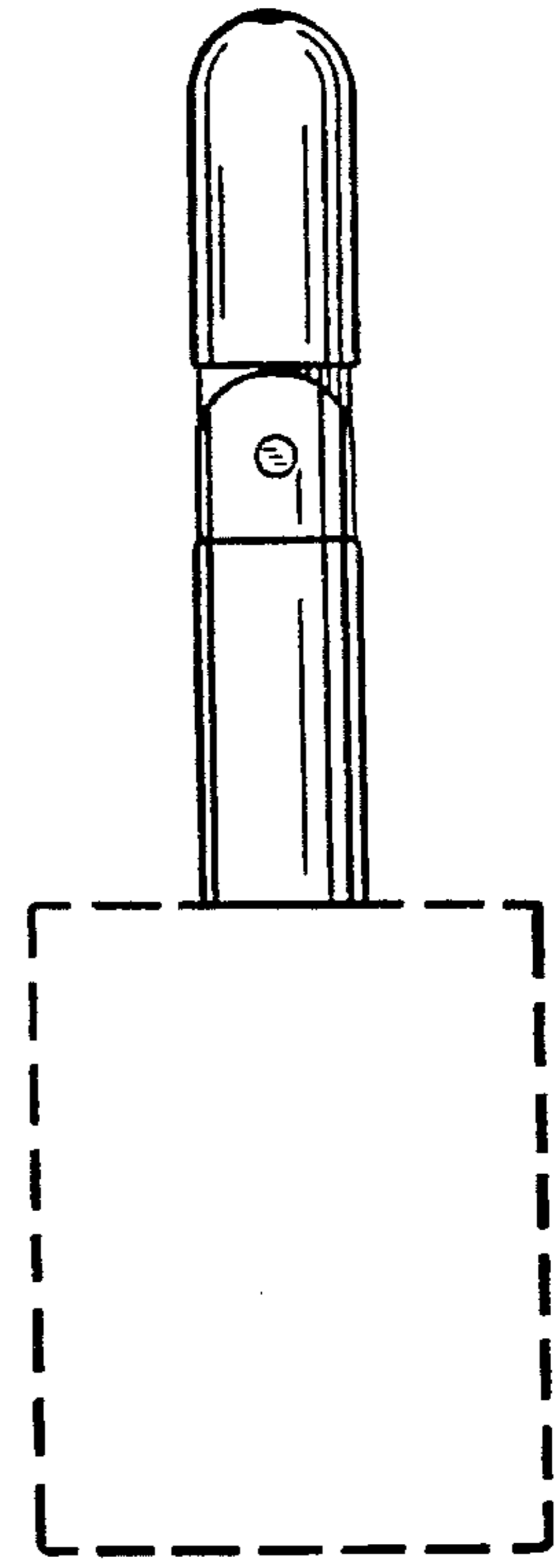

FIG. 23

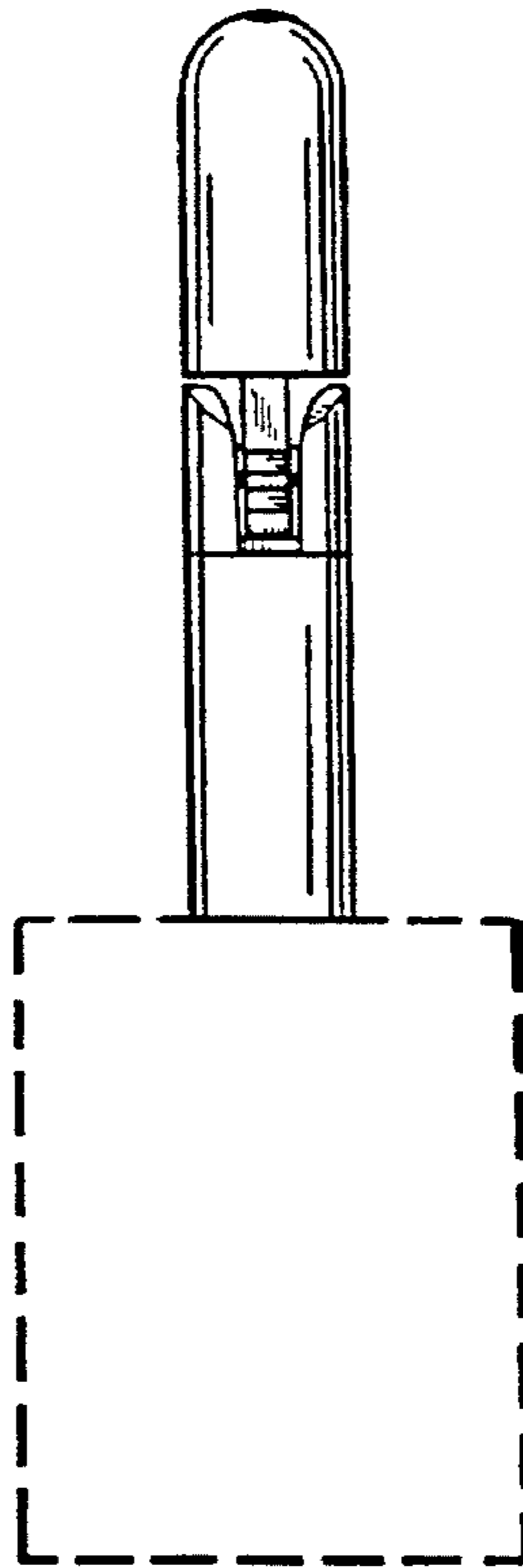

FIG. 24

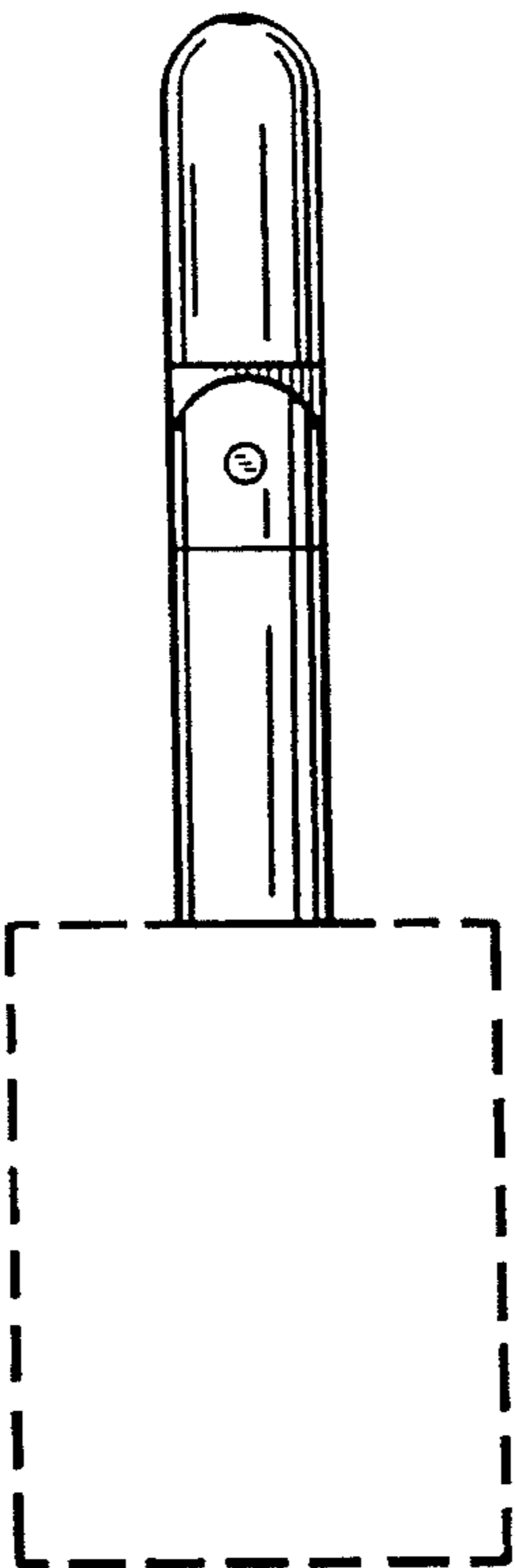

FIG. 25

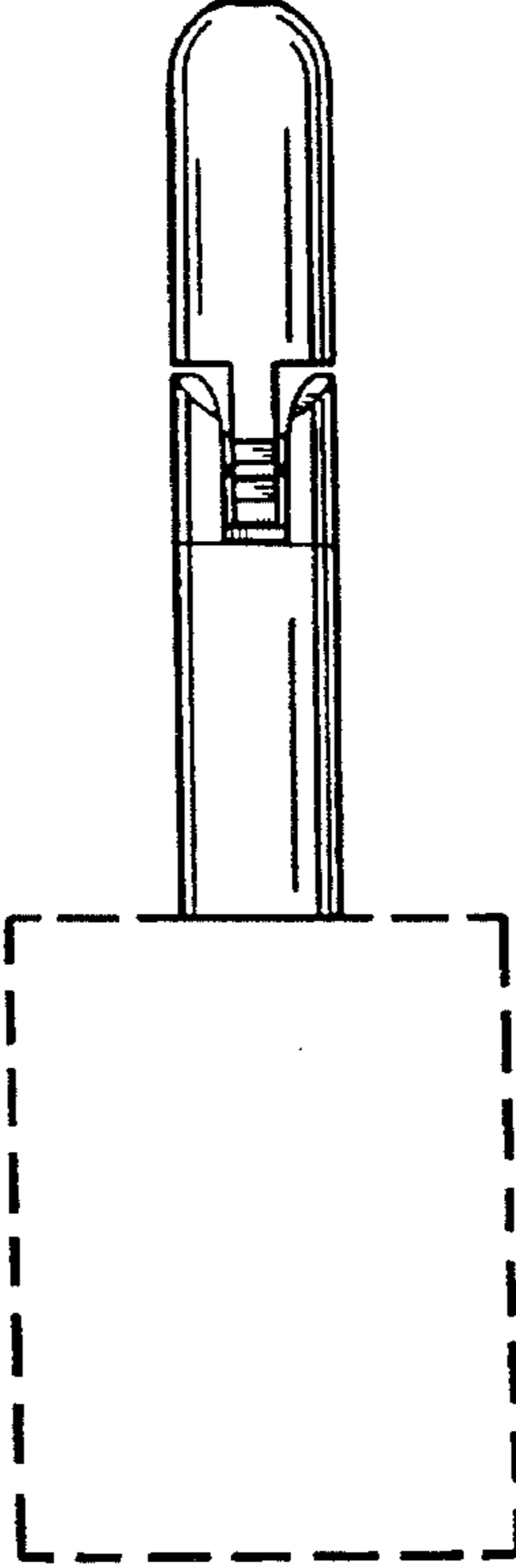

FIG. 26

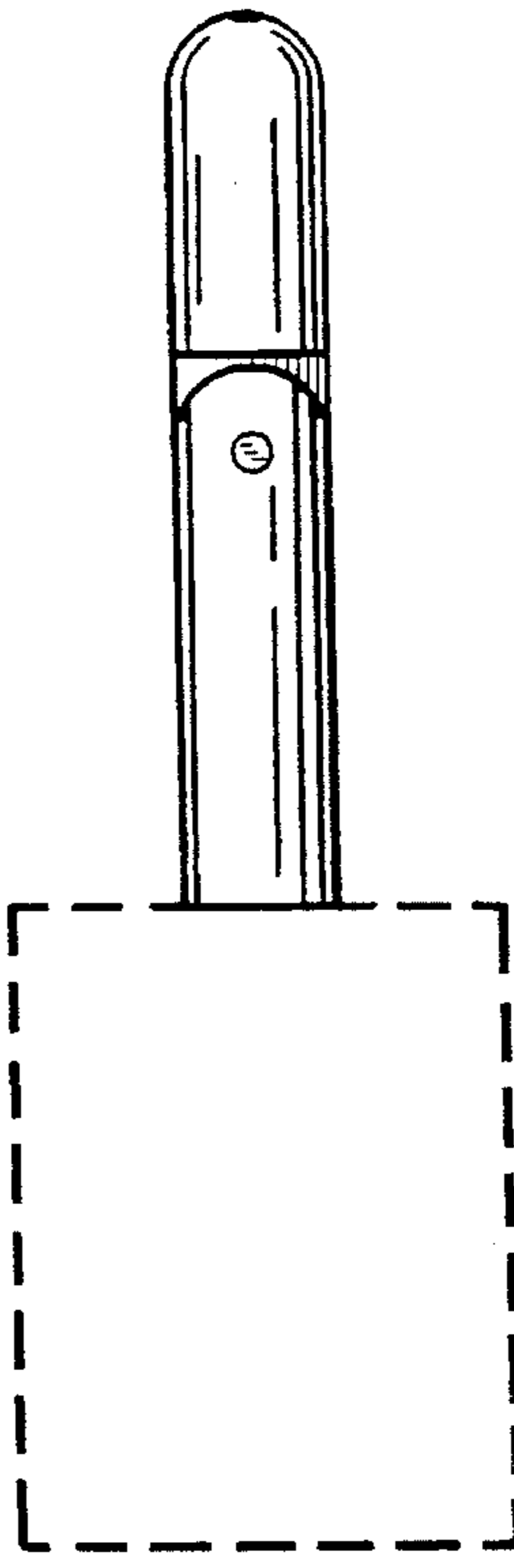

FIG. 27

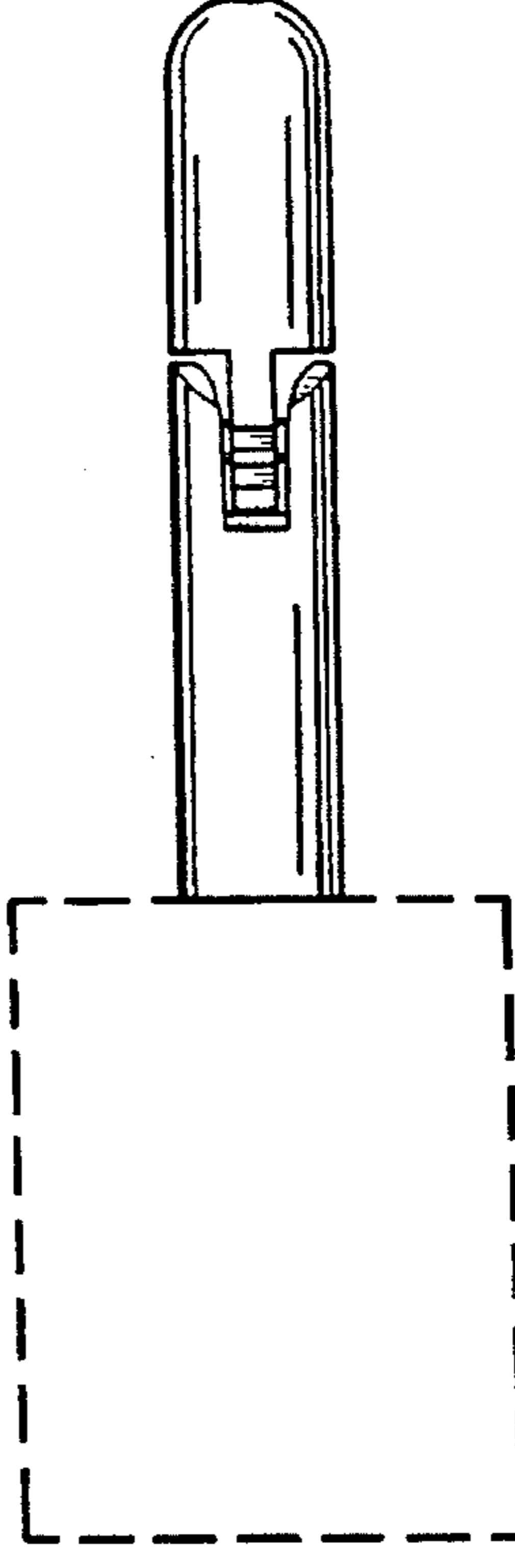

FIG. 28

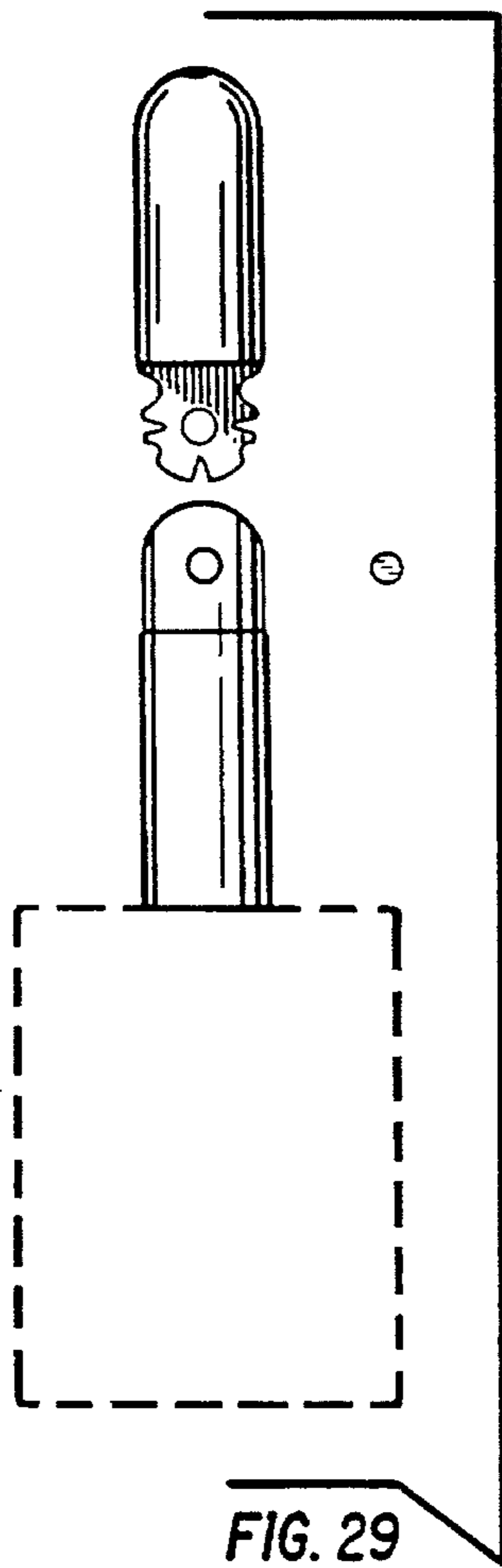

FIG. 29

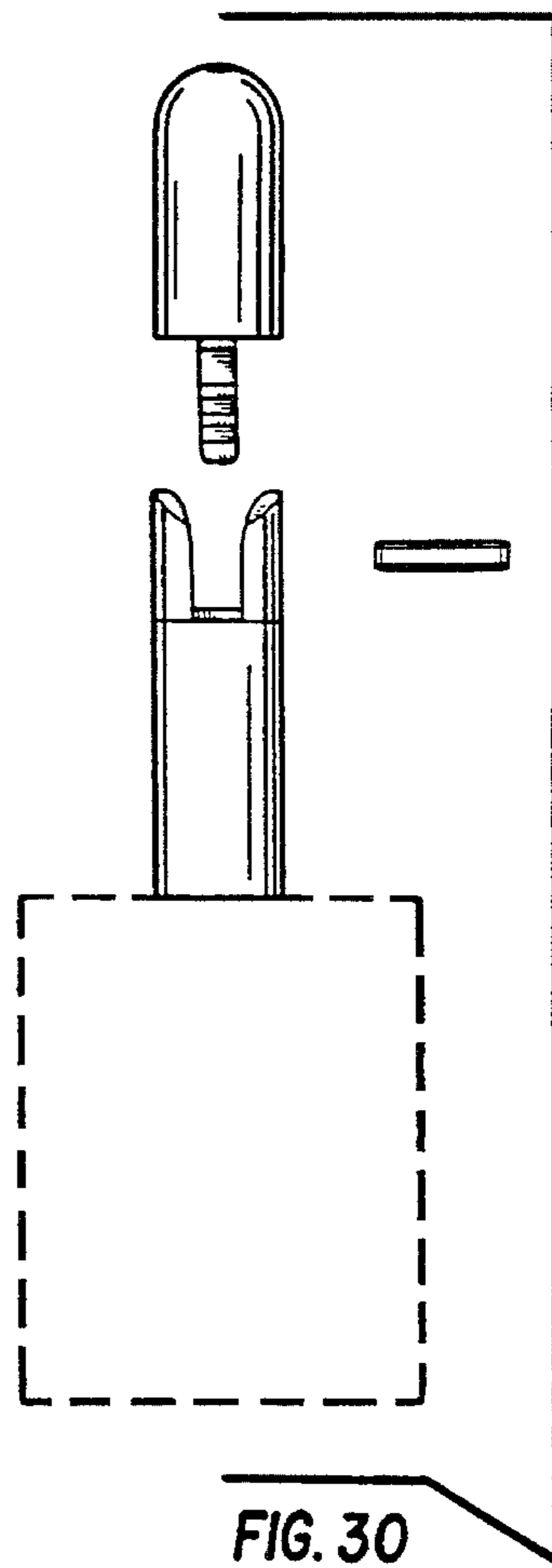

FIG. 30