



US00D370055S

United States Patent [19]
Mathison

[11] **Patent Number: Des. 370,055**

[45] **Date of Patent: **May 21, 1996**

[54] **SMALL DRAIN FLUSHING EXPANDABLE PLUG**

[75] Inventor: **Allen D. Mathison**, Richfield, Minn.

[73] Assignee: **Cherne Industries Incorporated**,
Minneapolis, Minn.

[**] Term: **14 Years**

[21] Appl. No.: **34,018**

[22] Filed: **Jan. 25, 1995**

[52] U.S. Cl. **D23/260**

[58] **Field of Search** D23/259, 260;
220/352, DIG. 19; 138/89, 97, 98, 93, 109;
4/286-288, 290, 292, 295, 256.1

[56] **References Cited**

U.S. PATENT DOCUMENTS

339,405	9/1993	Bevacco et al.	D23/213
3,086,540	4/1963	Anderson	138/93 X
3,173,449	3/1965	Custer et al.	138/93

Primary Examiner—Louis S. Zarfes
Assistant Examiner—E. Watterson
Attorney, Agent, or Firm—Anthony G. Eggink

[57] **CLAIM**

The ornamental design for a small drain flushing expandable plug, as shown and described.

DESCRIPTION

FIG. 1 is a perspective view of a small drain flushing expandable plug, showing my new design; the sectioned hose showing indeterminate length thereof; FIG. 2 is a side view thereof; the opposite side view, top and bottom views being mirror images thereof; FIG. 3 is an end view thereof; FIG. 4 is an end view opposite the end view of FIG. 3; FIG. 5 is a side view showing the flexibility of the hose of the small drain flushing expandable plug; and, FIG. 6 is a side view showing the small drain flushing expandable plug expanded in a pipe; the dotted lines showing the faucet, the pipe and fluid spray are environmental only and do not form a part of the invention.

1 Claim, 5 Drawing Sheets

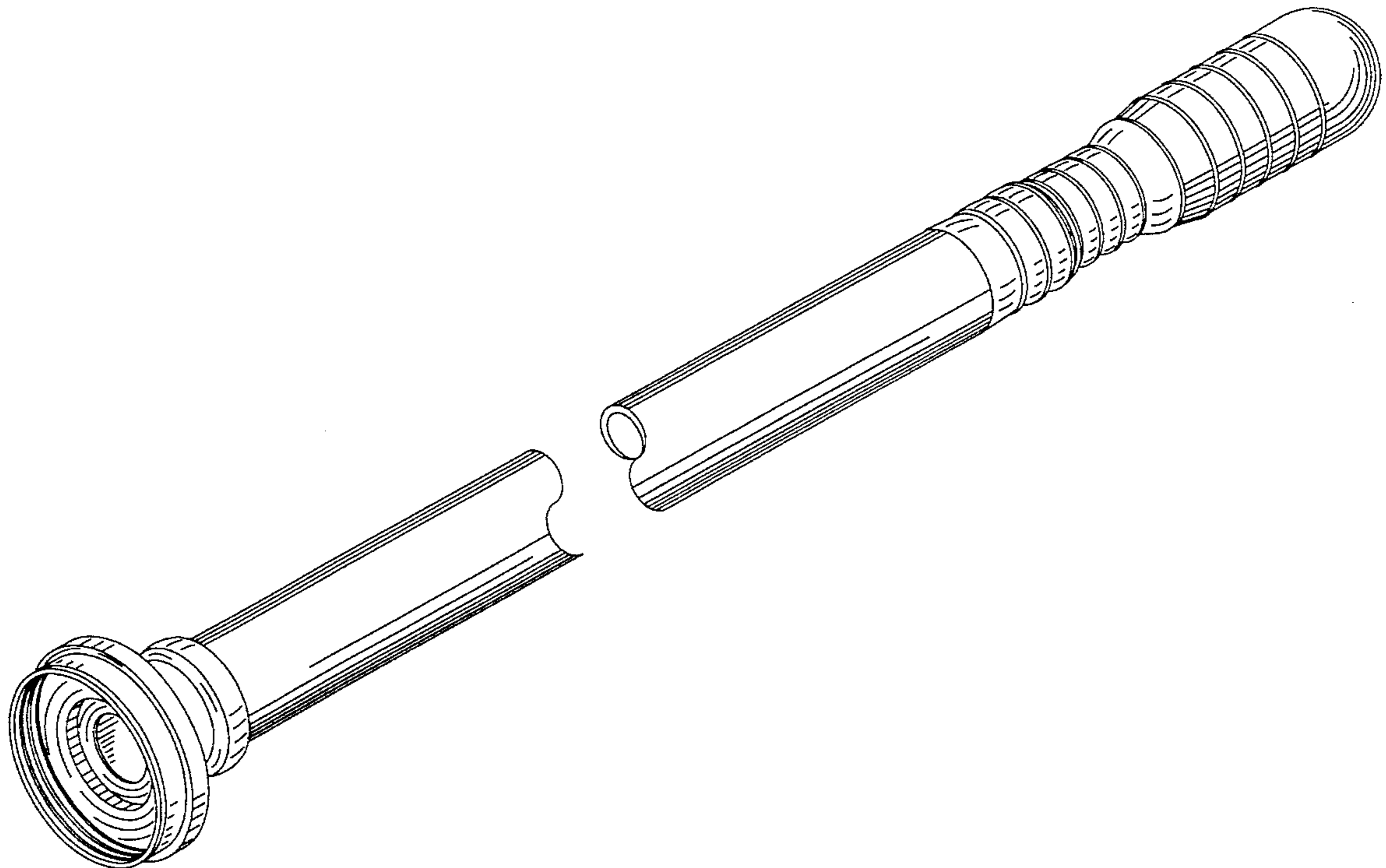

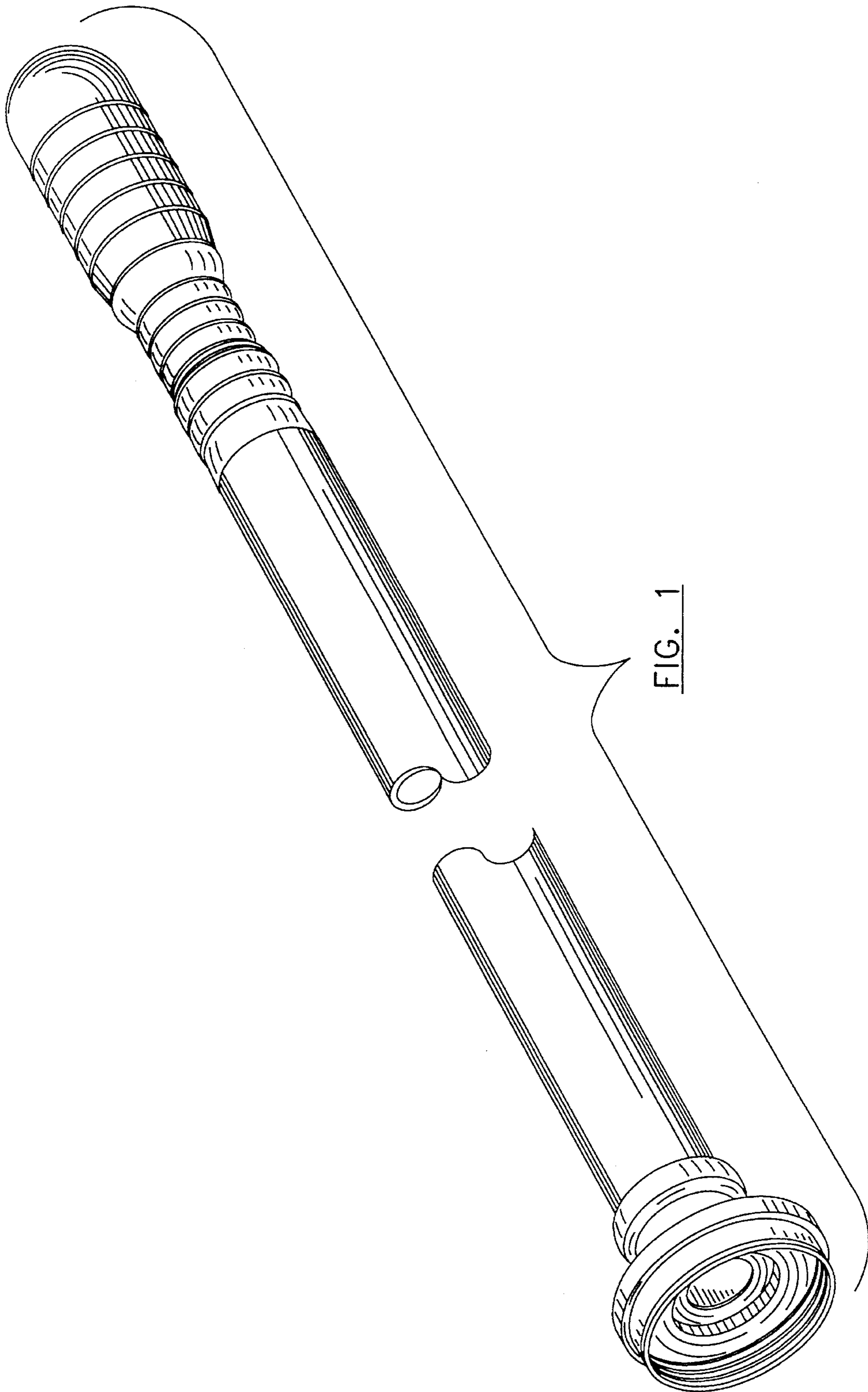

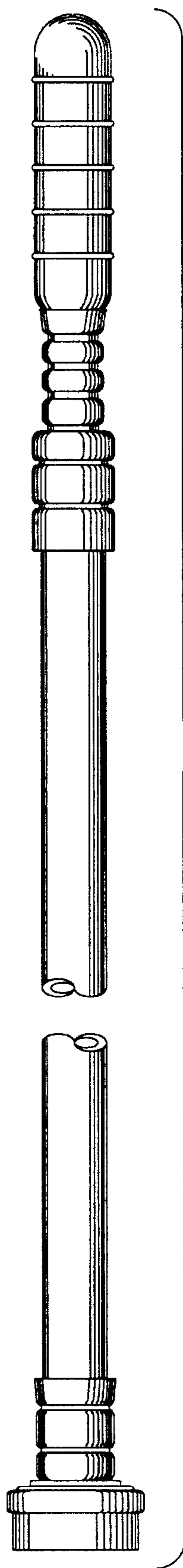

FIG. 2

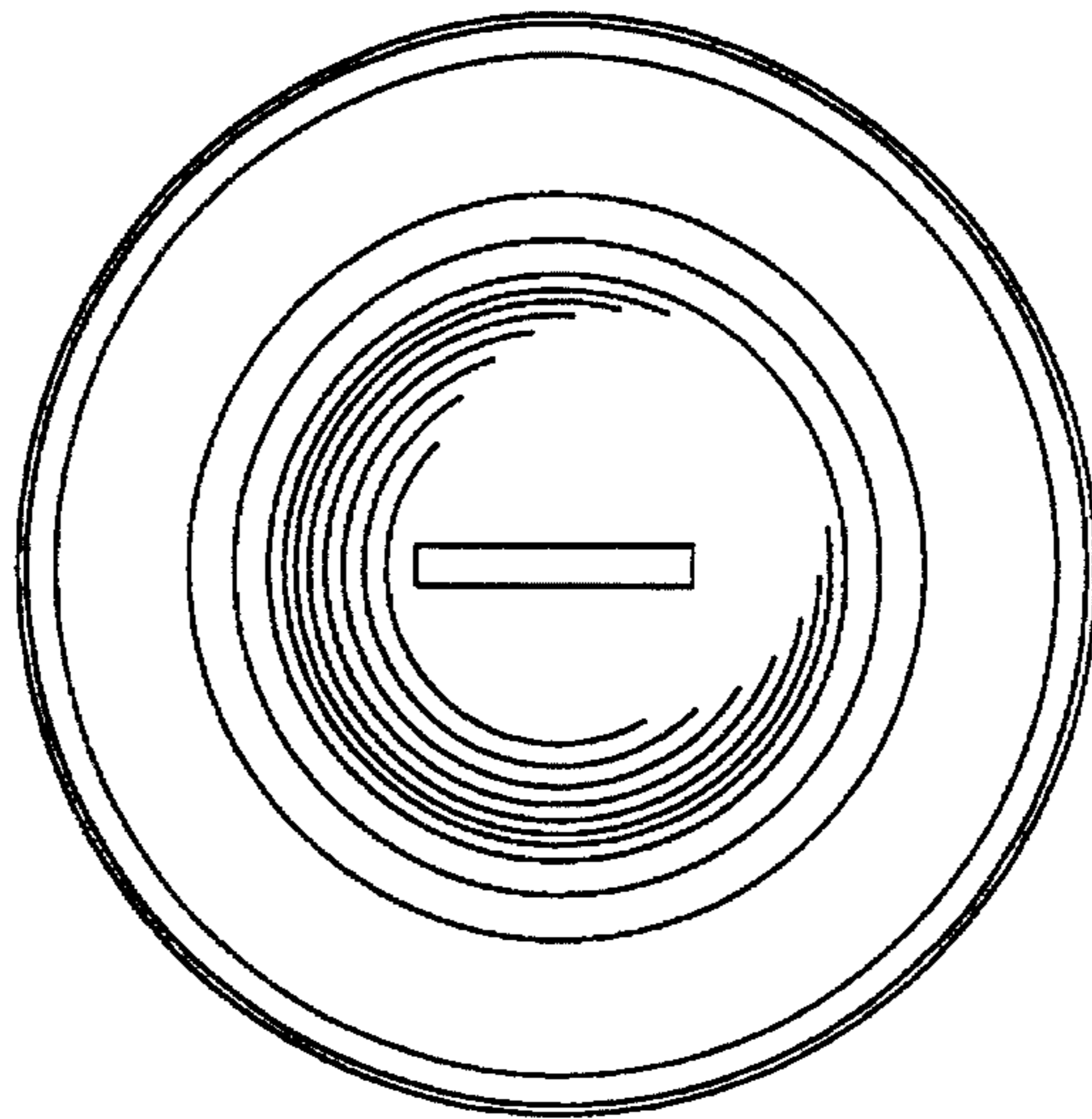

FIG. 3

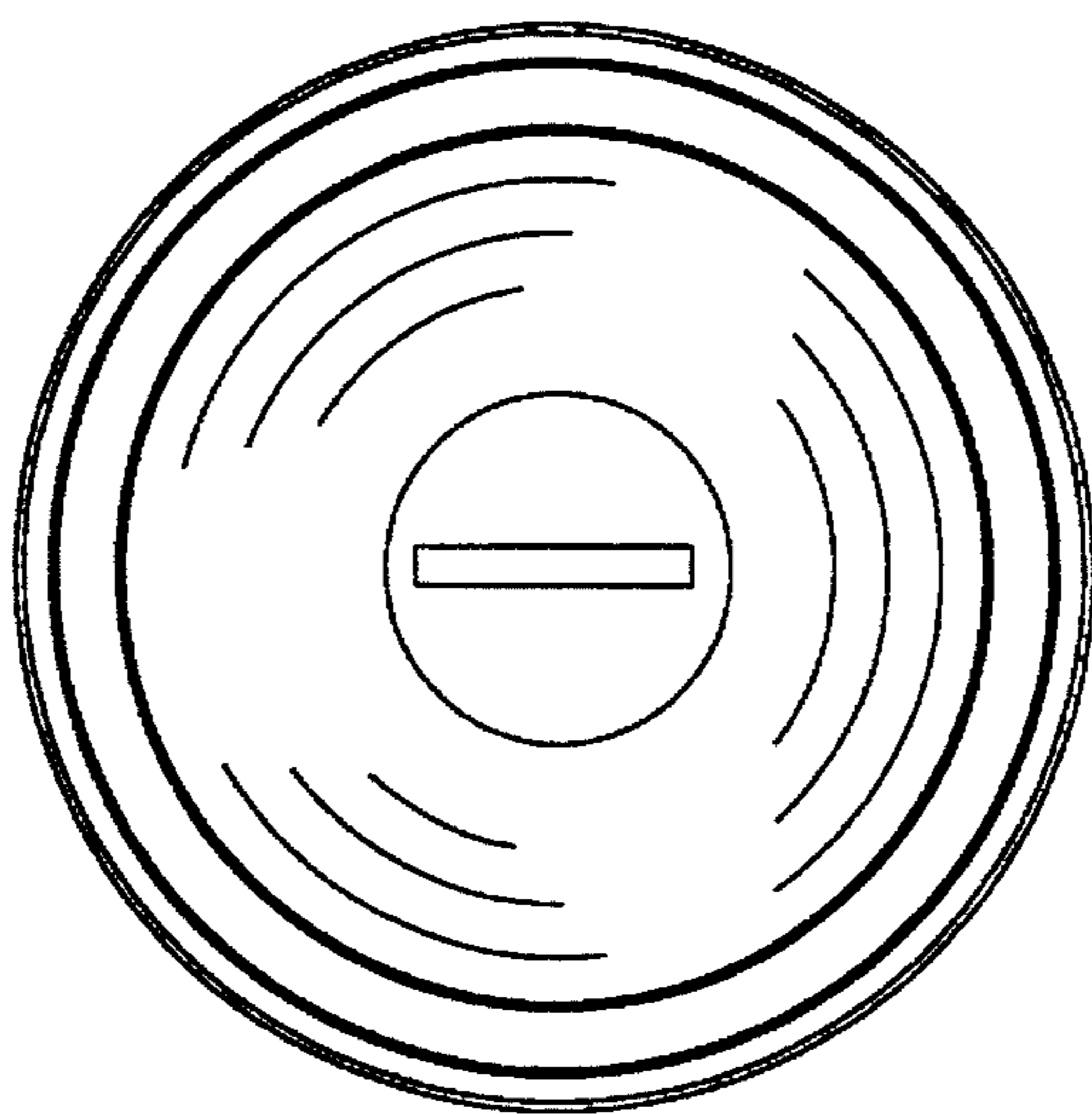

FIG. 4

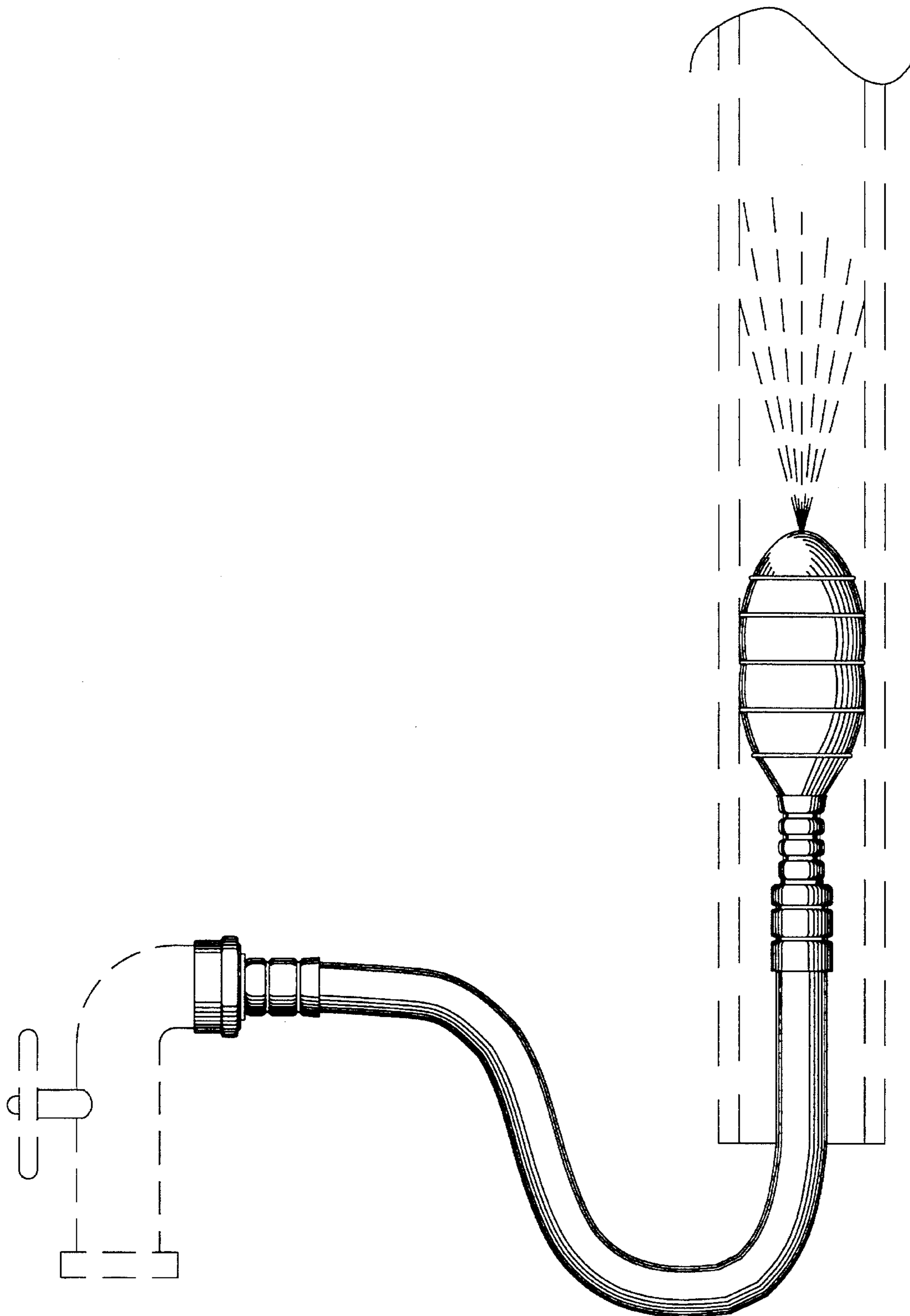

FIG. 5

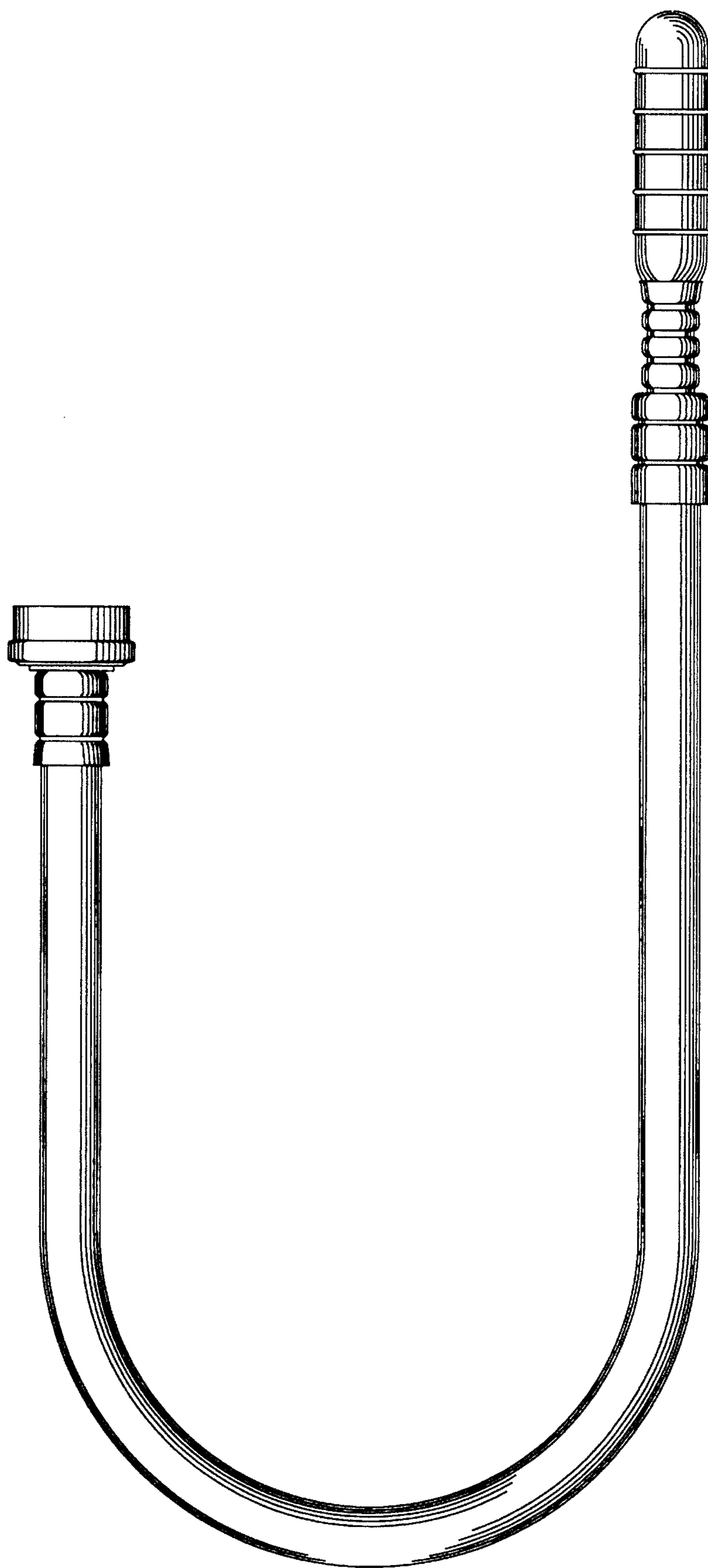

FIG. 6