



US00D369993S

United States Patent [19] Gonzales

[11] **Patent Number: Des. 369,993**

[45] **Date of Patent: **May 21, 1996**

[54] **STROLLER**

4,089,543 5/1978 Osborne 280/650

[76] Inventor: **Richard L. Gonzales**, 2725 Chinook Ct., Union City, Calif. 94587

Primary Examiner—Kay H. Chin

[**] Term: **14 Years**

[57] **CLAIM**

The ornamental design for a stroller, as shown and described.

[21] Appl. No.: **37,240**

[22] Filed: **Apr. 7, 1995**

[52] U.S. Cl. **D12/129; D21/78**

[58] Field of Search D12/128, 129; 280/650; D21/78, 76

DESCRIPTION

FIG. 1 is a front elevational view of the stroller showing my new design;

FIG. 2 is a rear elevational view thereof;

FIG. 3 is a left side elevational view thereof;

FIG. 4 is a right side elevational view thereof;

FIG. 5 is a top plan view thereof; and

FIG. 6 is a bottom plan view thereof; and,

FIG. 7 is a top perspective view thereof.

[56] **References Cited**

U.S. PATENT DOCUMENTS

D. 150,256	7/1948	Reinhold	D12/128
D. 158,037	4/1950	Aries	D12/128
D. 160,075	9/1950	Coraccio et al.	D12/128

1 Claim, 4 Drawing Sheets

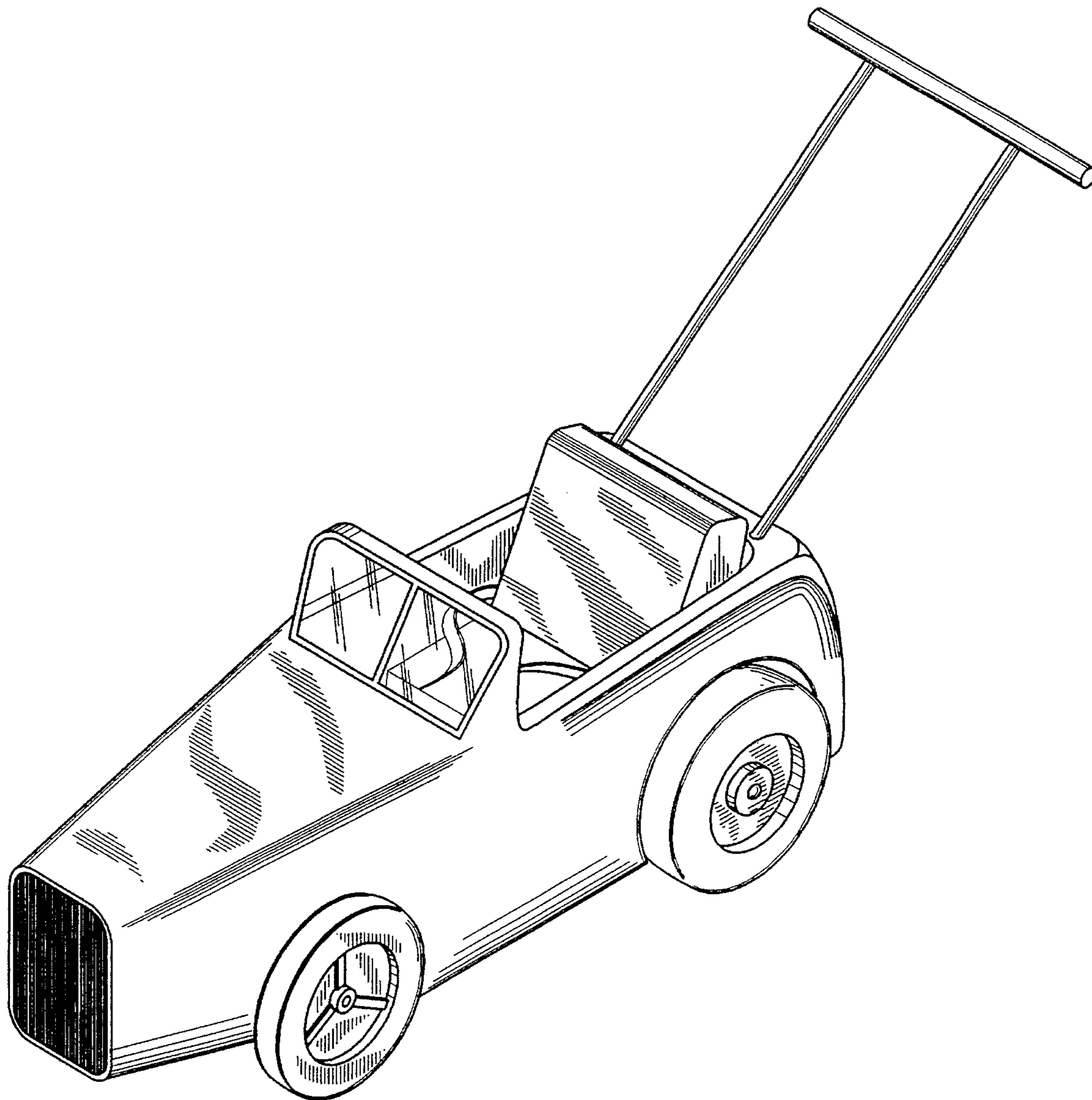

FIG. 1

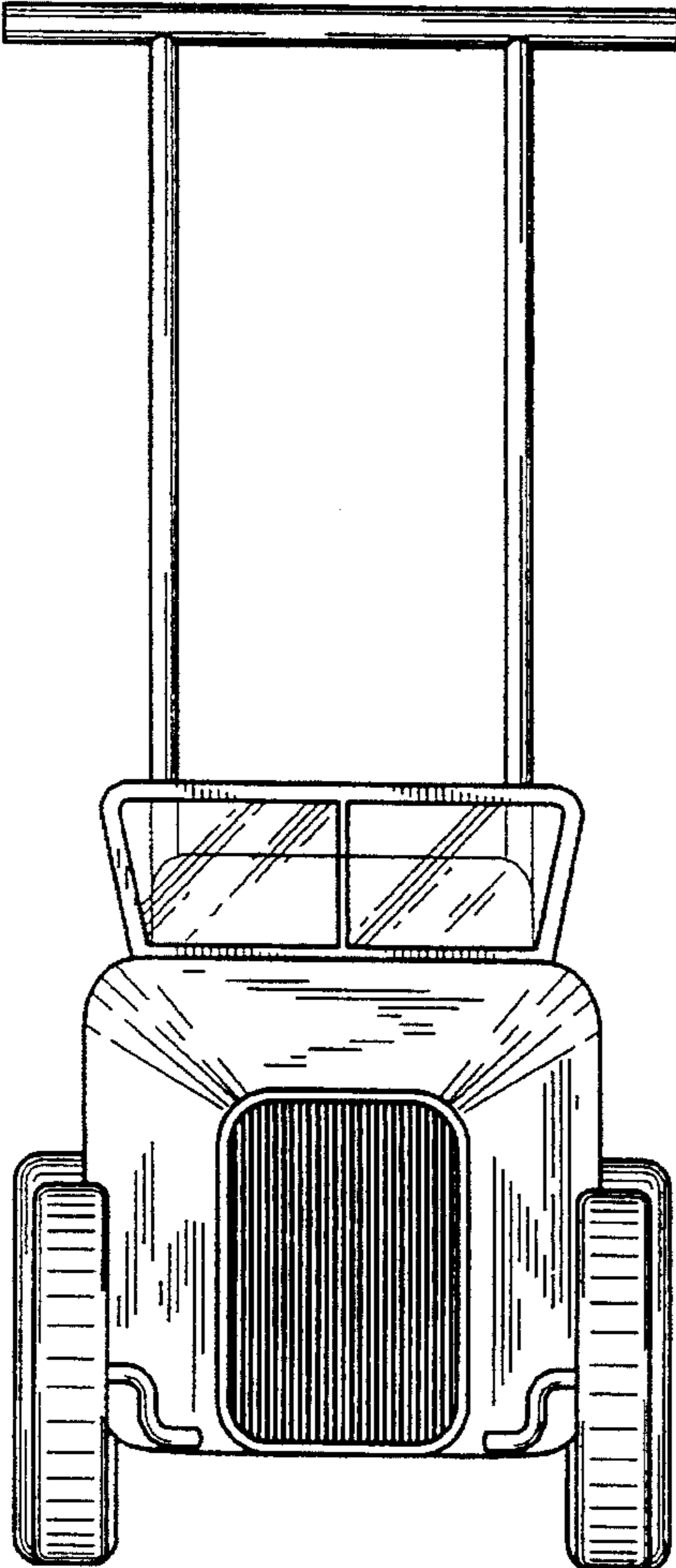

FIG. 2

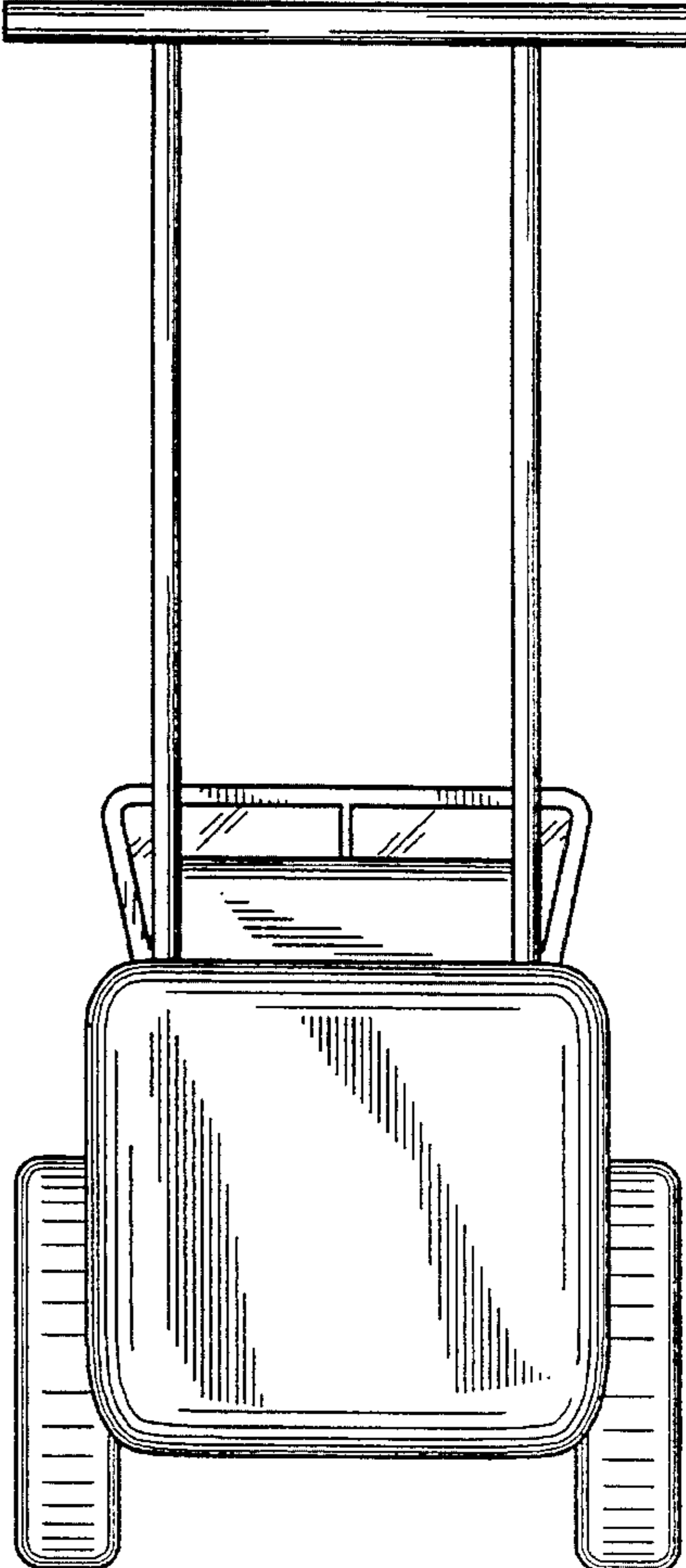

FIG. 3

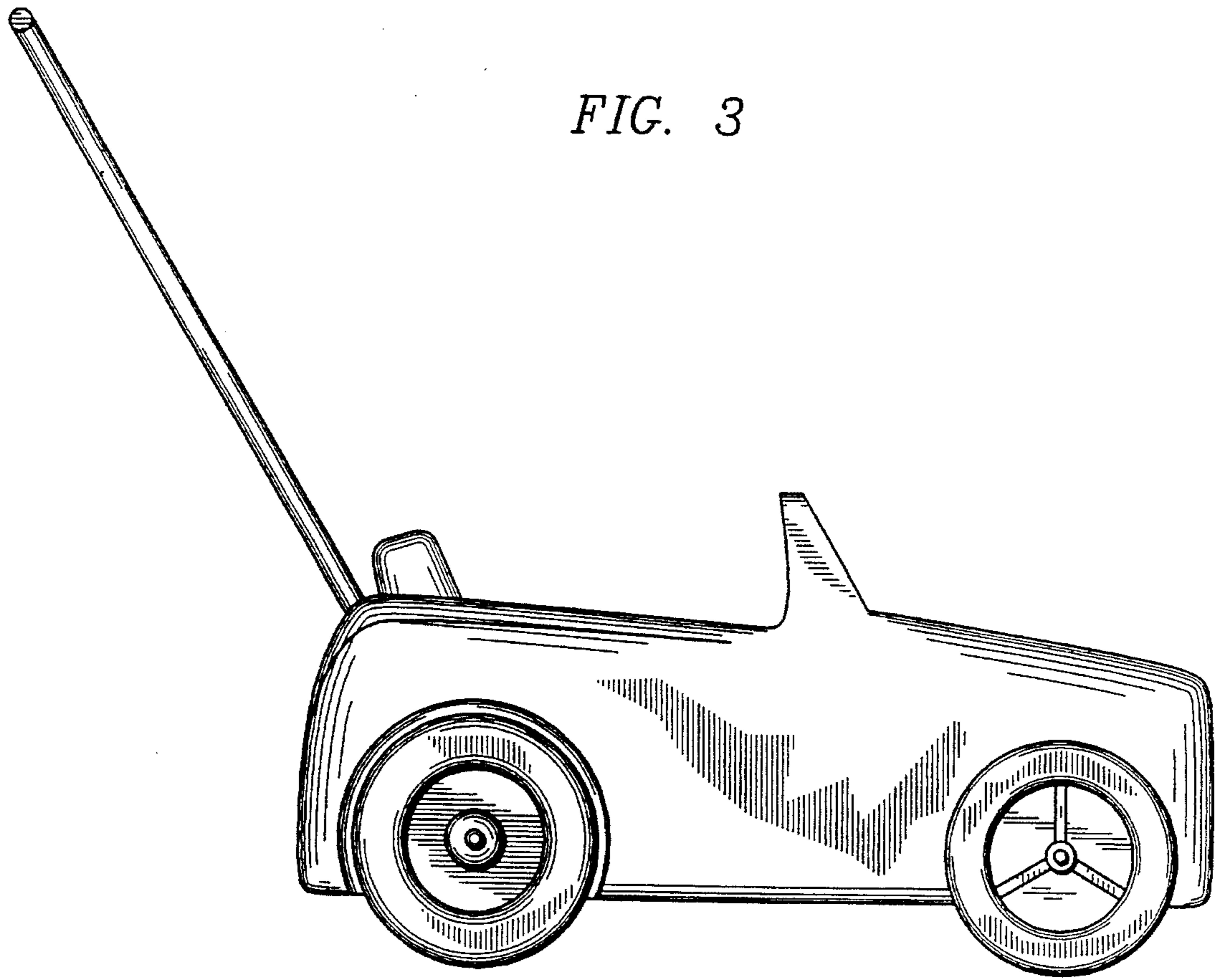

FIG. 4

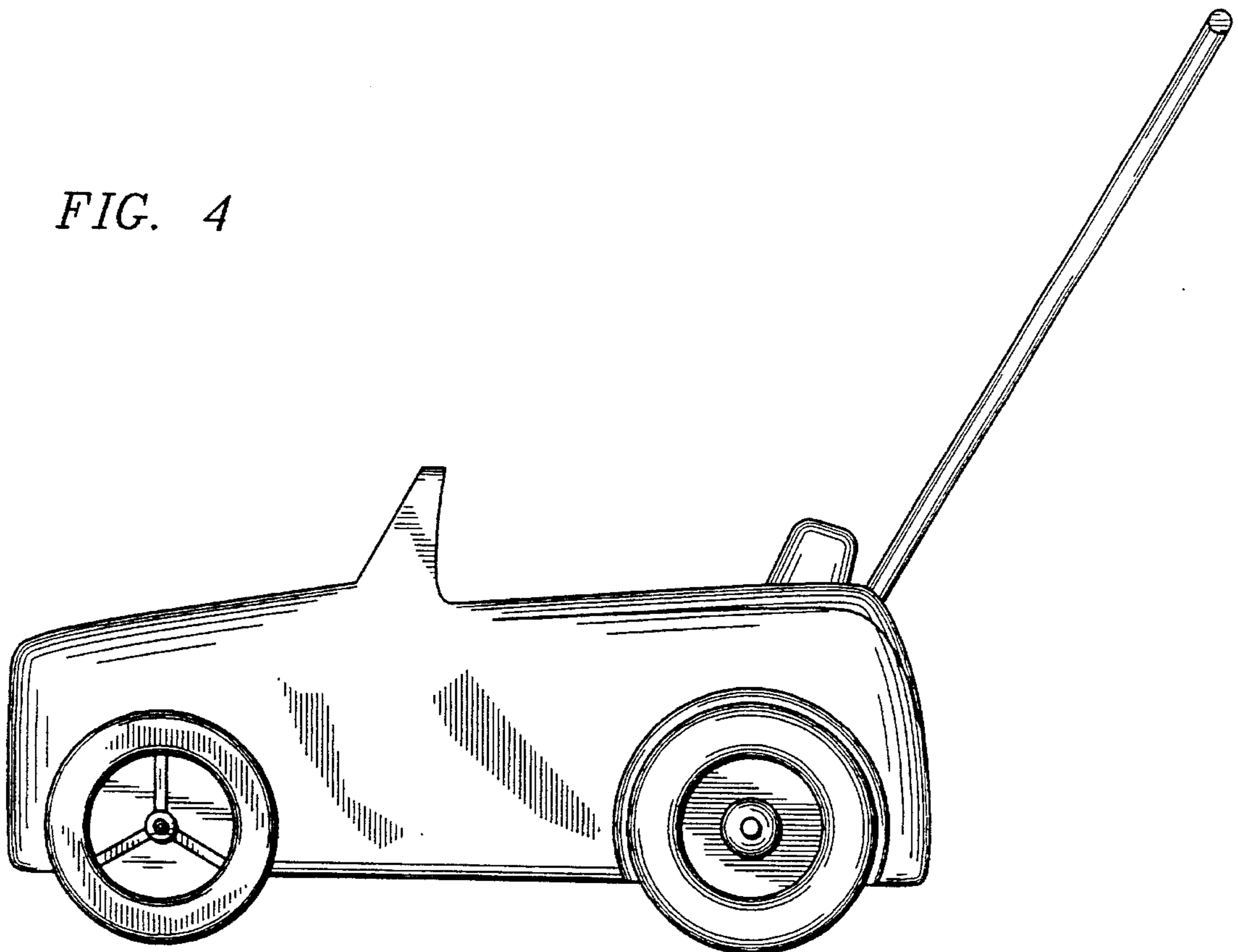

FIG. 5

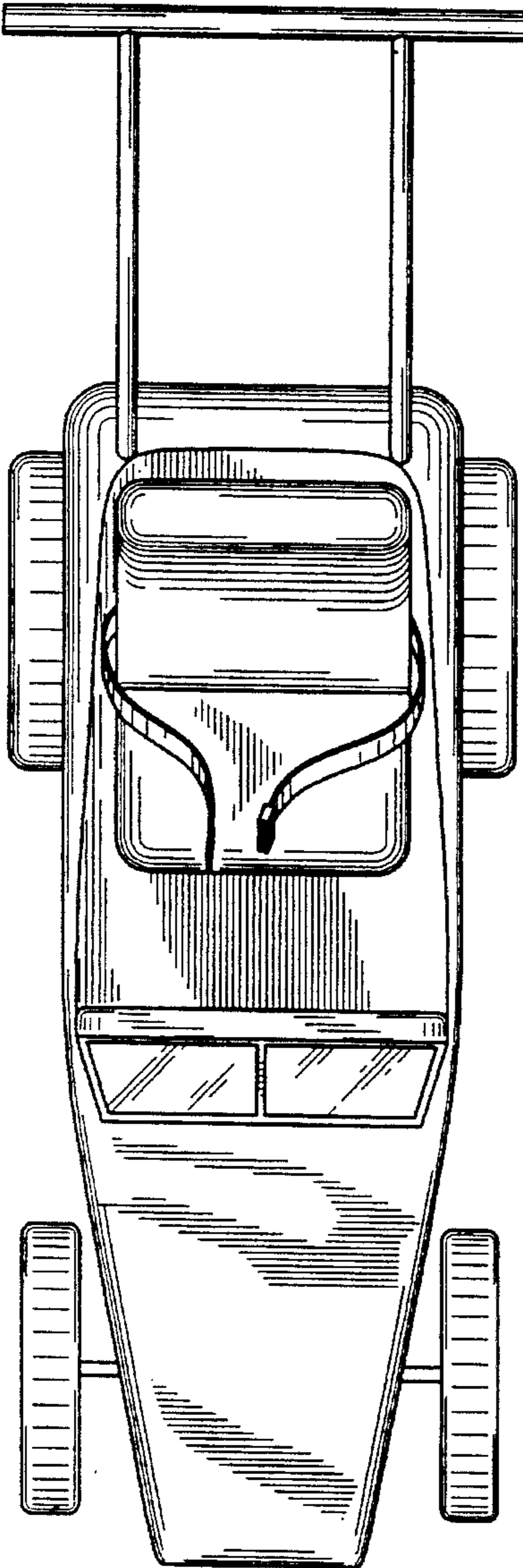
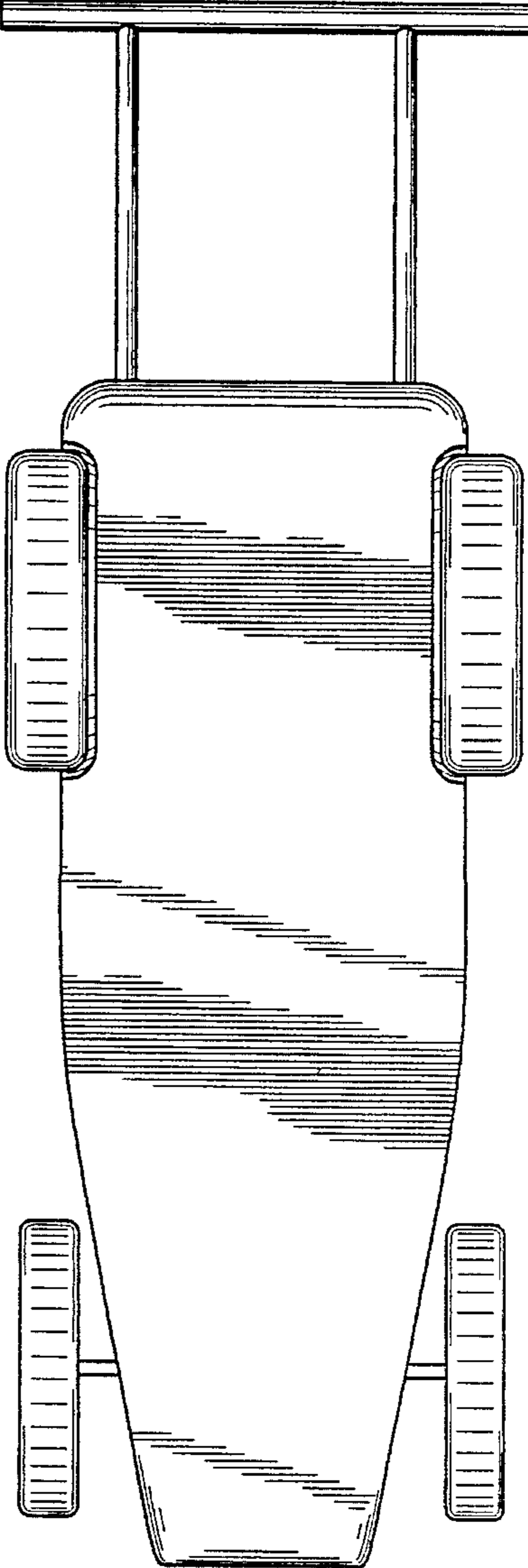

FIG. 6



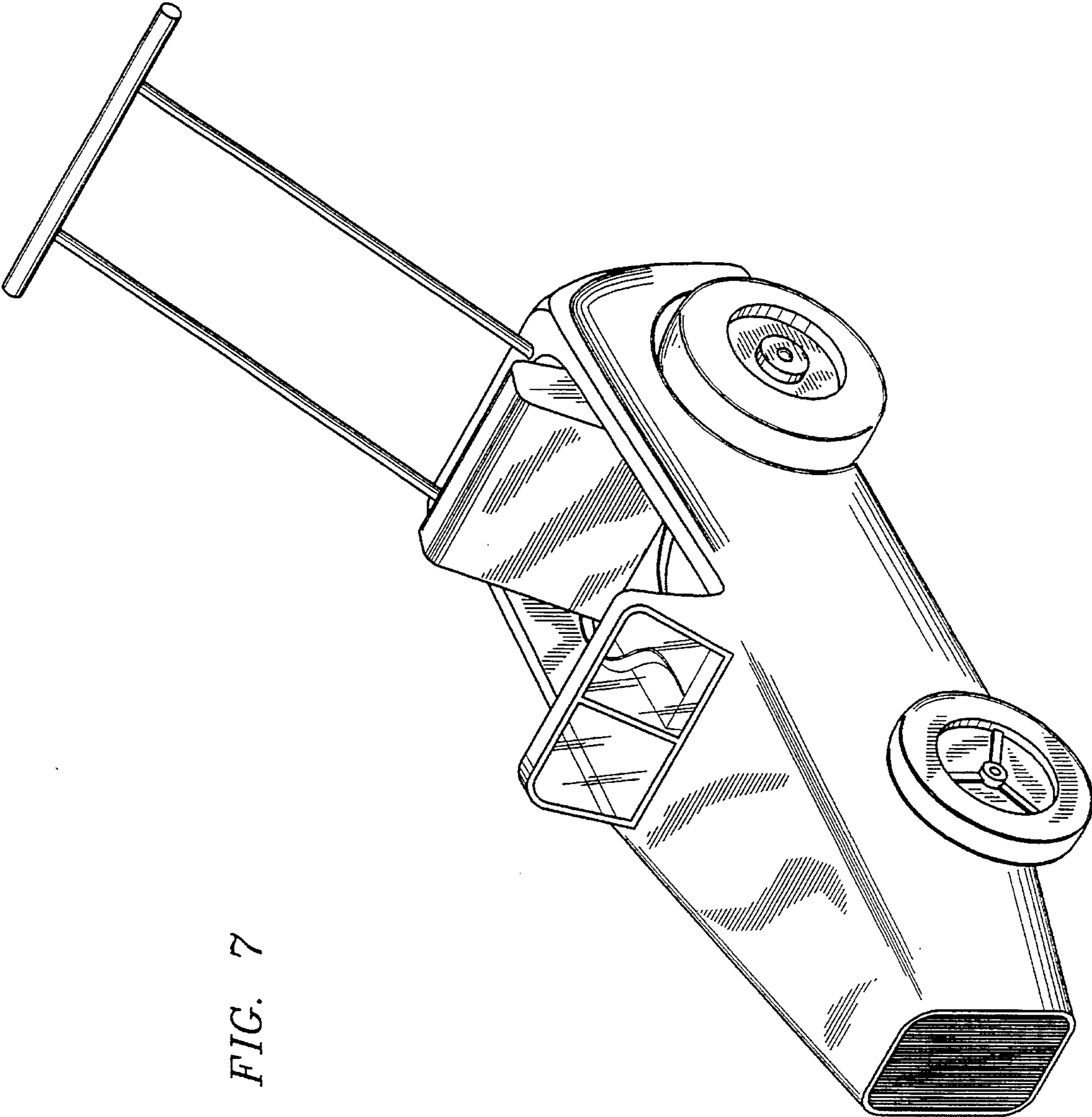

FIG. 7