



US00D369975S

United States Patent [19] Simon

[11] Patent Number: **Des. 369,975**

[45] Date of Patent: ****May 21, 1996**

[54] CONTAINER RIM PROTECTOR DESIGN

3,811,606	5/1974	Higgins	222/570
3,894,650	7/1975	Crump	
4,203,537	5/1980	McAlister	
4,969,570	11/1990	Harvey, Sr.	
5,161,689	11/1992	Balson	220/700

[75] Inventor: **Donald A. Simon**, North Vancouver, Canada

[73] Assignee: **Seguro Projects Inc.**, North Vancouver, Canada

[**] Term: **14 Years**

Primary Examiner—Martie Thompson
Assistant Examiner—Robert M. Spear
Attorney, Agent, or Firm—Hoffman, Wasson & Gitler

[21] Appl. No.: **33,357**

[57] **CLAIM**

[22] Filed: **Jan. 11, 1995**

The ornamental design for a container rim protector, as shown and described.

[52] U.S. Cl. **D9/435**; D9/447

[58] Field of Search D7/391, 398, 629;
D9/434-6, 440, 447, 449, 454; D32/53-4;
215/228, 298, 317; 220/700-1, 733, 294;
222/566, 568, 570-1

DESCRIPTION

[56] **References Cited**

U.S. PATENT DOCUMENTS

D. 207,051	2/1967	Bainbridge	D9/447
D. 276,595	12/1984	Miller	D9/434
D. 341,318	11/1993	Brown	D9/447
D. 348,836	7/1994	McCallum et al.	D9/434
D. 352,455	11/1994	Balson	D9/434
2,591,482	5/1948	Weltlich	
2,611,508	9/1952	Brown	
2,722,347	11/1955	Henke	
2,812,886	11/1957	Weinstein	
2,903,154	9/1959	Hendershot	
3,356,266	12/1967	Pinter, Jr.	
3,401,825	9/1968	Weiss	D9/454 X
3,462,035	8/1969	Grussen	D9/454 X

FIG. 1 is a perspective view of the invention;
FIG. 2 is a front view of the invention;
FIG. 3 is a side view of the invention;
FIG. 4 is a rear view of the invention;
FIG. 5 is a top view of the invention; and
FIG. 6 is a bottom view of the invention;
FIG. 7 is a cross-sectional detail view of the invention drawn along line 7—7 in FIG. 6;
FIG. 8 is a cross-sectional detail view of the invention drawn along line 8—8 in FIG. 6;
FIG. 9 is a cross-sectional detail view of the invention drawn along line 9—9 in FIG. 6; and,
FIG. 10 is a cross-sectional detail view of the invention drawn along line 10—10 in FIG. 6.
The broken line showing of a container is for illustrative purposes only and forms no part of the claimed design.

1 Claim, 6 Drawing Sheets

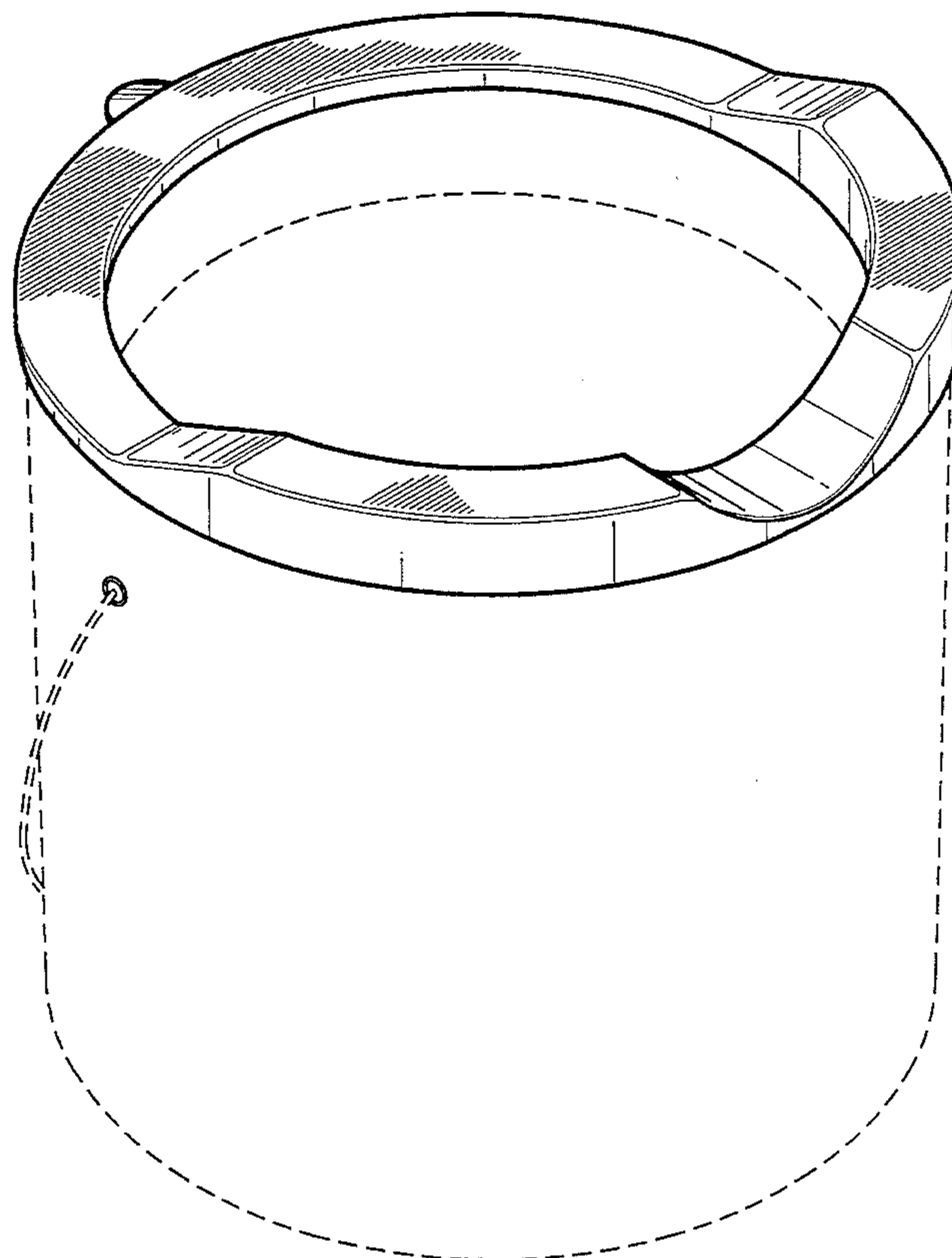

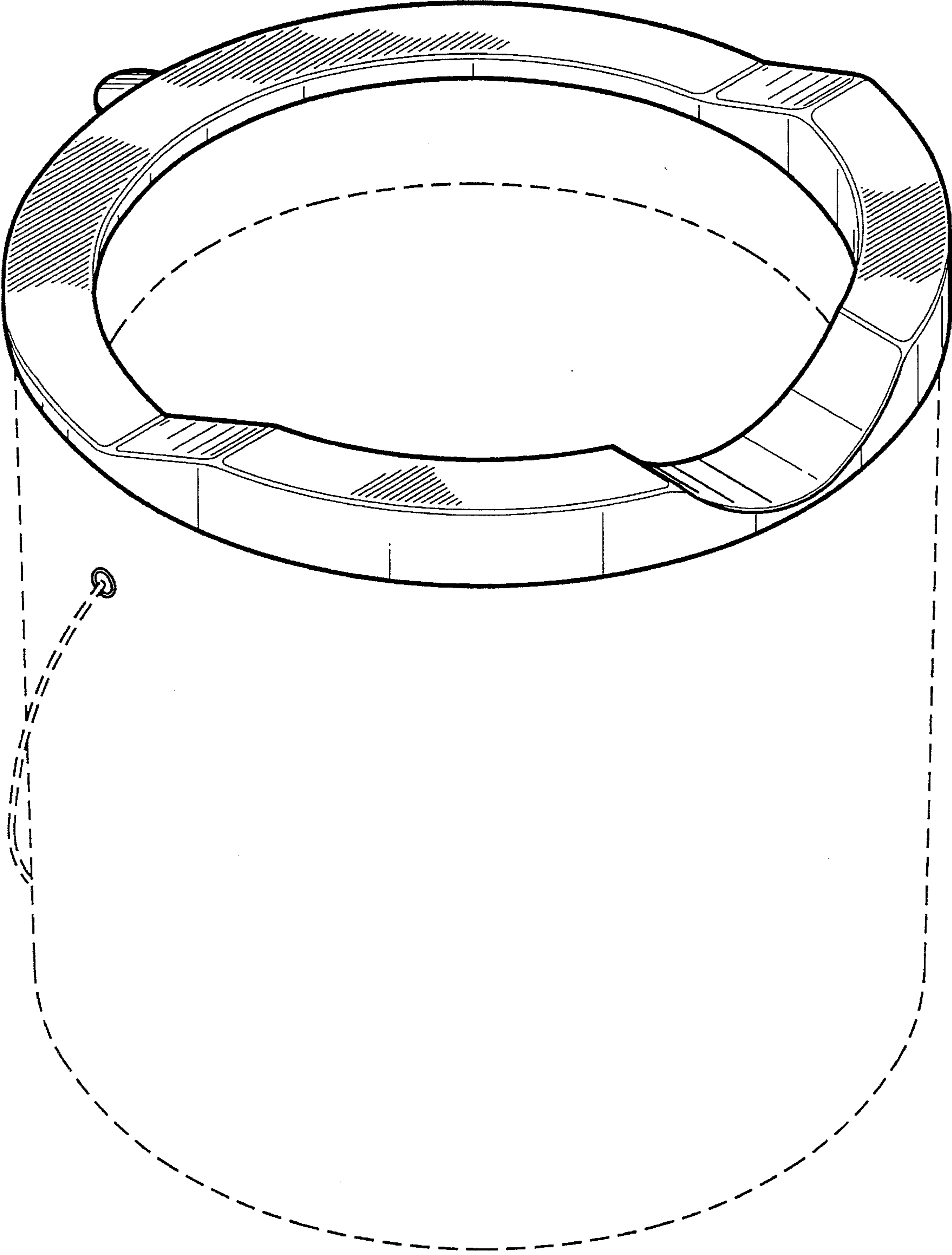

FIG.1



FIG. 2

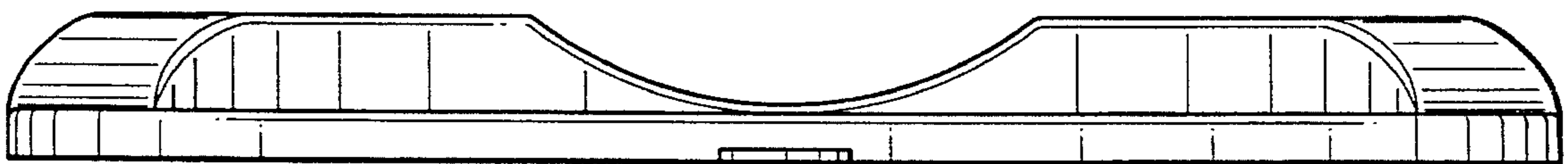

FIG. 4

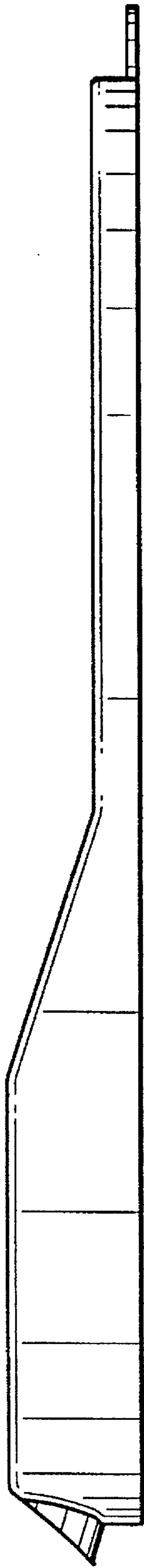

FIG. 3

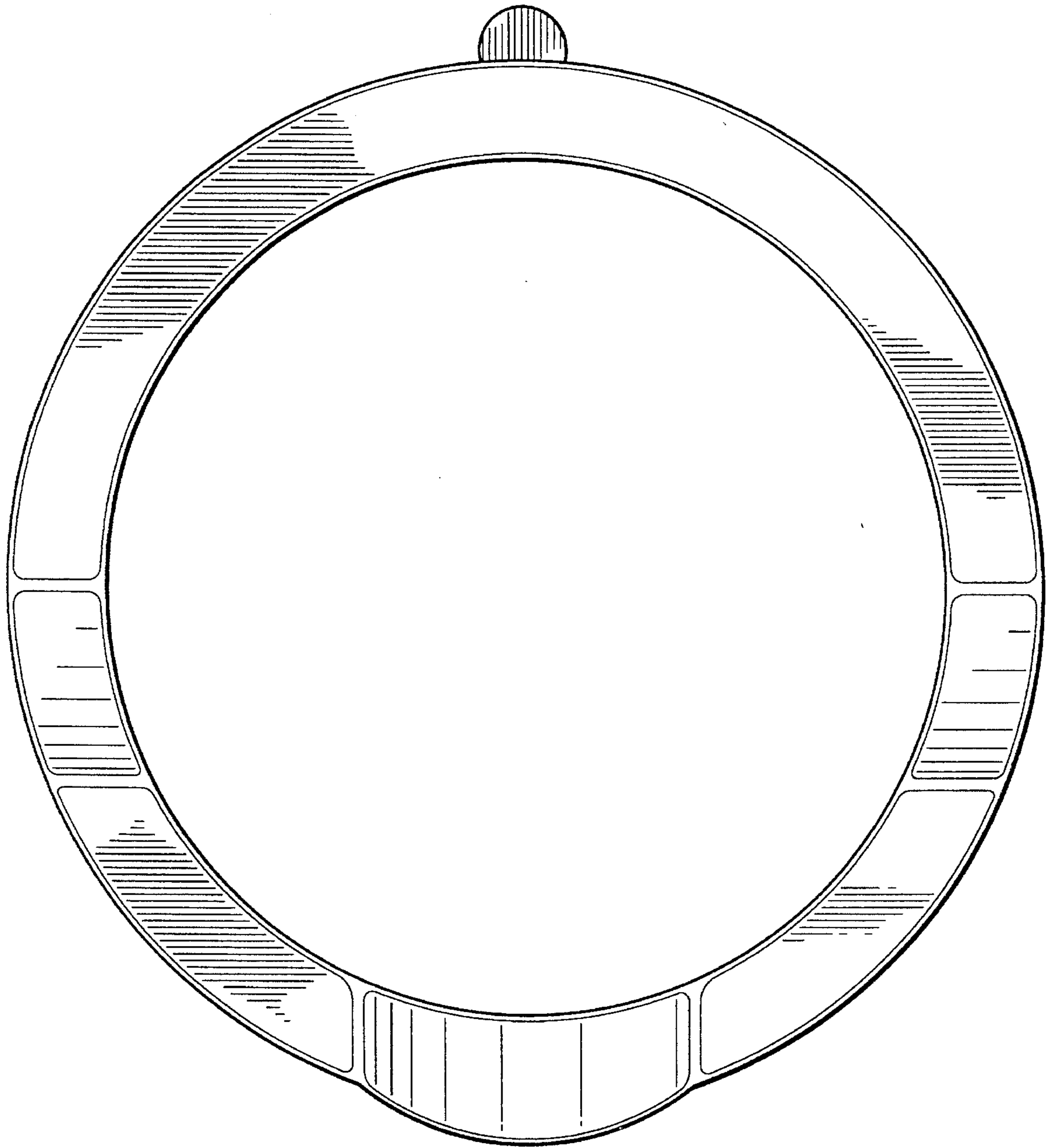

FIG. 5

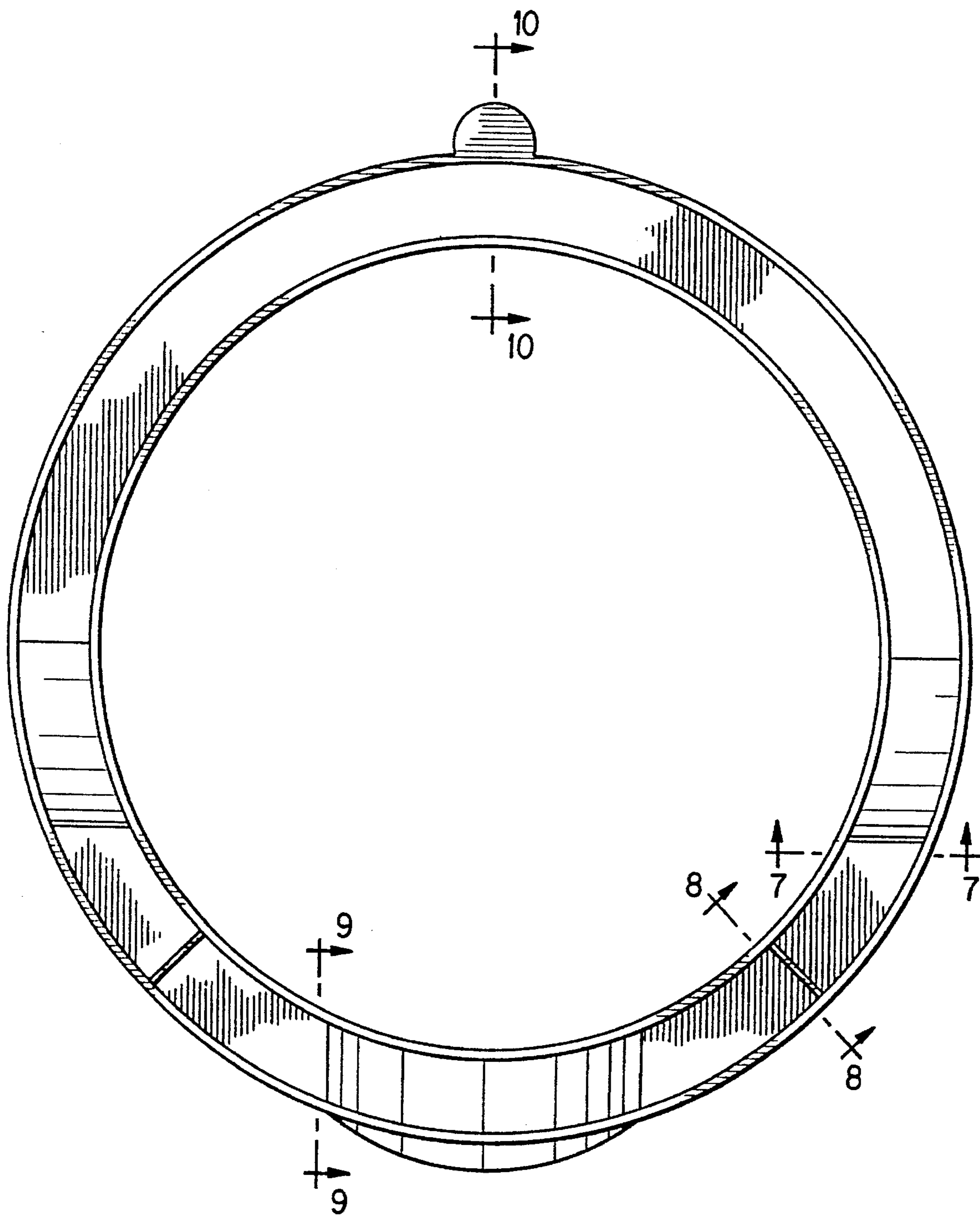

FIG. 6

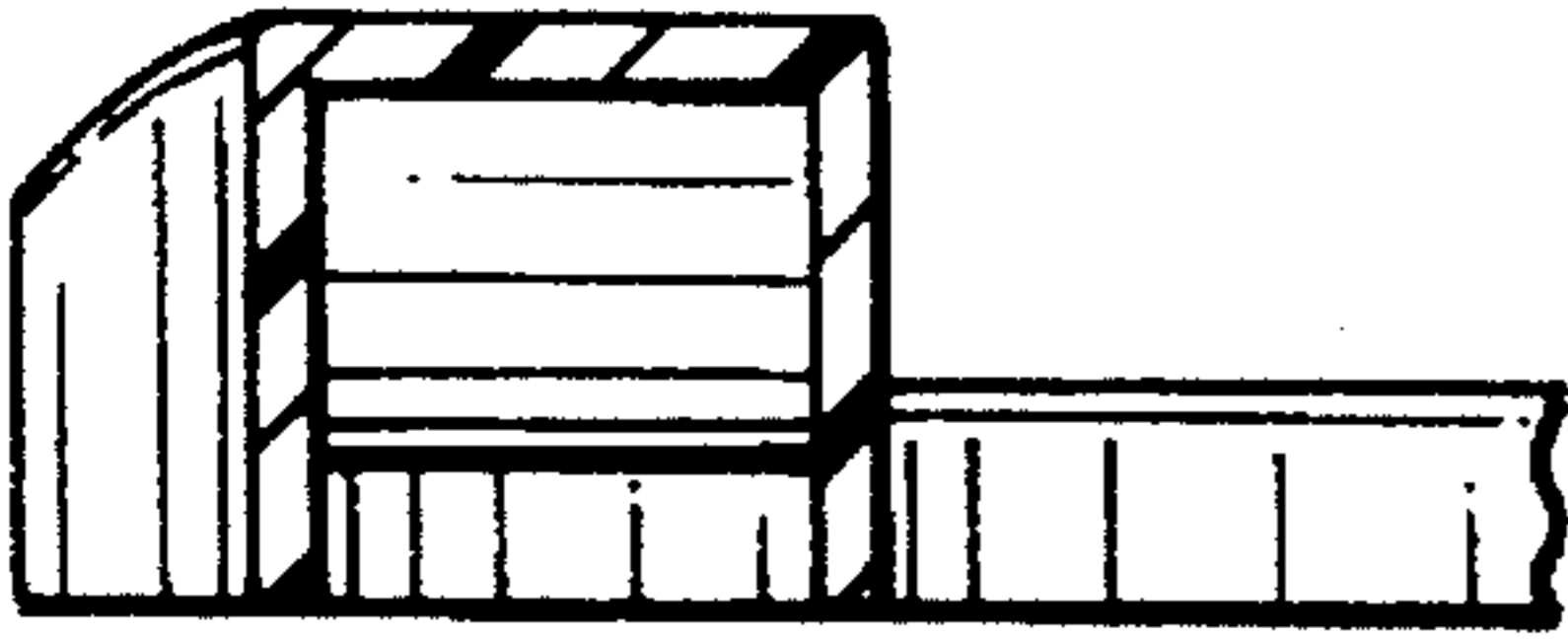

FIG. 7

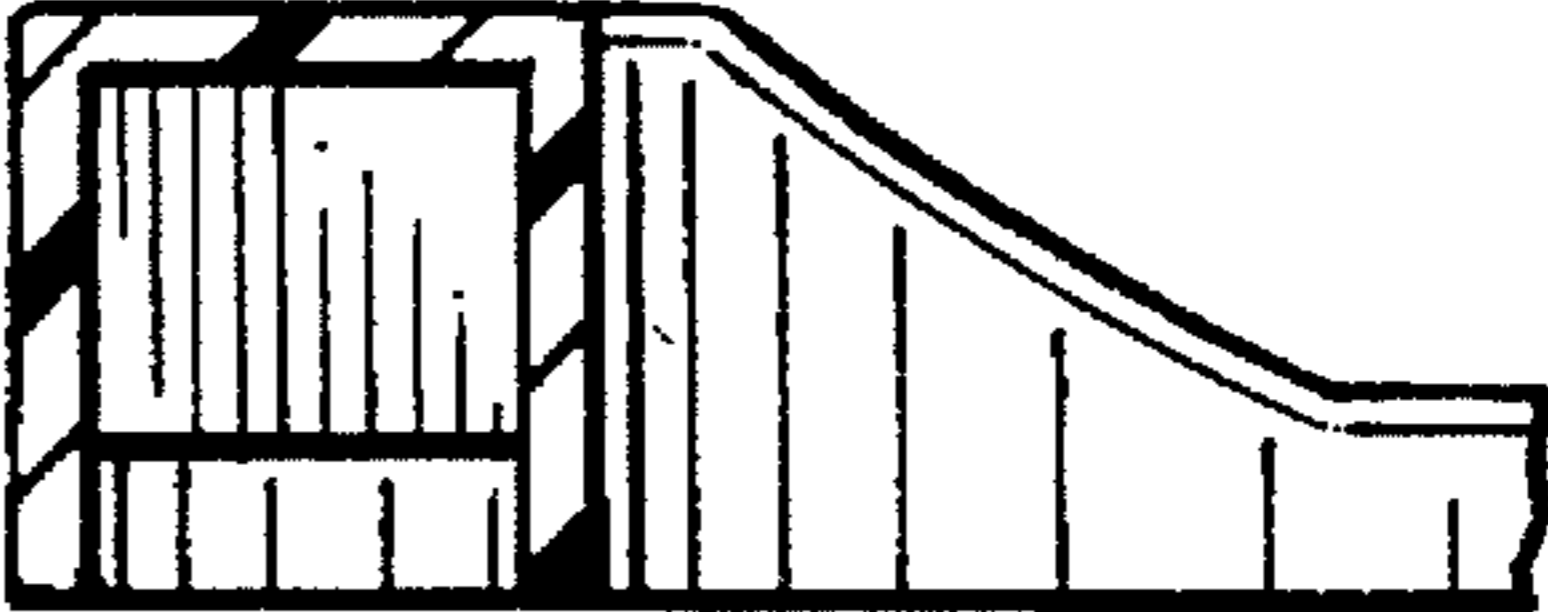

FIG. 8

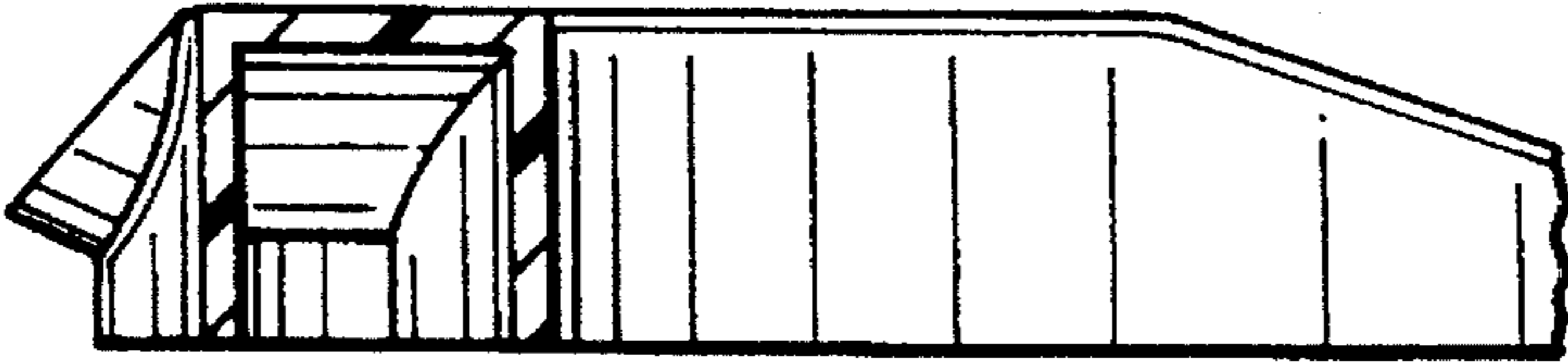

FIG. 9



FIG. 10