



US00D369974S

United States Patent [19] Osaka

[11] Patent Number: **Des. 369,974**

[45] Date of Patent: ****May 21, 1996**

[54] **LID** 2,768,667 10/1956 Hill 206/518
 4,576,330 3/1986 Schepp 220/315
 4,687,129 8/1987 Cugley 220/315
 5,029,721 7/1991 Timpe 220/769

[75] Inventor: **Yuji Osaka**, Tokyo, Japan

[73] Assignee: **Osaka Co., Ltd.**, Osaka, Japan

[**] Term: **14 Years**

[21] Appl. No.: **32,076**

[22] Filed: **Dec. 5, 1994**

[30] **Foreign Application Priority Data**

Jun. 13, 1994 [JP] Japan 6-17286

[52] **U.S. Cl.** **D9/435**

[58] **Field of Search** D7/396.1, 538;
 D9/434-5, 439, 444-5, 452; D34/7, 11;
 190/1, 10, 11; 206/508, 518; 211/126; 220/306,
 315, 769; 312/231, 237, 270

OTHER PUBLICATIONS

Pyrex Golden Casserole lid, supplement to *Home Furnishings Daily*, Jan. 12, 1960, p. 2.
 Eagle Micromasters covered rectangular pan lid, *Retailing Home Furnishings*, Sec. 3, Jan. 16, 1978, p. 14.
 18"×12" Box Lid, *Rubbermaid Food Service Catalog*, ©1981, p. 10.
 Tupperware Pick-A-Deli Container Lid, Tupperware Catalog, p. 30.
 Lid to Sterilite Storage Box No. 1652, *Sterilite* advertising flyer.

Primary Examiner—Alan P. Douglas
Assistant Examiner—Robert M. Spear
Attorney, Agent, or Firm—Foley & Lardner

[56] References Cited

U.S. PATENT DOCUMENTS

D. 65,729 10/1924 Connor D9/434
 D. 102,555 12/1936 Holland D9/434
 D. 246,566 12/1977 Van Skiver D34/11
 D. 248,091 6/1978 Fryendal D9/439
 D. 254,958 5/1980 Dugan et al. D9/435
 D. 257,939 1/1981 Conti D9/435
 D. 270,200 8/1983 Creske D34/7
 D. 284,944 8/1986 Carlson D9/435
 D. 327,348 6/1992 Skorheim D34/11
 D. 335,562 5/1993 Evans D34/7
 D. 337,190 7/1993 Juergens D34/11
 D. 340,761 10/1993 Long D9/455
 D. 348,377 7/1994 Douglas D7/538

[57] CLAIM

The ornamental design for a lid, as shown and described.

DESCRIPTION

FIG. 1 is a top plan view of a lid showing the new design;
 FIG. 2 is a front elevation thereof;
 FIG. 3 is a rear elevation thereof;
 FIG. 4 is a bottom plan view thereof;
 FIG. 5 is a left side elevation thereof;
 FIG. 6 is a right side elevation thereof; and,
 FIG. 7 is a sectional view thereof taken along the line 7—7 of FIG. 1.

1 Claim, 3 Drawing Sheets

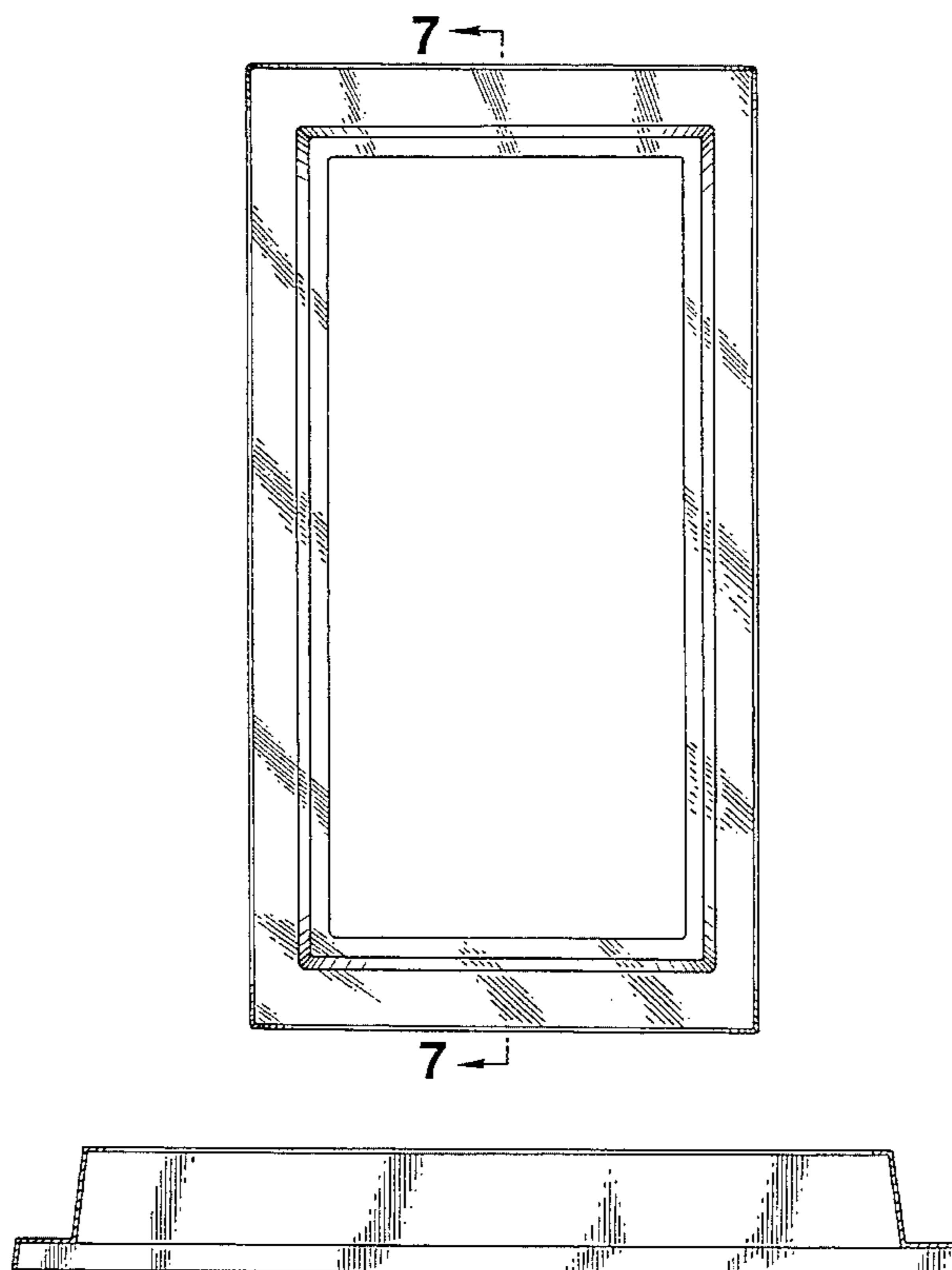
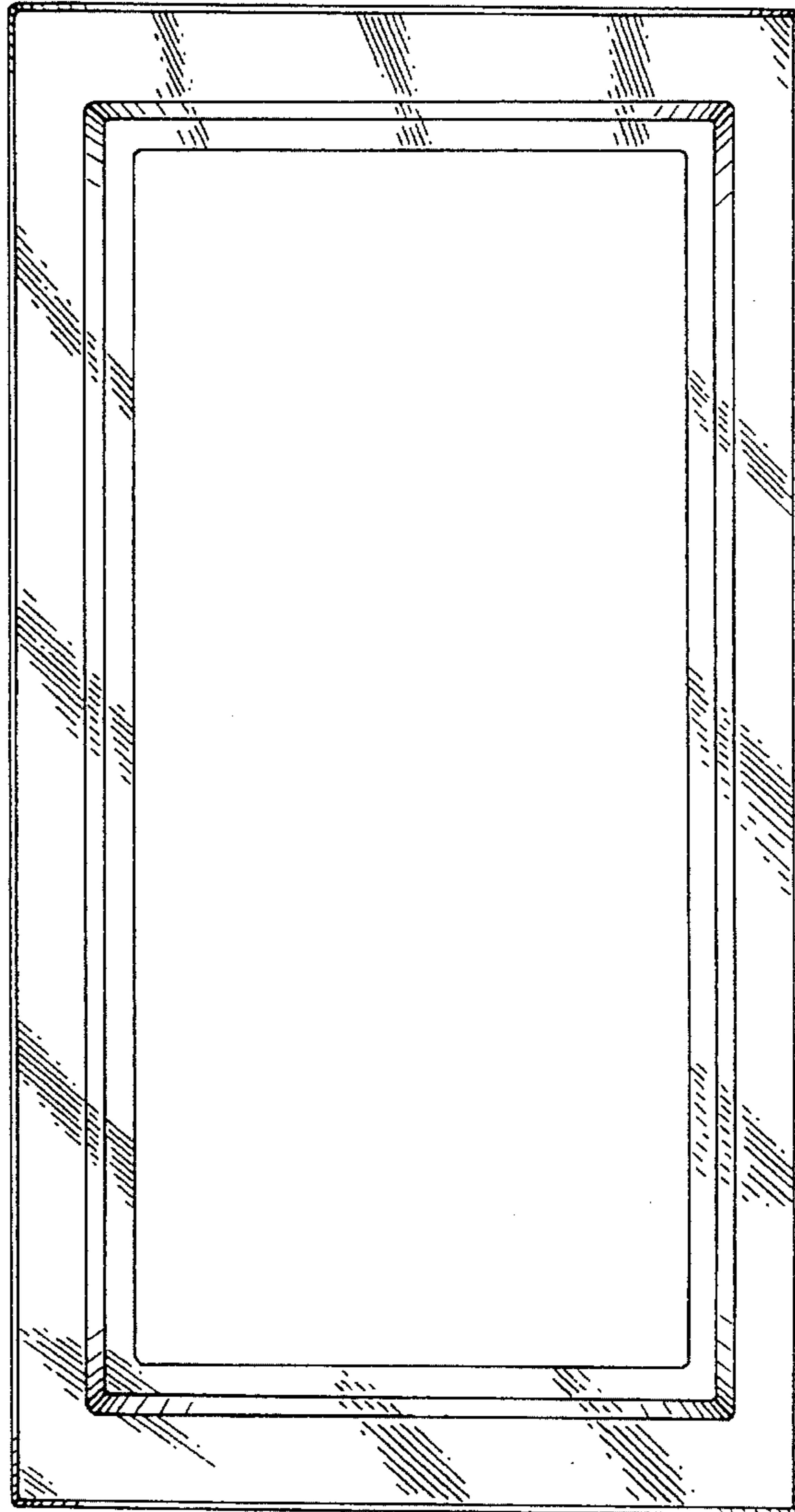

FIG.1

7 ←



7 ←

FIG.2

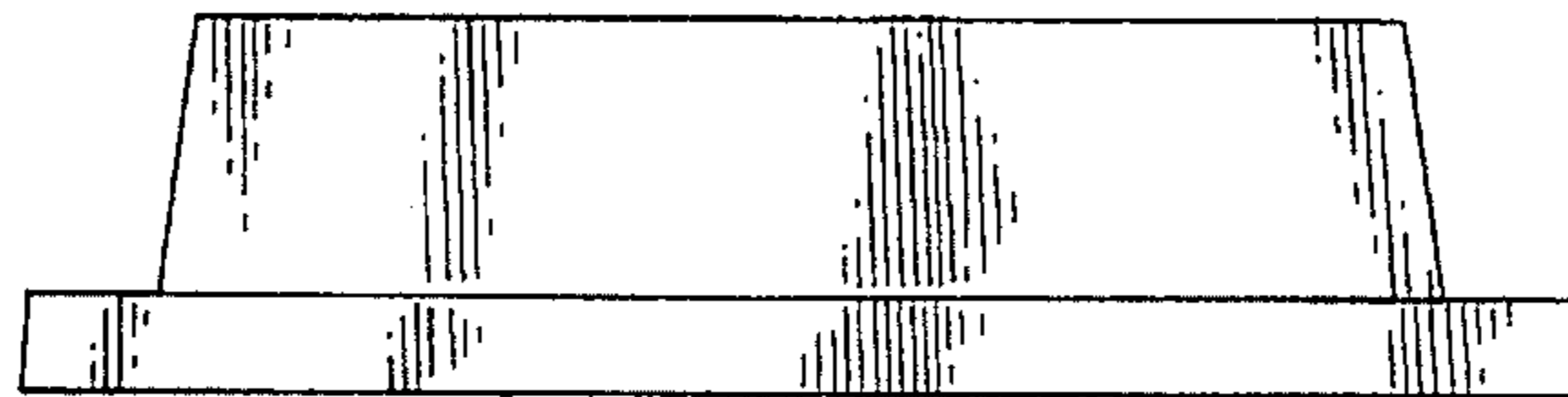

FIG.3

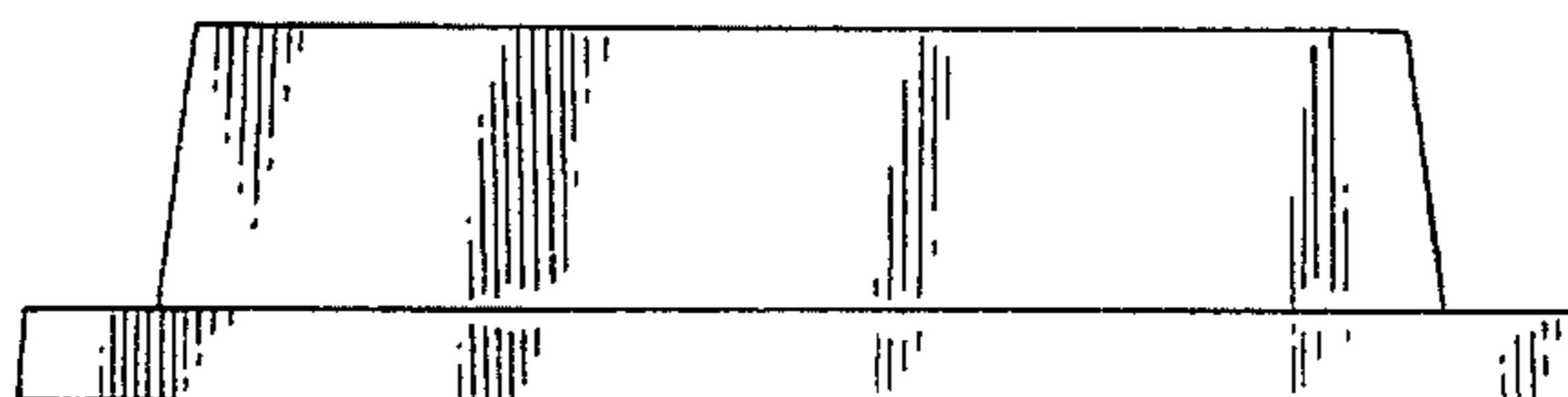

FIG.4

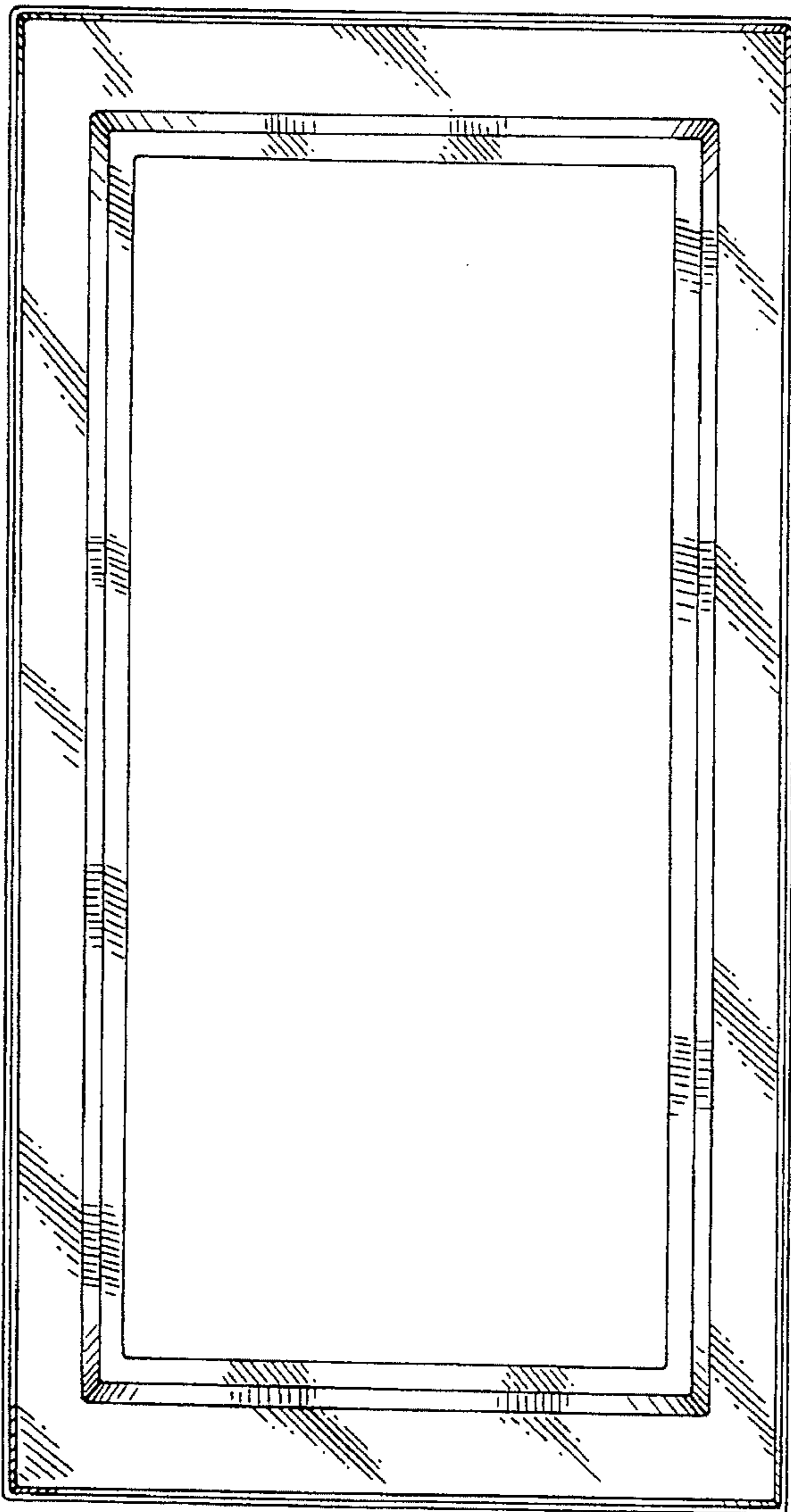

FIG.5

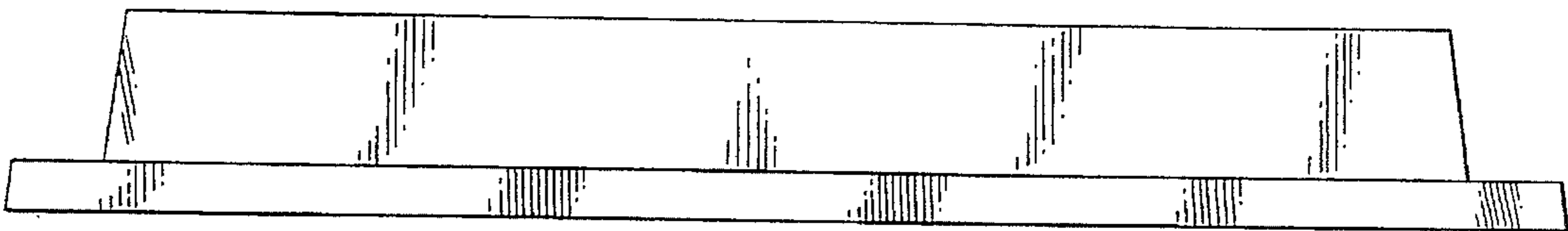

FIG.6

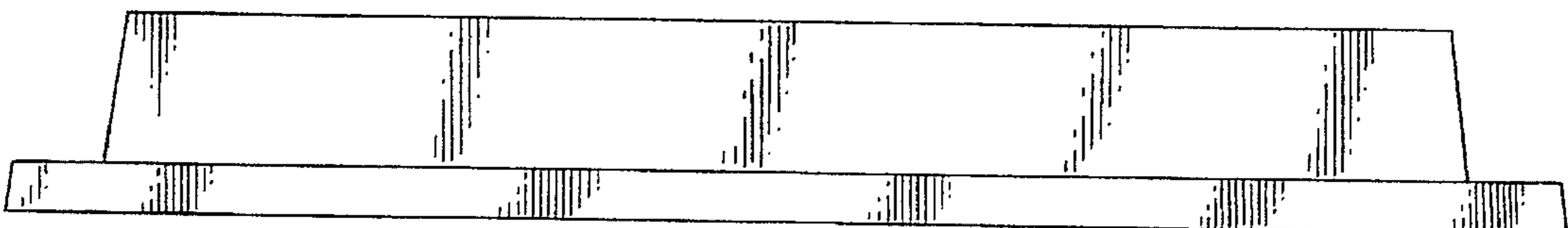

FIG. 7

