



US00D369799S

United States Patent [19]

Kong et al.

[11] Patent Number: **Des. 369,799**

[45] Date of Patent: ****May 14, 1996**

[54] **CORDLESS TELEPHONE BASE HOUSING**

D. 360,398 7/1995 Nagele et al. D13/108

[75] Inventors: **Pang C. Kong; Ho C. Kong; Wong F. Shan**, all of Hong Kong, Hong Kong

[73] Assignee: **Vtech Communications Ltd.**, Hong Kong, Hong Kong

[**] Term: **14 Years**

[21] Appl. No.: **33,106**

[22] Filed: **Jan. 5, 1995**

[52] U.S. Cl. **D14/149**

[58] Field of Search D14/100, 101, D14/149, 140, 150, 151, 141, 142, 144, 240, 241, 138, 137, 148, 147; D13/107, 108; 379/433-436, 440, 428, 419, 420

[56] **References Cited**

U.S. PATENT DOCUMENTS

D. 301,236	5/1989	Suzui et al.	D14/142
D. 306,295	2/1990	Nagele	D14/149
D. 318,051	7/1991	Danielson et al.	D14/149 X
D. 319,829	9/1991	Wu	D14/151
D. 349,899	8/1994	Siddoway et al.	D14/151
D. 352,283	11/1994	Schmidt	D14/151
D. 355,190	2/1995	Folkes et al.	D14/149
D. 358,387	5/1995	Tokiyama	D14/149
D. 359,284	6/1995	Hung	D14/151

OTHER PUBLICATIONS

B. A. Pargh 1985 Spring/Summer Catalog, p. 272, Sanyo TH1015.

B. A. Pargh 1992 Spring/Summer Catalog, p. 316, Southwestern Bell Freedom Phone, 2nd from bottom at right.

Primary Examiner—Jeffrey Asch
Attorney, Agent, or Firm—Dick and Harris

[57] **CLAIM**

The ornamental design for a cordless telephone base housing, as described and shown.

DESCRIPTION

FIG. 1 is a top plan view showing the cordless telephone base housing of our new ornamental design; FIG. 2 is a bottom view of thereof; FIG. 3 is a right side elevation thereof; FIG. 4 is a left side elevation thereof; FIG. 5 is a rear elevation thereof; FIG. 6 is a front elevation of thereof; and, FIG. 7 is a perspective view thereof.

The antenna illustrated by means of broken lines in the Figures is provided for illustrative purposes only and forms no part of the claimed design.

1 Claim, 3 Drawing Sheets

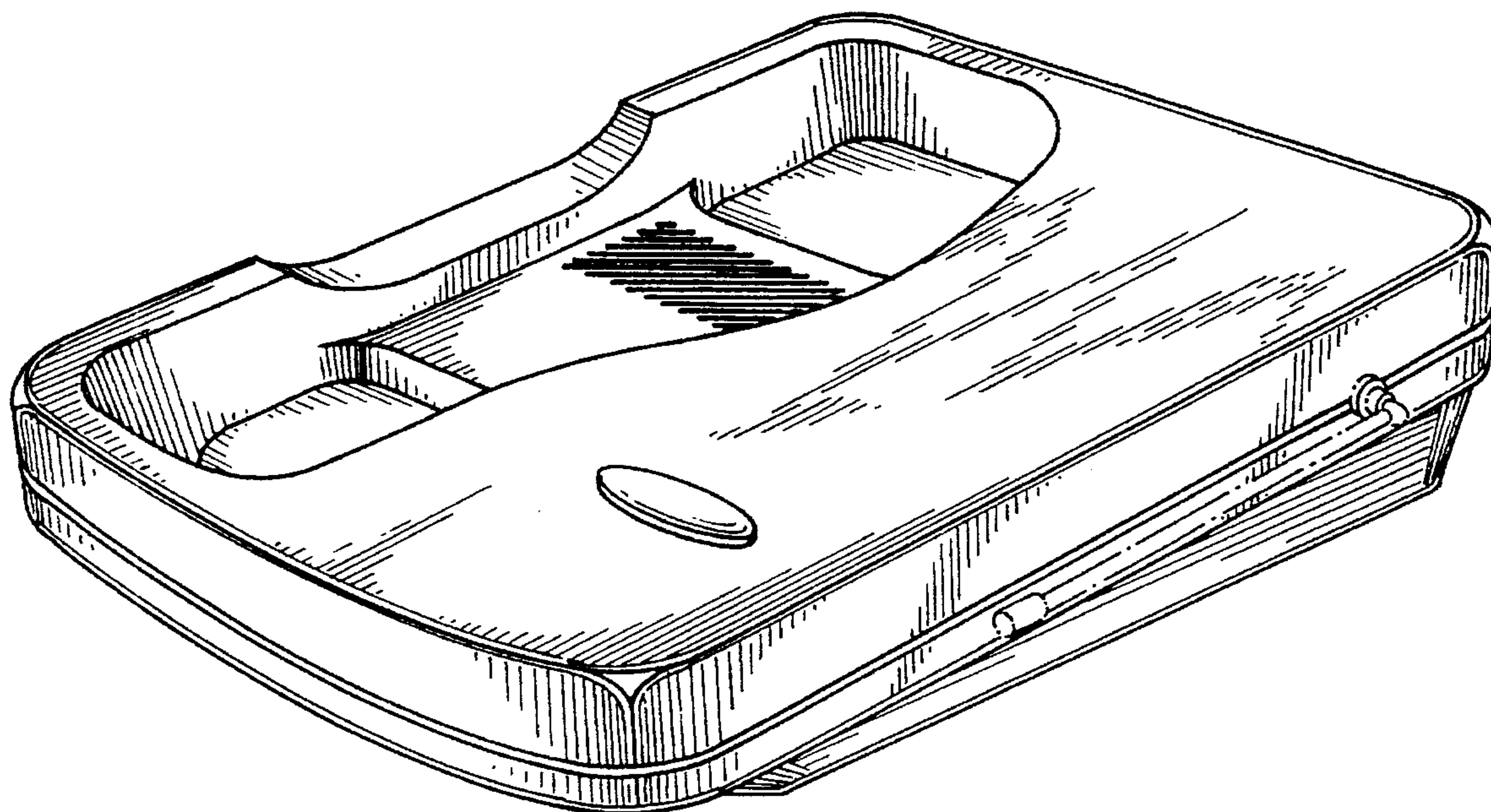

Fig 1

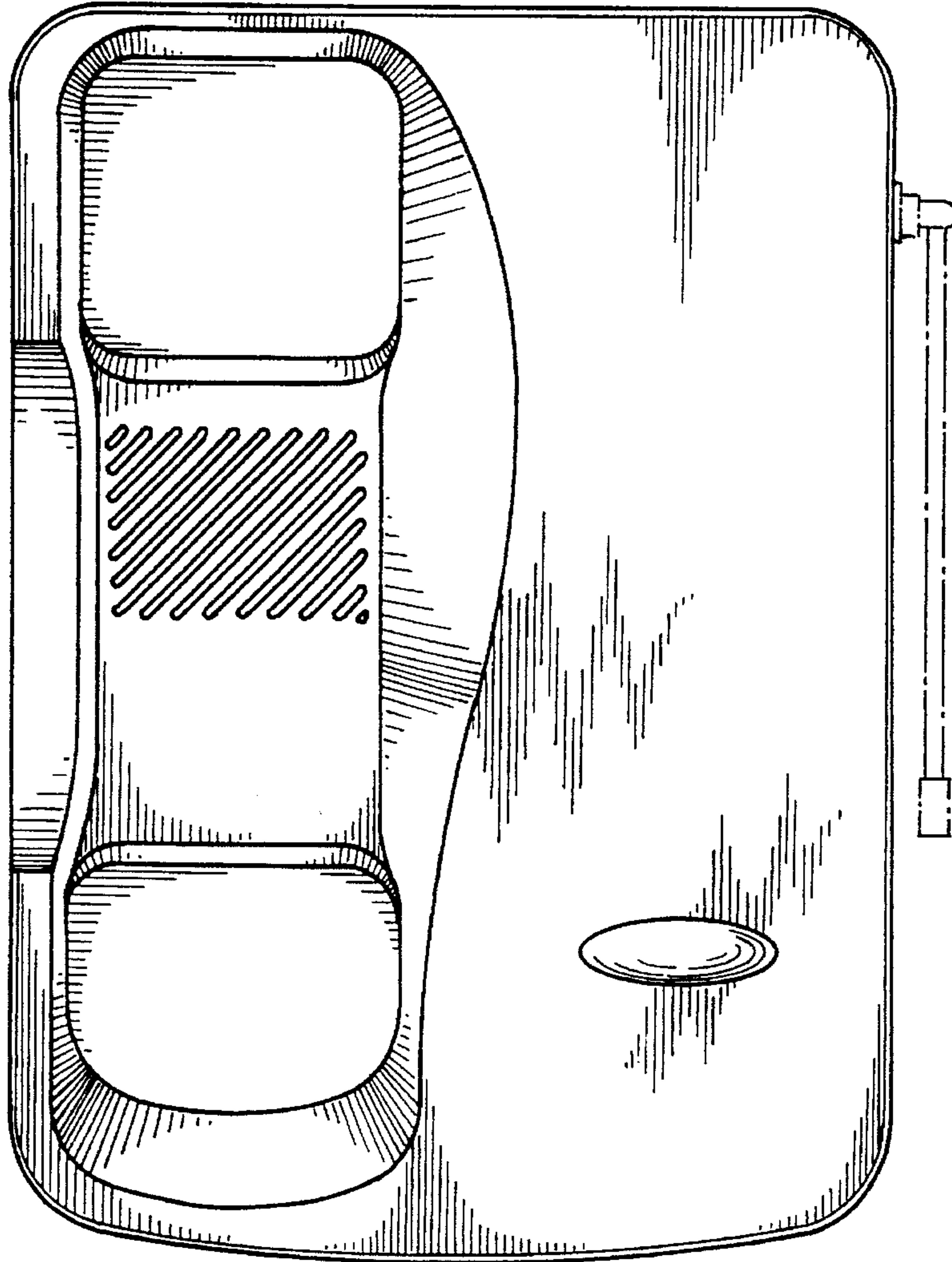

Fig 3

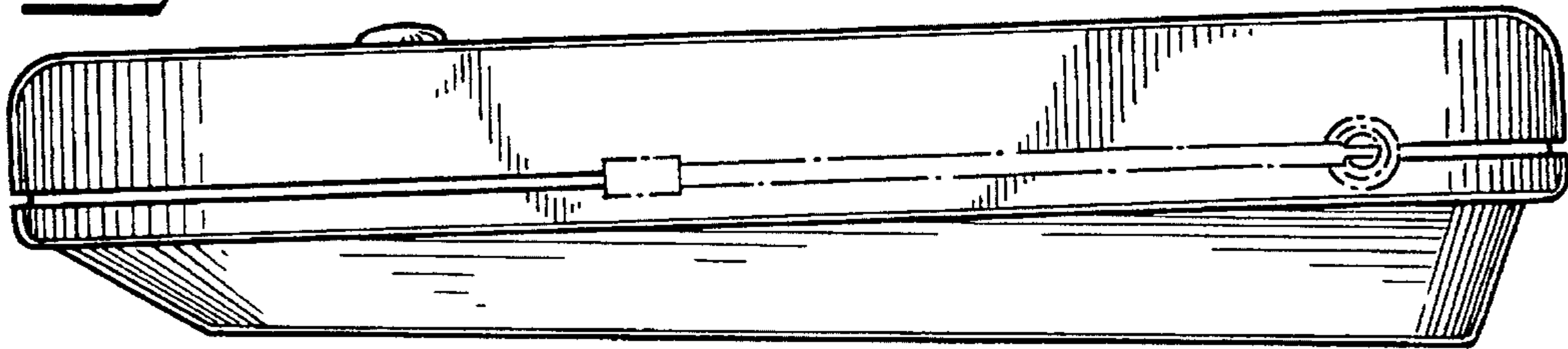

Fig 4

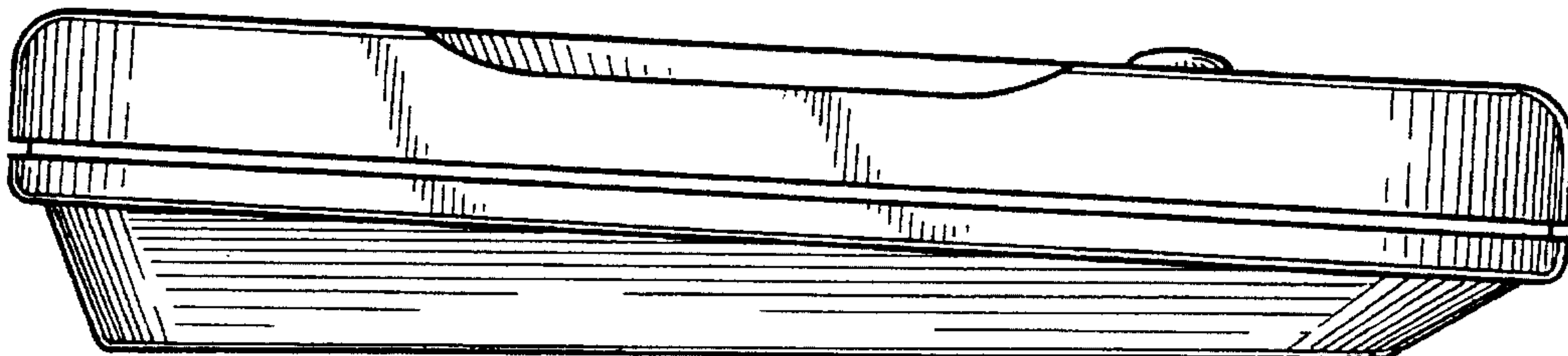

Fig 2

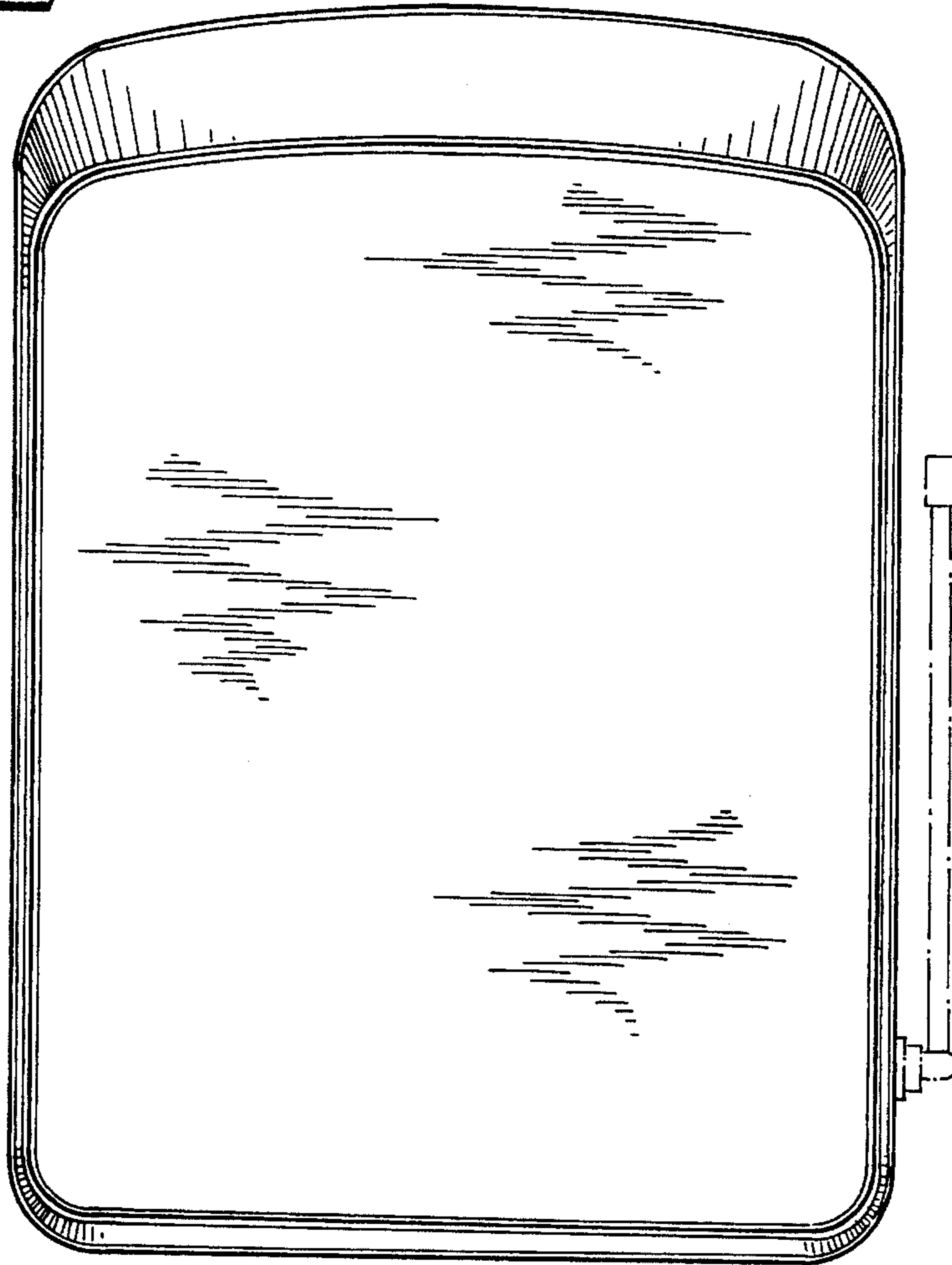

Fig 5

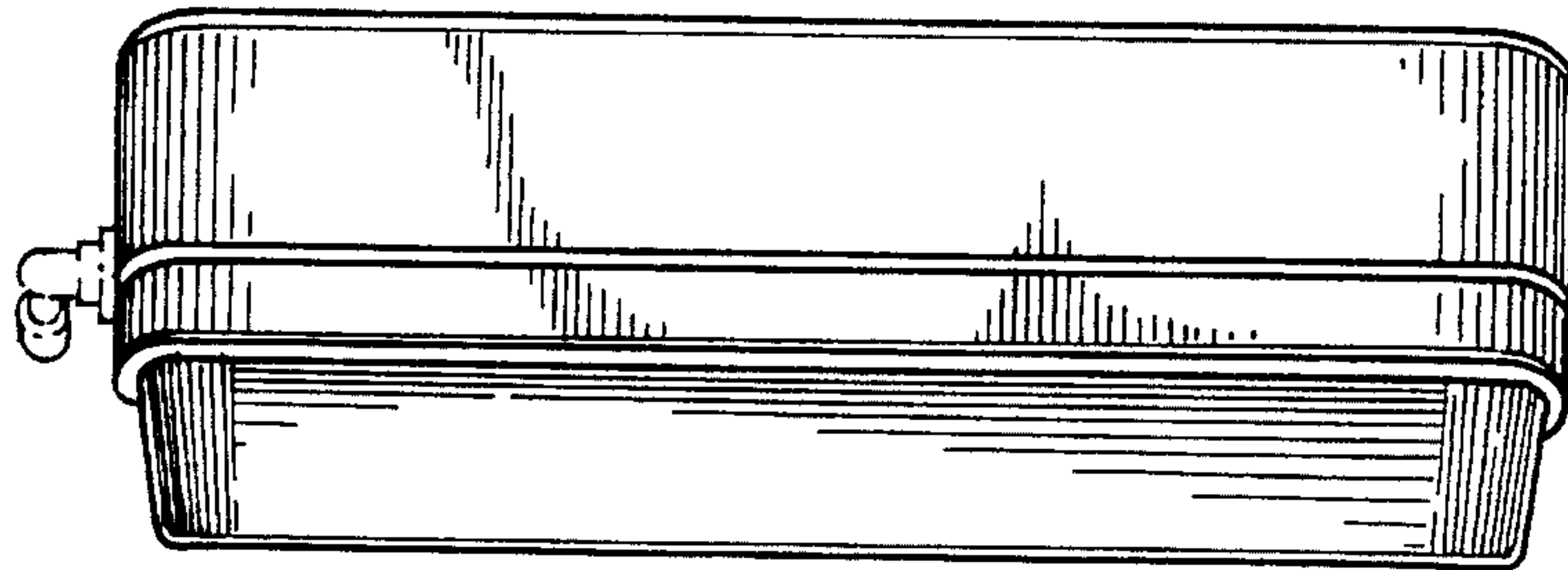

Fig 6

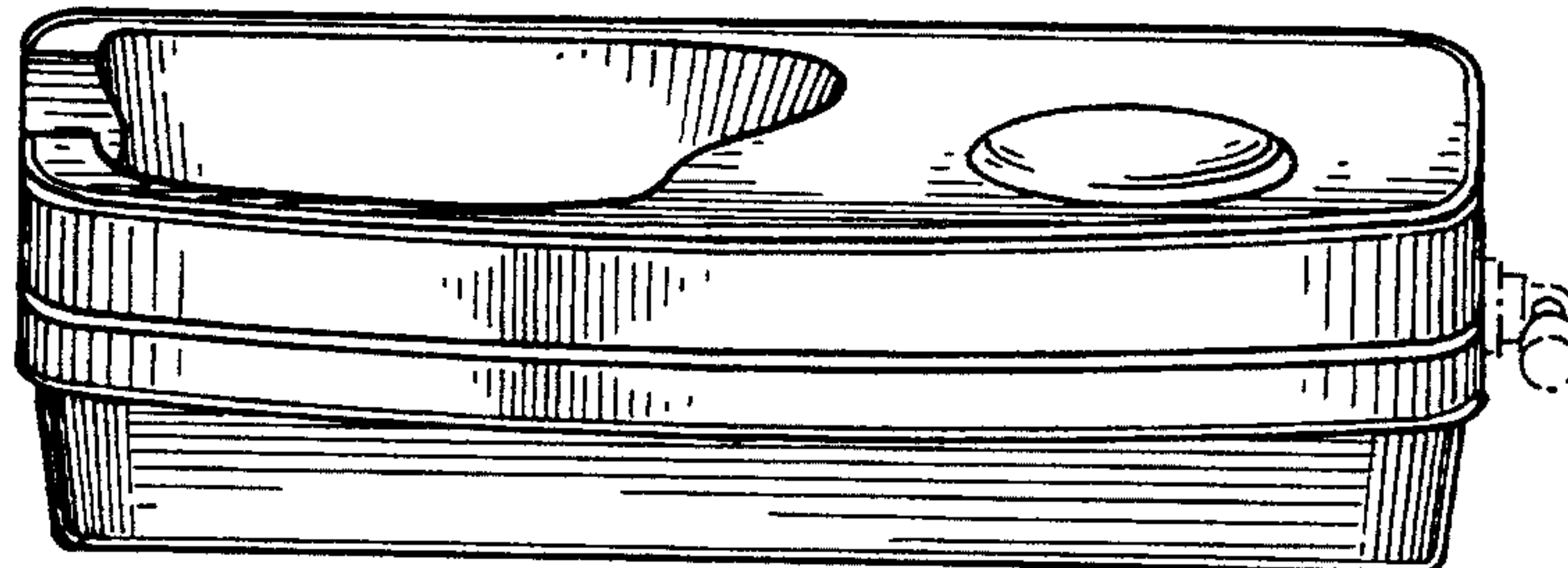

Fig 7

