



US00D369761S

United States Patent [19]

[11] Patent Number: **Des. 369,761**

Weder et al.

[45] Date of Patent: ***** May 14, 1996**

[54] **FLOWER POT COVER**

[75] Inventors: **Donald E. Weder; Joseph G. Straeter,**
both of Highland, Ill.

[73] Assignee: **Highland Supply Corporation,**
Highland, Ill.

[*] Notice: The portion of the term of this patent
subsequent to Jan. 16, 2010, has been
disclaimed.

[**] Term: **14 Years**

[21] Appl. No.: **3,196**

[22] Filed: **Jan. 5, 1993**

Related U.S. Application Data

[63] Continuation-in-part of Ser. No. 807,904, Dec. 16, 1991,
which is a continuation-in-part of Ser. No. 710,272, Jun. 4,
1991, which is a continuation-in-part of Ser. No. 617,454,
Nov. 21, 1990, abandoned, Ser. No. 411,245, Sep. 22, 1989,
Ser. No. 411,247, Sep. 22, 1989, and Ser. No. 411,249, Sep.
22, 1989, Pat. No. Des. 358,113.

[52] U.S. Cl. **D11/164; D11/143**

[58] Field of Search D11/143, 149,
D11/152-156, 164, 89, 90; 47/66, 72; 206/423;
215/100.5; 229/1.5 R, 1.5 B, 4.5, 87.01,
922, 930, 108, 108.1, 109, 110, 400; 428/27,
35.1, 24, 542.6; D9/346, 428-431; D27/102,
133; D26/128-136; D19/96; D7/540, 584,
586, 587, 354

[56] **References Cited**

U.S. PATENT DOCUMENTS

D. 51,108	8/1917	Fulper	D11/154
D. 147,720	10/1947	Dean	D21/133
D. 159,946	9/1950	Bartley	D27/133
D. 292,182	10/1987	Weder et al.	D11/164
D. 292,562	11/1987	Weder et al.	D11/164
D. 293,224	12/1987	Weder et al.	D11/164
D. 293,775	1/1988	Weder et al.	D11/164
D. 316,060	4/1991	Weder et al.	D11/164
D. 317,583	6/1991	Weder et al.	D11/164
D. 318,030	7/1991	Weder et al.	D11/164
D. 327,234	6/1992	Vaughn	D11/143

1,065,486	6/1913	Washburn	229/400
2,054,934	9/1936	Graffenberger	229/1.5 B
2,102,510	12/1937	Cecil, 2d	229/1.5 B
2,355,559	8/1944	Renner	229/8
4,043,077	8/1977	Stonehocker	206/423 X
5,127,817	7/1992	Weder et al.	425/383

FOREIGN PATENT DOCUMENTS

103316	3/1938	Australia	229/922
5042958	2/1993	Japan	229/87.01

OTHER PUBLICATIONS

Haeger Potteries Inc., p. 9, Item R1400-C-6" Fluted Bowl.
L'Architecture D'Aujourd'Hui, Apr. 1984, p. 104, Flor
Article 2nd from top.
Exhibit A-Speed Cover® Brochure-The Simple Solution .
. . . , ©1989.

Primary Examiner—Jeffrey Asch
Attorney, Agent, or Firm—Dunlap & Codding

[57] **CLAIM**

The ornamental design for a flower pot cover, as shown and
described.

DESCRIPTION

FIG. 1 is a perspective view of our new flower pot cover
design;
FIG. 2 is a left side elevational view thereof;
FIG. 3 is a right side elevational view thereof;
FIG. 4 is a front side elevational view thereof;
FIG. 5 is a back side elevational view thereof;
FIG. 6 is a top plan view thereof;
FIG. 7 is a bottom plan view thereof;
FIG. 8 is a side elevational view of the design of FIG. 1, the
only difference being in the horizontal angle of the skirt;
FIG. 9 is a side elevational view of the design of FIG. 1, the
only difference being in the downward angle of the skirt;
FIG. 10 is a side elevational view of the design of FIG. 1,
the only difference being in the near vertical angle of the
skirt;
FIG. 11 is a perspective view of a second embodiment of our
new flower pot cover design;
FIG. 12 is a left side elevational view thereof;
FIG. 13 is a right side elevational view thereof;
FIG. 14 is a front side elevational view thereof;

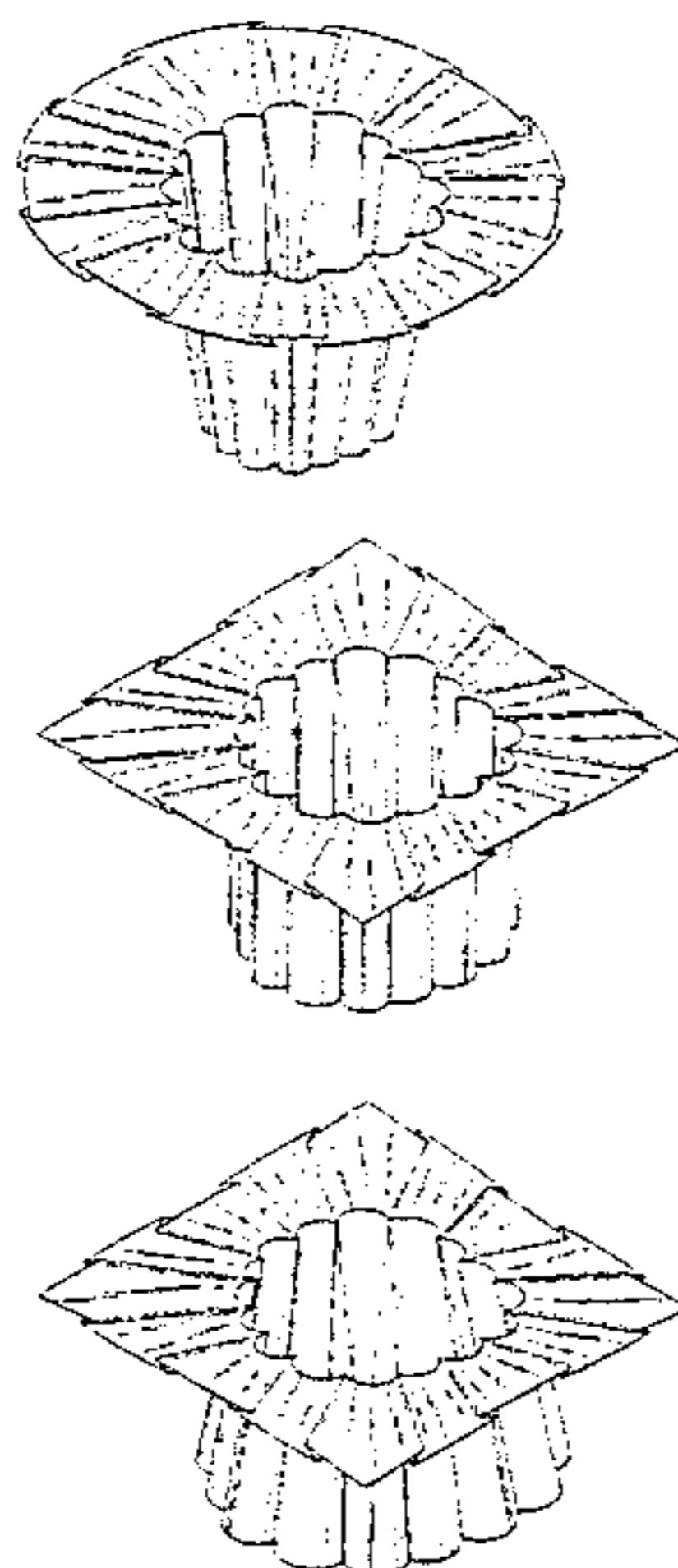

FIG. 15 is a back side elevational view thereof;
FIG. 16 is a top plan view thereof;
FIG. 17 is a bottom plan view thereof;
FIG. 18 is a side elevational view of the design of FIG. 11, the only difference being in the horizontal angle of the skirt;
FIG. 19 is a side elevational view of the design of FIG. 11, the only difference being in the near vertical angle of the skirt;
FIG. 20 is a side elevational view of the design of FIG. 11, the only difference being in the downward angle of the skirt;
FIG. 21 is a perspective view of a third embodiment of our new flower pot cover design;
FIG. 22 is a left side elevational view thereof;
FIG. 23 is a right side elevational view thereof;
FIG. 24 is a front side elevational view thereof;
FIG. 25 is a back side elevational view thereof;
FIG. 26 is a top plan view thereof;
FIG. 27 is a bottom plan view thereof;
FIG. 28 is a side elevational view of the design of FIG. 21, the only difference being in the horizontal angle of the skirt;
FIG. 29 is a side elevational view of the design of FIG. 21, the only difference being in the near vertical angle of the skirt;
FIG. 30 is a side elevational view of the design of FIG. 21, the only difference being in the downward angle of the skirt;
FIG. 31 is a perspective view of a fourth embodiment of our new flower pot cover design;
FIG. 32 is a left side elevational view thereof;
FIG. 33 is a right side elevational view thereof;
FIG. 34 is a front side elevational view thereof;
FIG. 35 is a back side elevational view thereof;

FIG. 36 is a top plan view thereof;
FIG. 37 is a bottom plan view thereof;
FIG. 38 is a side elevational view of the design of FIG. 31, the only difference being in the horizontal angle of the skirt;
FIG. 39 is a side elevational view of the design of FIG. 31, the only difference being in the near vertical angle of the skirt;
FIG. 40 is a side elevational view of the design of FIG. 31, the only difference being in the downward angle of the skirt;
FIG. 41 is a perspective view of a fifth embodiment of our new flower pot cover design;
FIG. 42 is a left side elevational view thereof;
FIG. 43 is a right side elevational view thereof;
FIG. 44 is a front side elevational view thereof;
FIG. 45 is a back side elevational view thereof;
FIG. 46 is a top plan view thereof;
FIG. 47 is a bottom plan view thereof;
FIG. 48 is a side elevational view of the design of FIG. 41, the only difference being in the horizontal angle of the skirt;
FIG. 49 is a side elevational view of the design of FIG. 41, the only difference being in the near vertical angle of the skirt; and,
FIG. 50 is a side elevational view of the design of FIG. 41, the only difference being in the downward angle of the skirt. The characteristic feature of the design resides in the specific pleating arrangement, comprised of the parallel disposition of the exterior folds, in combination with the interior V-shaped folds, all as best seen in FIGS. 1, 11, 21, 31 and 41.

1 Claim, 10 Drawing Sheets

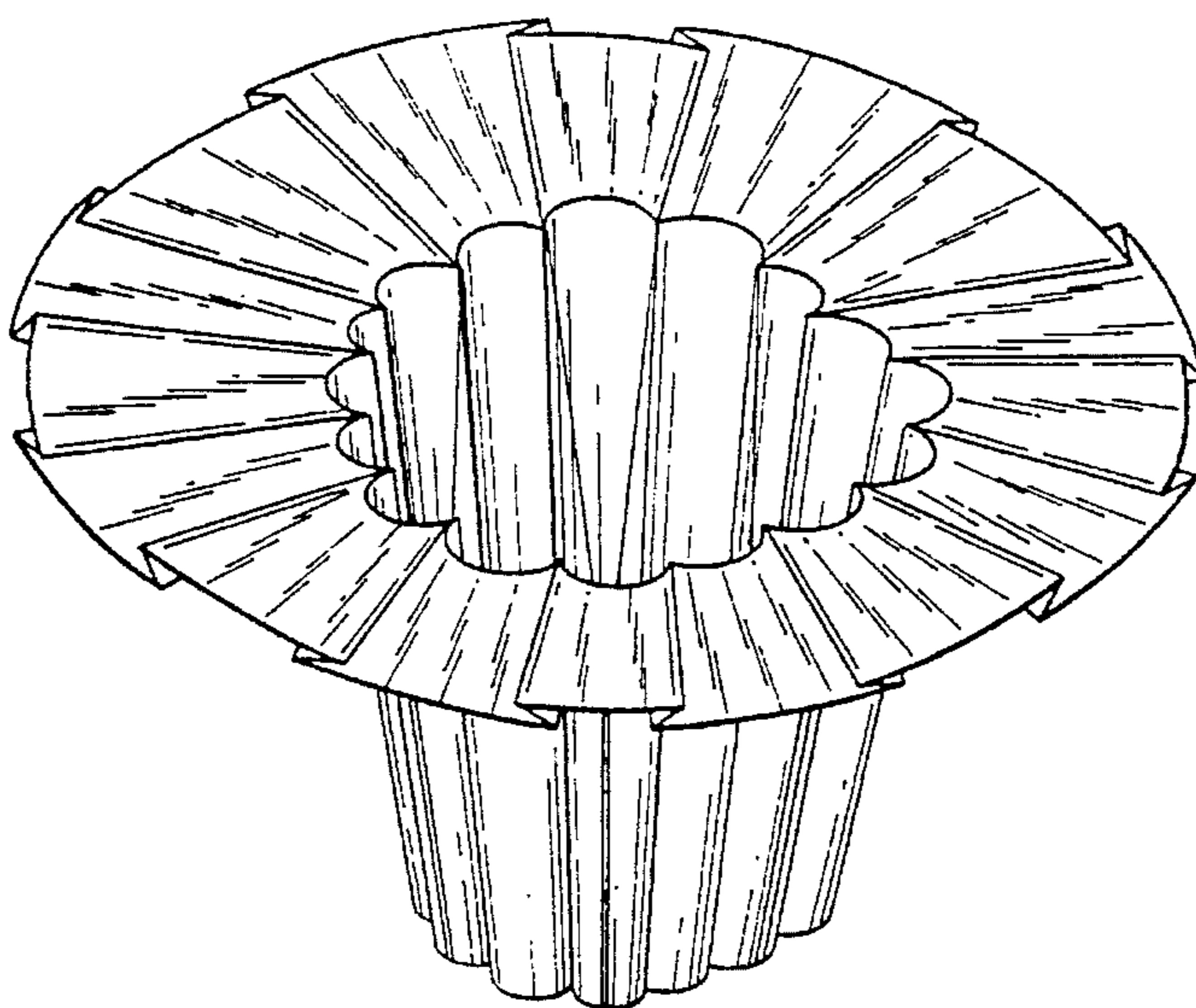

FIG. 1

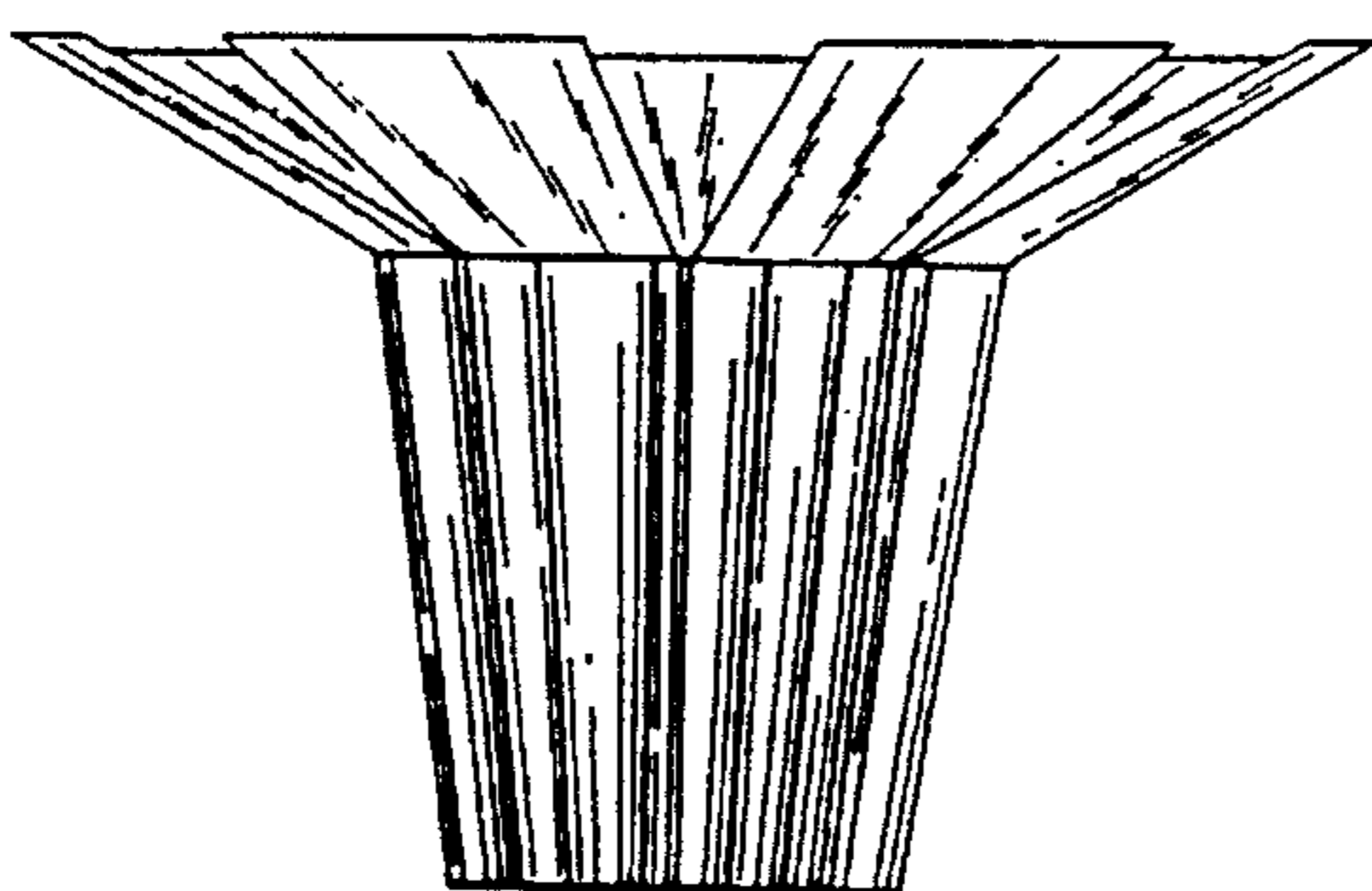

FIG. 2

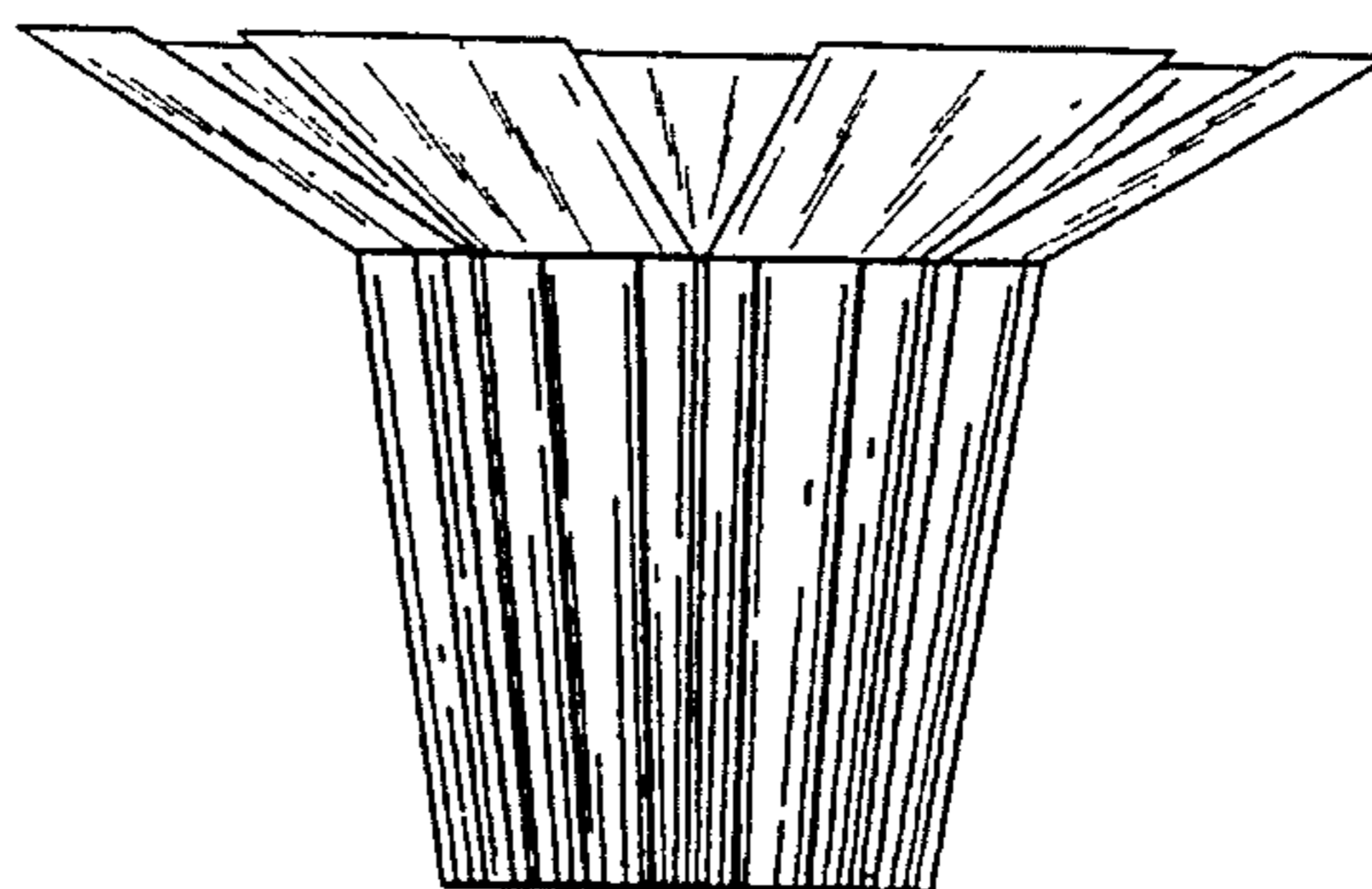

FIG. 3

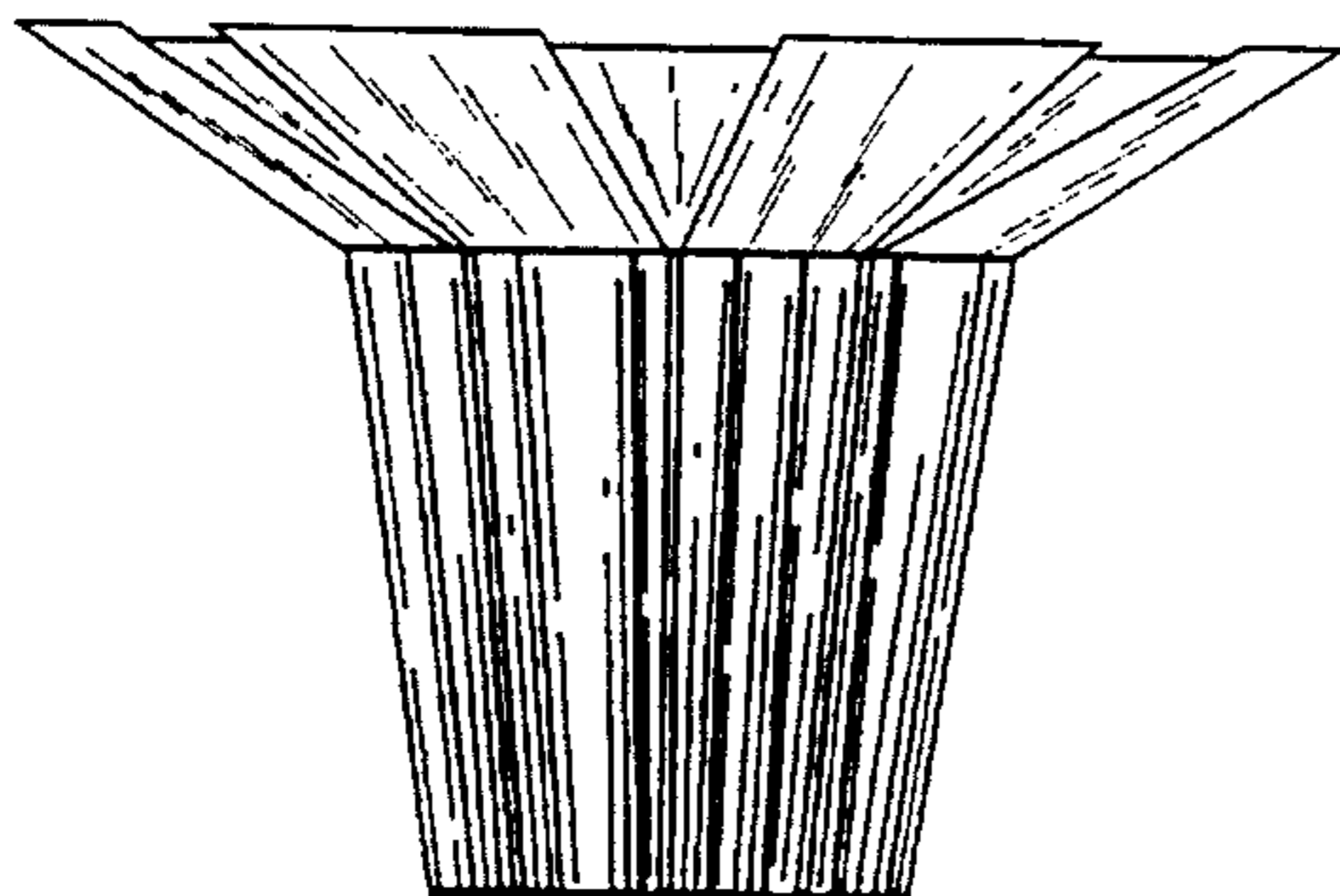

FIG. 4

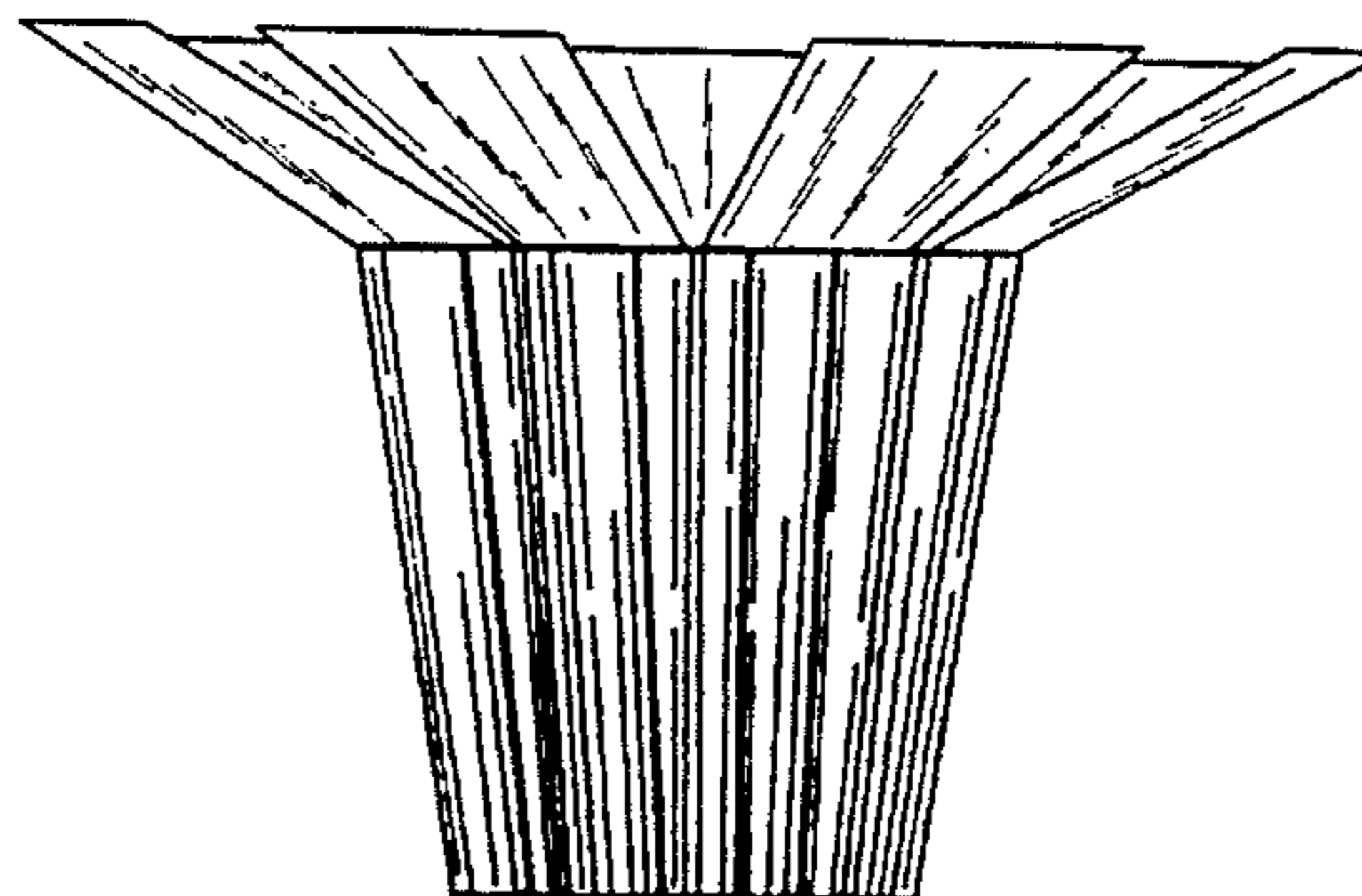
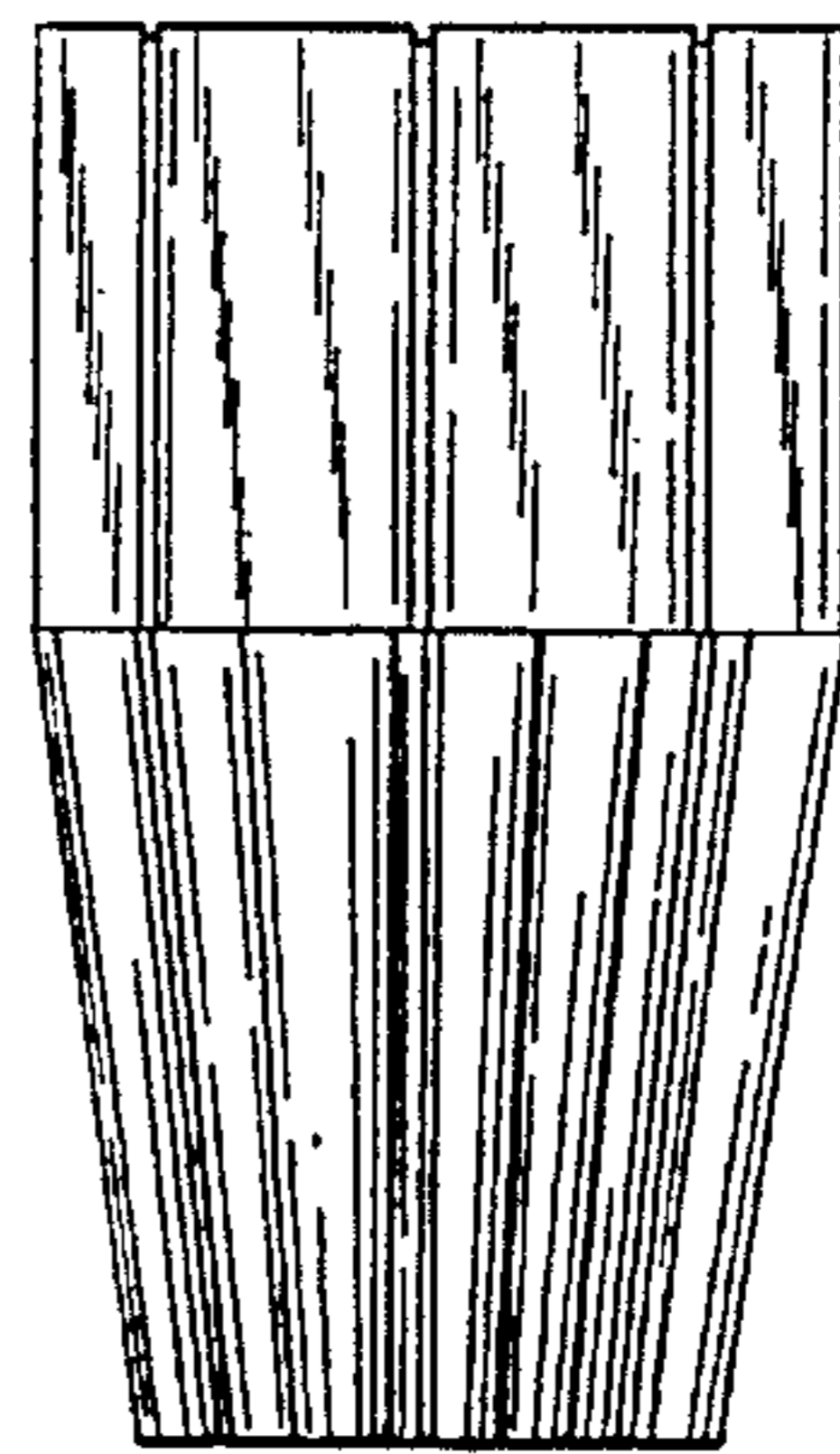
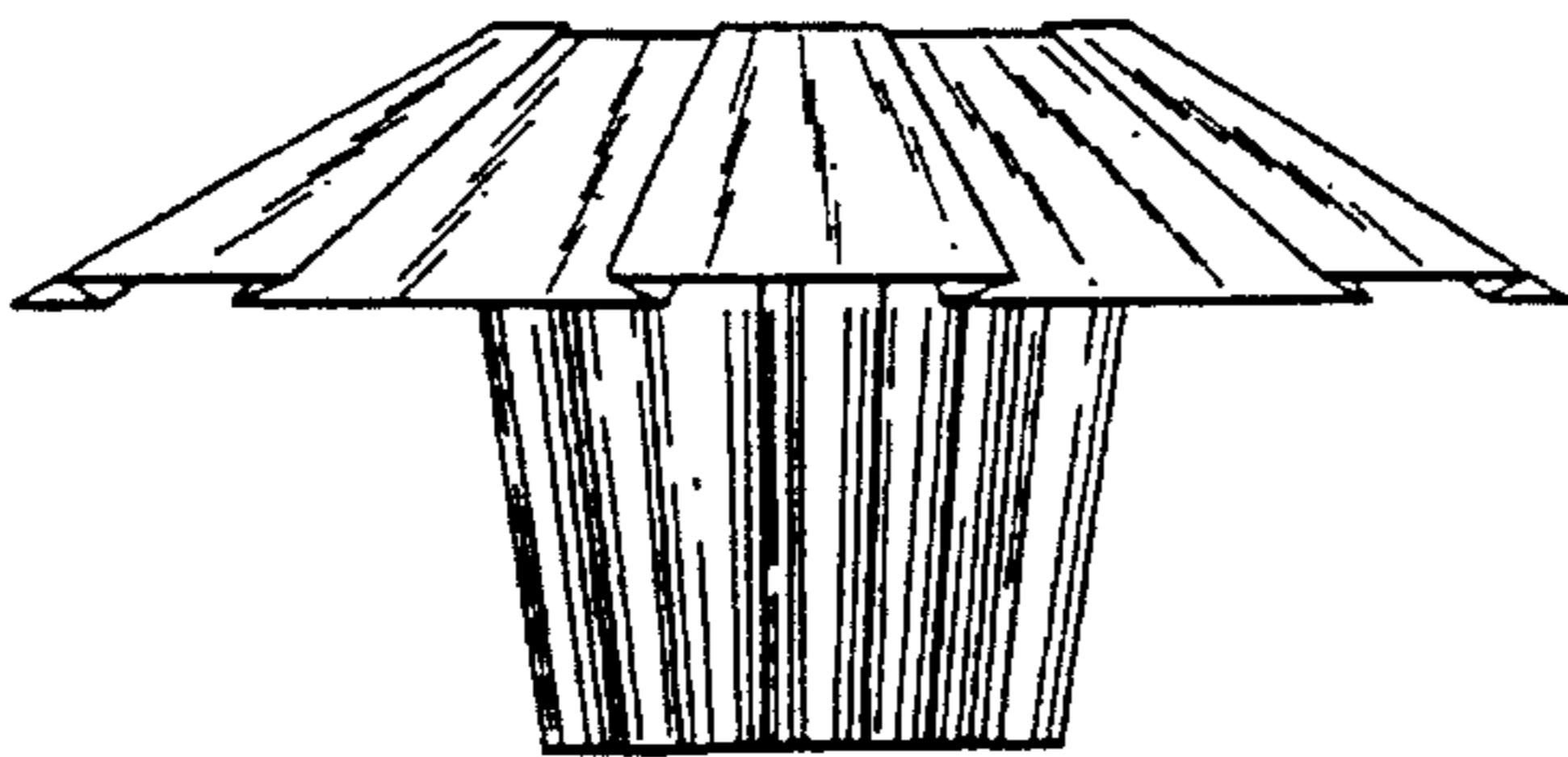
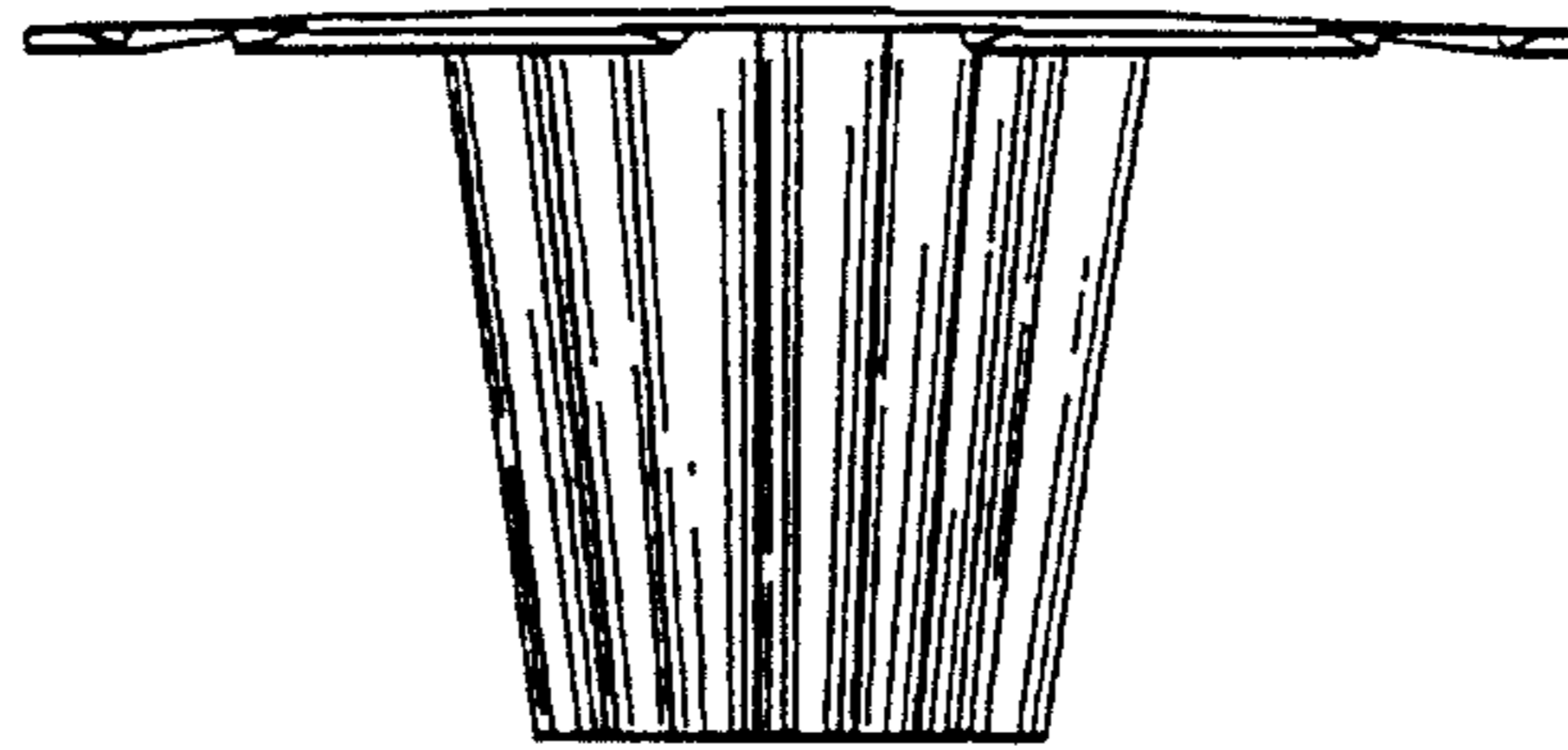
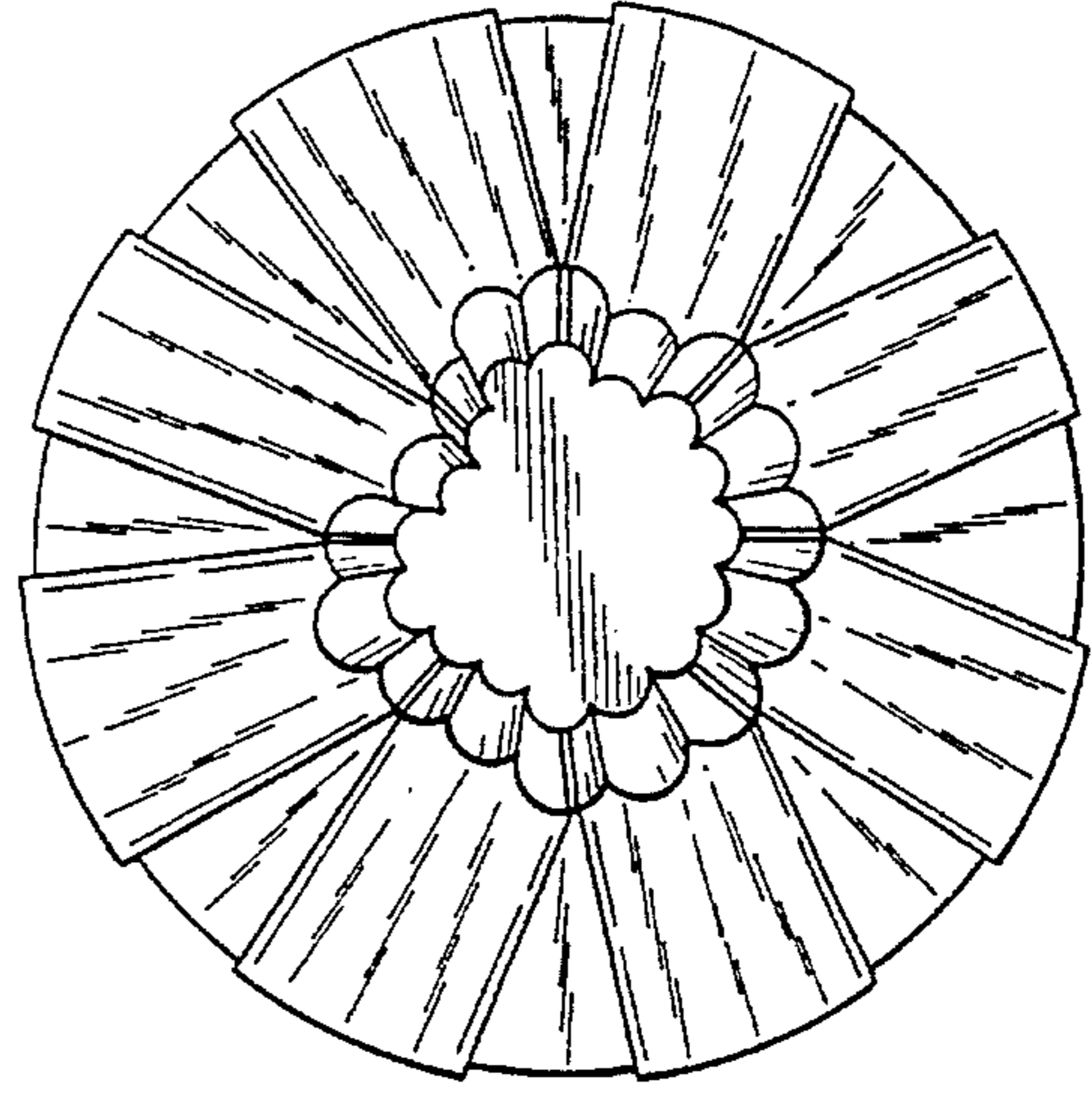
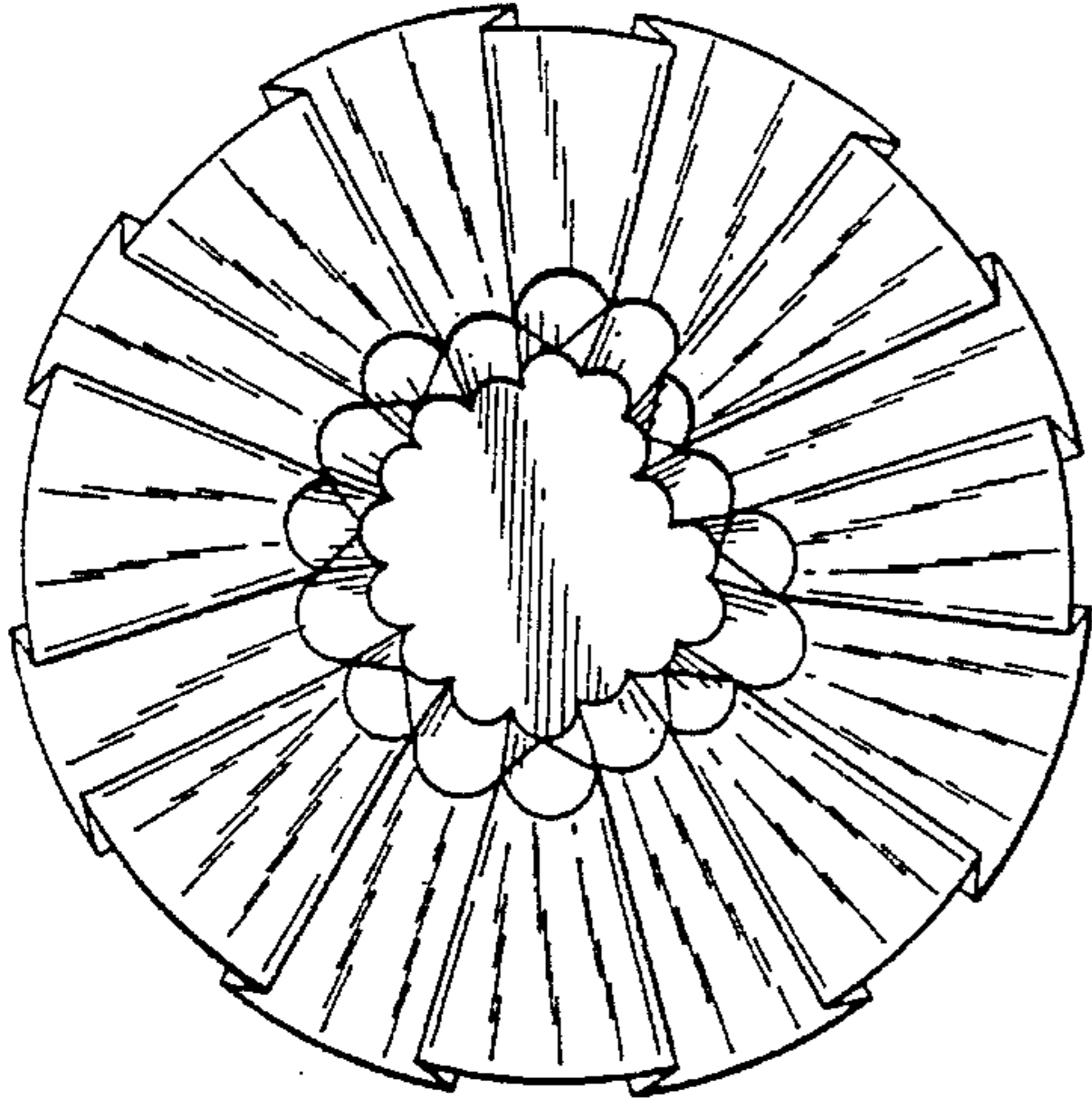

FIG. 5



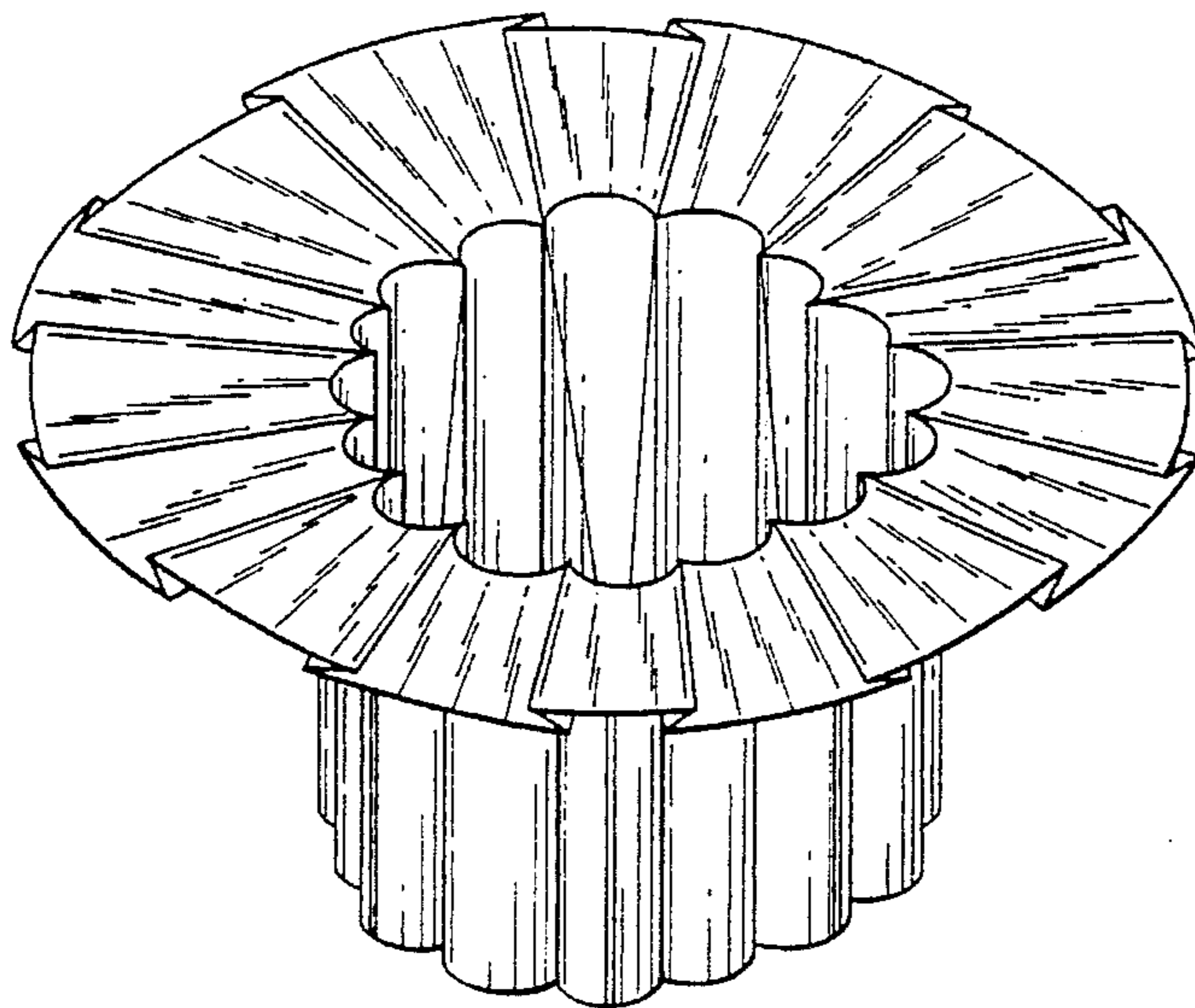

FIG. 11

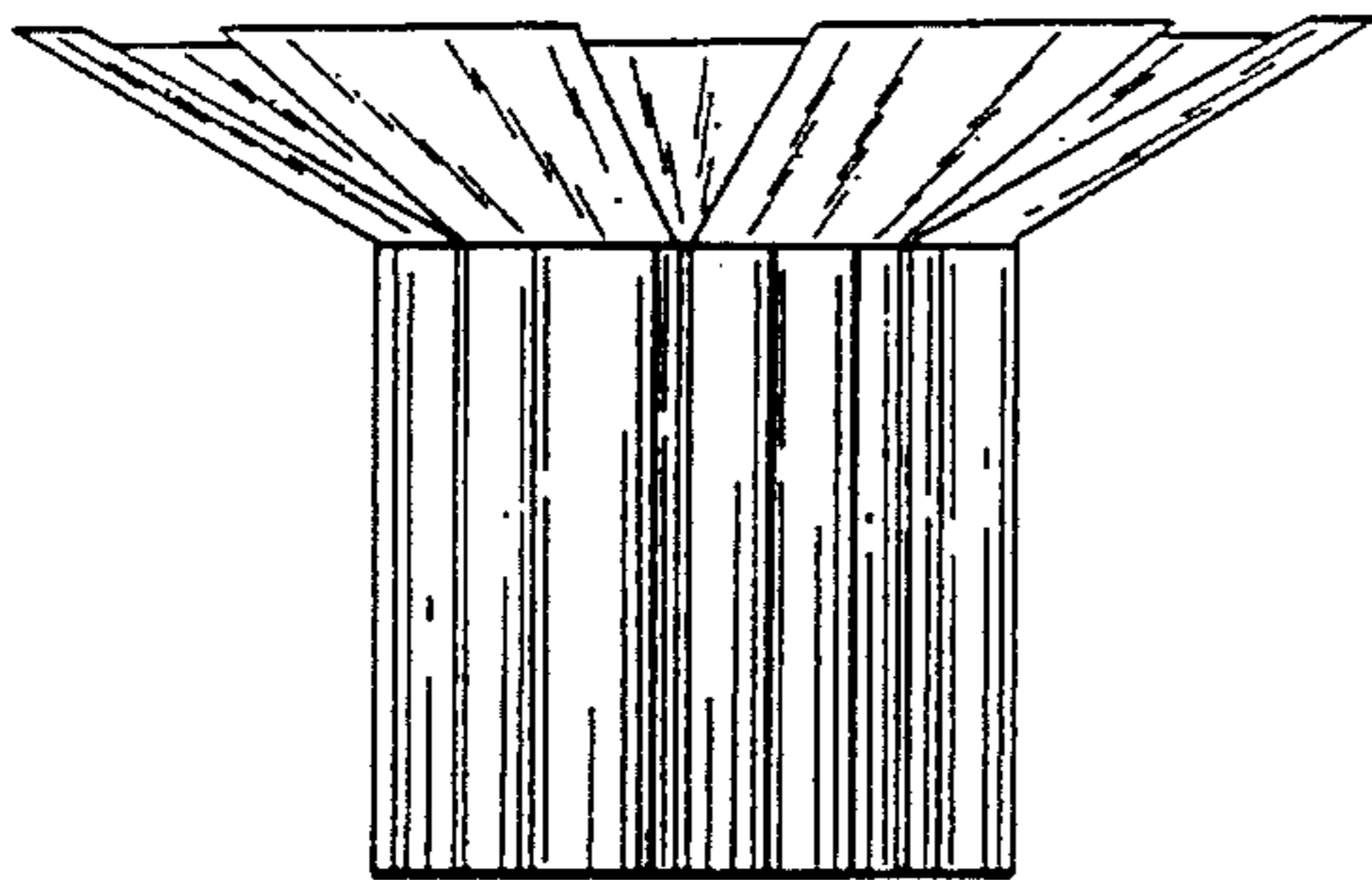

FIG. 12

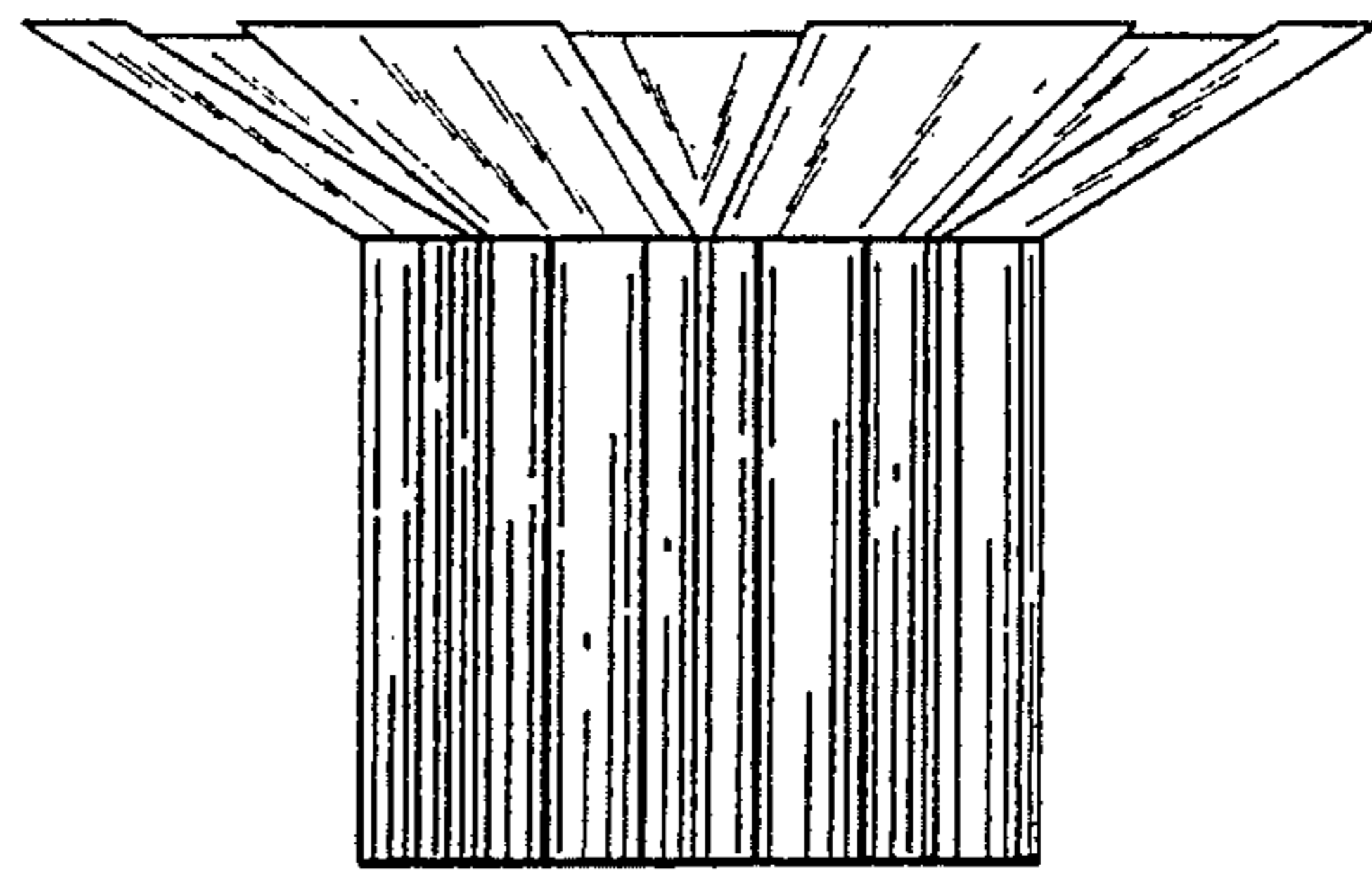

FIG. 13

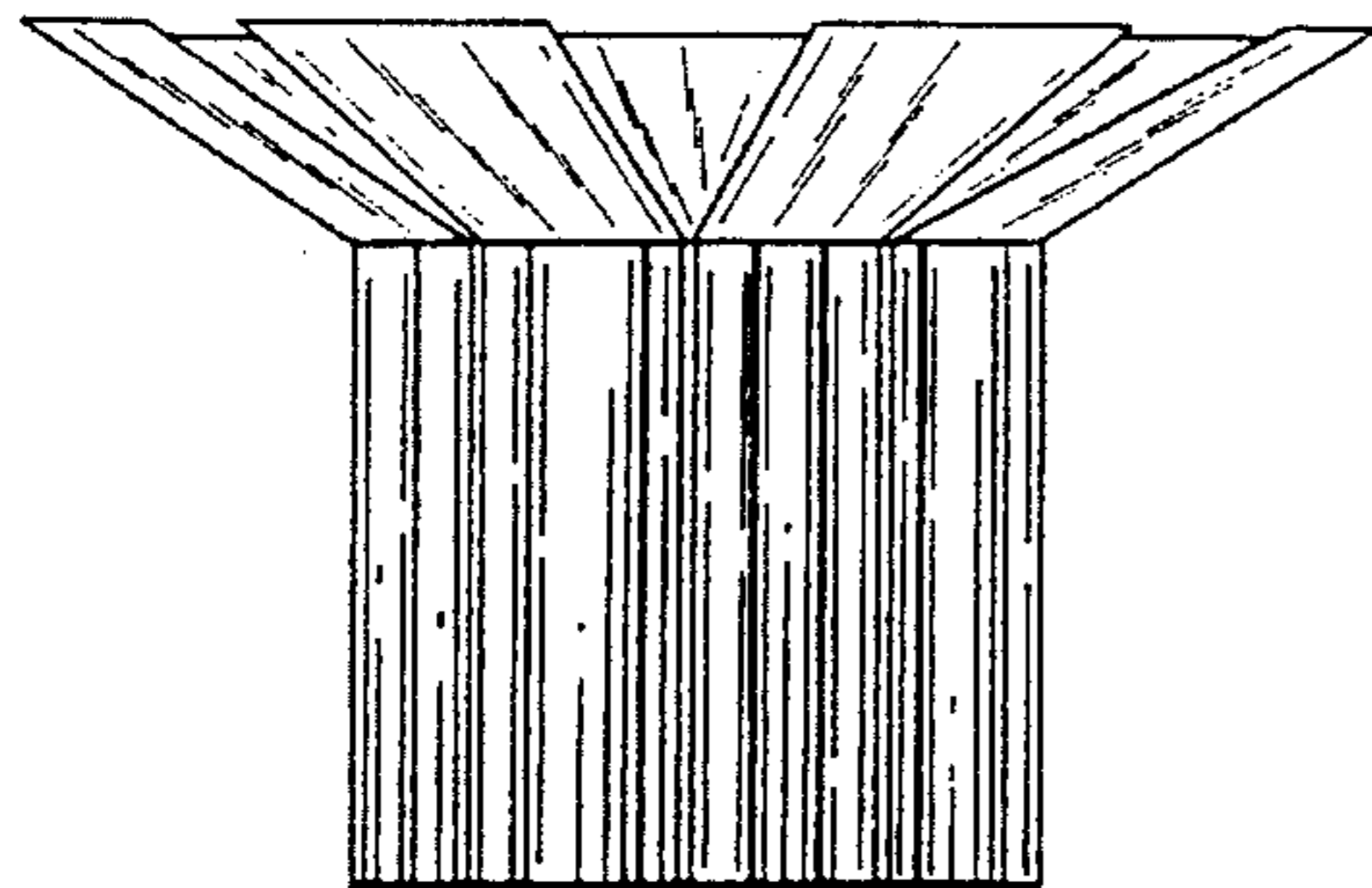

FIG. 14

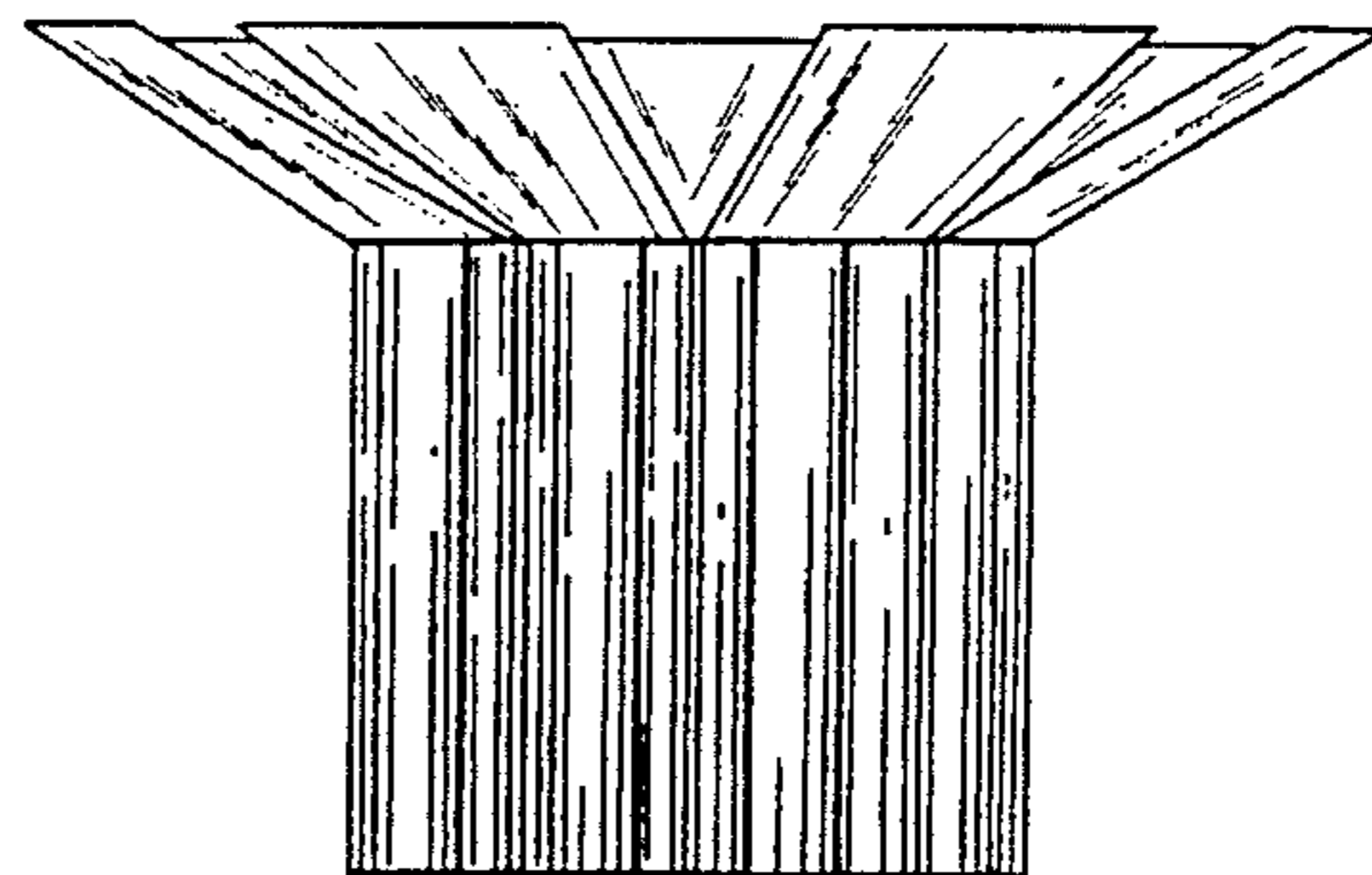

FIG. 15

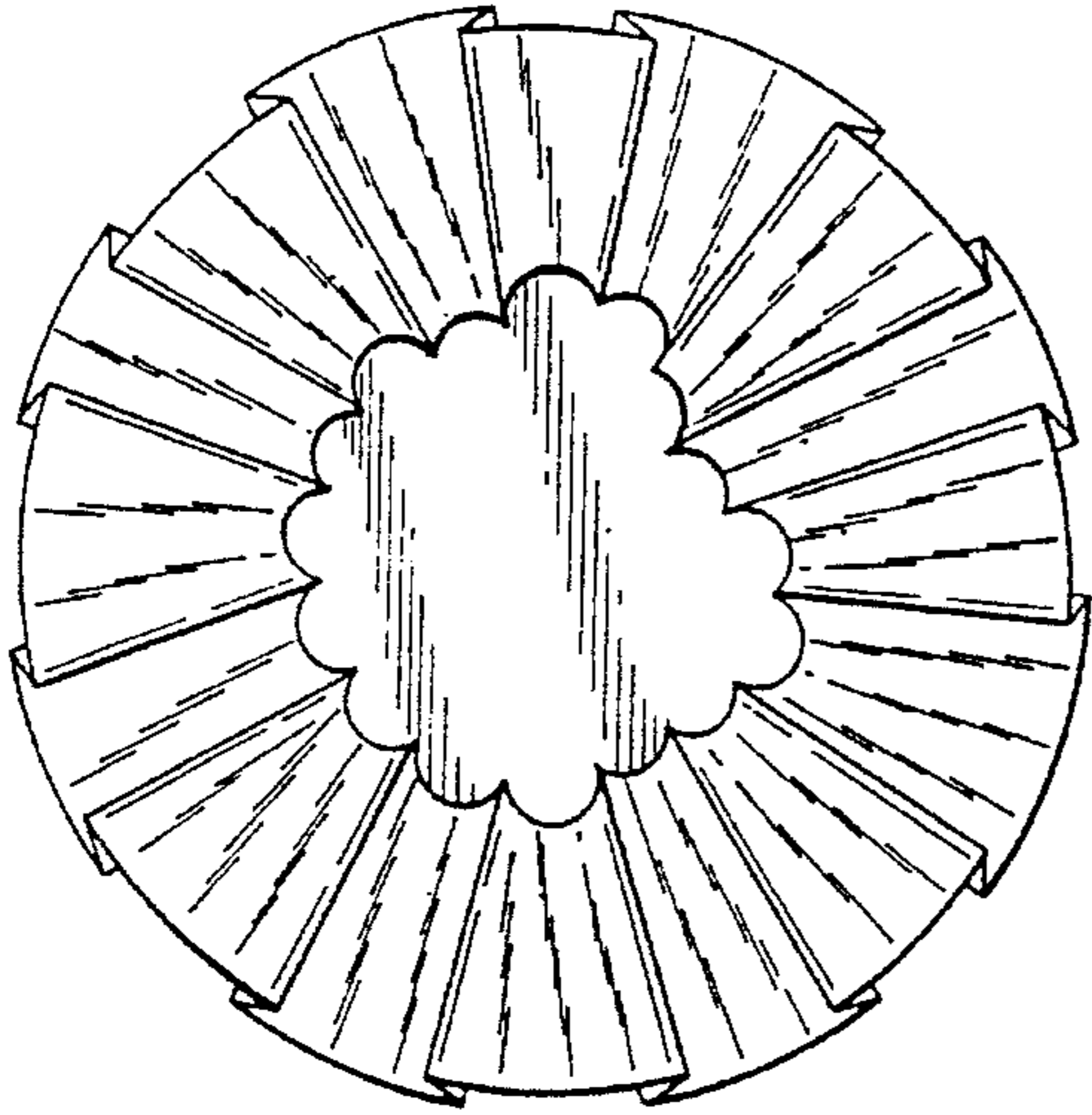

FIG. 16

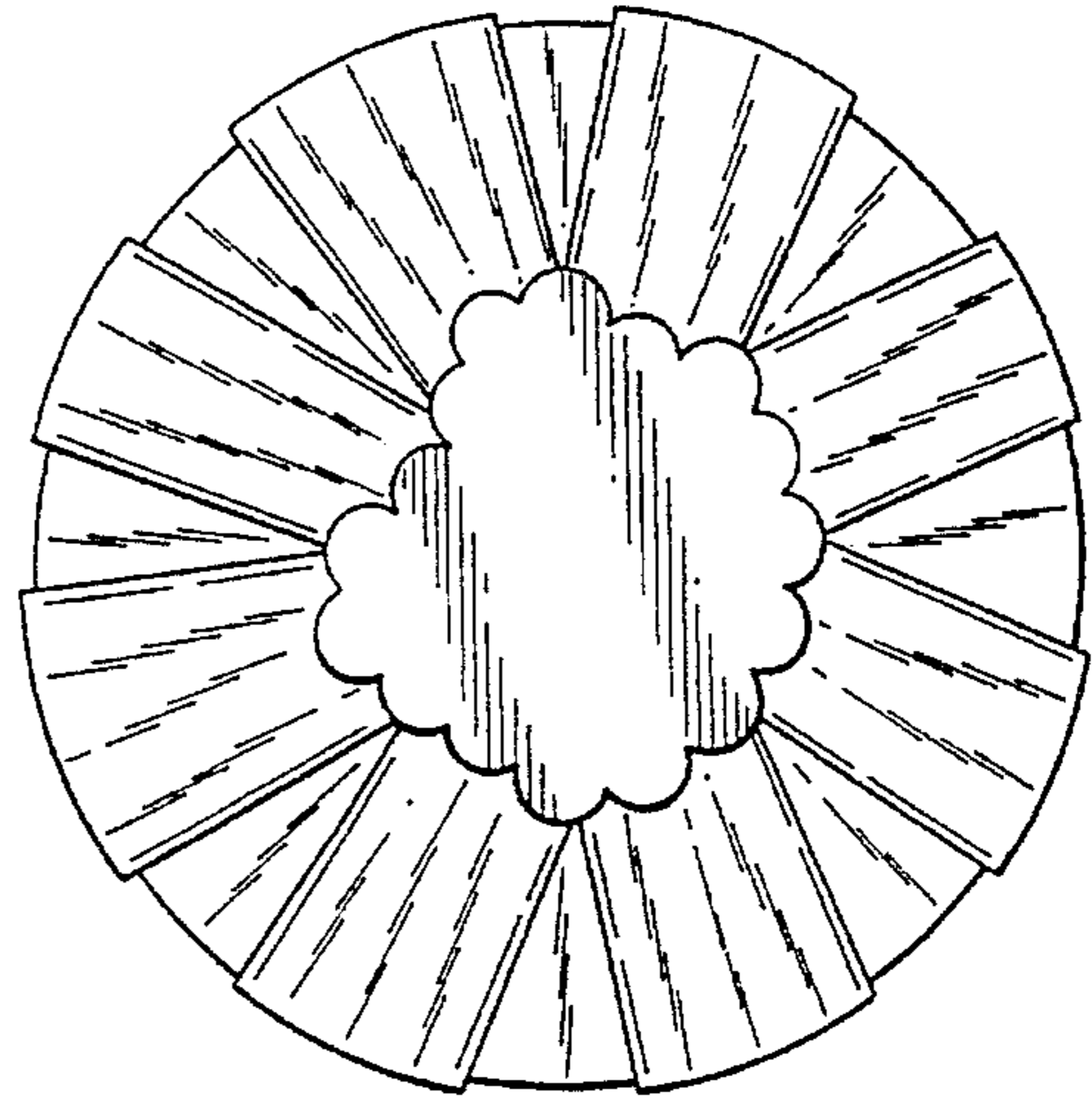

FIG. 17

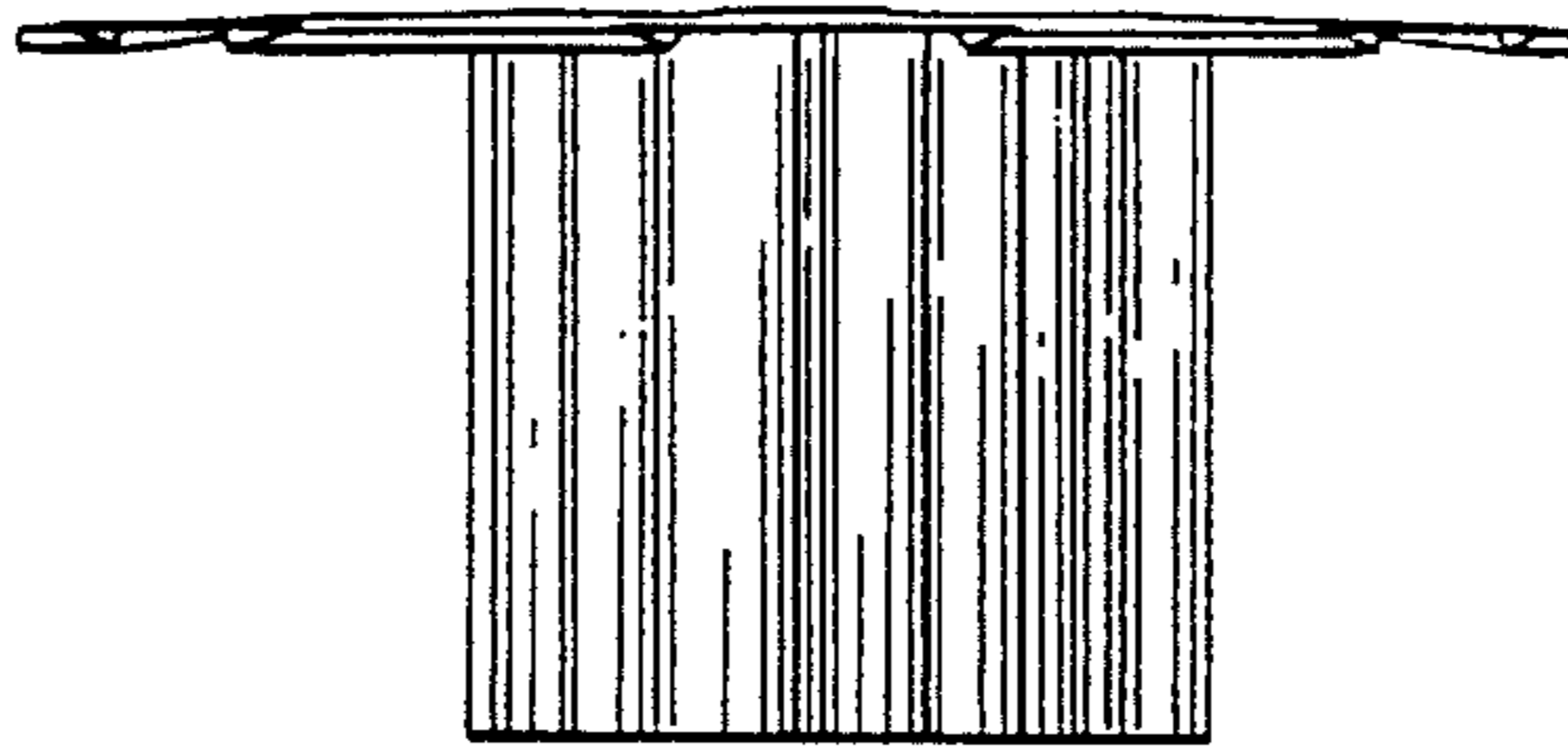

FIG. 18

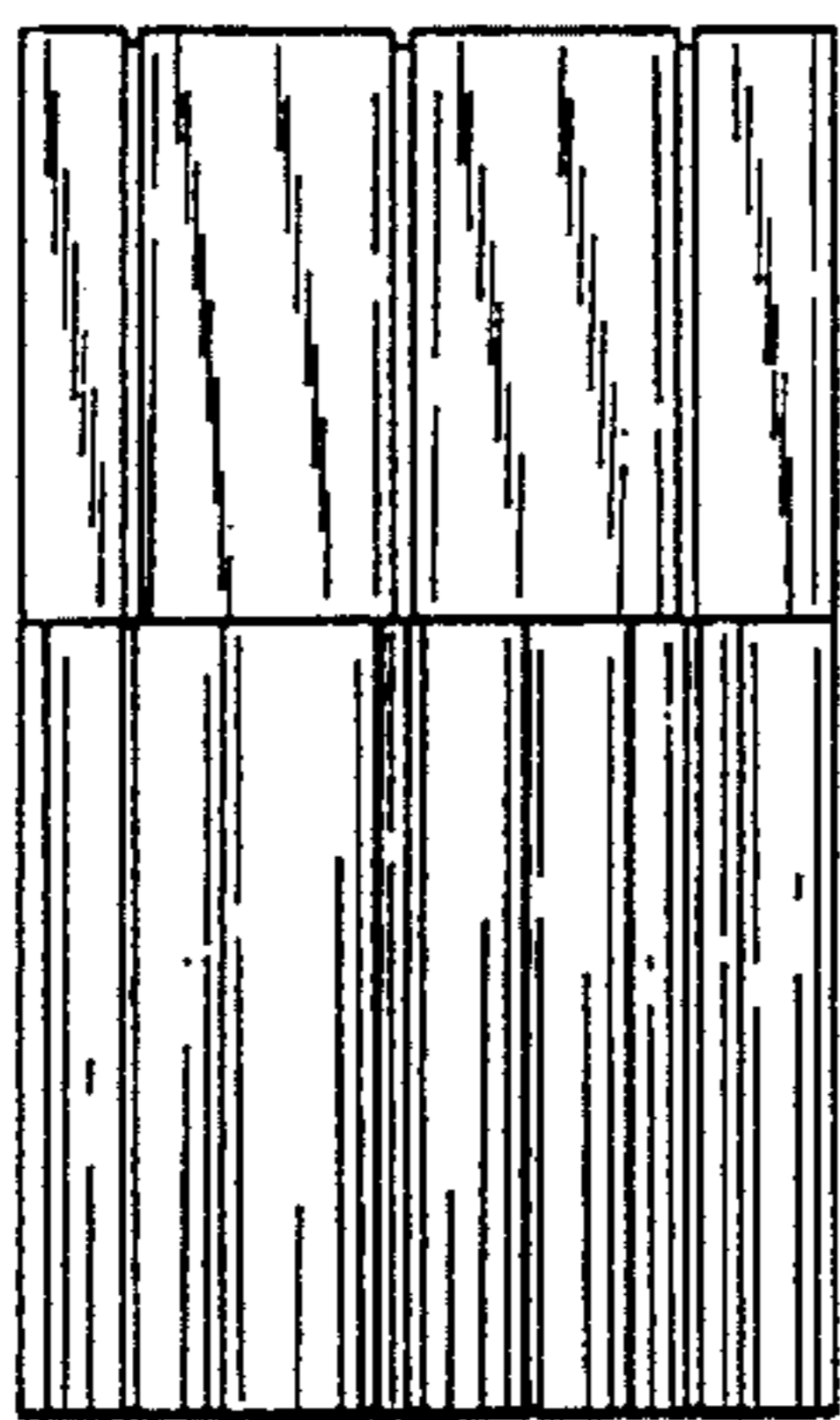

FIG. 19

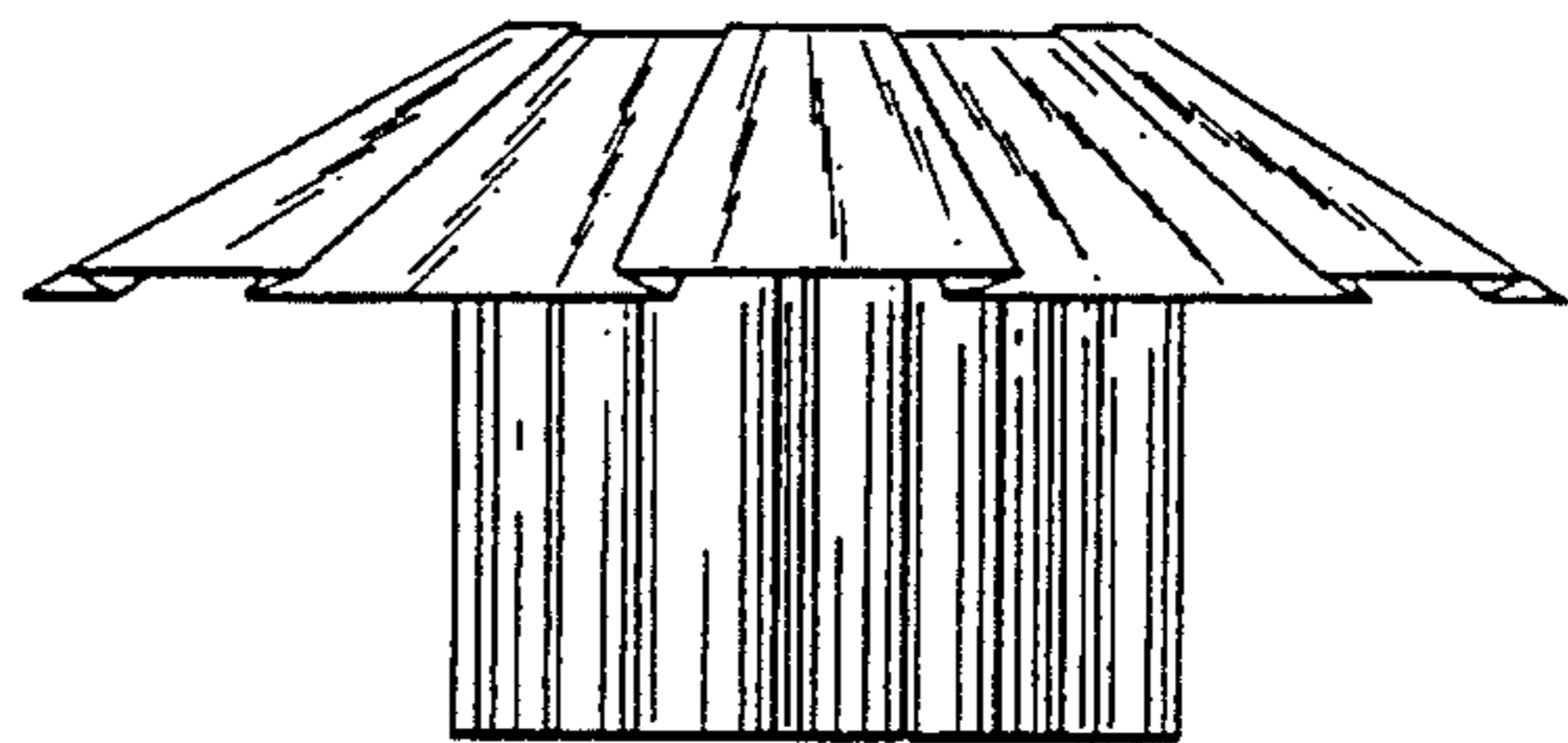

FIG. 20

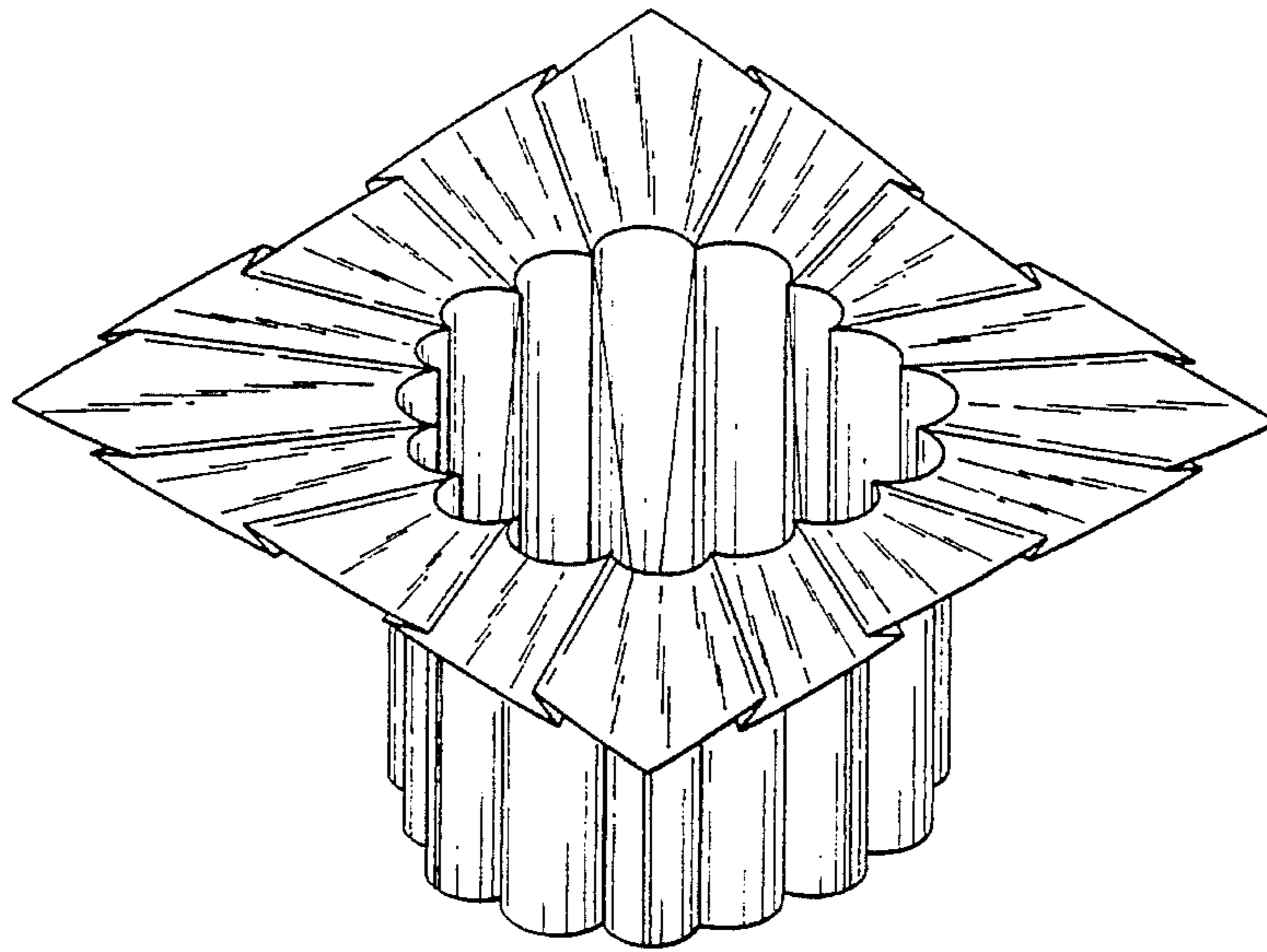

FIG. 21

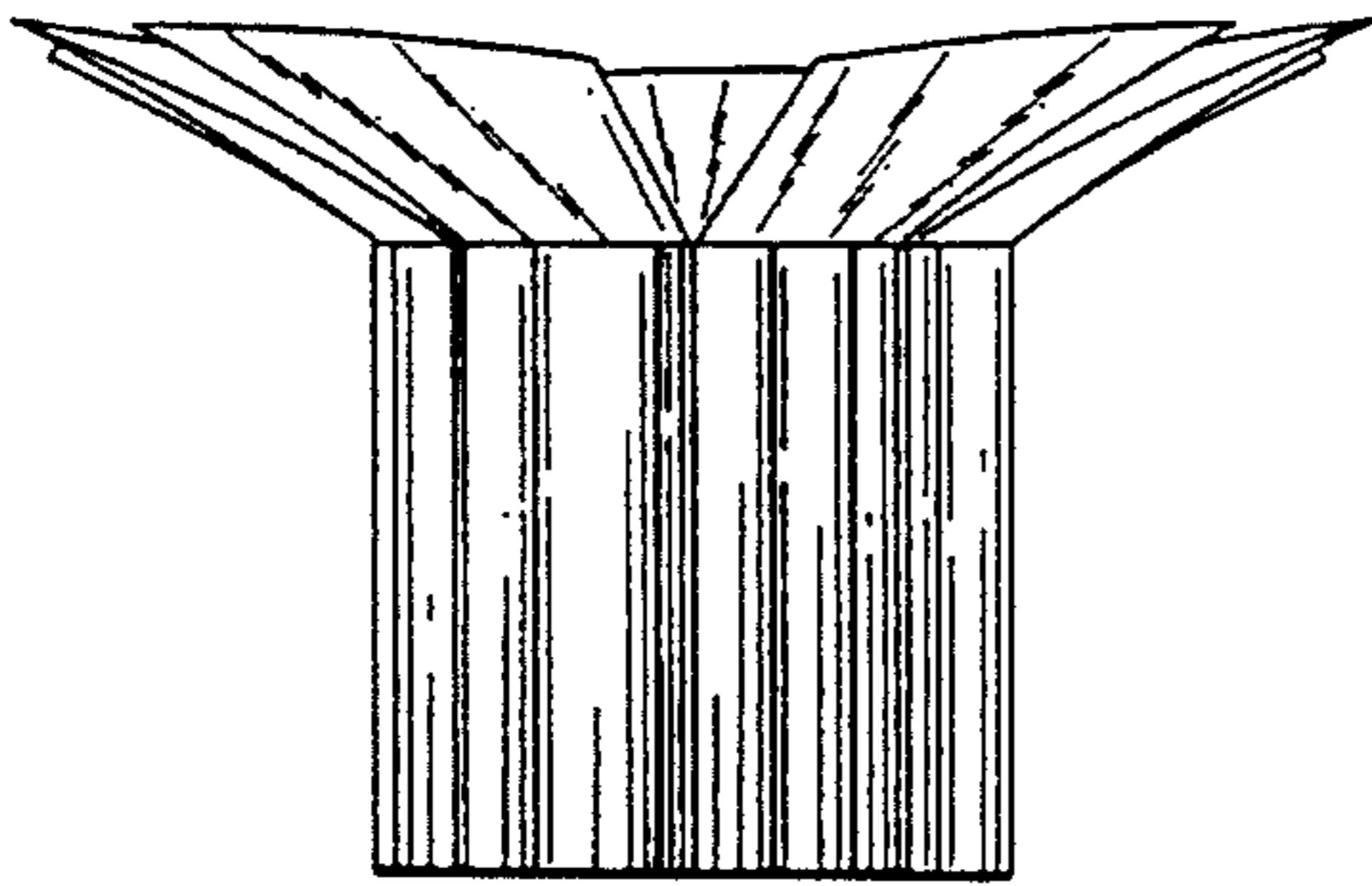

FIG. 22

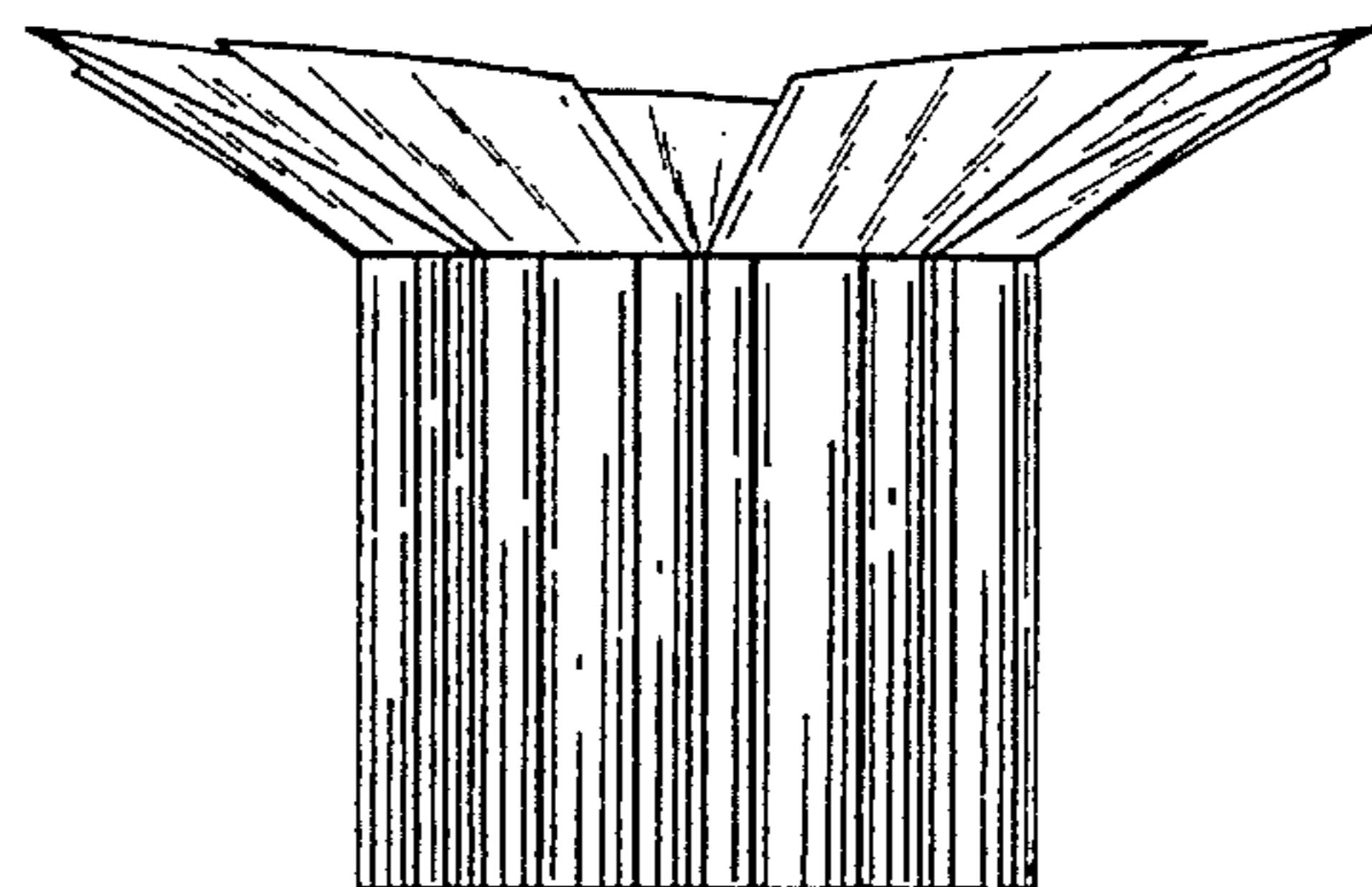

FIG. 23

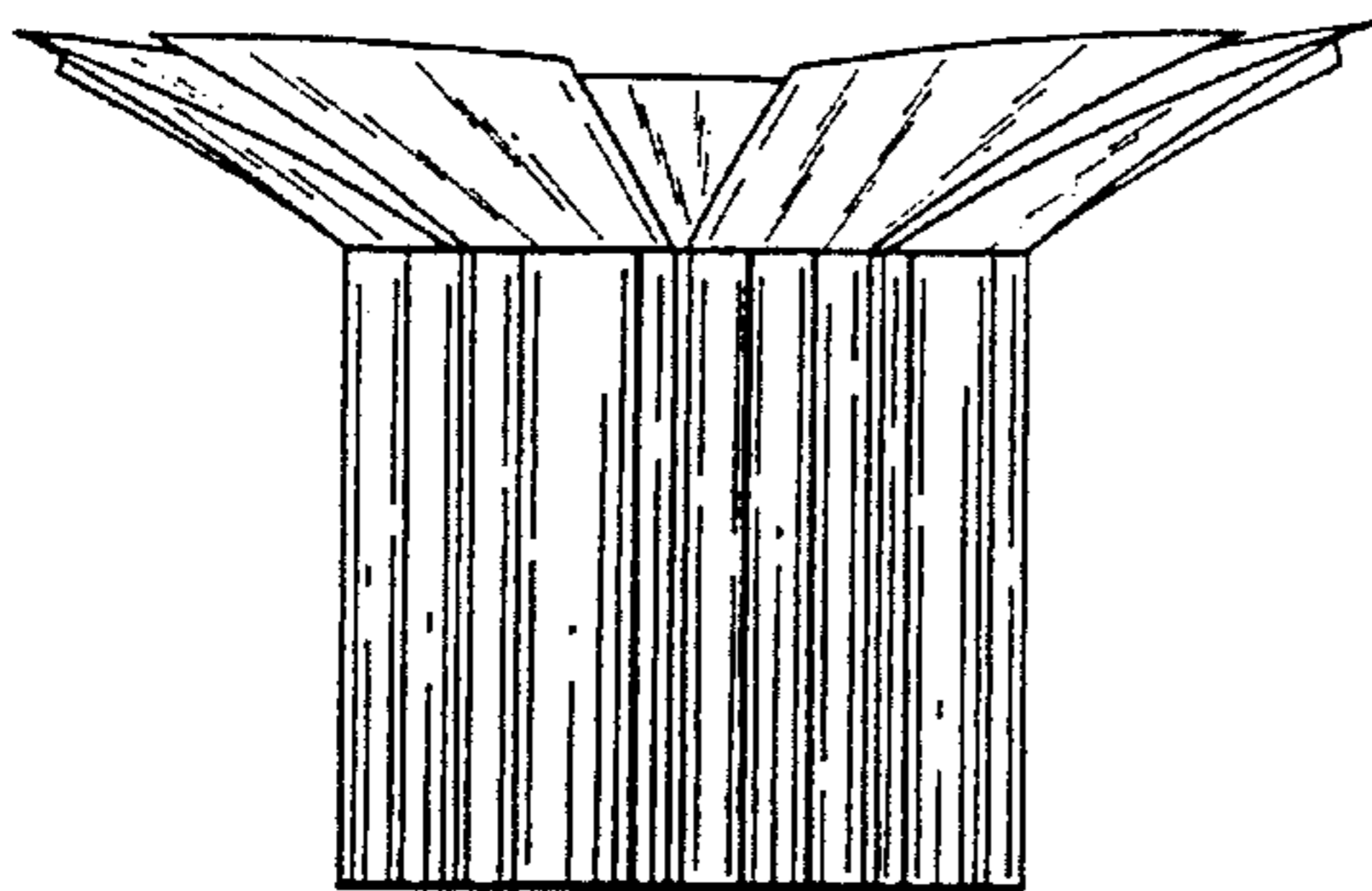

FIG. 24

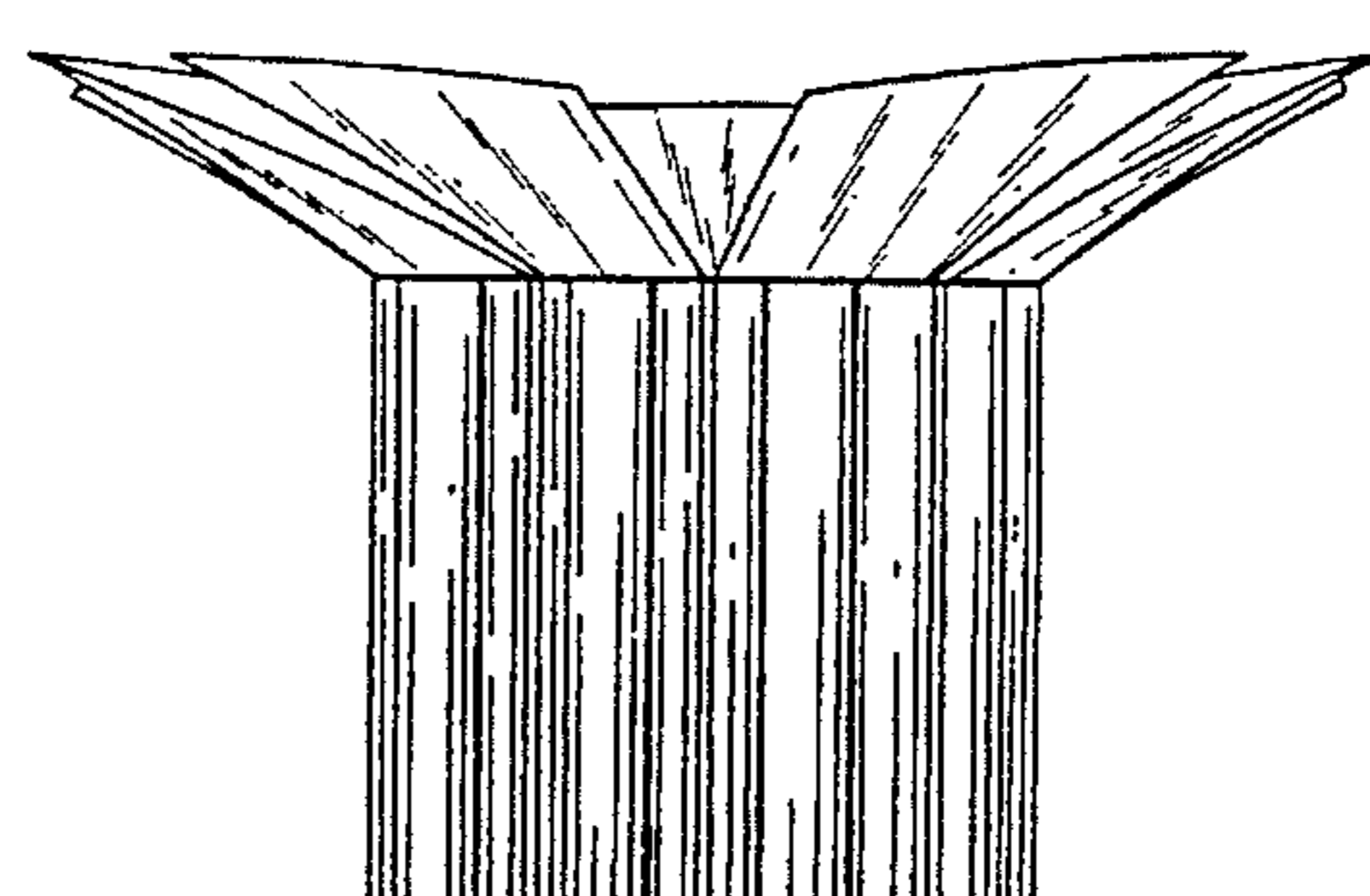

FIG. 25

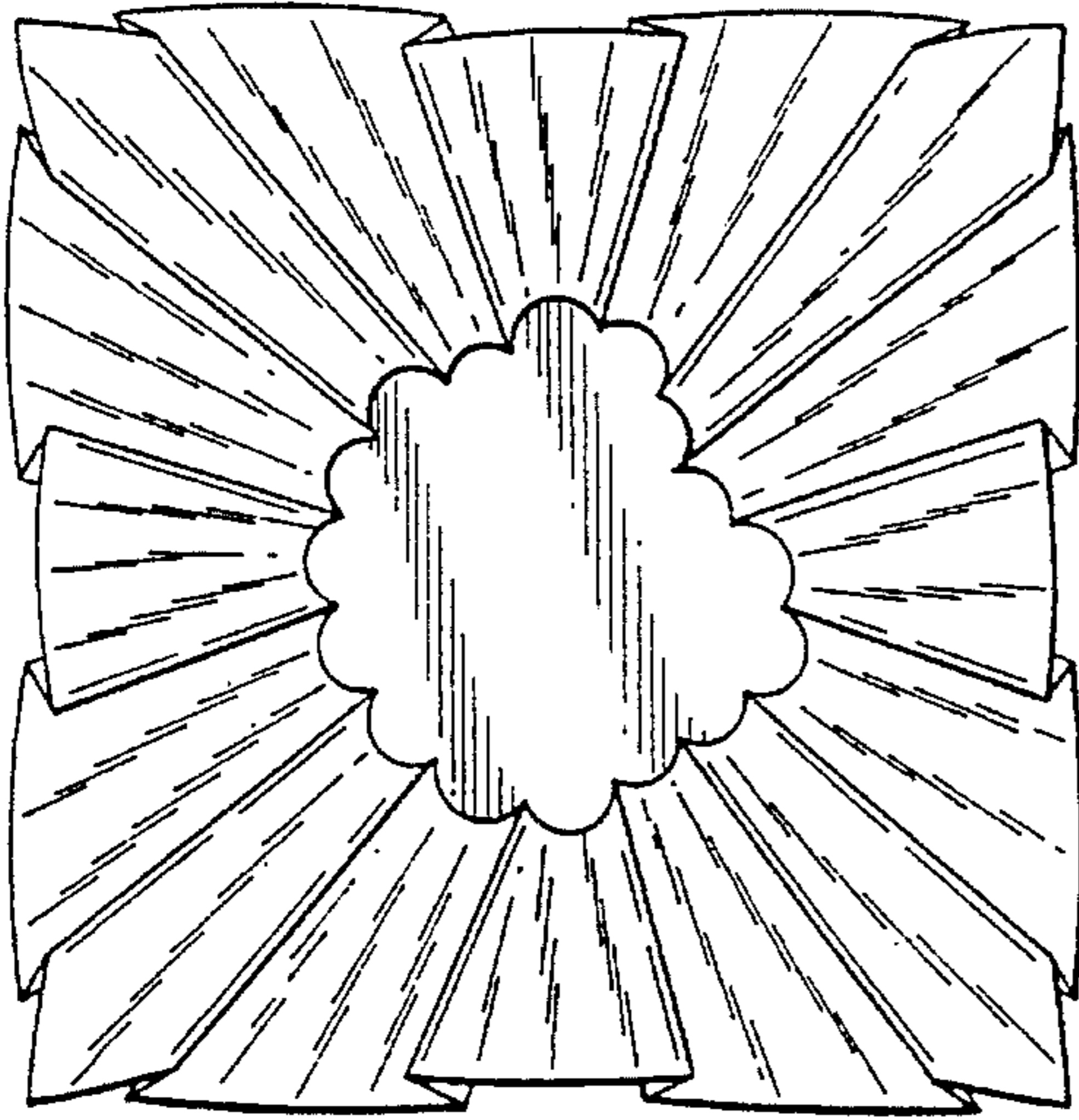

FIG. 26

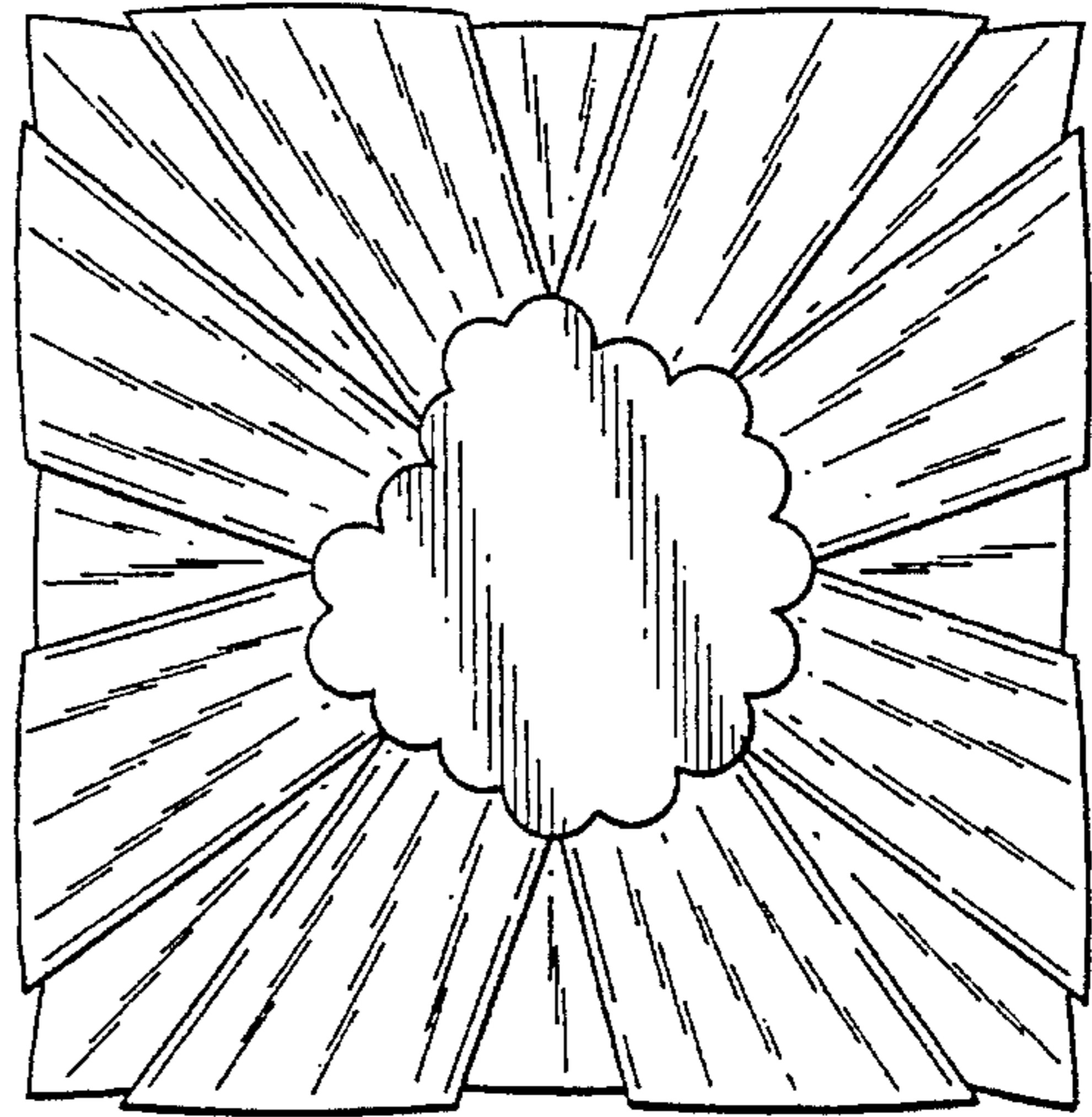

FIG. 27

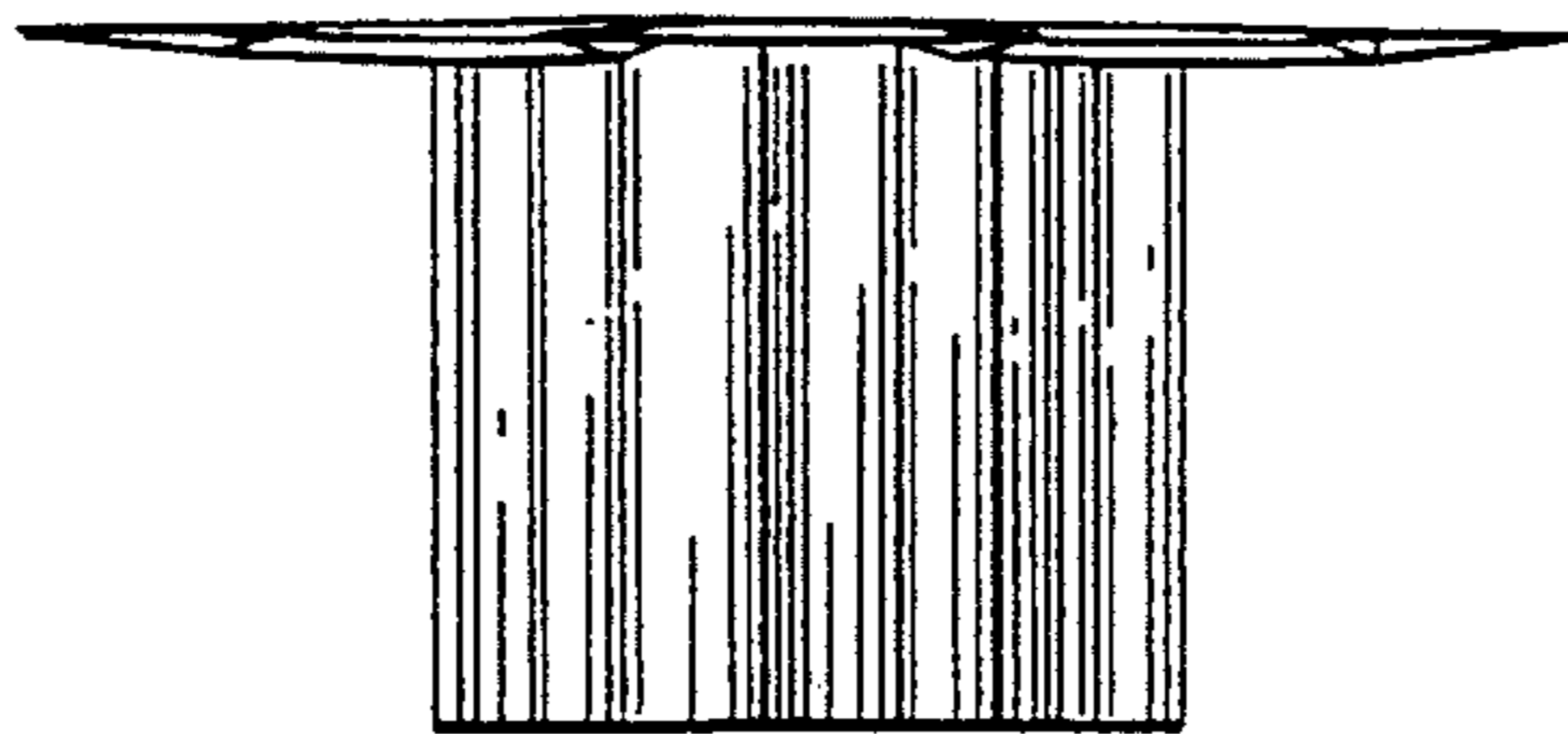

FIG. 28

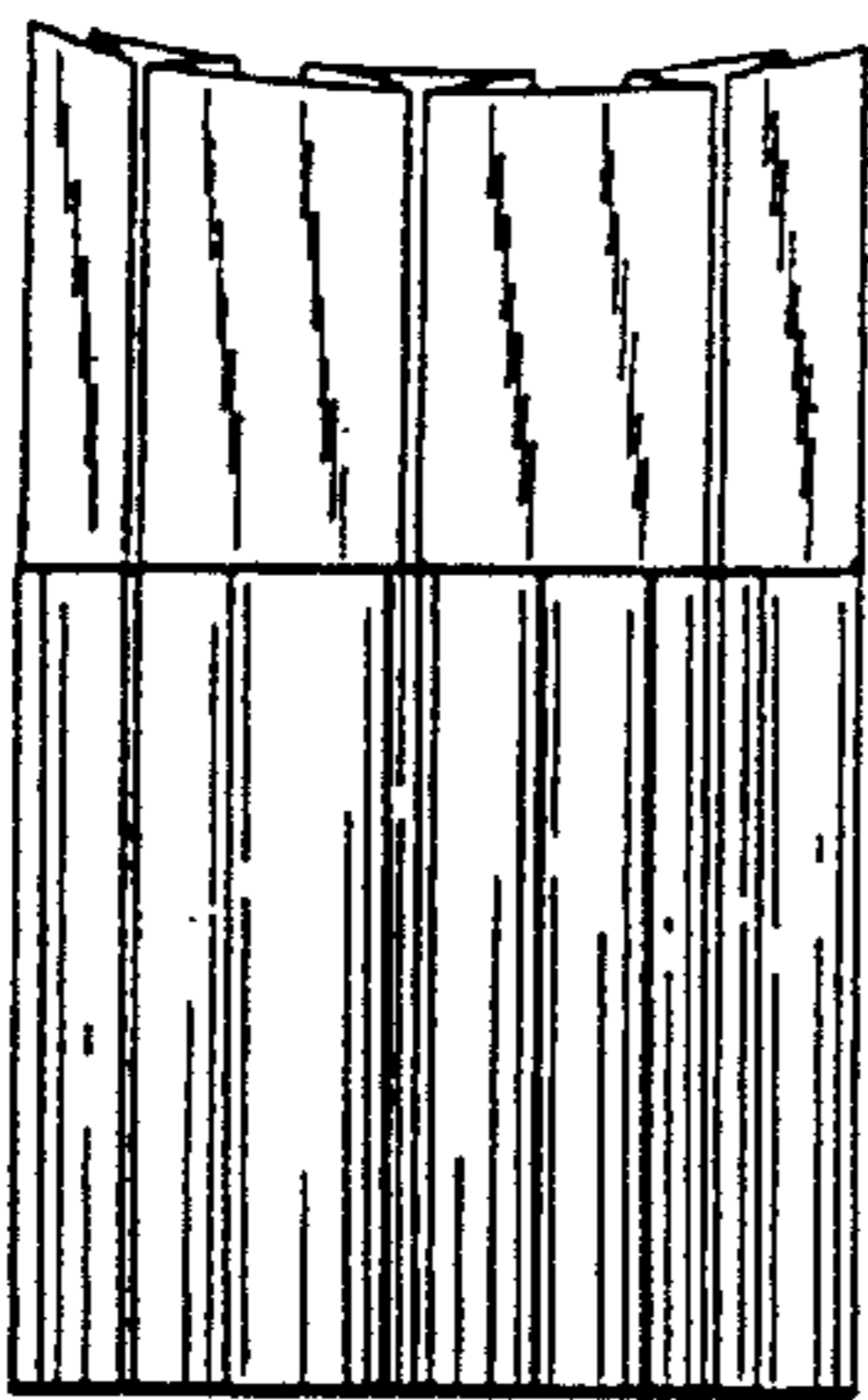

FIG. 29

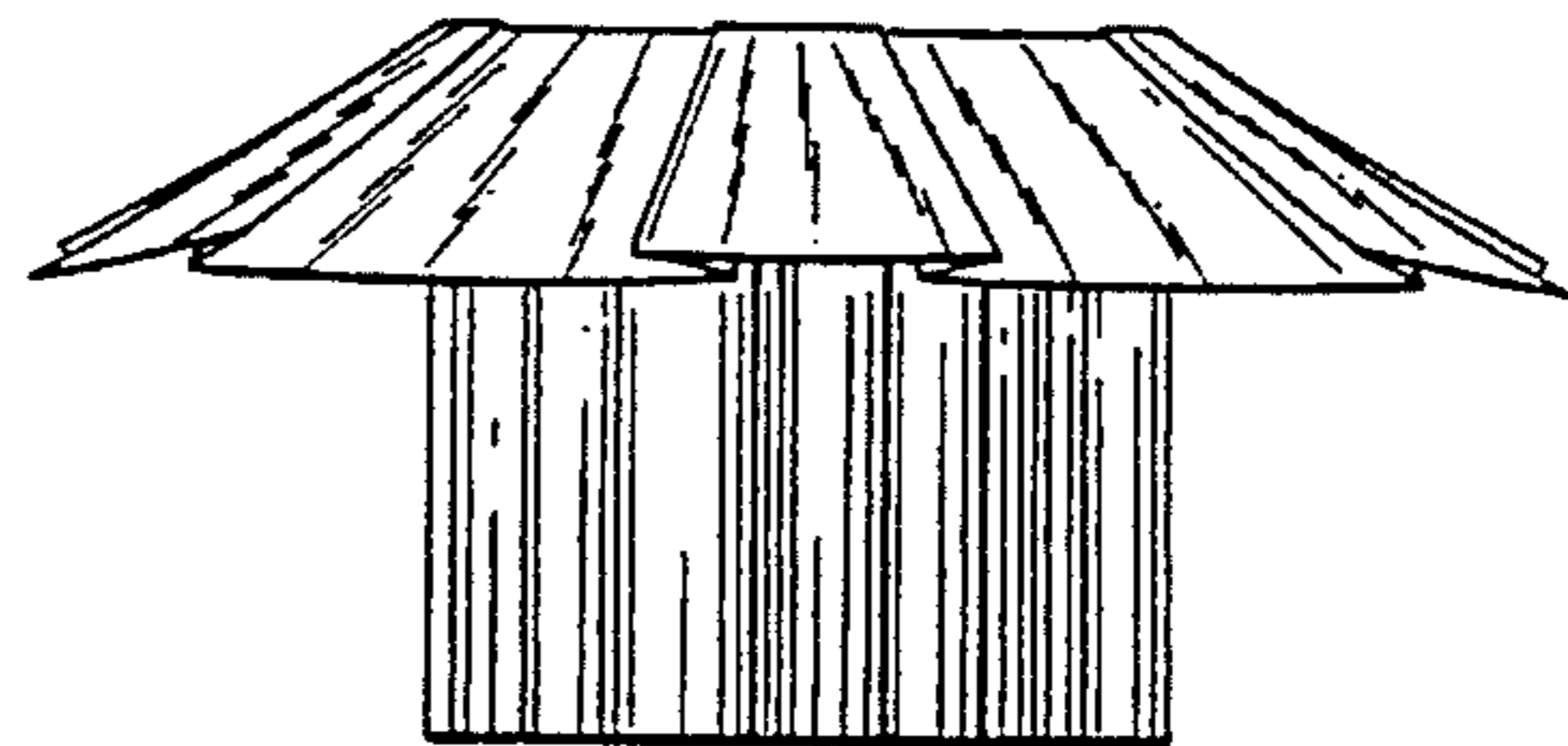

FIG. 30

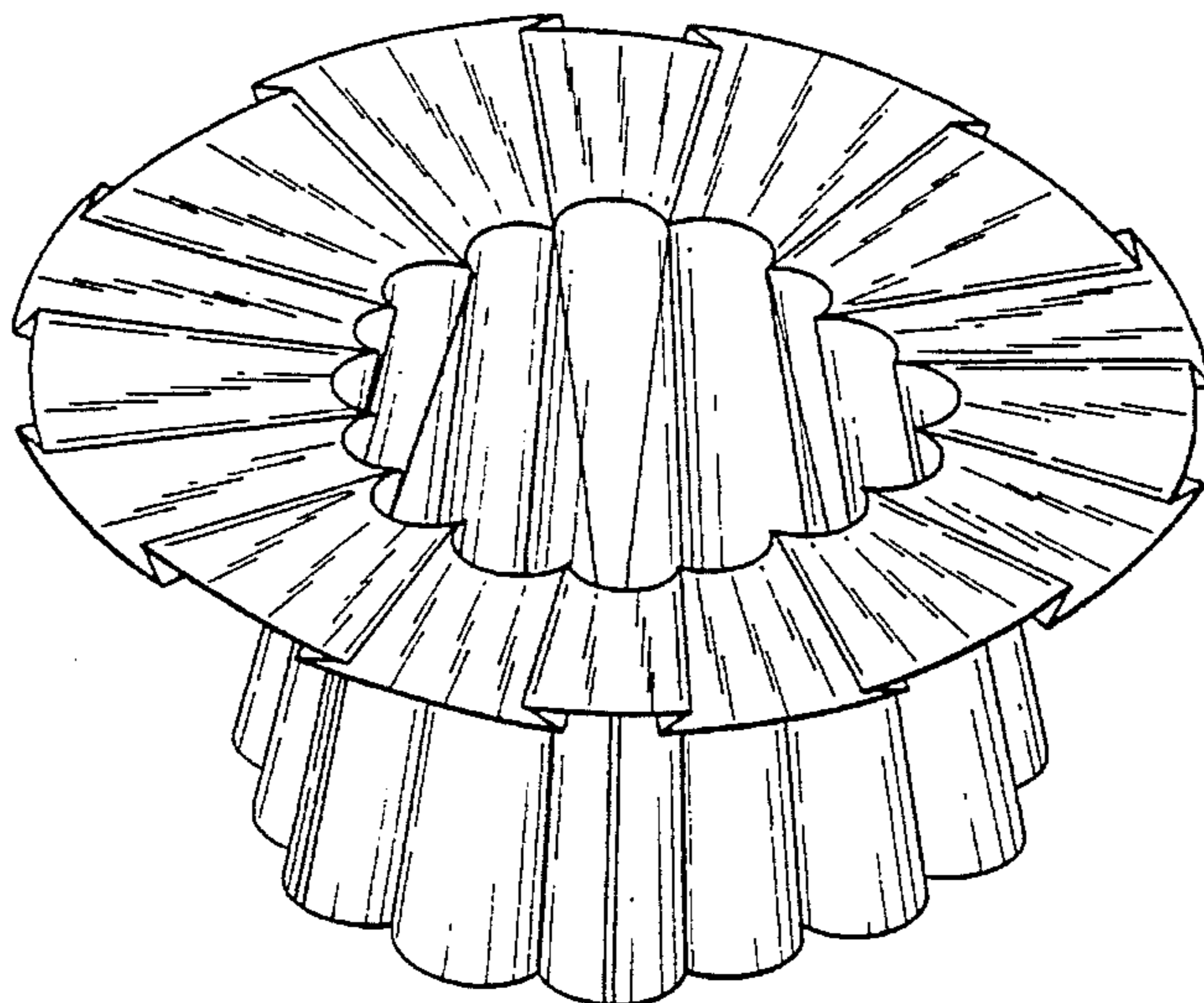

FIG. 31

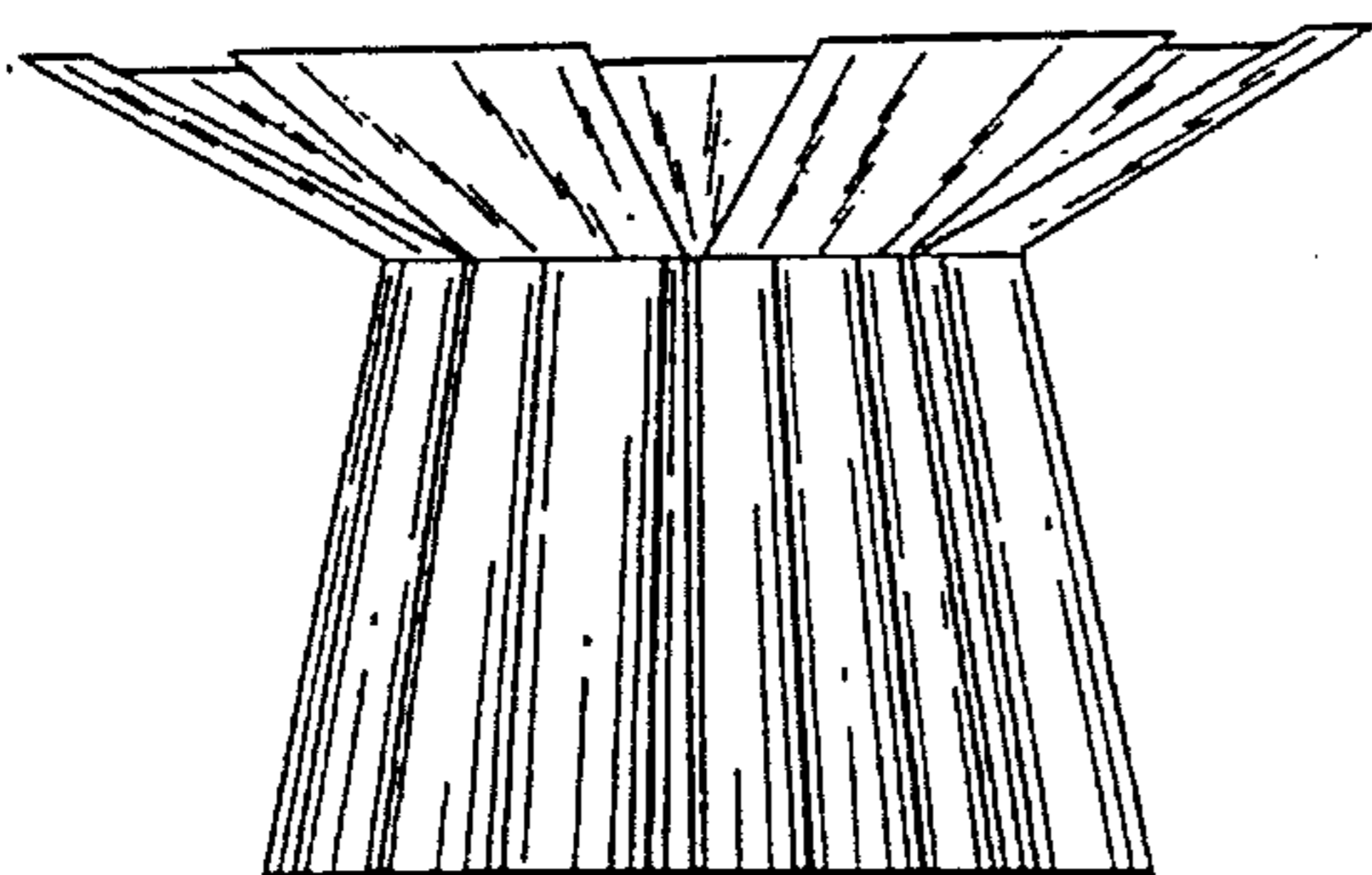

FIG. 32

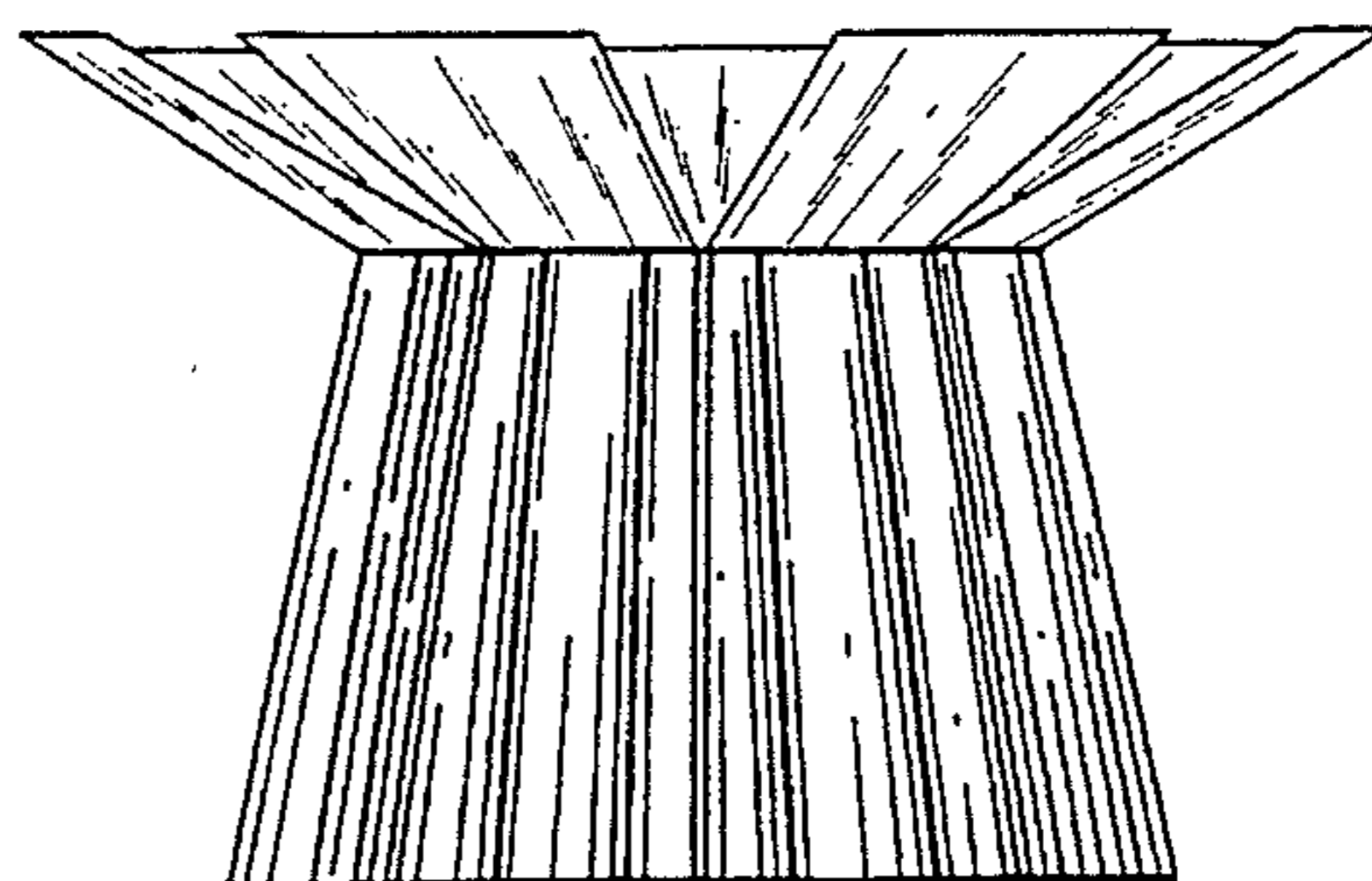

FIG. 33

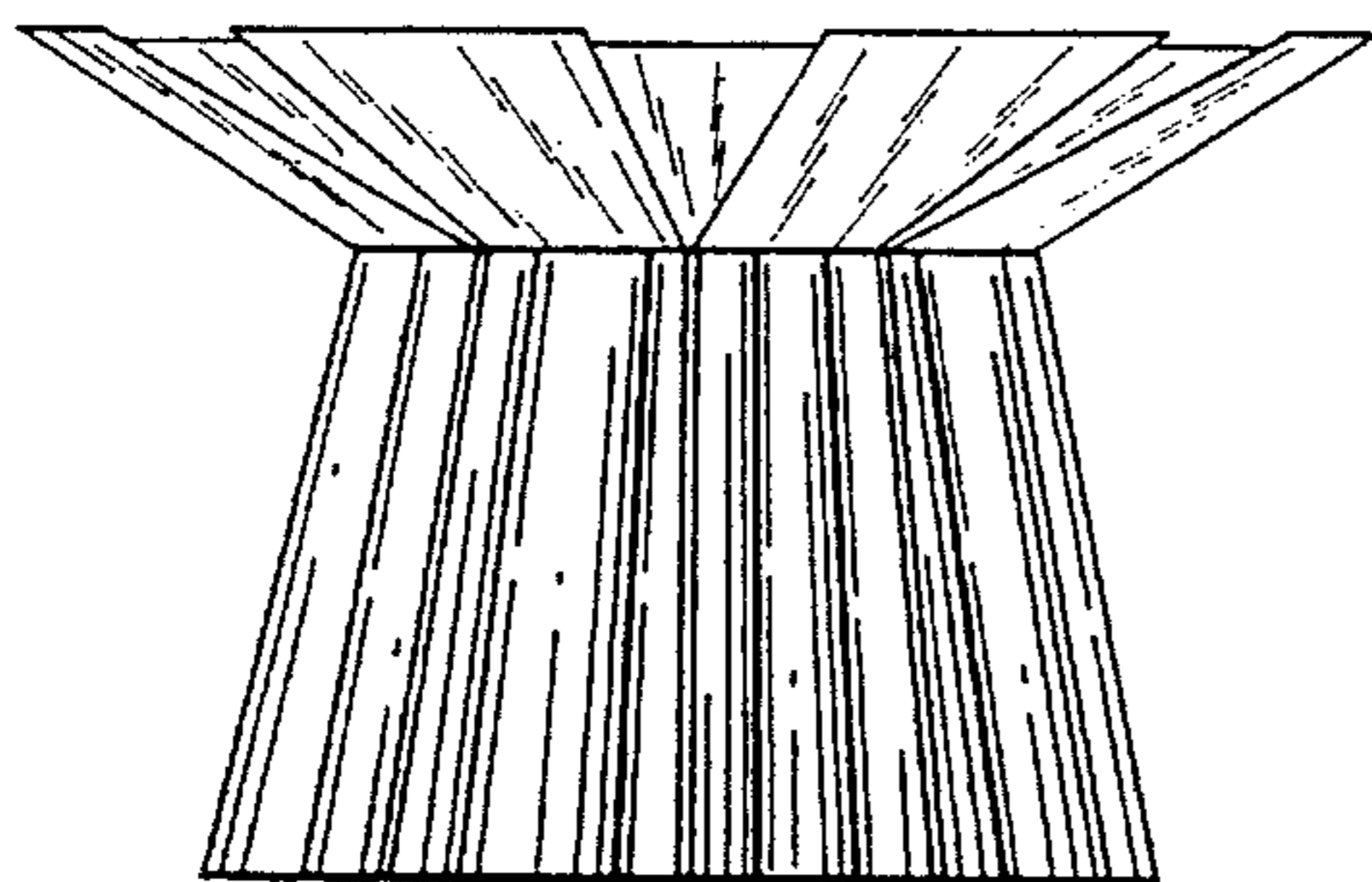

FIG. 34

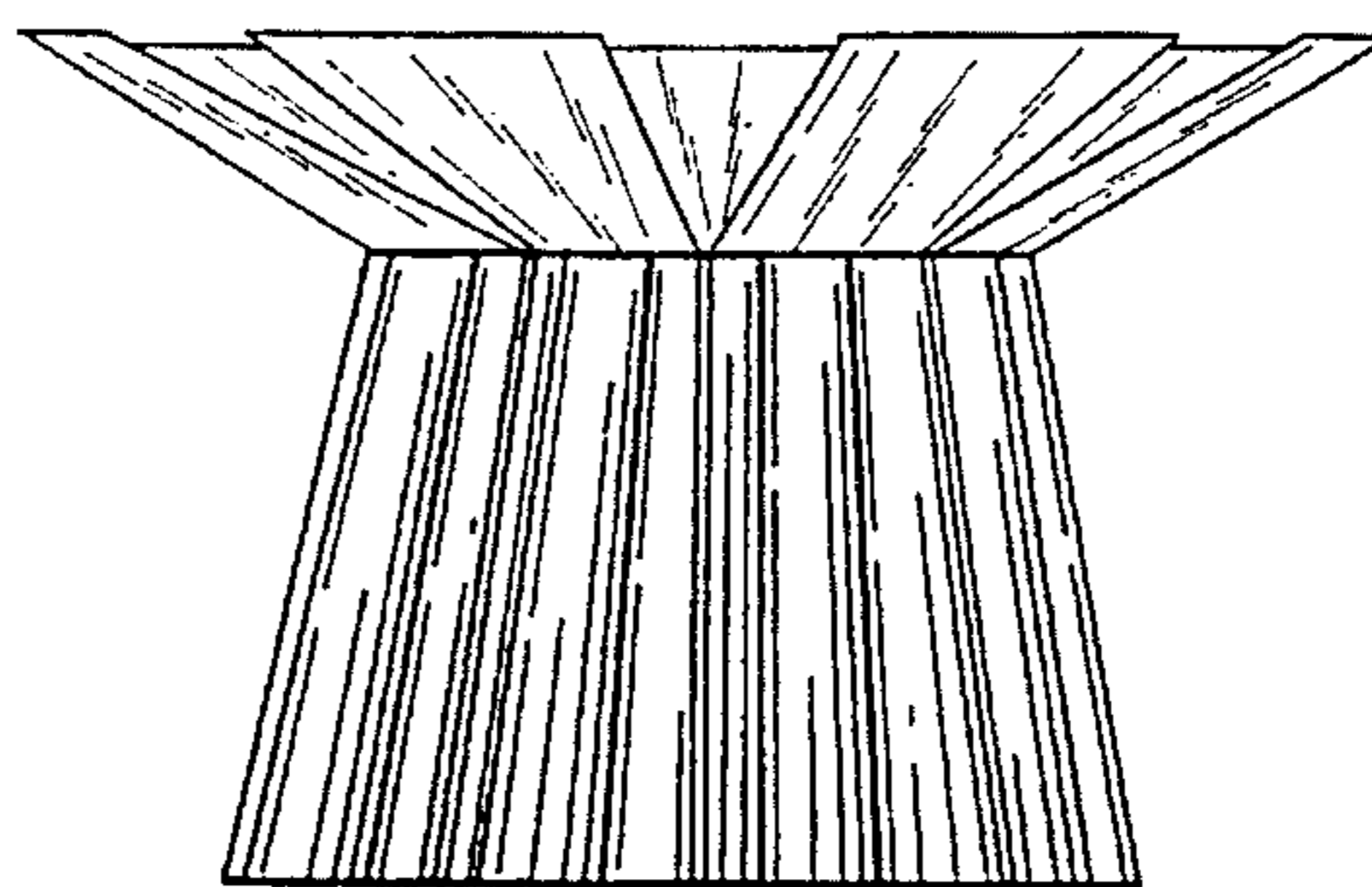

FIG. 35

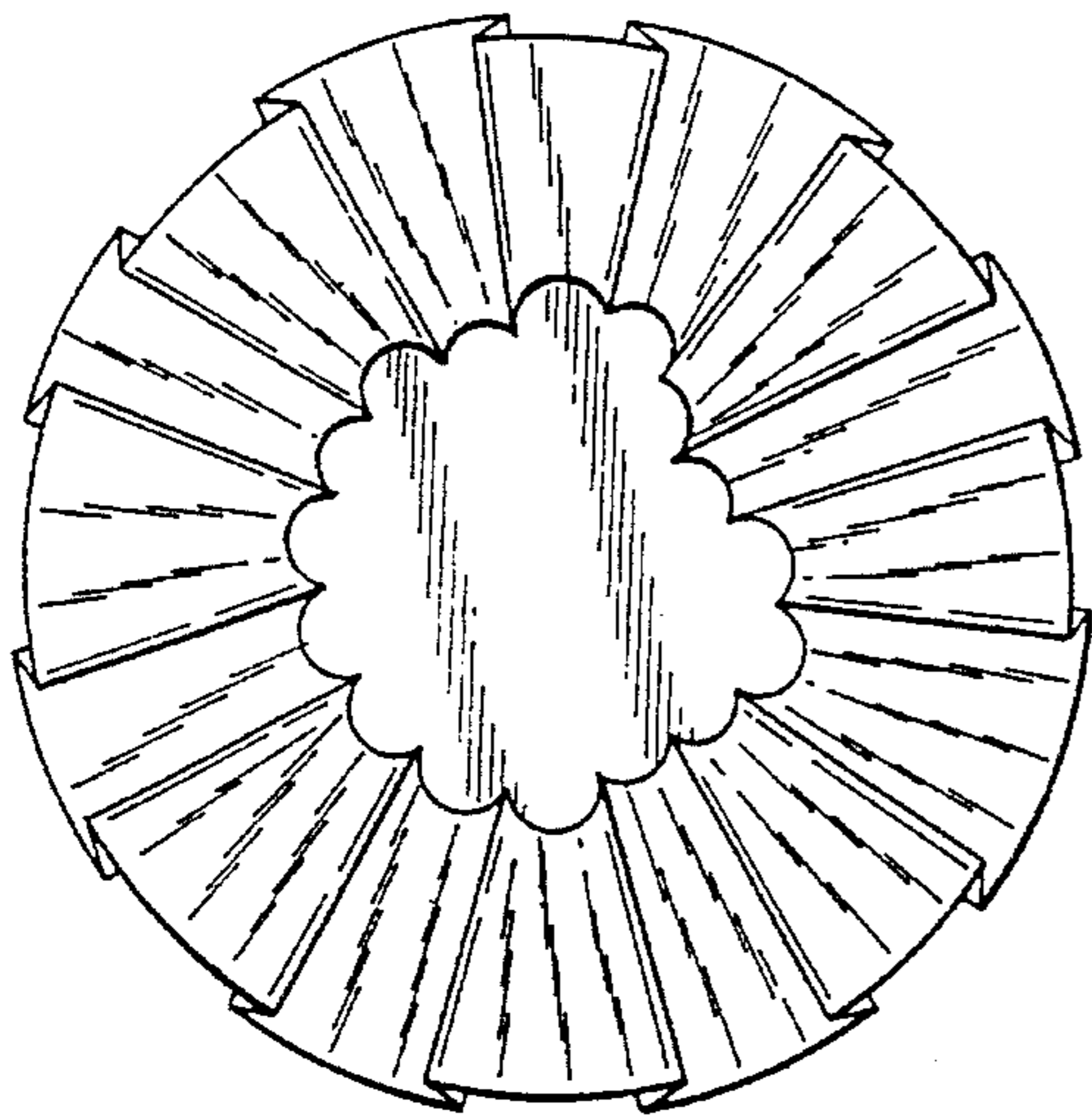

FIG. 35

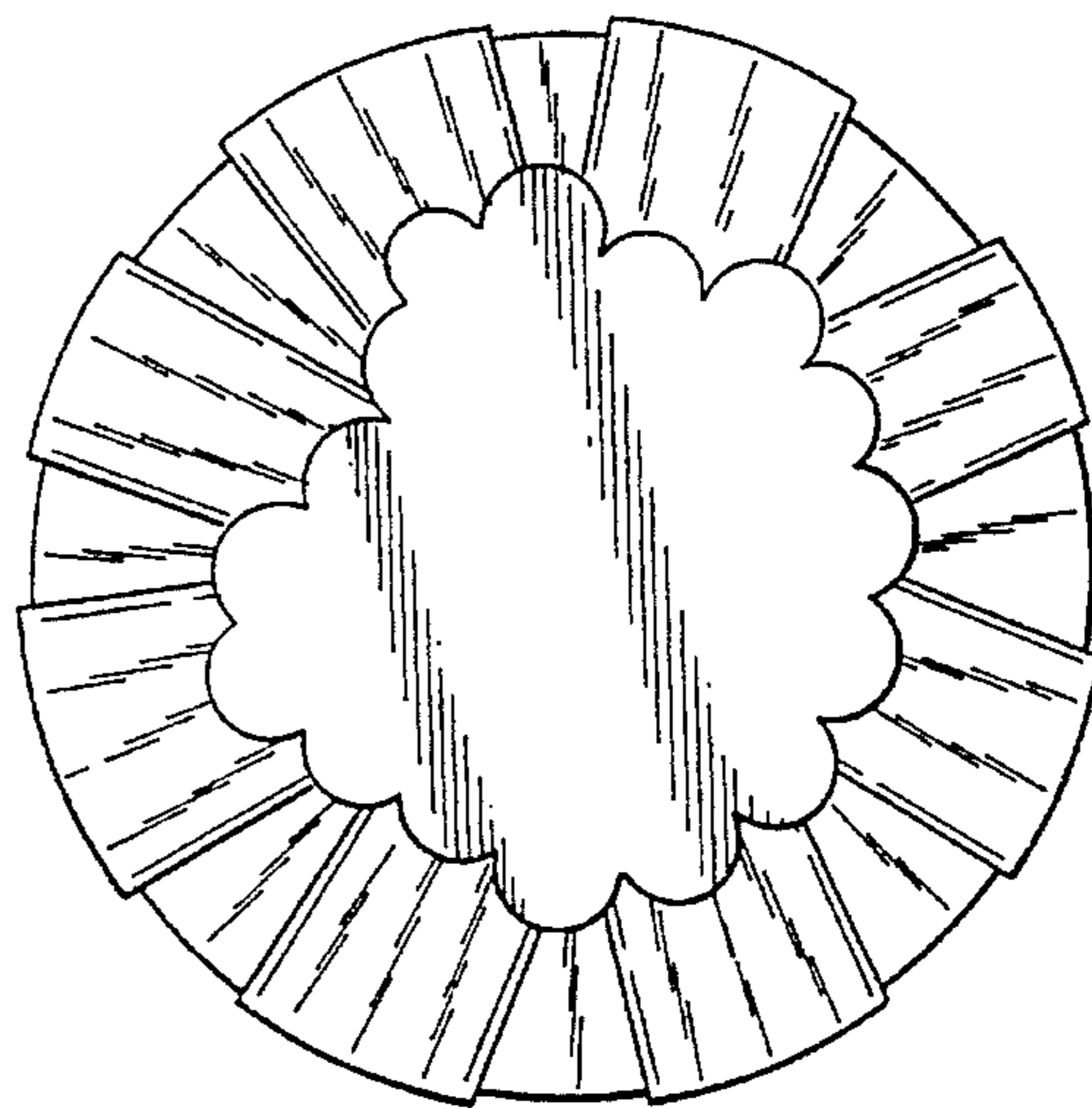

FIG. 37

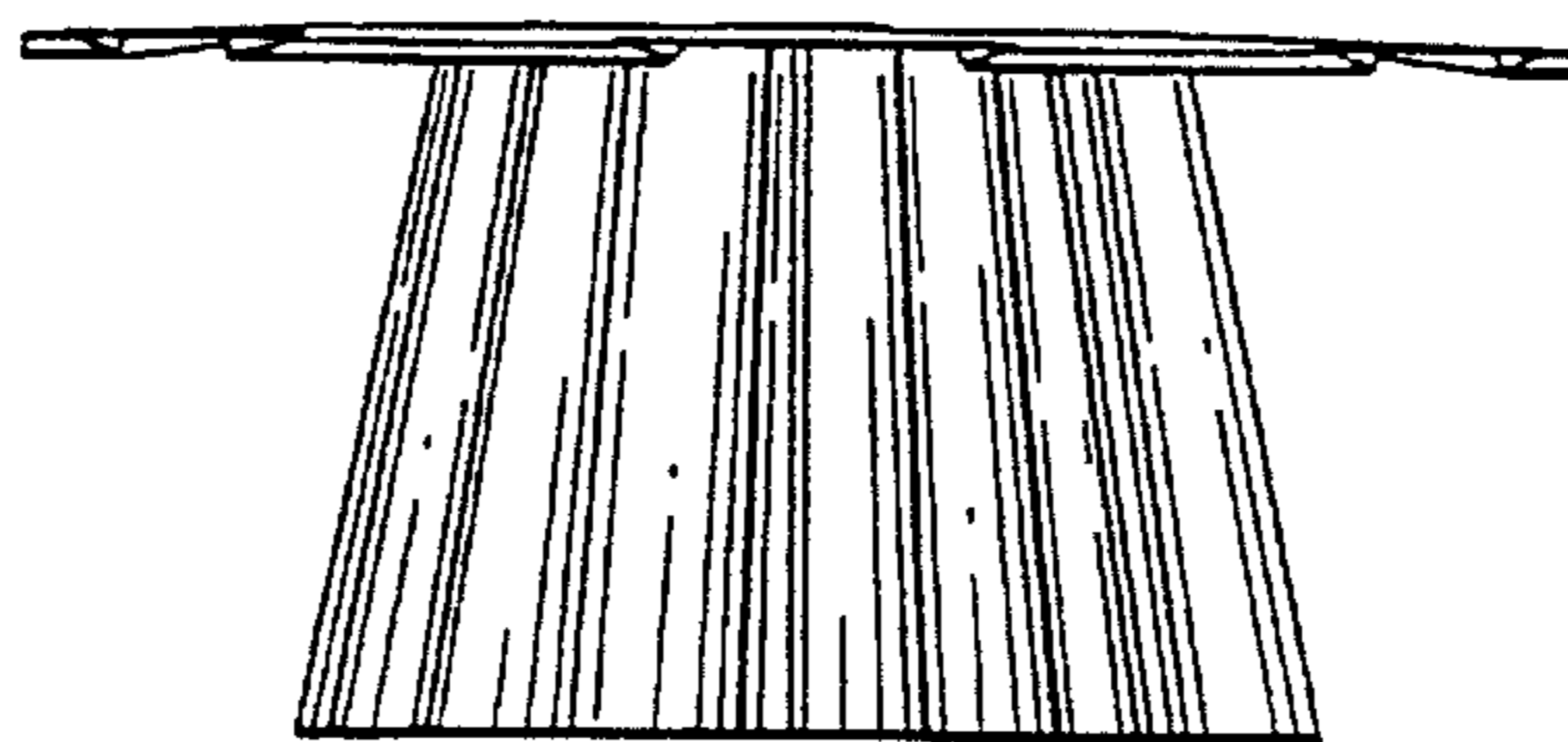

FIG. 38

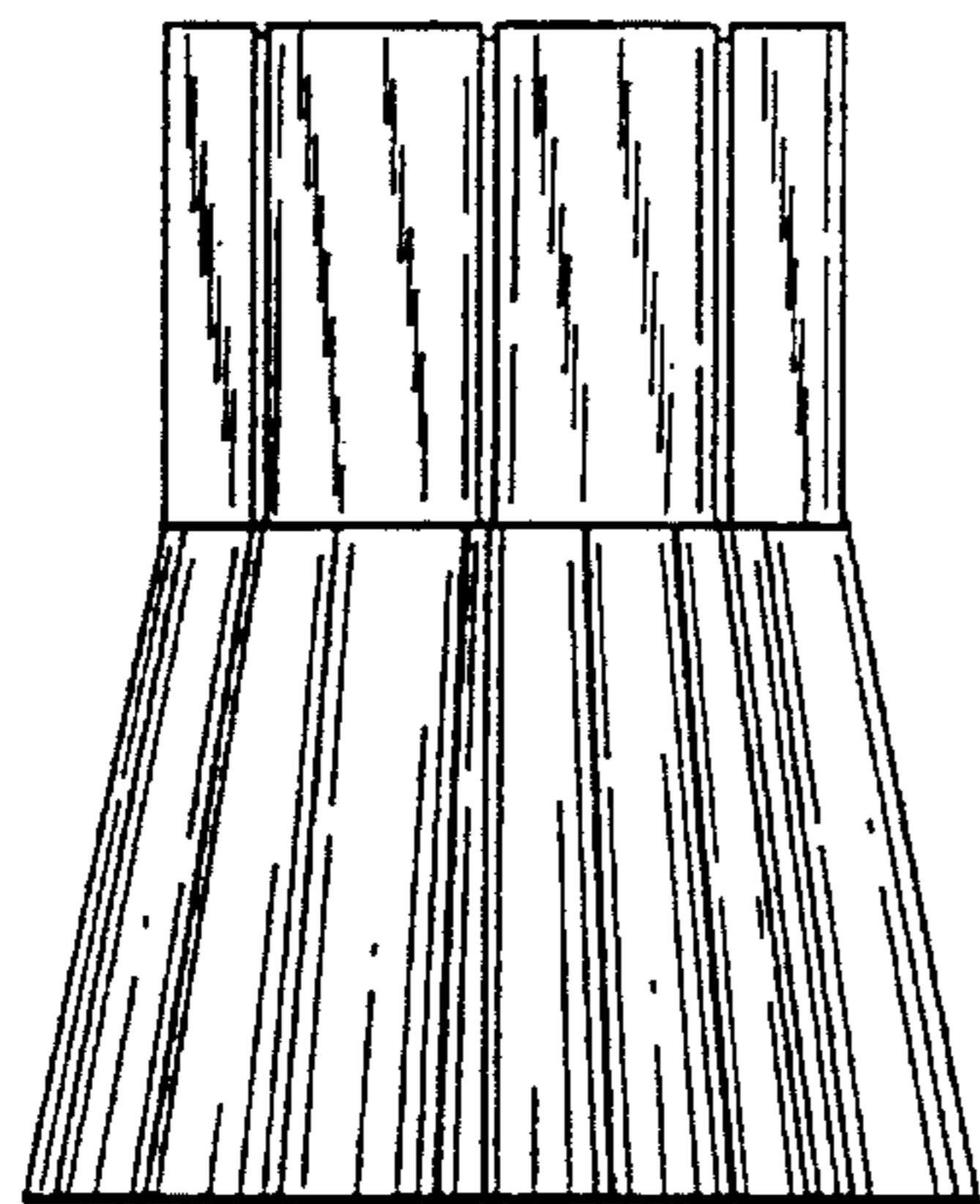

FIG. 39

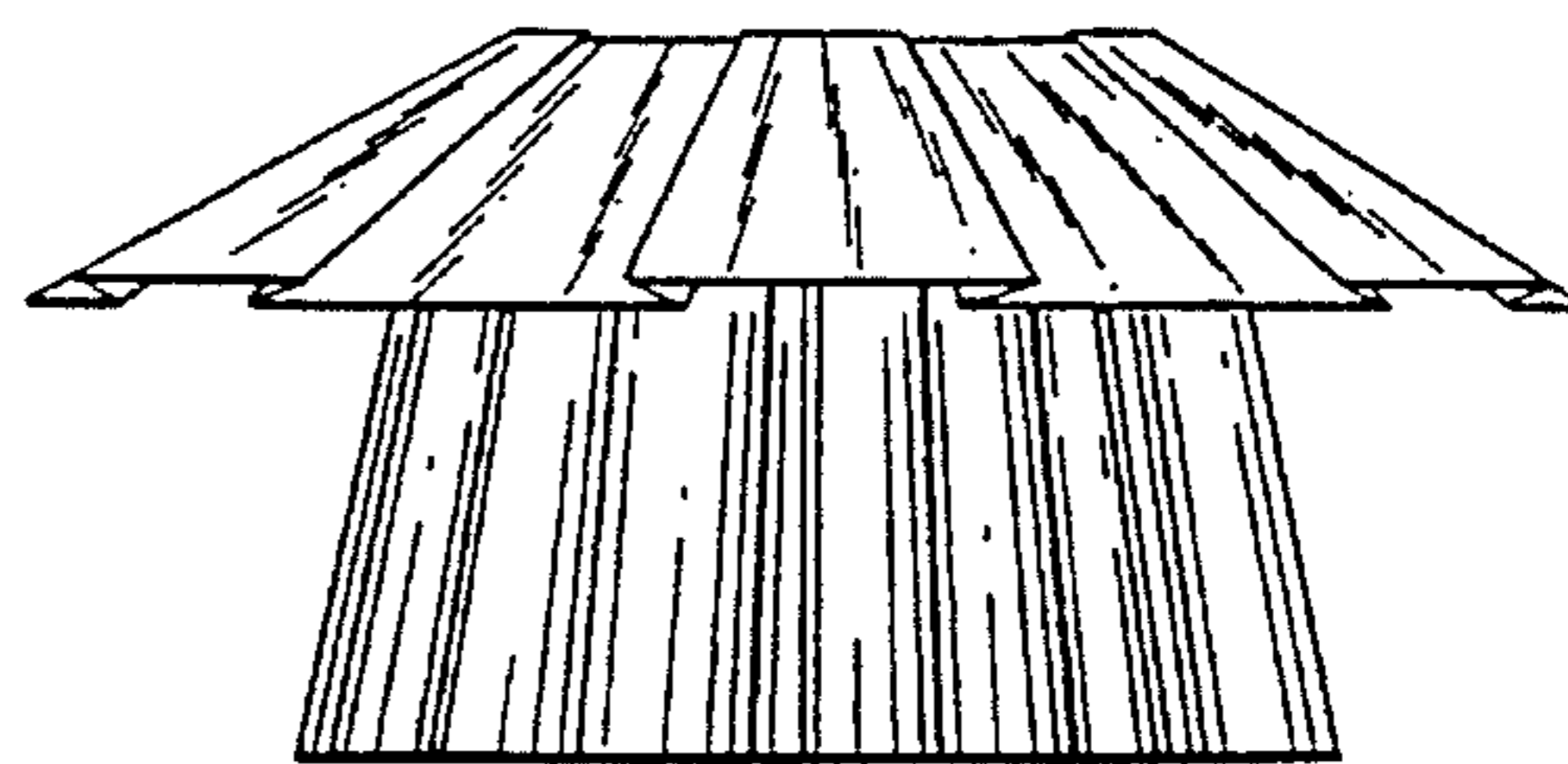

FIG. 40

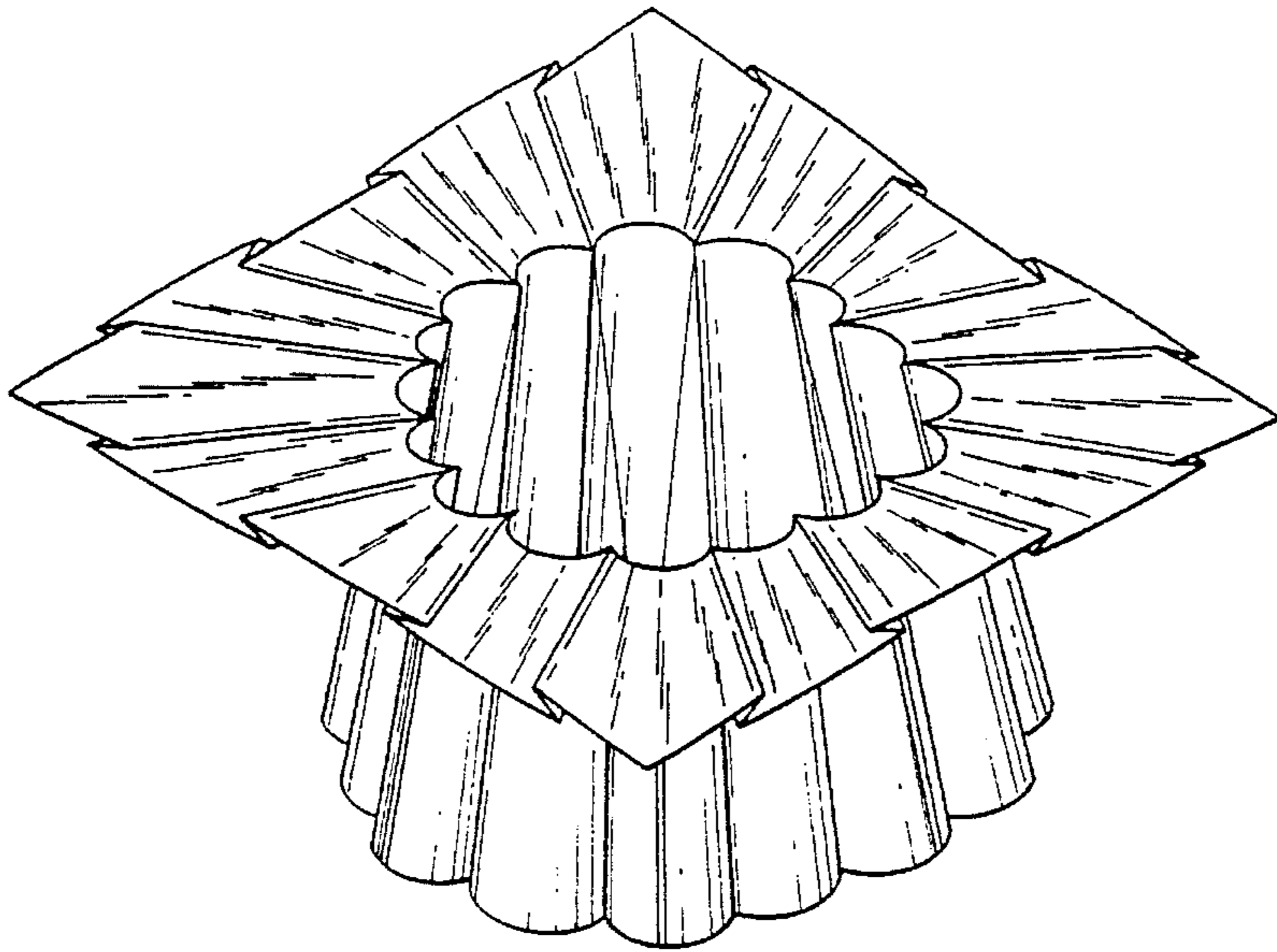

FIG. 41

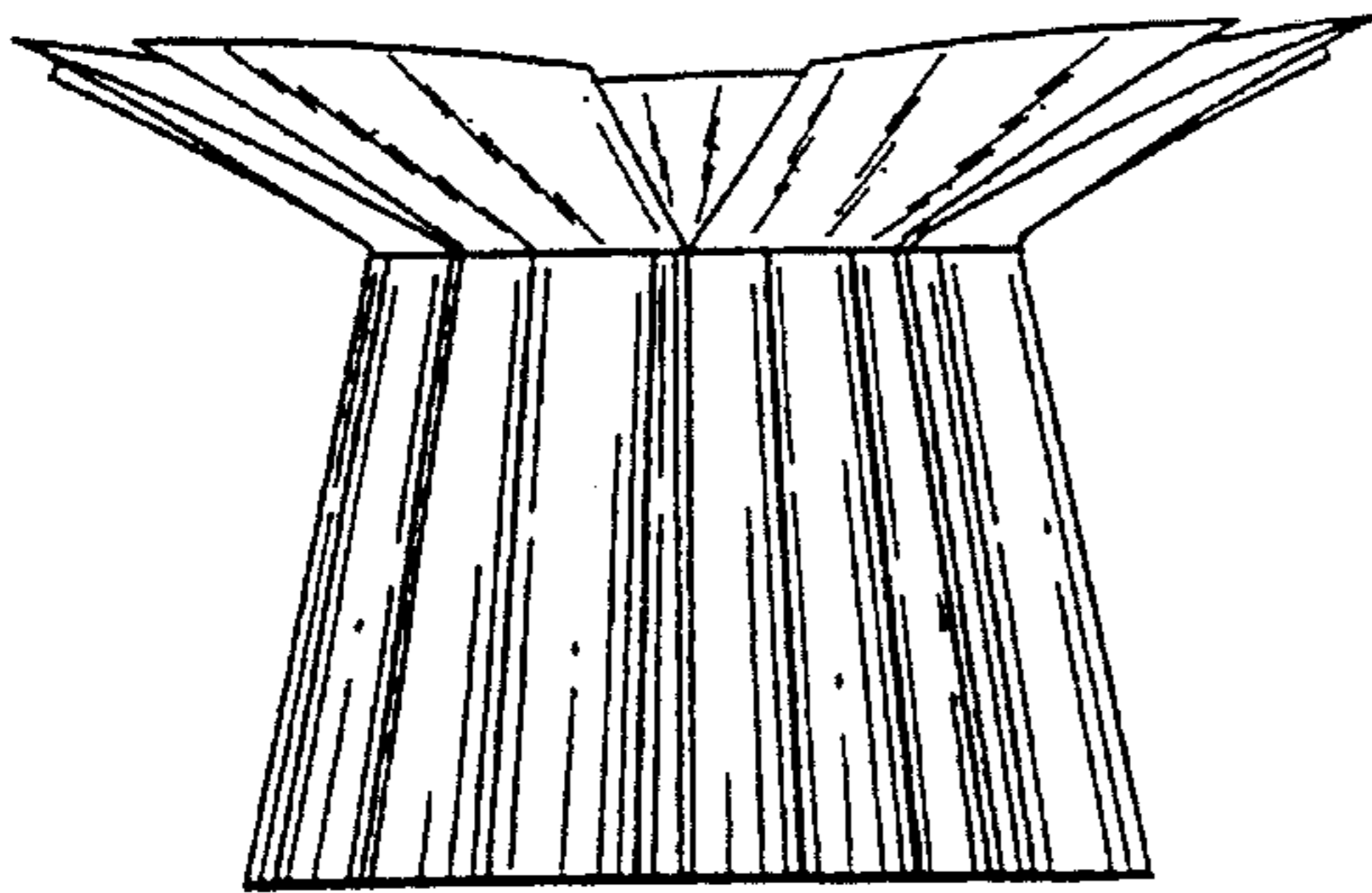

FIG. 42

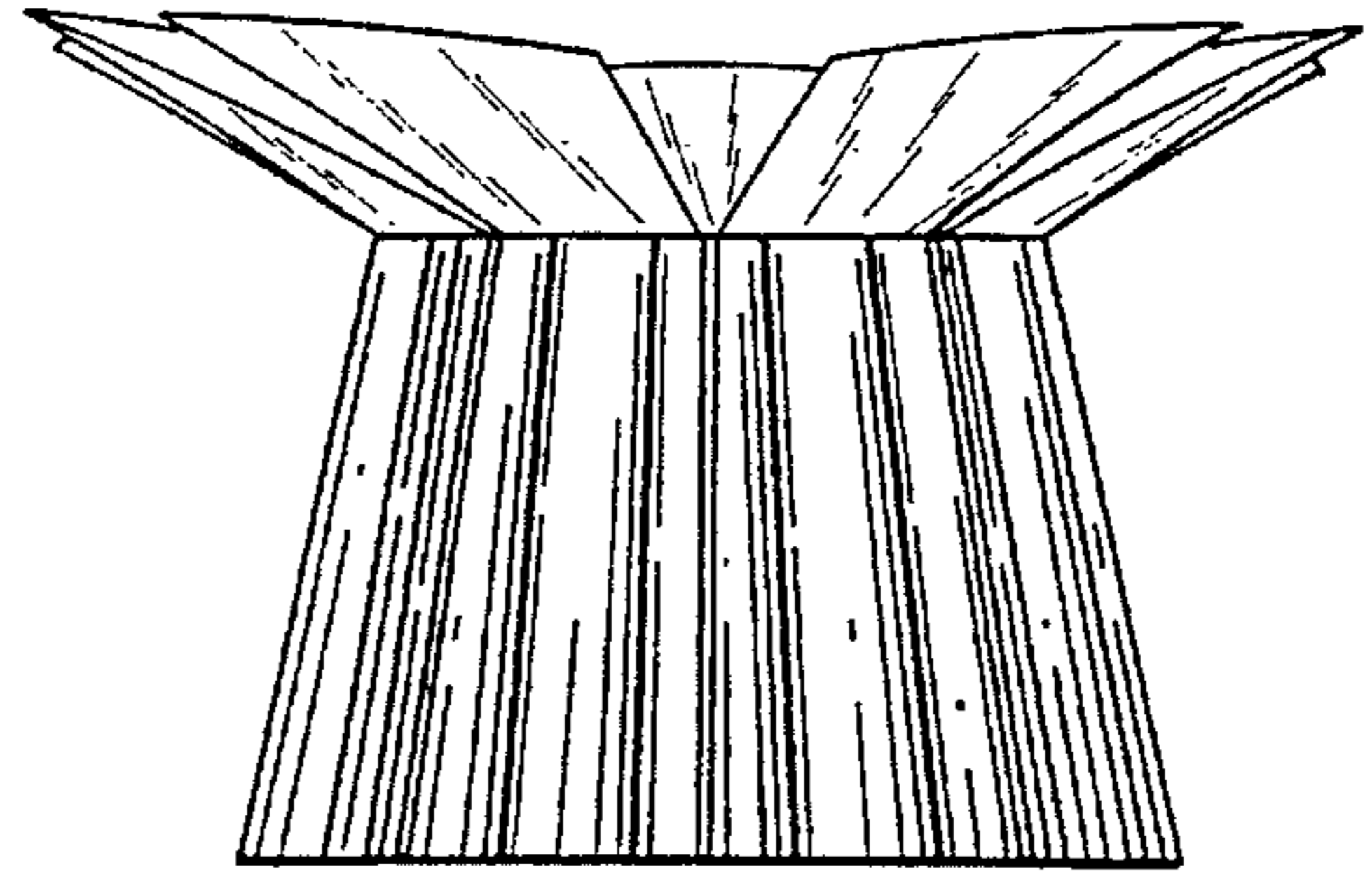

FIG. 43

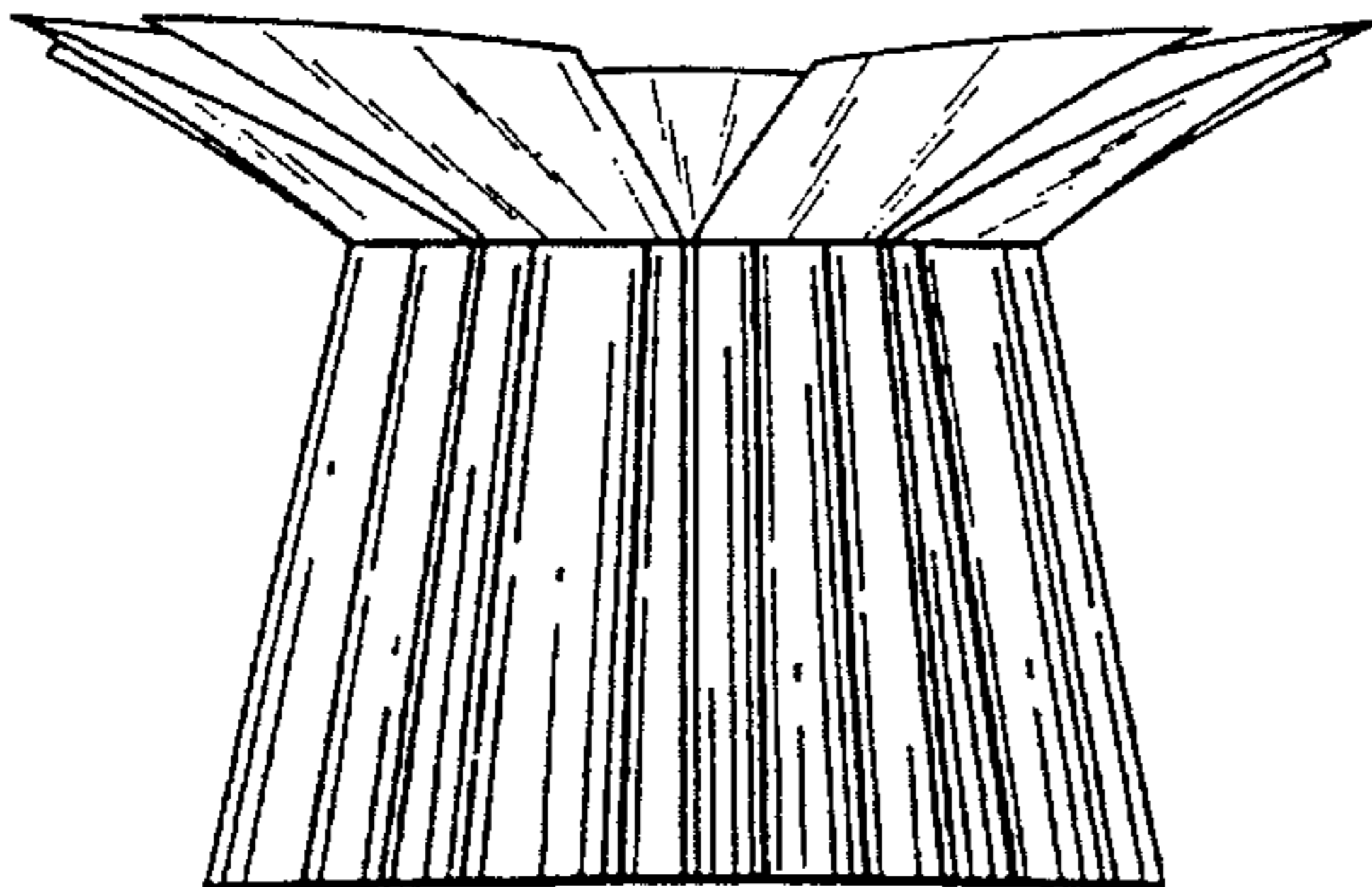

FIG. 44

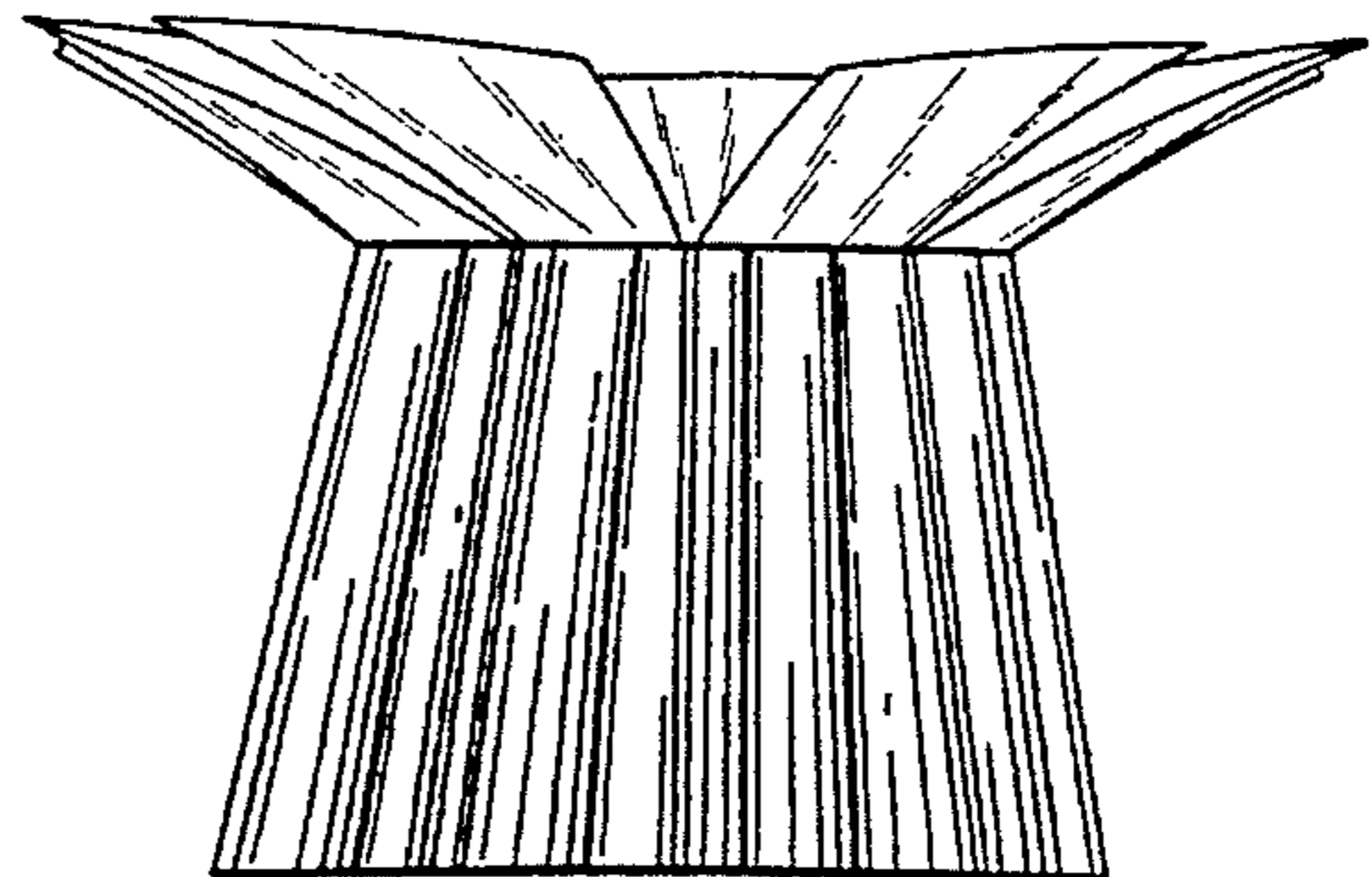

FIG. 45

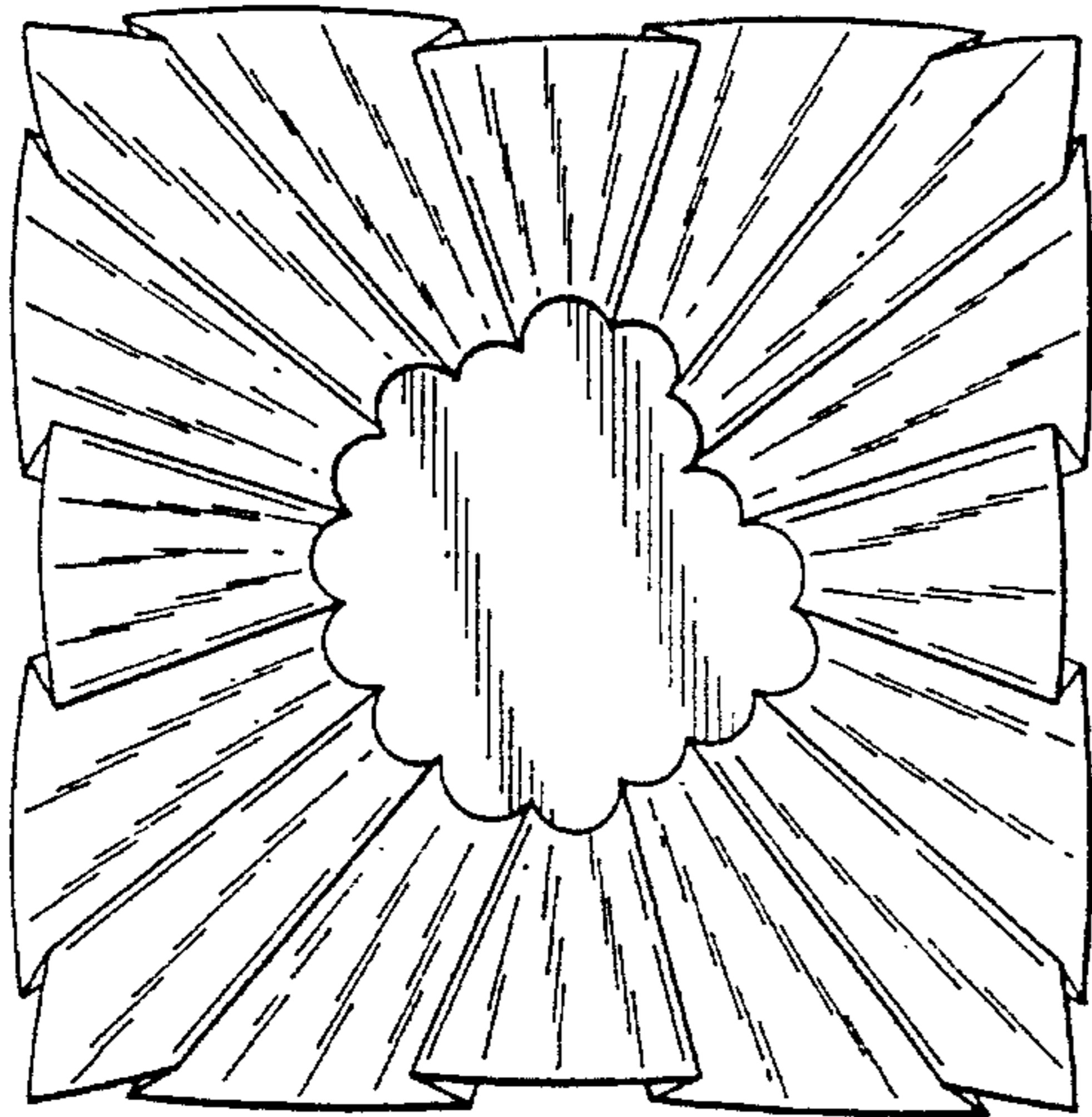

FIG. 46

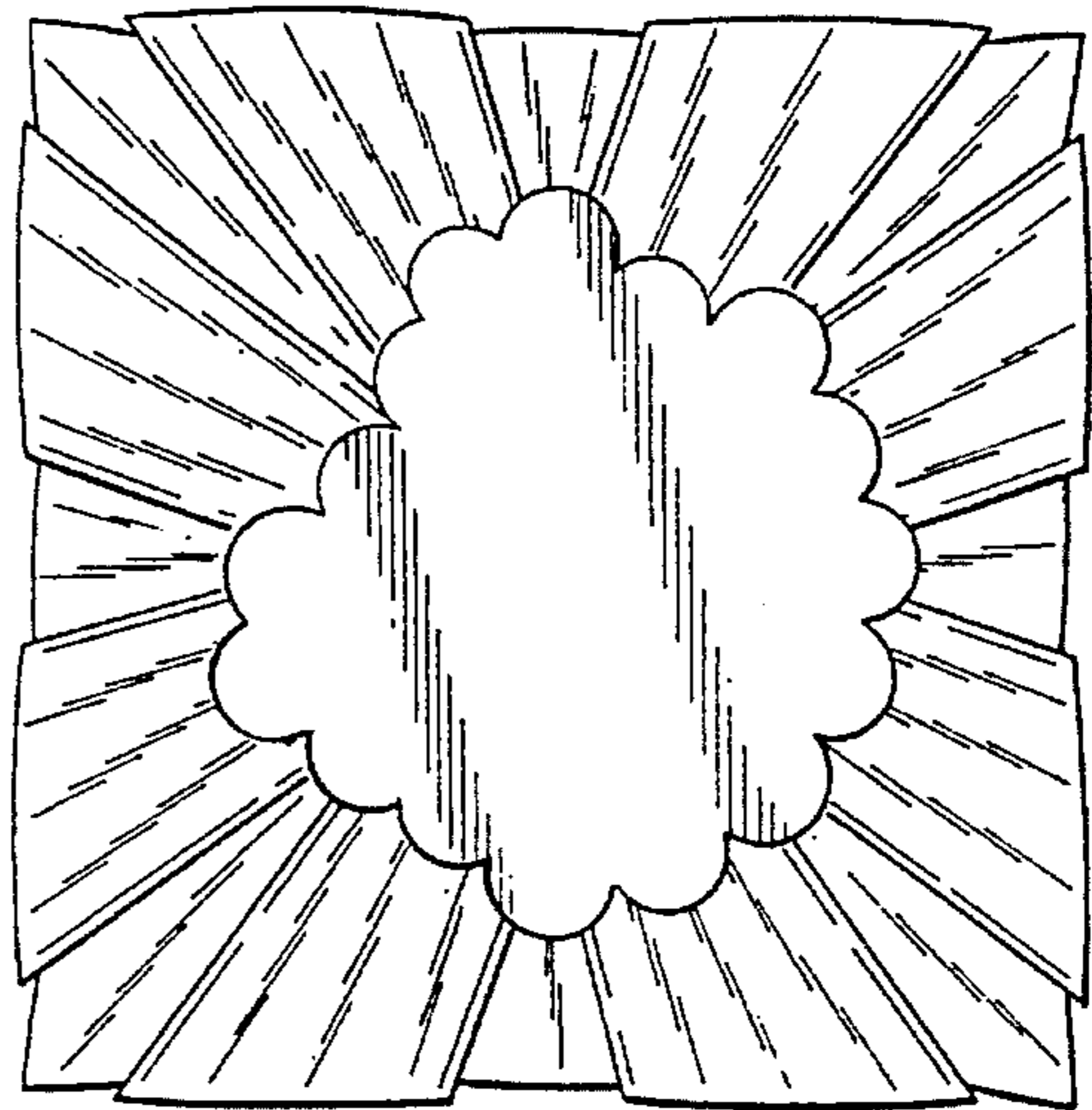

FIG. 47

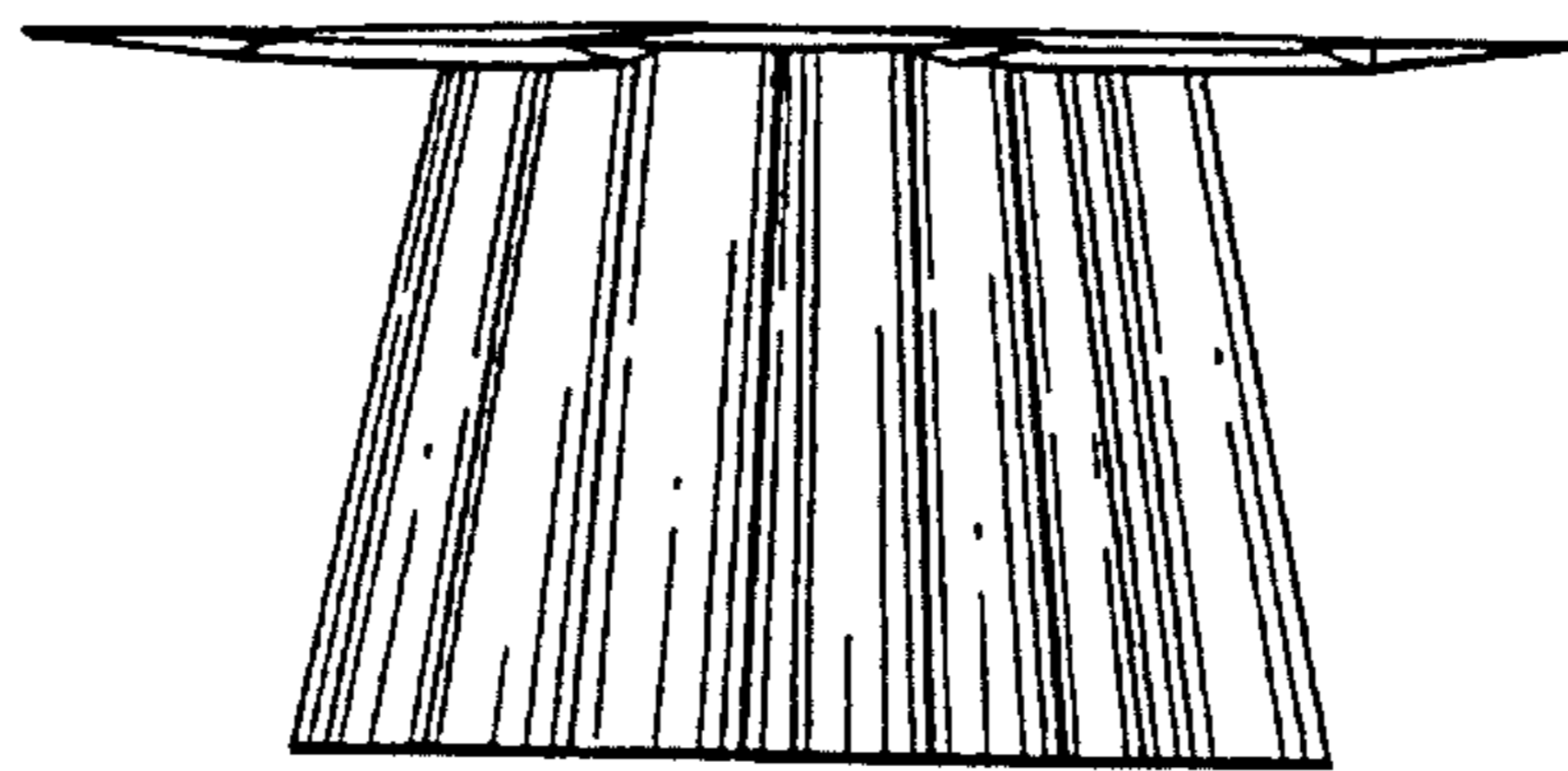

FIG. 48

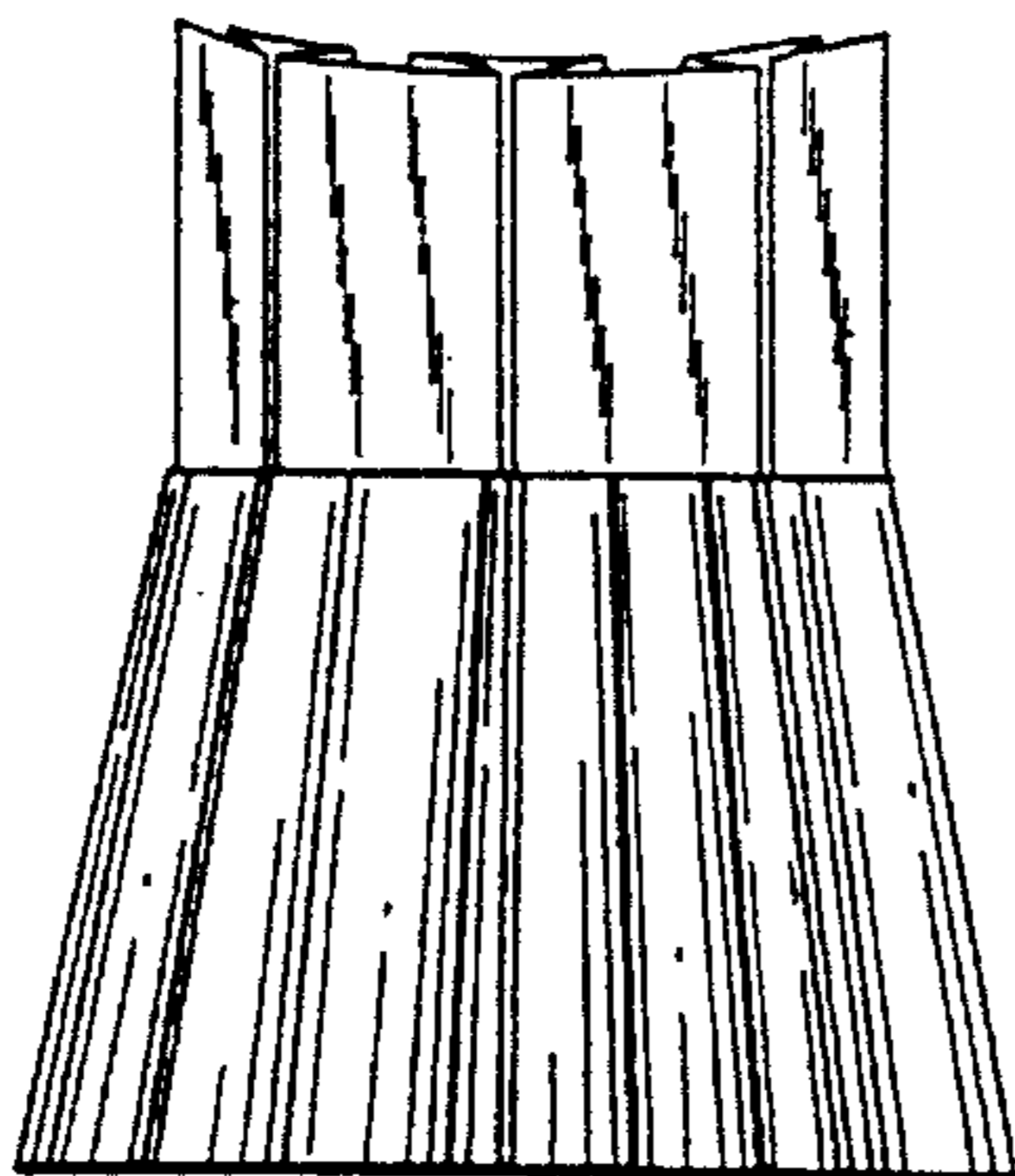

FIG. 49

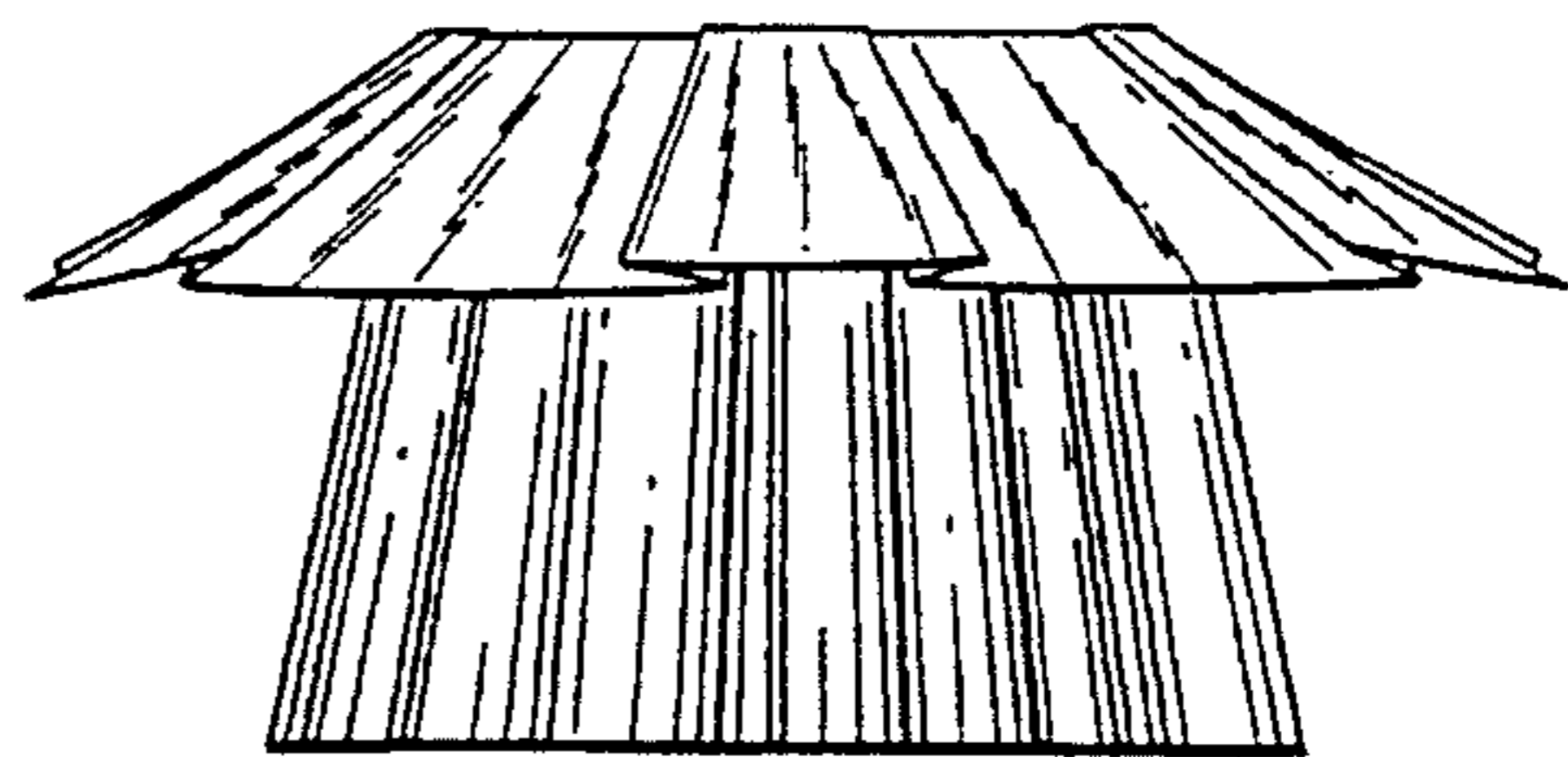

FIG. 50