



US00D369620S

United States Patent [19]

[11] Patent Number: **Des. 369,620**

Boutsakis et al.

[45] Date of Patent: ****May 7, 1996**

[54] **DESK TOP ORGANIZER**

[75] Inventors: **Alex Boutsakis**, Camberwell; **Michael Psaltis**, Heidelberg, both of Australia

[73] Assignee: **Chronos Designs Pty Ltd**, Preston, Australia

[**] Term: **14 Years**

[21] Appl. No.: **19,863**

[22] Filed: **Feb. 22, 1994**

[30] **Foreign Application Priority Data**

Aug. 23, 1993 [AU] Australia 2609/93

[52] U.S. Cl. **D19/90; D19/86**

[58] Field of Search D19/65, 75, 78, D19/86, 90, 91, 95, 99, 100; 211/45, 50, 55, 10

[56] **References Cited**

U.S. PATENT DOCUMENTS

D. 96,826	9/1935	Estrella	D19/86
D. 132,746	6/1942	Schenker	D19/86
D. 308,228	5/1990	Gecchelin	D19/90
1,316,015	9/1919	Bristow et al.	211/11

Primary Examiner—Martie Thompson
Attorney, Agent, or Firm—Foley & Lardner

[57] **CLAIM**

The ornamental design for a desk top organizer, as shown.

DESCRIPTION

FIG. 1 is a perspective view taken from the front, top left, of a first embodiment of the design;
 FIG. 2 is a front elevation view of the first embodiment;
 FIG. 3 is a rear elevation view of the first embodiment;
 FIG. 4 is a top plan view of the first embodiment;
 FIG. 5 is a bottom plan view of the first embodiment;
 FIG. 6 is a left side elevation view of the first embodiment;
 FIG. 7 is a right side elevation view of the first embodiment;
 FIG. 8 is a perspective view taken from the front, top left, of a second embodiment of the design;
 FIG. 9 is a front elevation view of the second embodiment;
 FIG. 10 is a rear elevation view of the second embodiment;
 FIG. 11 is a bottom plan view of the second embodiment;
 FIG. 12 is a top plan view of the second embodiment;
 FIG. 13 is a left side elevation view of the second embodiment; and,
 FIG. 14 is a right side elevation view of the second embodiment.

1 Claim, 10 Drawing Sheets

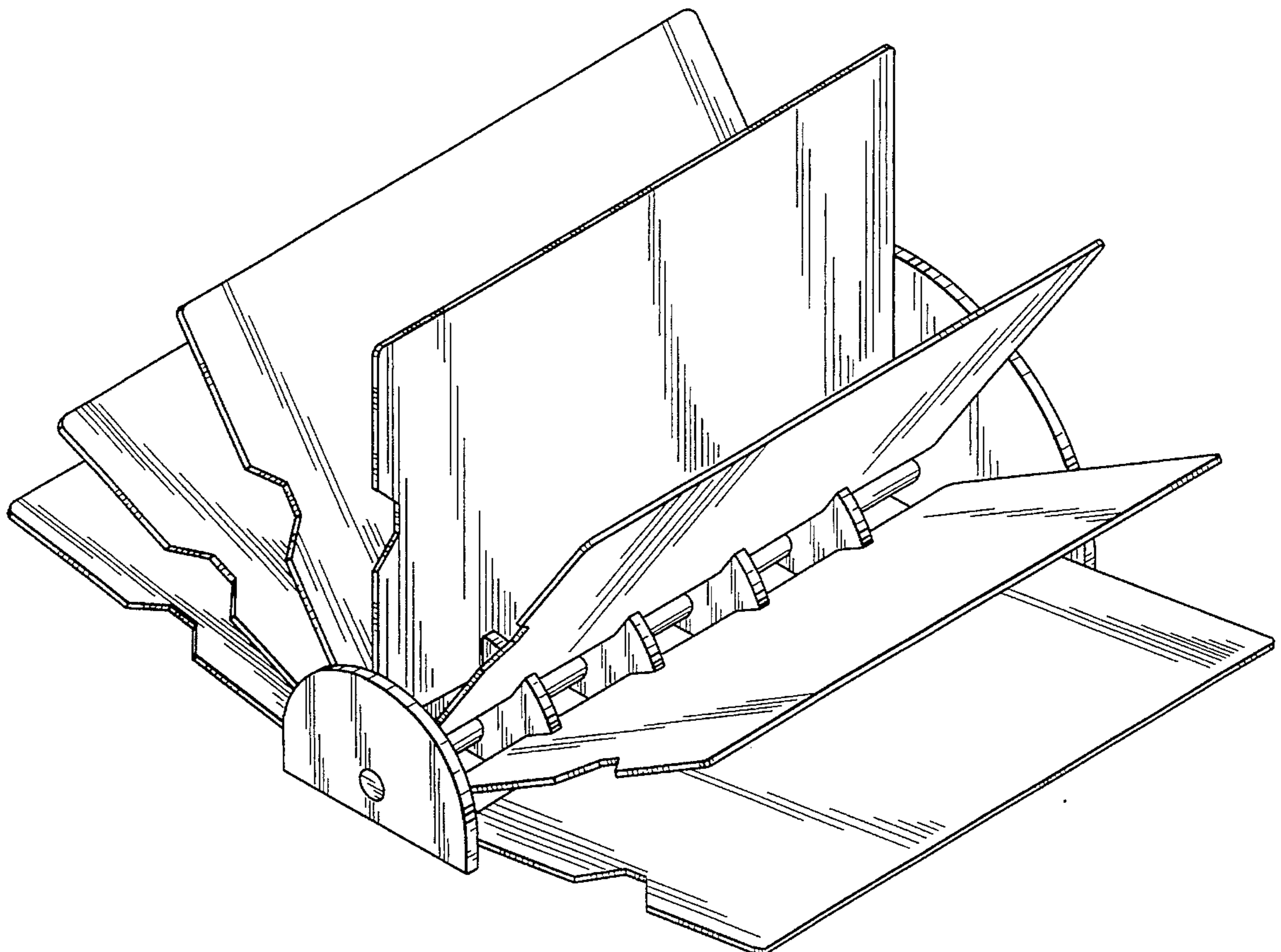

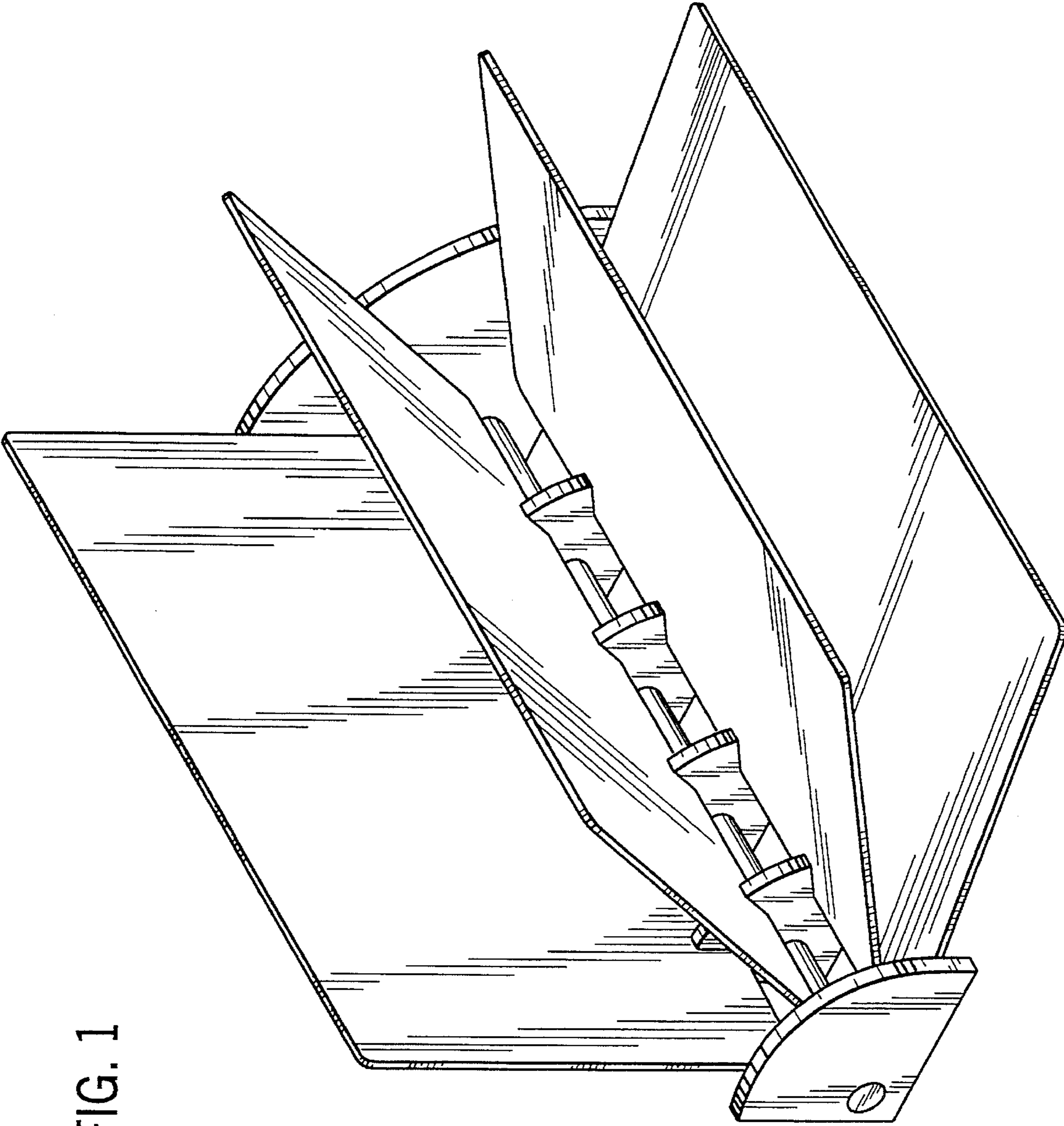

FIG. 1

FIG. 2

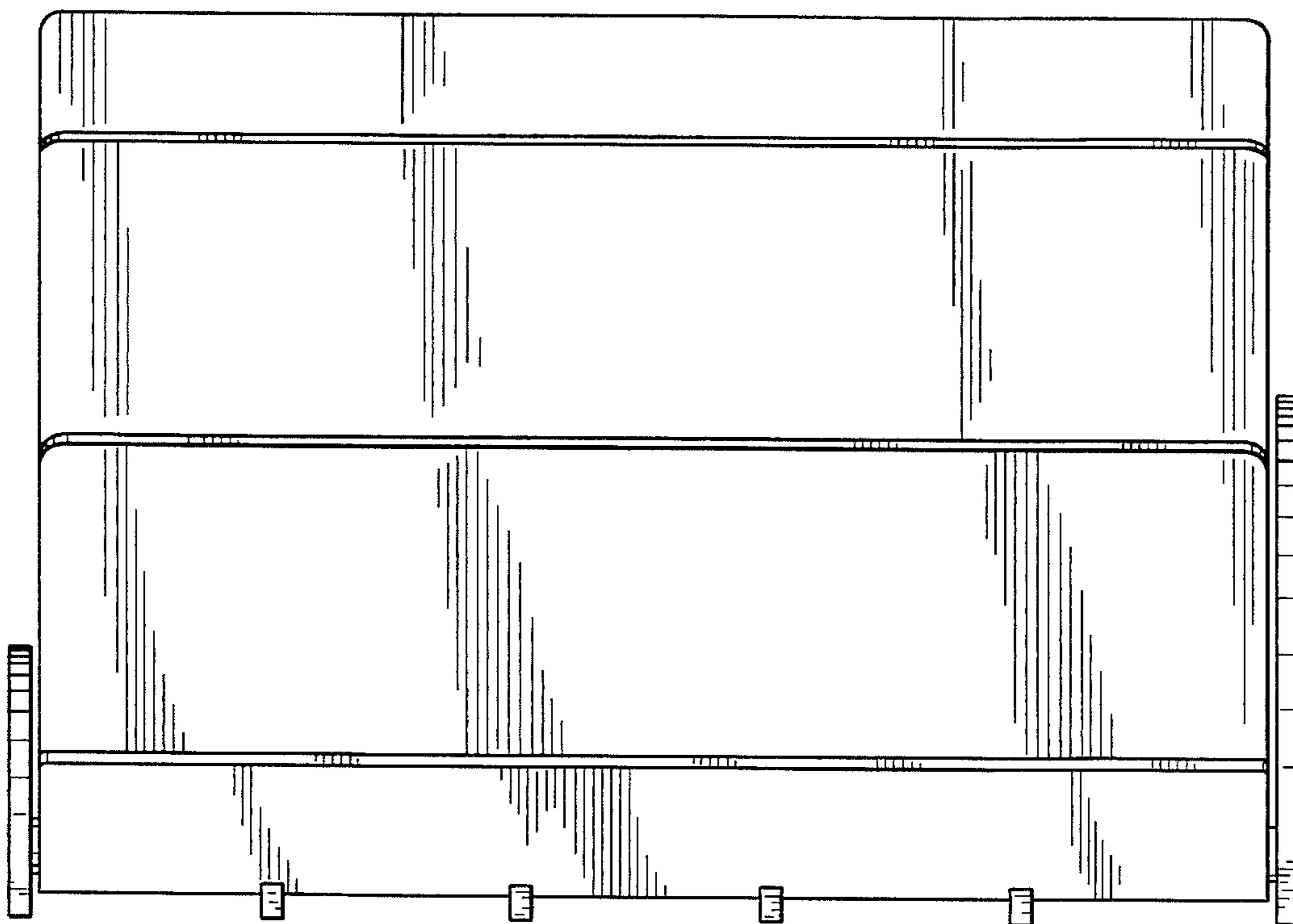

FIG. 3

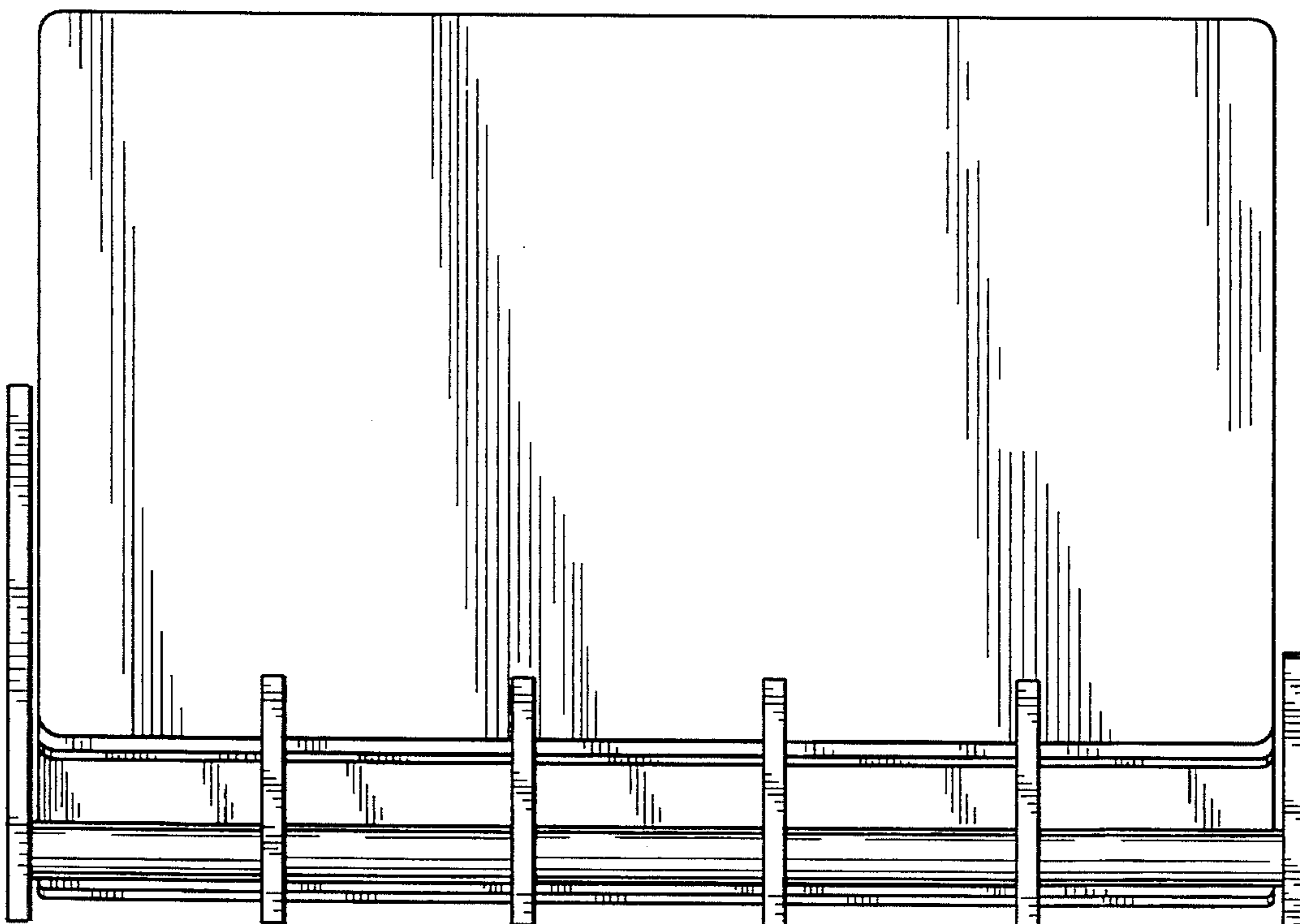

FIG. 4

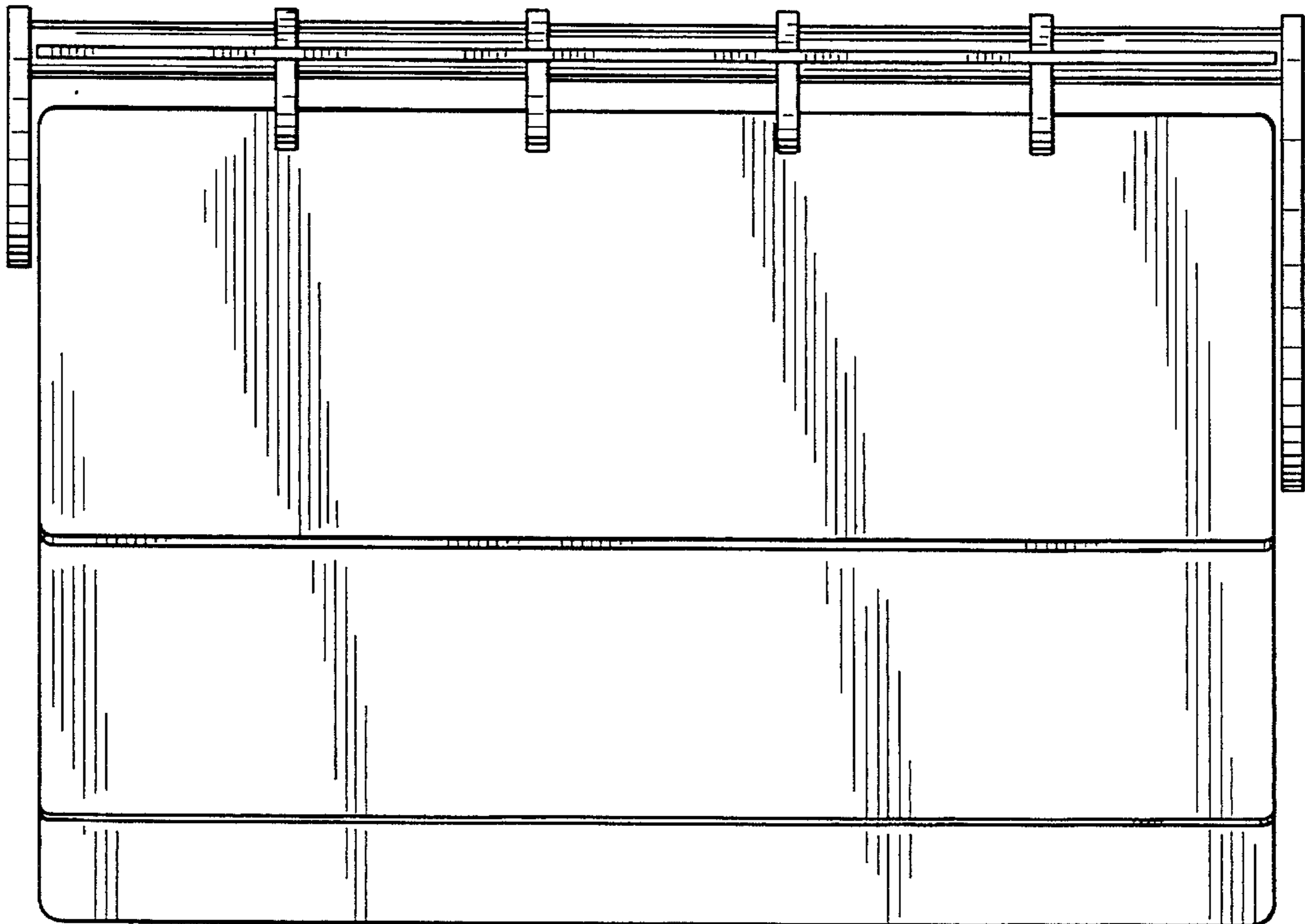

FIG. 5

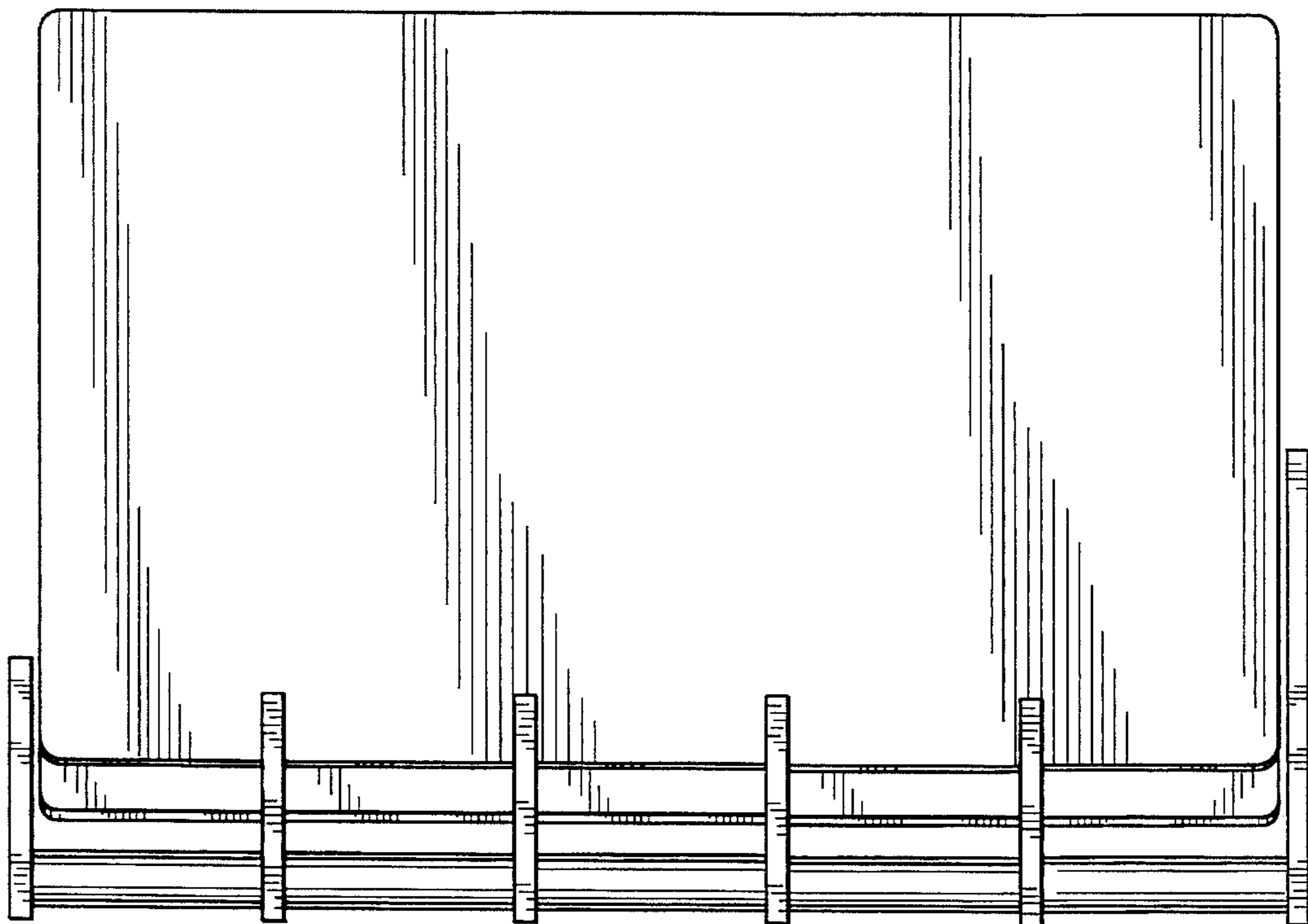

FIG. 6

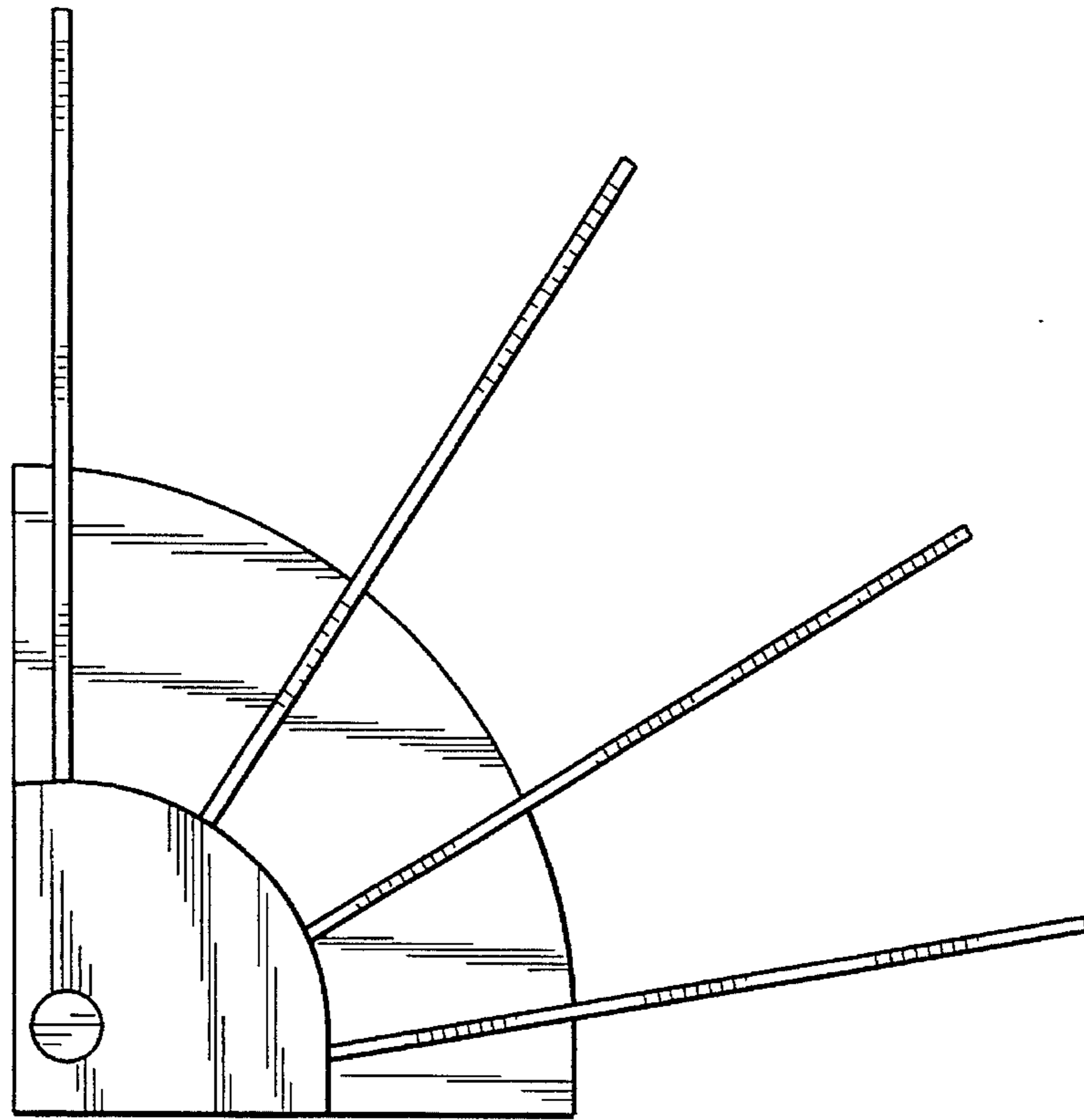
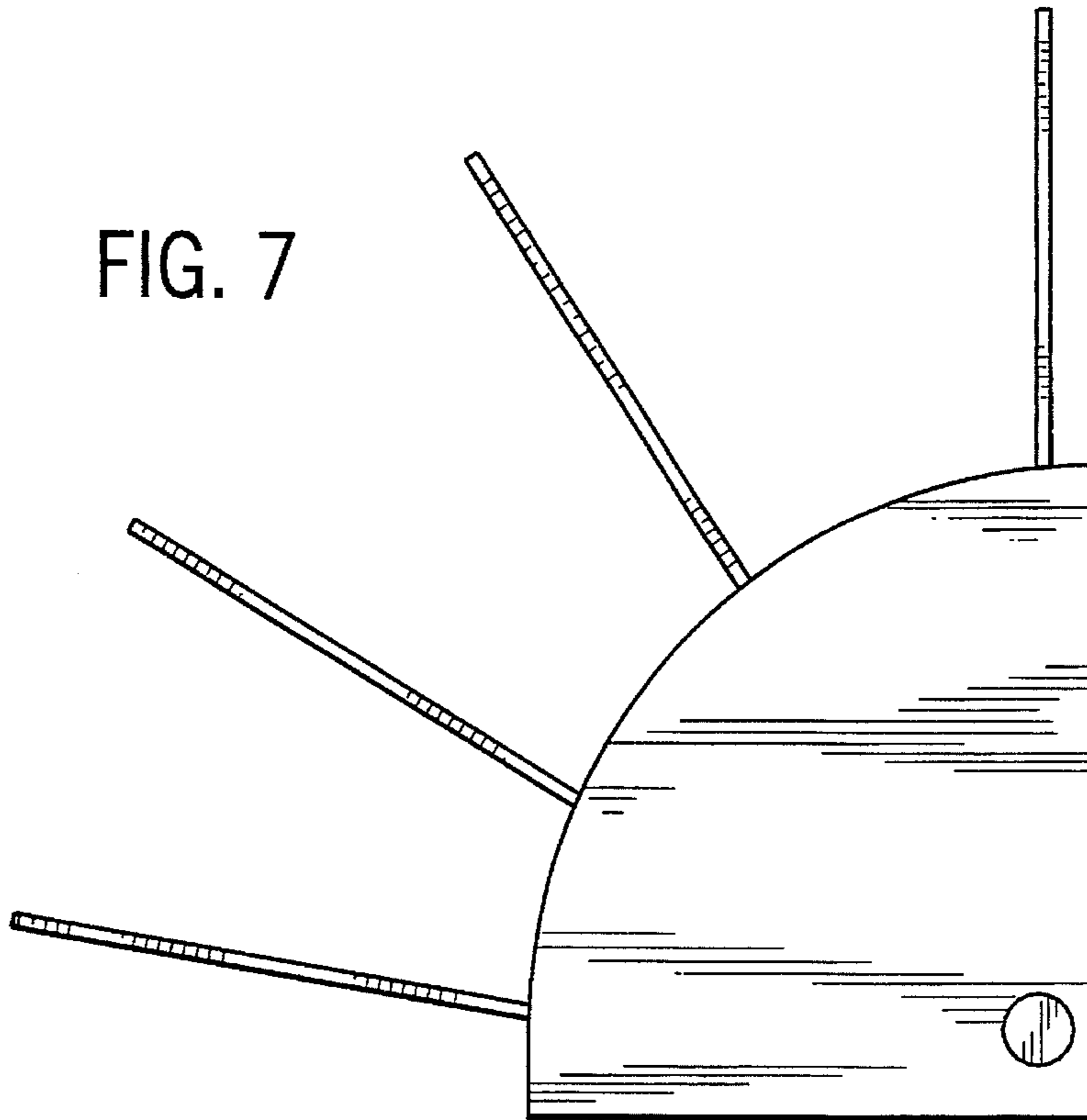

FIG. 7



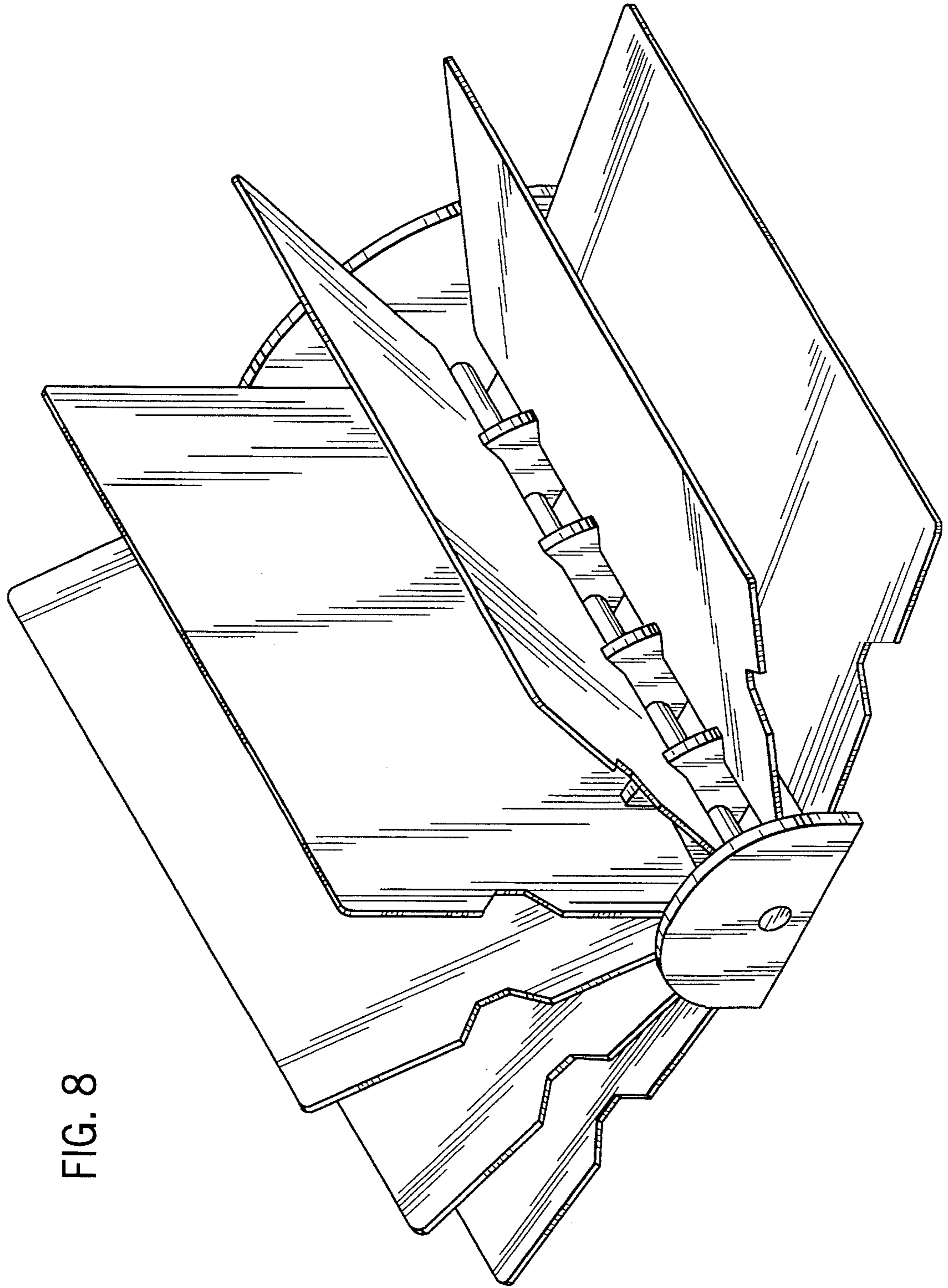

FIG. 8

FIG. 9

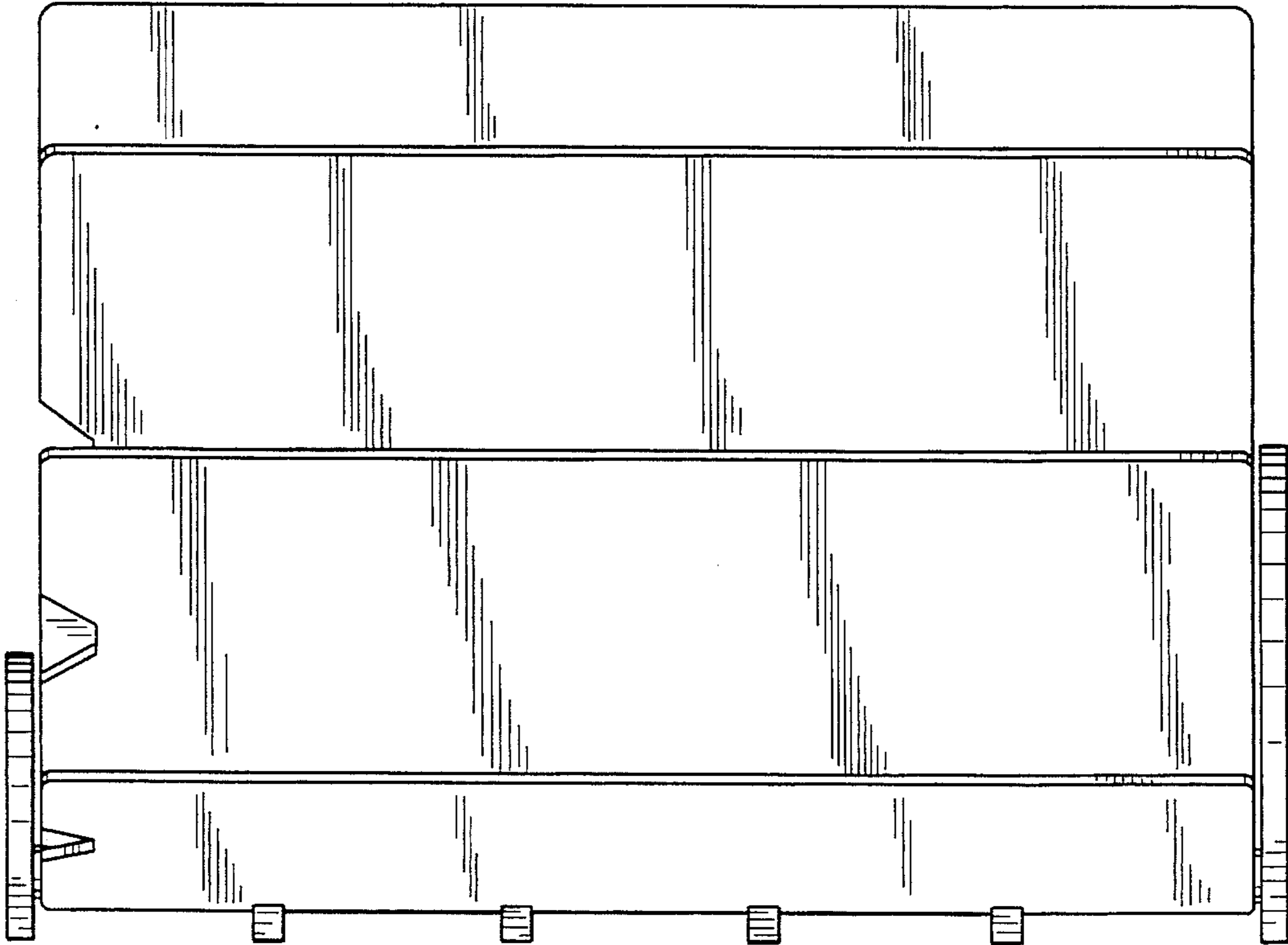

FIG. 10

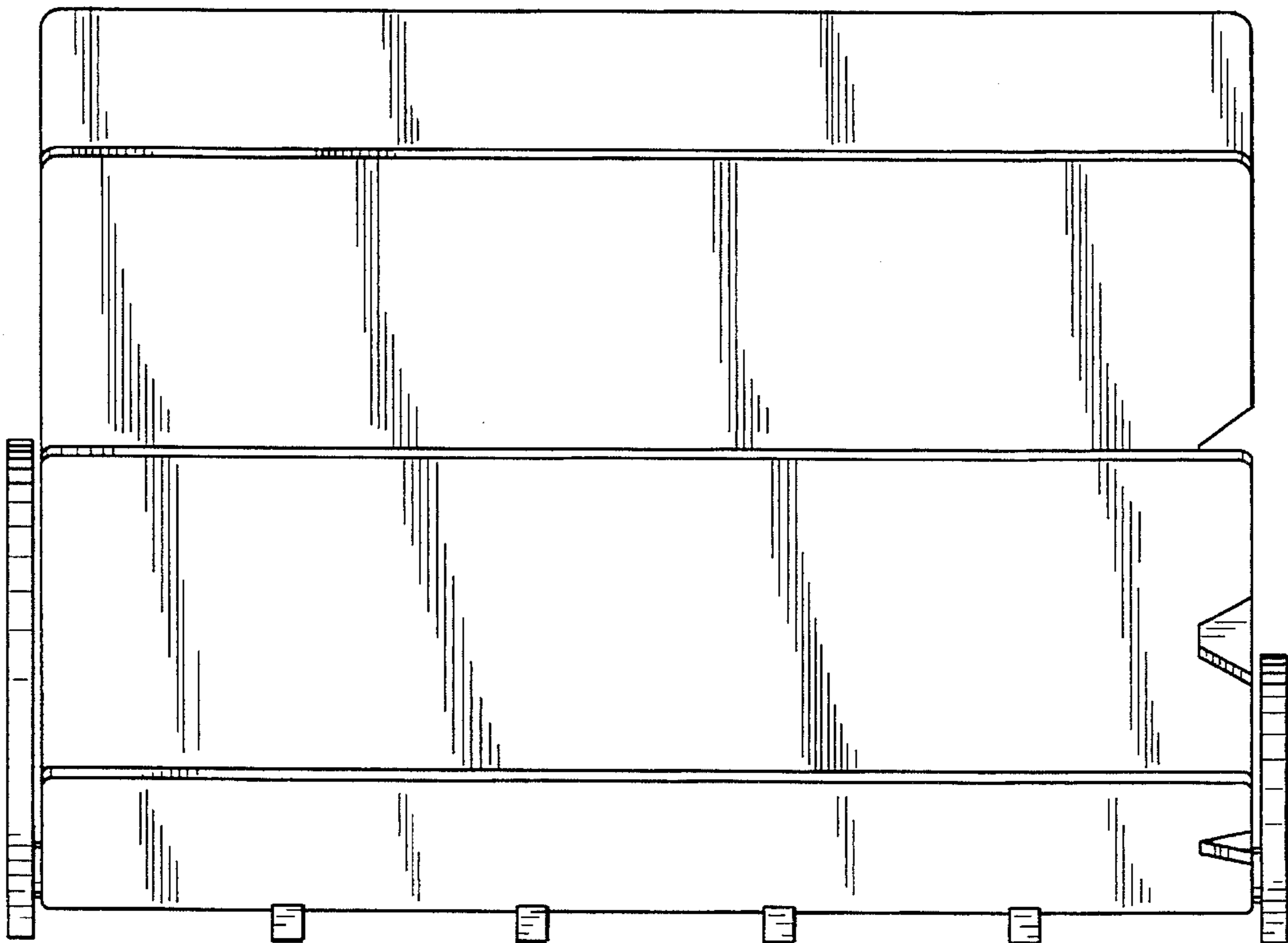

FIG. 11

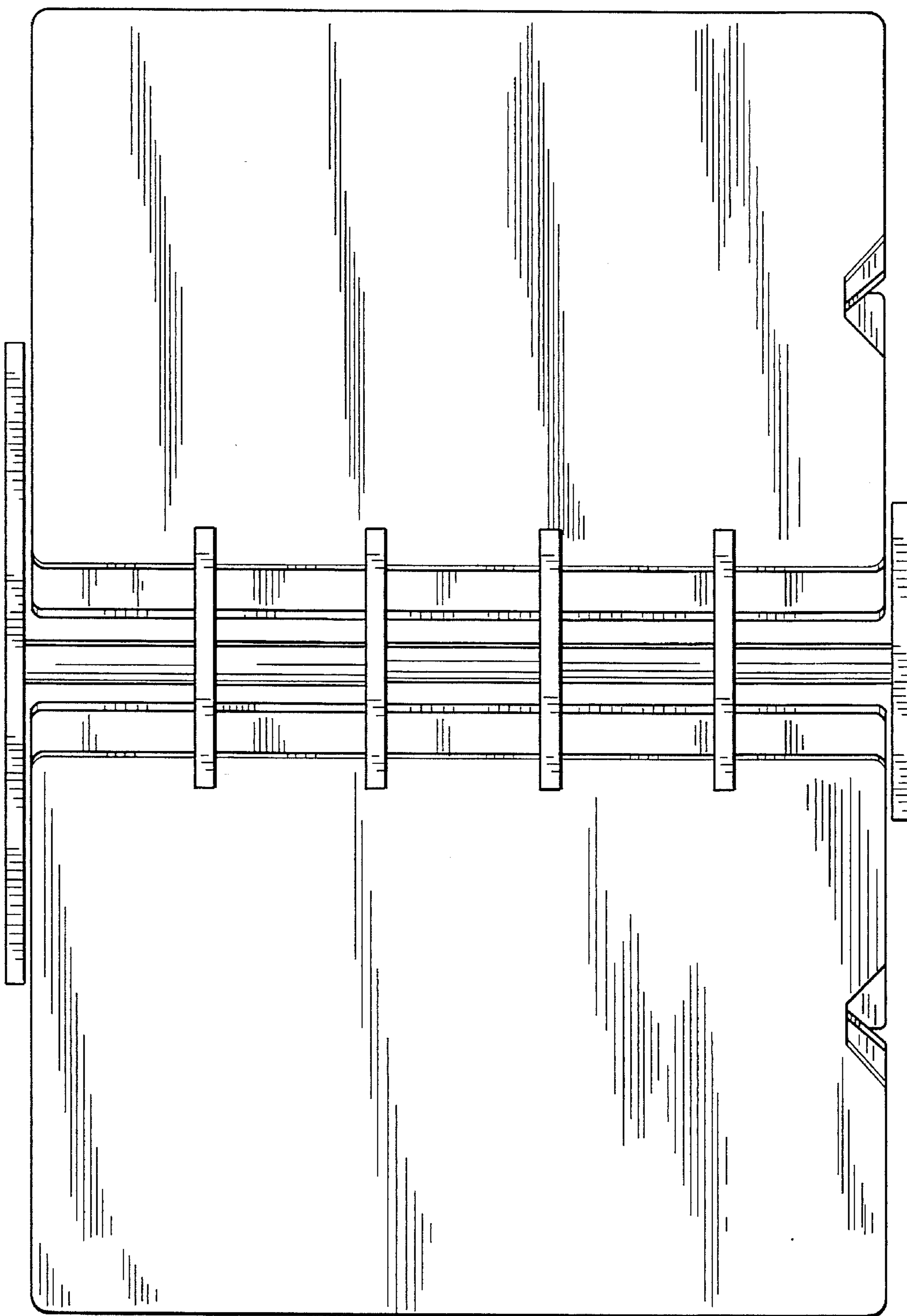
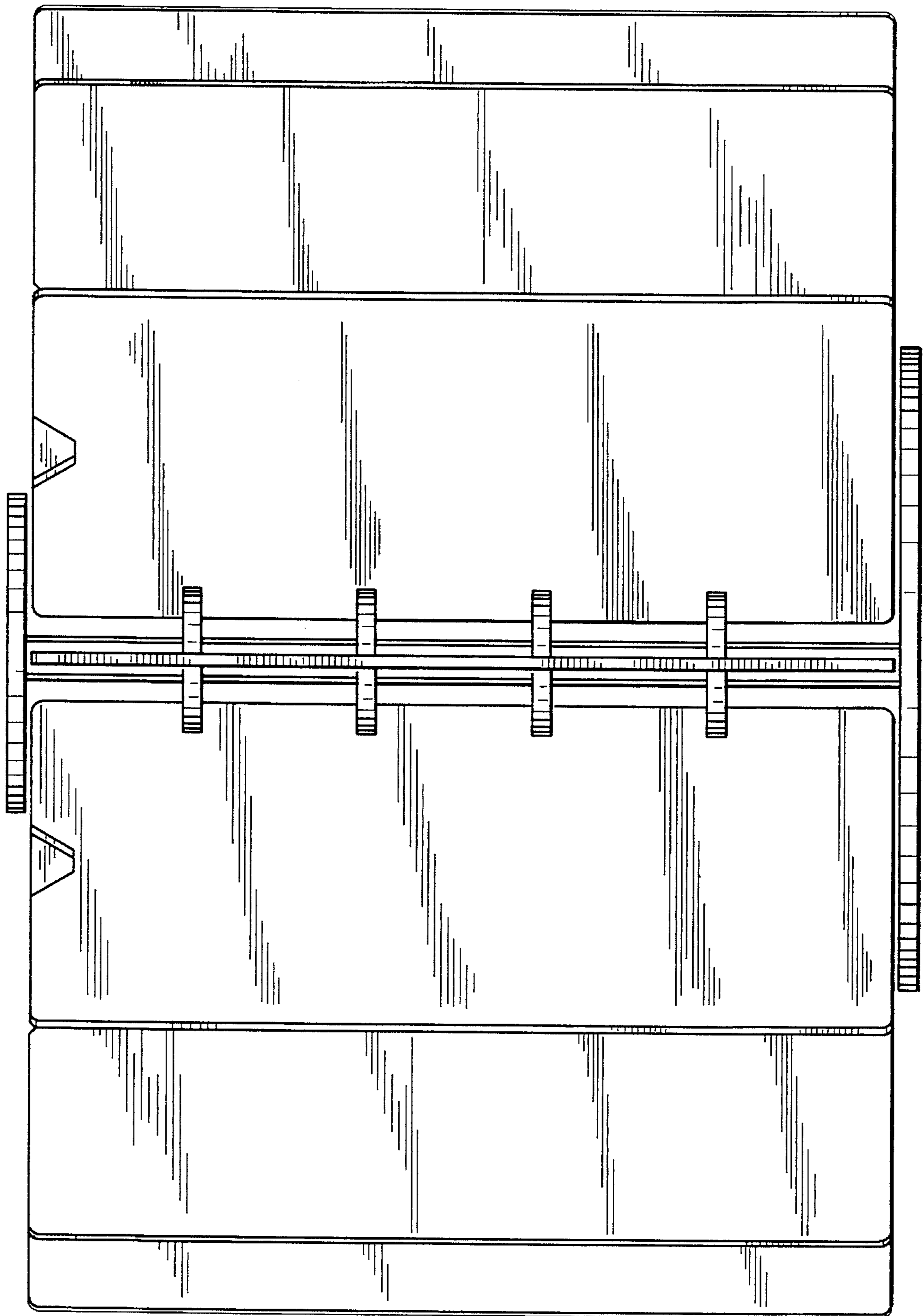

FIG. 12



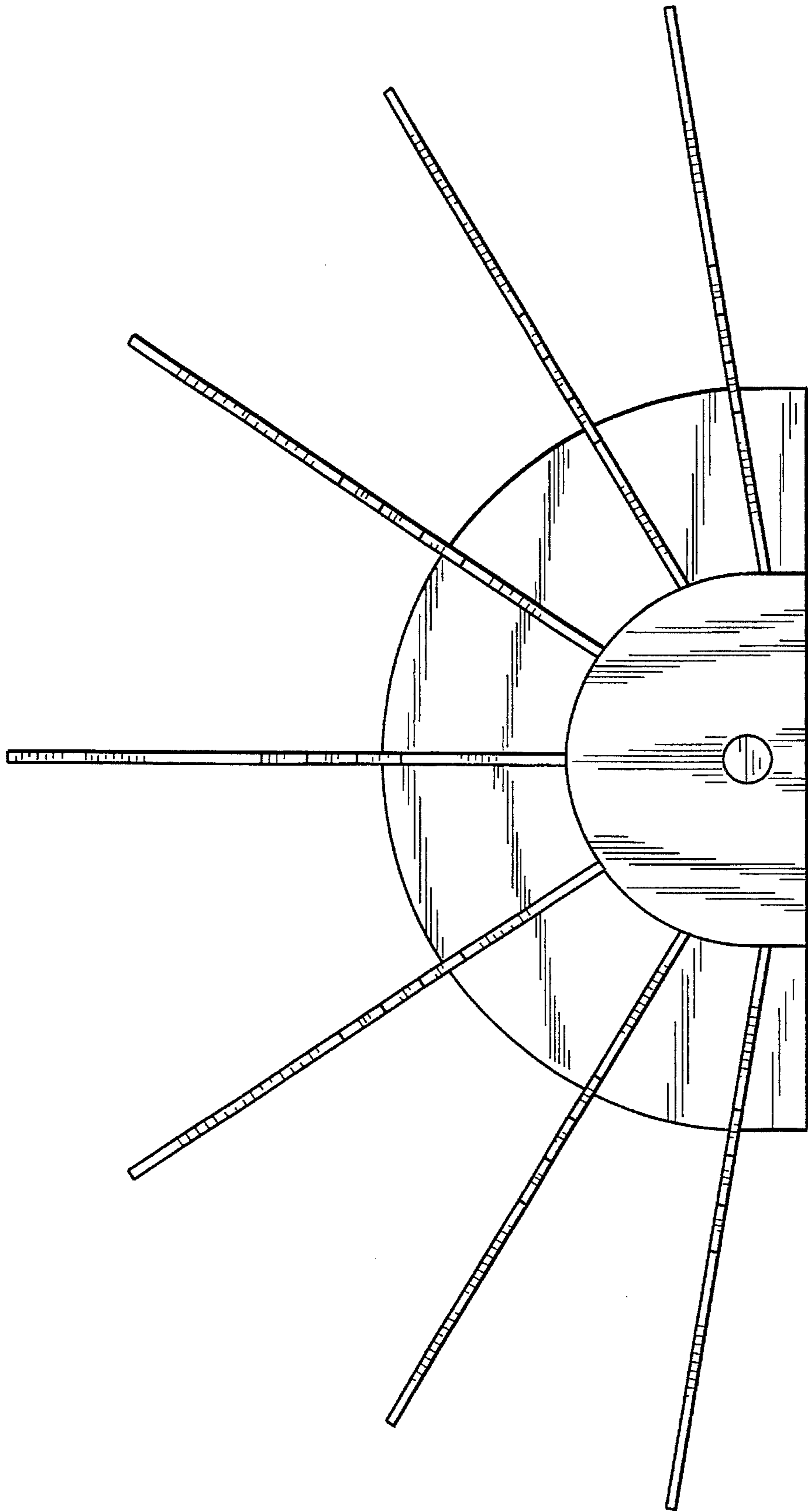

FIG. 13

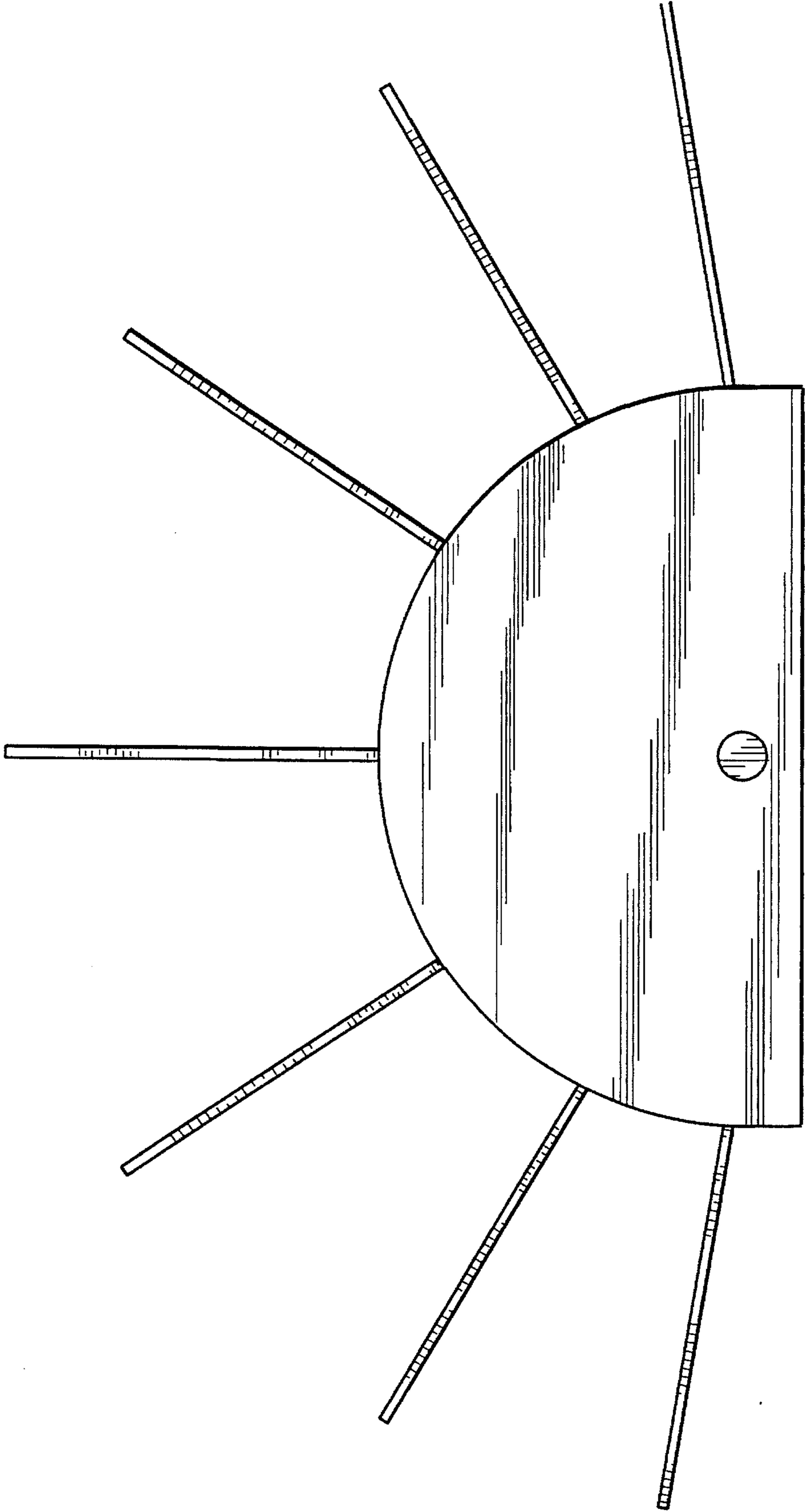

FIG. 14