



US00D369591S

**United States Patent** [19]  
**Kondo**

[11] **Patent Number: Des. 369,591**  
[45] **Date of Patent: \*\*May 7, 1996**

[54] **ELECTRONIC COMPUTER**

685063 8/1986 Japan .

[75] Inventor: **Osamu Kondo**, Tokyo, Japan

(List continued on next page.)

[73] Assignee: **Kabushiki Kaisha Toshiba**, Kawasaki, Japan

**OTHER PUBLICATIONS**

[\*\*] Term: **14 Years**

[21] Appl. No.: **41,920**

[22] Filed: **Jul. 12, 1995**

Brochure "PowerLite", Sun Express, published Feb. 14, 1994.

DENPA SHINBUN, Knowledge Computer, published Apr. 29, 1993.

DENPA SHINBUN, NIHON NCR, published Oct. 27, 1993. Toshiba 1993 two page brochure for the T3400CT Laptop Computer.

NEC PC-9801LV21, May 13, 1963.

NEC PC-9801LX5C, Aug. 23, 1963.

Zenith Data Systems Newsdate, vol. 6, No. 3, Jun.-Jul. 1986.

NEC Multispeed EL, Spring 1988.

REIN Laptop 300 SLC, Oct. 29, 1989.

NEC PC-98LT, Jul. 14, 1988.

Ricoh-Magus, Feb. 1, 1990.

Mitsubishi Maxy, May 15, 1990.

NoteMaster 386S/16, Nov. 12, 1990.

Premium EXEC 386SX120, Jun. 1, 1991.

**Related U.S. Application Data**

[63] Continuation of Ser. No. 26,824, Aug. 4, 1994, abandoned.

[30] **Foreign Application Priority Data**

Mar. 29, 1994 [JP] Japan ..... 6-8236

[52] **U.S. Cl.** ..... **D14/106**

[58] **Field of Search** ..... D14/100, 101, D14/106, 113, 115; D18/1, 7; 235/145 A, 145 R; 341/22, 23; 345/104, 156, 168, 173, 901-905, 87; 361/679-686; 364/708.1, 709.04, 709.12; 400/486, 489

*Primary Examiner*—Freda Nunn

*Attorney, Agent, or Firm*—Banner & Allegretti, Ltd.

[56] **References Cited**

[57] **CLAIM**

**U.S. PATENT DOCUMENTS**

The ornamental design for an electronic computer, as shown and described.

- D. 280,622 9/1995 Moggridge et al. .
- D. 294,029 2/1988 Nishiyama et al. .
- D. 306,285 2/1990 Yu .
- D. 306,433 3/1990 Mitchell .
- D. 308,050 5/1990 Sugano et al. .
- D. 308,860 6/1990 Tsukada et al. .
- D. 308,861 6/1990 Tsukada et al. .
- D. 310,213 8/1990 Tsukada et al. .
- D. 310,828 9/1990 Grundstrom et al. .
- D. 311,527 10/1990 Fujii et al. .

**DESCRIPTION**

(List continued on next page.)

FIG. 1 is a top, front and right side perspective view of an electronic computer showing my new design;  
 FIG. 2 is a front elevational view thereof;  
 FIG. 3 is a top plan view thereof;  
 FIG. 4 is a left side elevational view thereof;  
 FIG. 5 is a right side elevational view thereof;  
 FIG. 6 is a bottom plan view thereof;  
 FIG. 7 is a rear elevational view thereof;  
 FIG. 8 is a front elevational view thereof in the closed position;  
 FIG. 9 is a right side elevational view thereof in the closed position; and,  
 FIG. 10 is a top plan view thereof in the closed position.

**FOREIGN PATENT DOCUMENTS**

- M8800660 10/1988 Germany .
- M8802901 5/1989 Germany .
- M9103696 2/1992 Germany .
- M9309976 7/1994 Germany .
- 685121 8/1986 Japan .

**1 Claim, 5 Drawing Sheets**

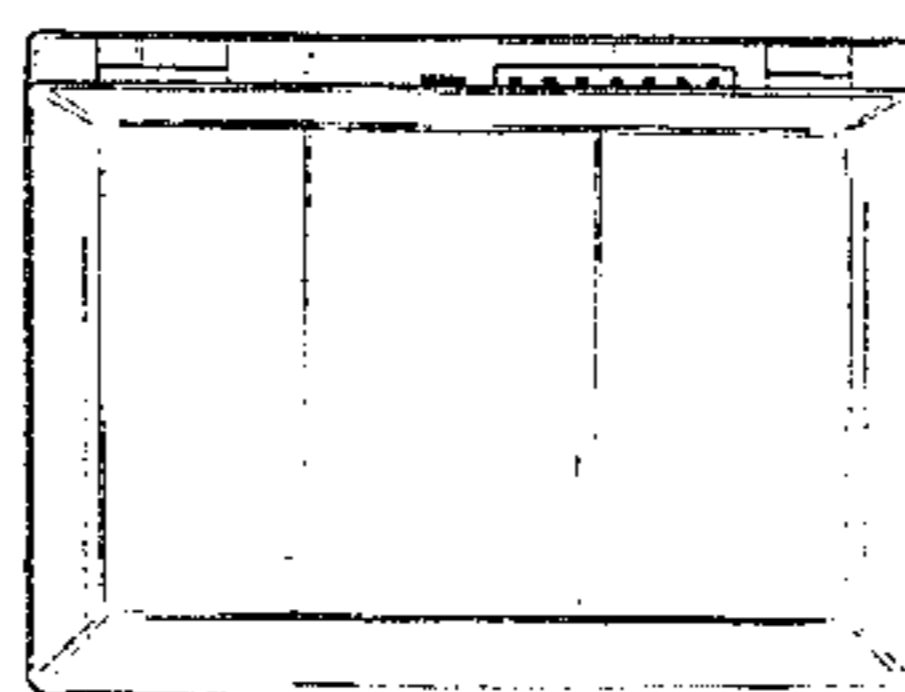

# Des. 369,591

Page 2

## U.S. PATENT DOCUMENTS

D. 312,822 12/1990 Watabe et al. .  
D. 317,442 6/1991 Gintz et al. .  
D. 319,819 9/1991 Kawaguchi .  
D. 321,176 10/1991 Ma .  
D. 324,674 3/1992 Iino .  
D. 328,592 8/1992 Kajita .  
D. 332,783 1/1993 Krakower et al. .... D14/106  
D. 334,558 4/1993 Iino .  
D. 335,126 4/1993 Gelardi et al. .  
D. 335,870 5/1993 Yun .  
D. 336,076 6/1993 Masaaki .  
D. 336,286 6/1993 Iino .  
D. 336,465 6/1993 Kim .  
D. 337,096 7/1993 Iino .  
D. 338,456 8/1993 Brunner et al. .... D14/106  
D. 338,660 8/1993 Youens et al. .  
D. 345,550 3/1994 Iino .  
D. 346,369 4/1994 Iino .  
D. 347,214 5/1994 You-Chi ..... D14/106  
D. 347,829 6/1994 Iino .  
D. 349,106 7/1994 Iino et al. .  
D. 349,278 8/1994 Wetrin ..... D14/106  
D. 350,121 8/1994 Kaneko ..... D14/106

D. 351,377 10/1994 Yu ..... D14/106  
D. 356,069 3/1995 Lee ..... D14/106

## FOREIGN PATENT DOCUMENTS

685000 8/1986 Japan .  
686658 9/1986 Japan .  
685121(1) 10/1988 Japan .  
746985(2) 4/1989 Japan .  
746985(1) 4/1989 Japan .  
763855 6/1989 Japan .  
763840 6/1989 Japan .  
763838 6/1989 Japan .  
761927 5/1990 Japan .  
67297 2/1987 Rep. of Korea .  
113906 5/1991 Rep. of Korea .  
115245(1) 6/1991 Rep. of Korea .  
115245 6/1991 Rep. of Korea .  
115787 7/1991 Rep. of Korea .  
115780 7/1991 Rep. of Korea .  
115673 7/1991 Rep. of Korea .  
118263 9/1991 Rep. of Korea .  
122562 1/1992 Rep. of Korea .  
123194 2/1992 Rep. of Korea .  
115673(1) 5/1992 Rep. of Korea .  
105573 11/1987 Taiwan .

FIG. 1



FIG. 2

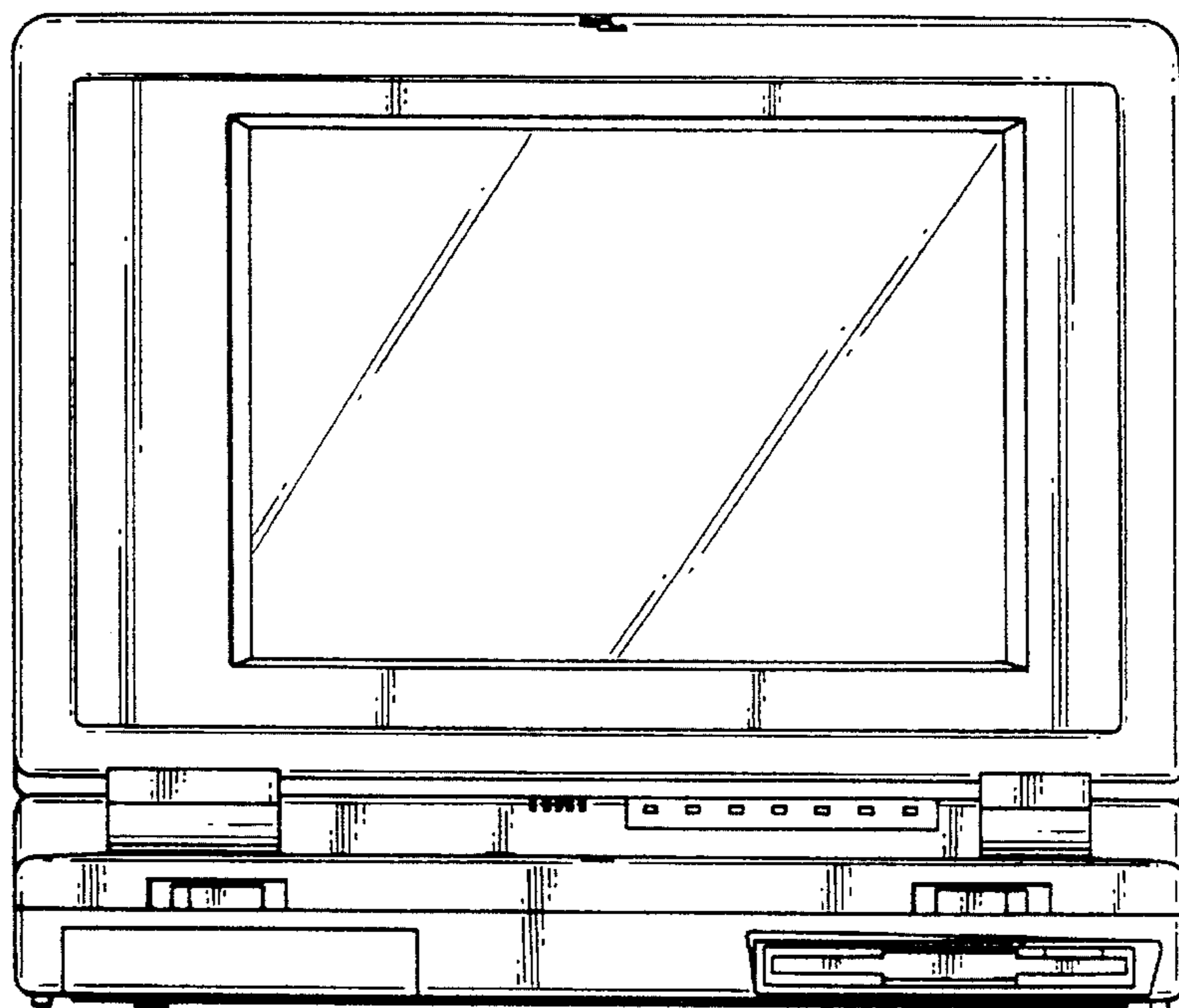

FIG.3

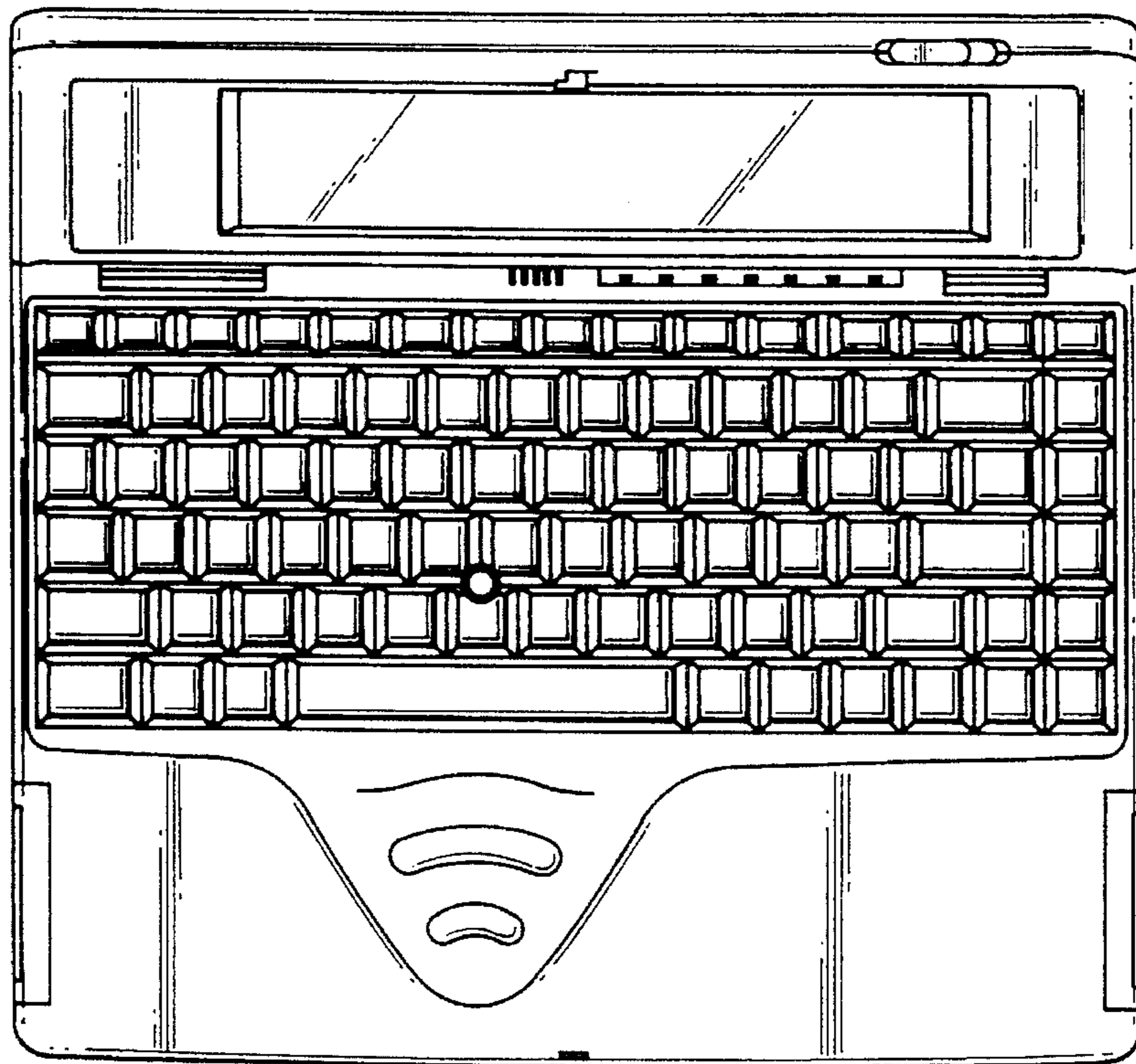

FIG.4

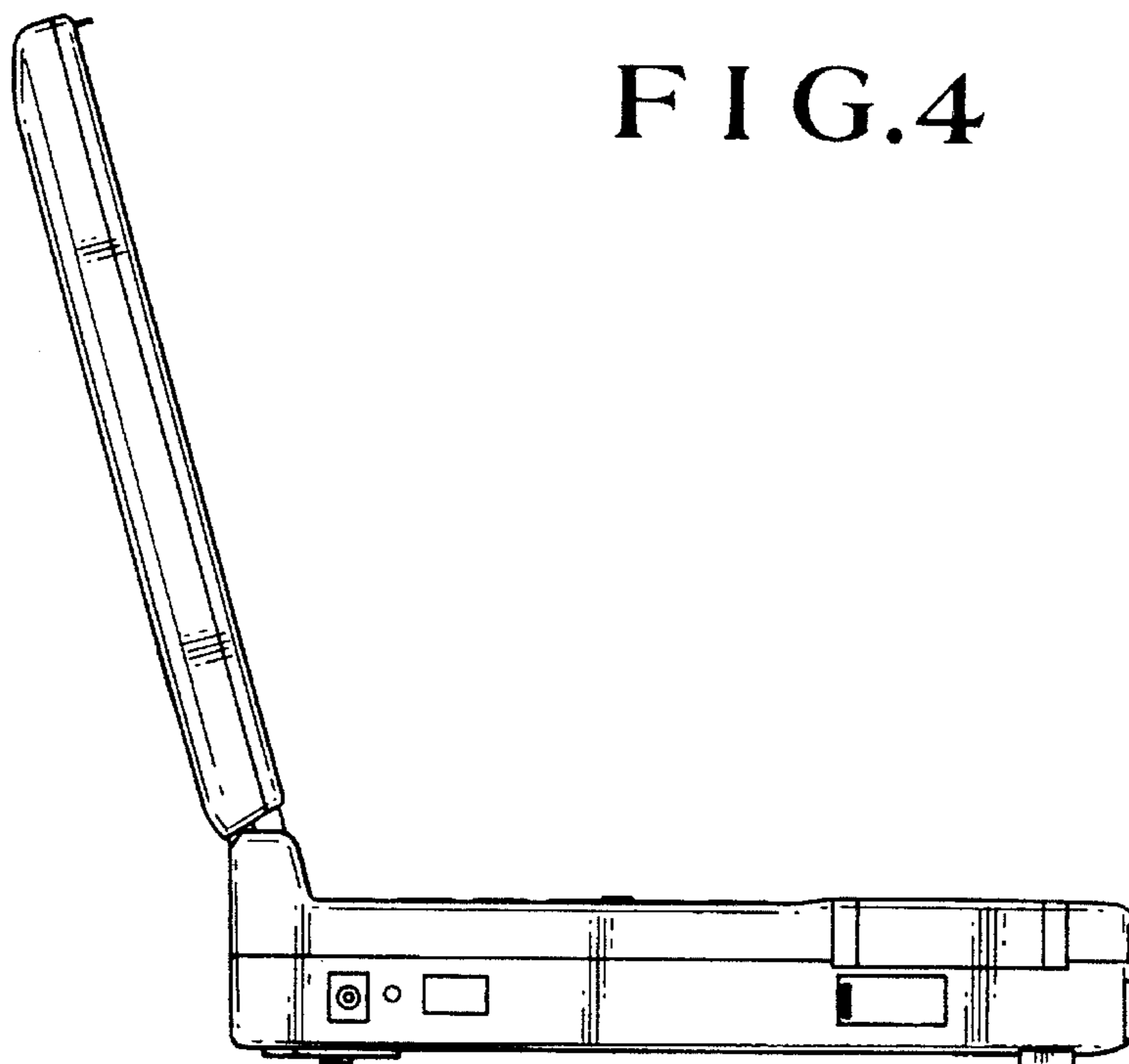

FIG.5

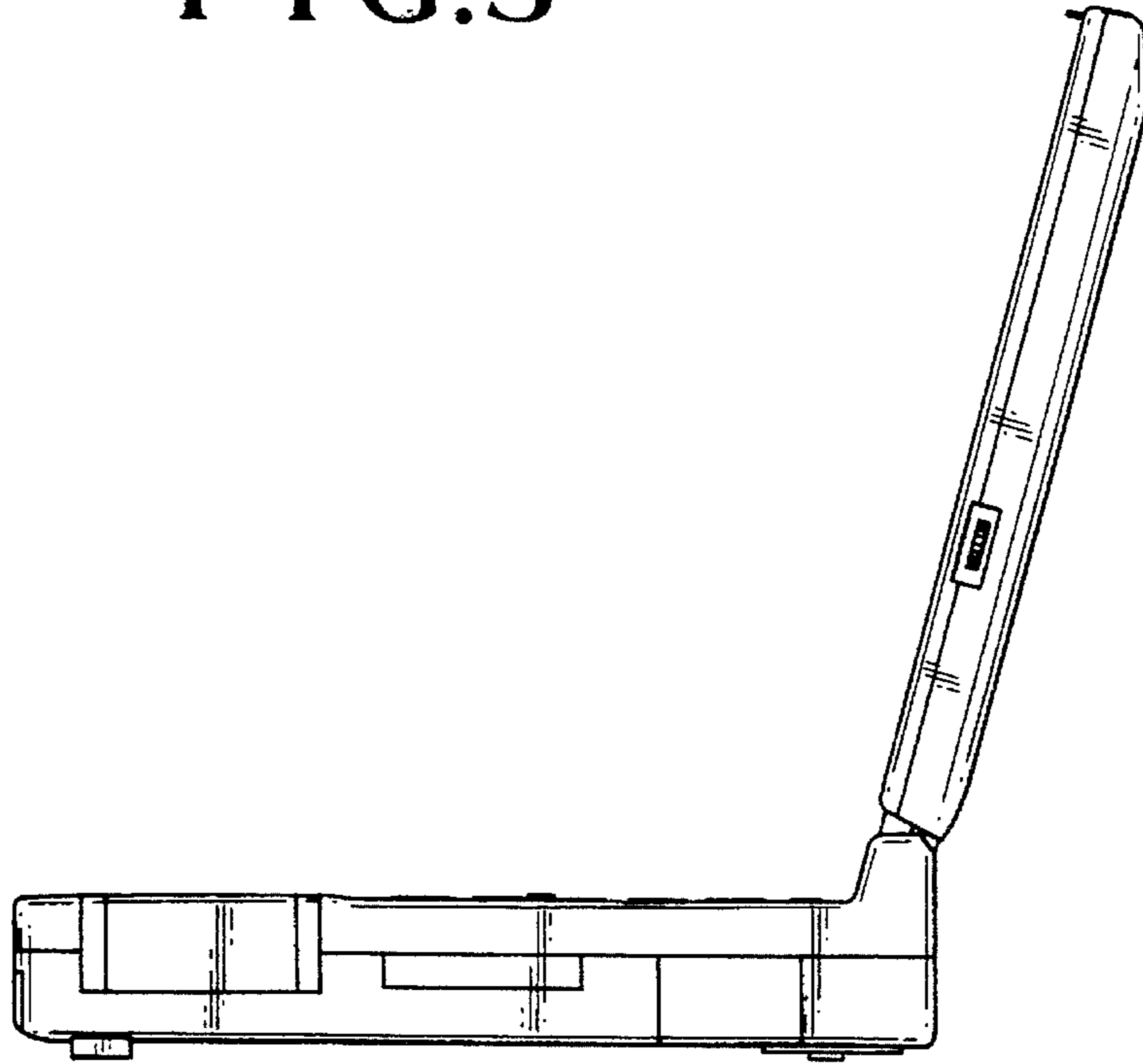

FIG.6

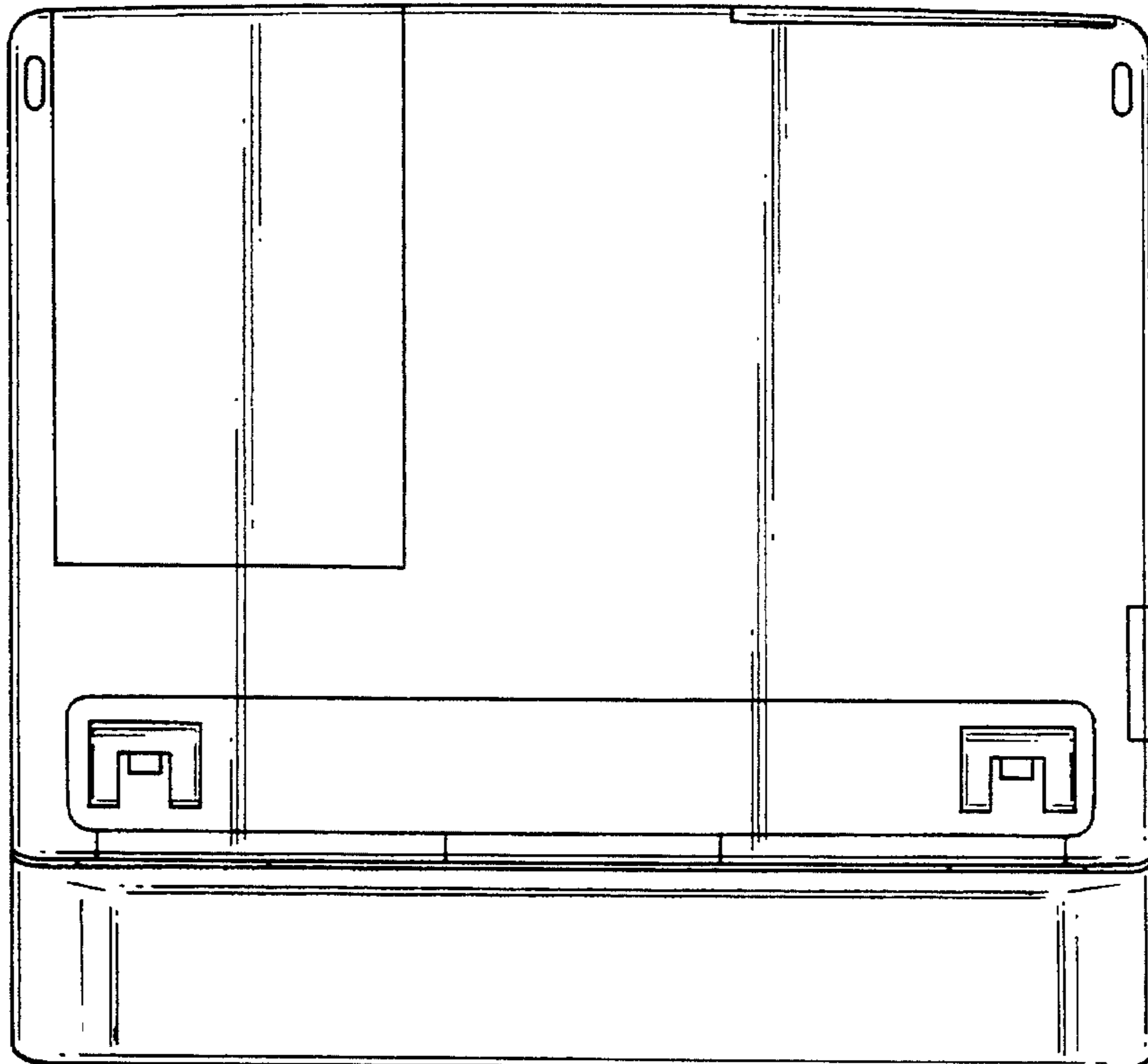

FIG. 7

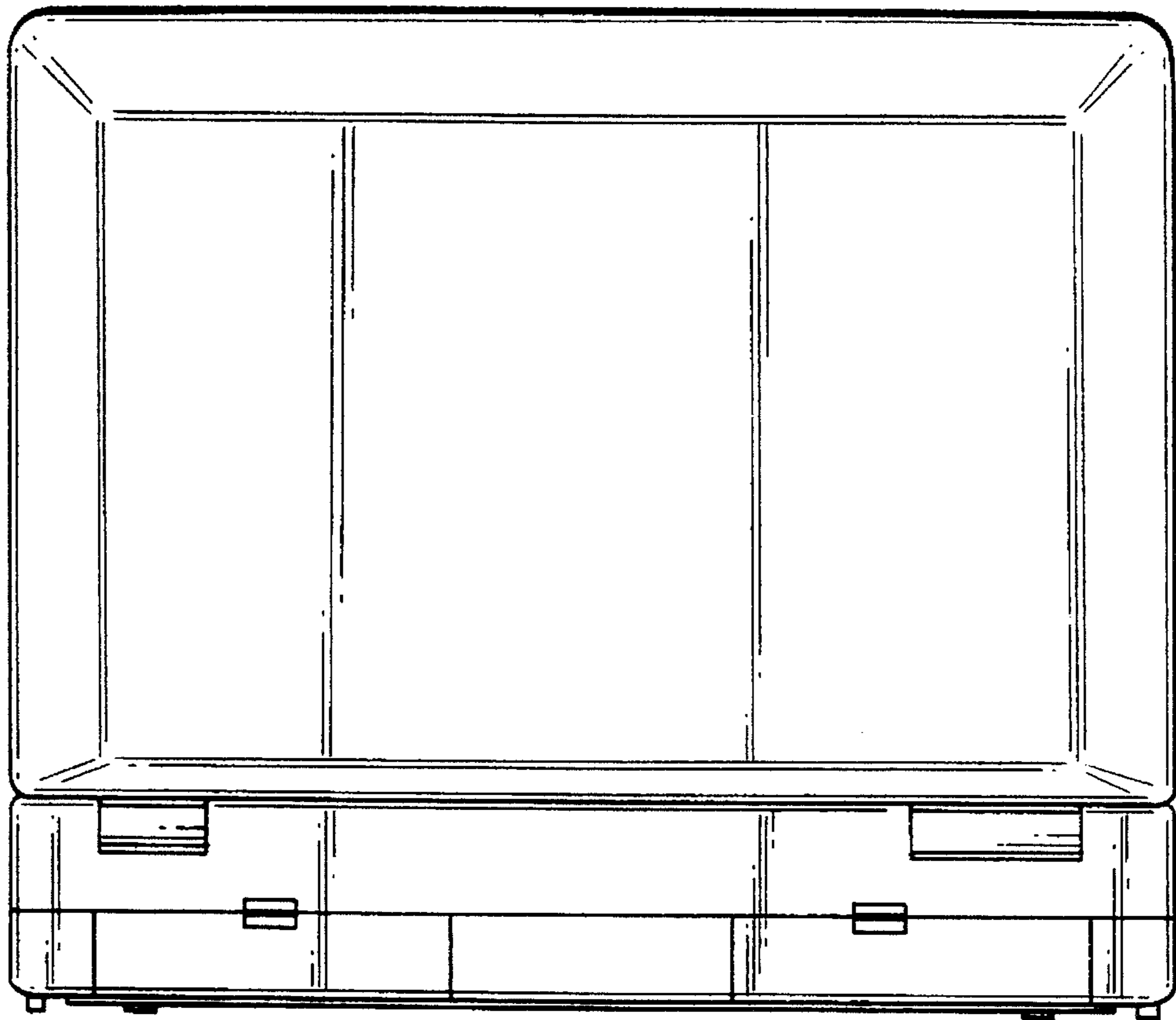
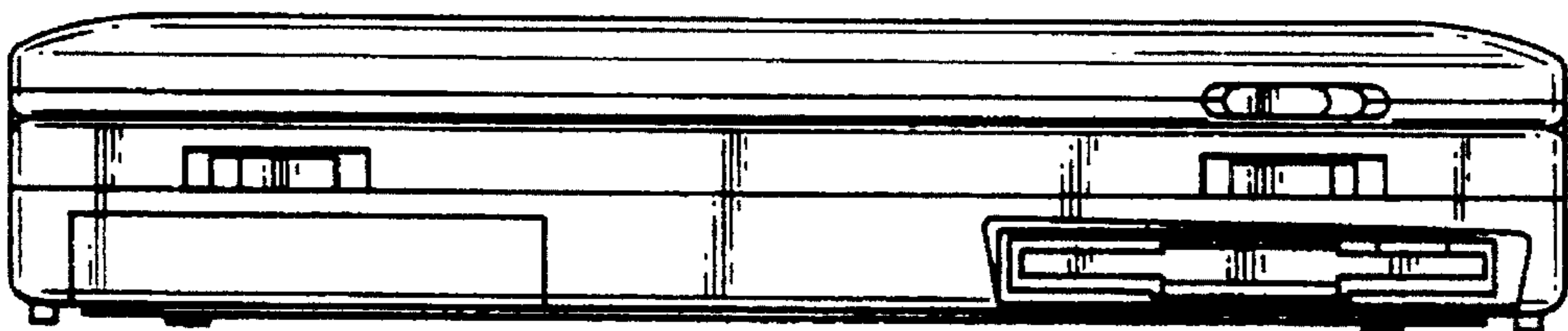
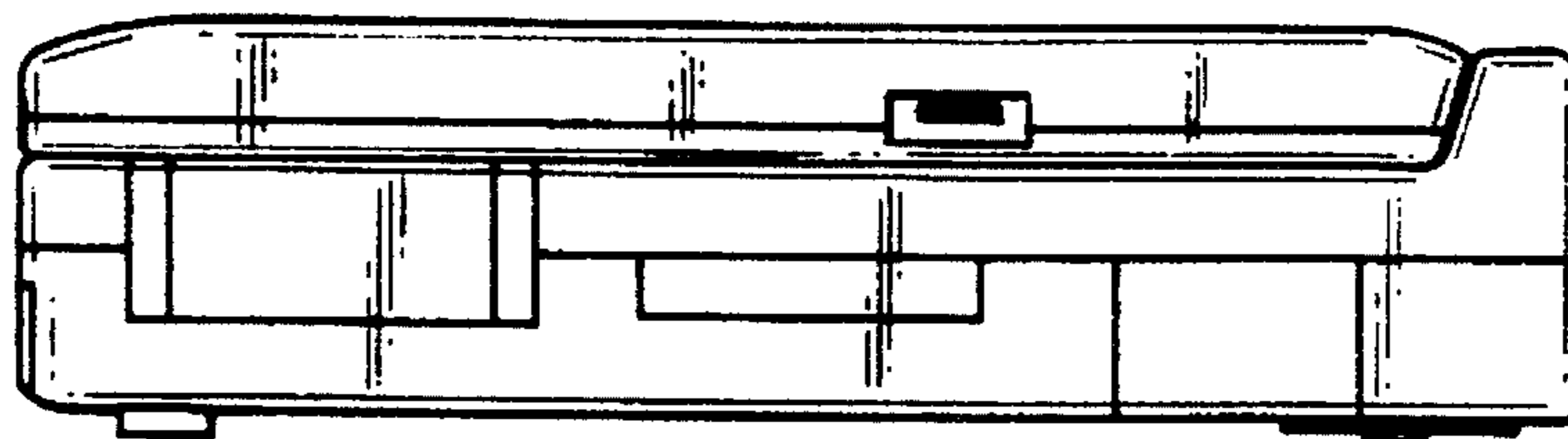

FIG. 8



**FIG.9**



**FIG.10**

