



US00D369446S

United States Patent [19] Smith

[11] Patent Number: **Des. 369,446**

[45] Date of Patent: ****Apr. 30, 1996**

[54] **FLOOR SCRUBBER**

5,279,672 1/1994 Betker et al. 134/18
5,383,251 1/1995 Whitaker et al. 15/320

[75] Inventor: **Barry W. Smith**, Dublin, Ohio

[73] Assignee: **White Consolidated Industries, Inc.**,
Cleveland, Ohio

[**] Term: **14 Years**

Primary Examiner—Alan P. Douglas
Assistant Examiner—Stacia Sinuik
Attorney, Agent, or Firm—Pearne, Gordon, McCoy &
Granger

[21] Appl. No.: **29,936**

[22] Filed: **Oct. 19, 1994**

[52] U.S. Cl. **D32/19**

[58] Field of Search D32/1, 19; 15/320-321,
15/352-353, 328, 330; 134/18

[57] CLAIM

The ornamental design for a floor scrubber, as shown and described.

DESCRIPTION

FIG. 1 is a perspective view of a floor scrubber, showing my new design;

FIG. 2 is a left side elevational view thereof;

FIG. 3 is a right side elevational view thereof;

FIG. 4 is a top plan view thereof;

FIG. 5 is a bottom plan view thereof;

FIG. 6 is a front end view thereof; and,

FIG. 7 is a rear end view thereof.

[56] References Cited

U.S. PATENT DOCUMENTS

D. 333,018	2/1993	Bothun et al.	D32/19
3,376,597	4/1968	Boyd	15/320
4,483,041	11/1984	Waldhauser et al.	15/359
4,759,094	7/1988	Palmer et al.	15/320
5,093,955	3/1992	Blehert et al.	15/320

1 Claim, 6 Drawing Sheets

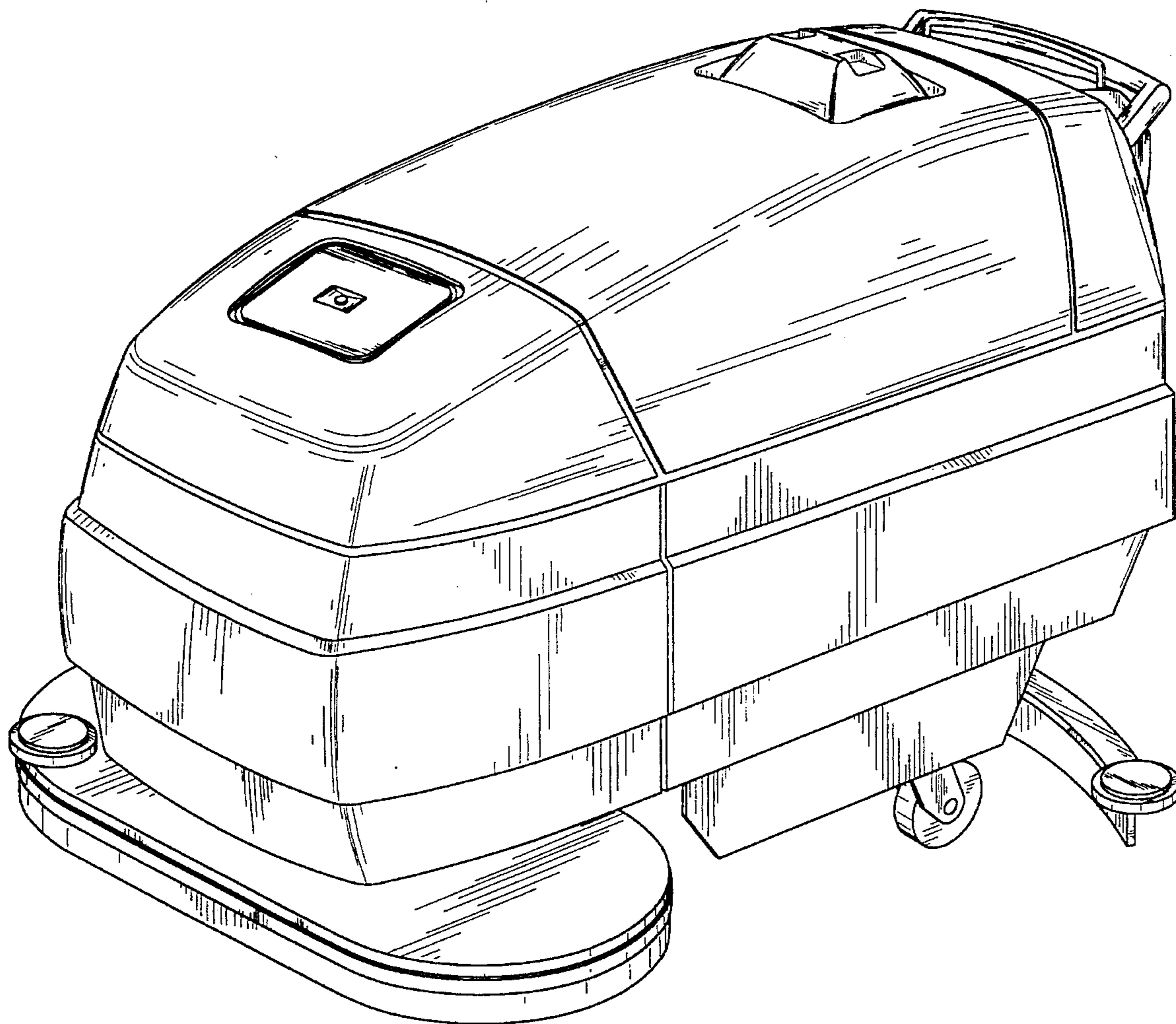

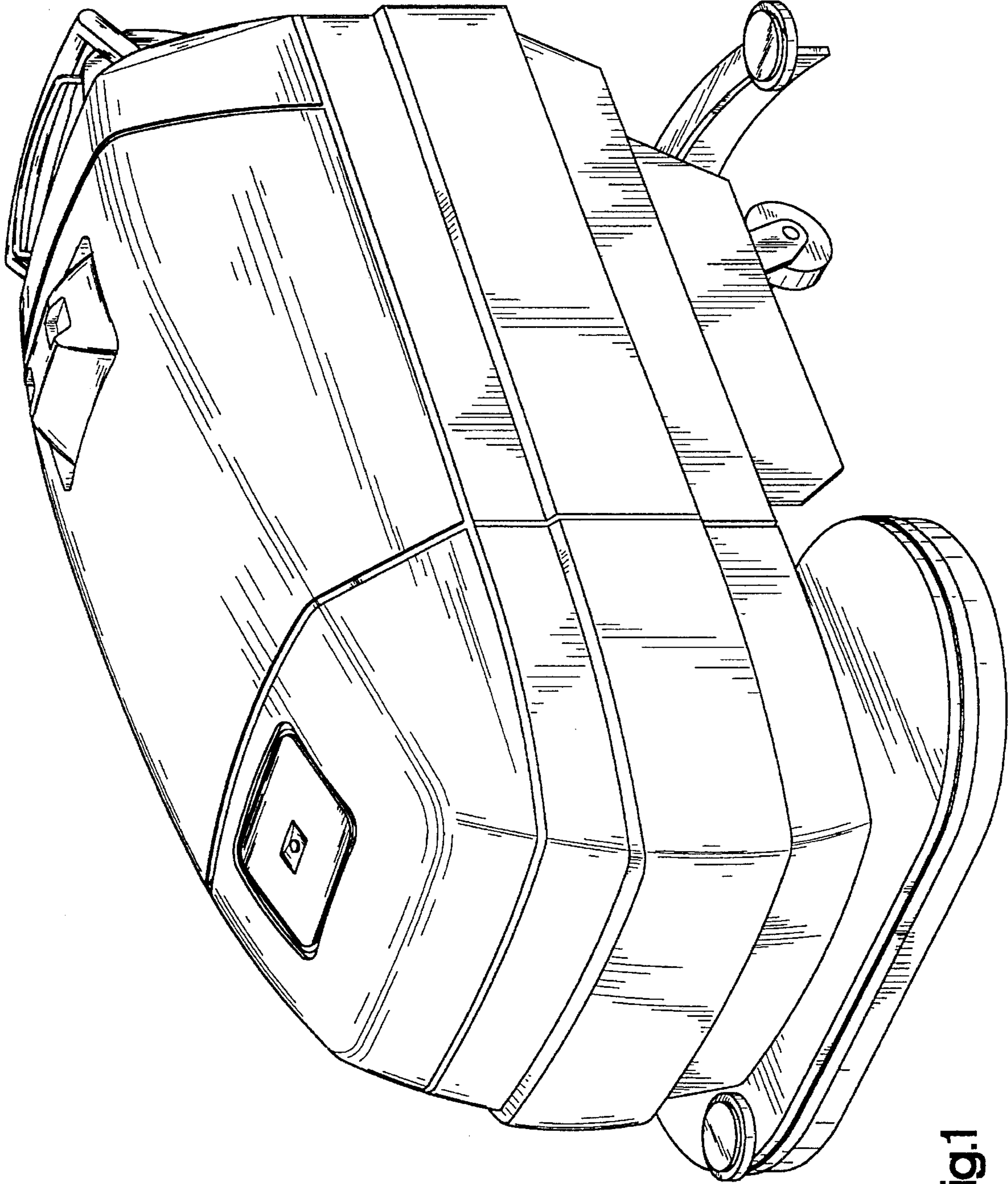

Fig.1

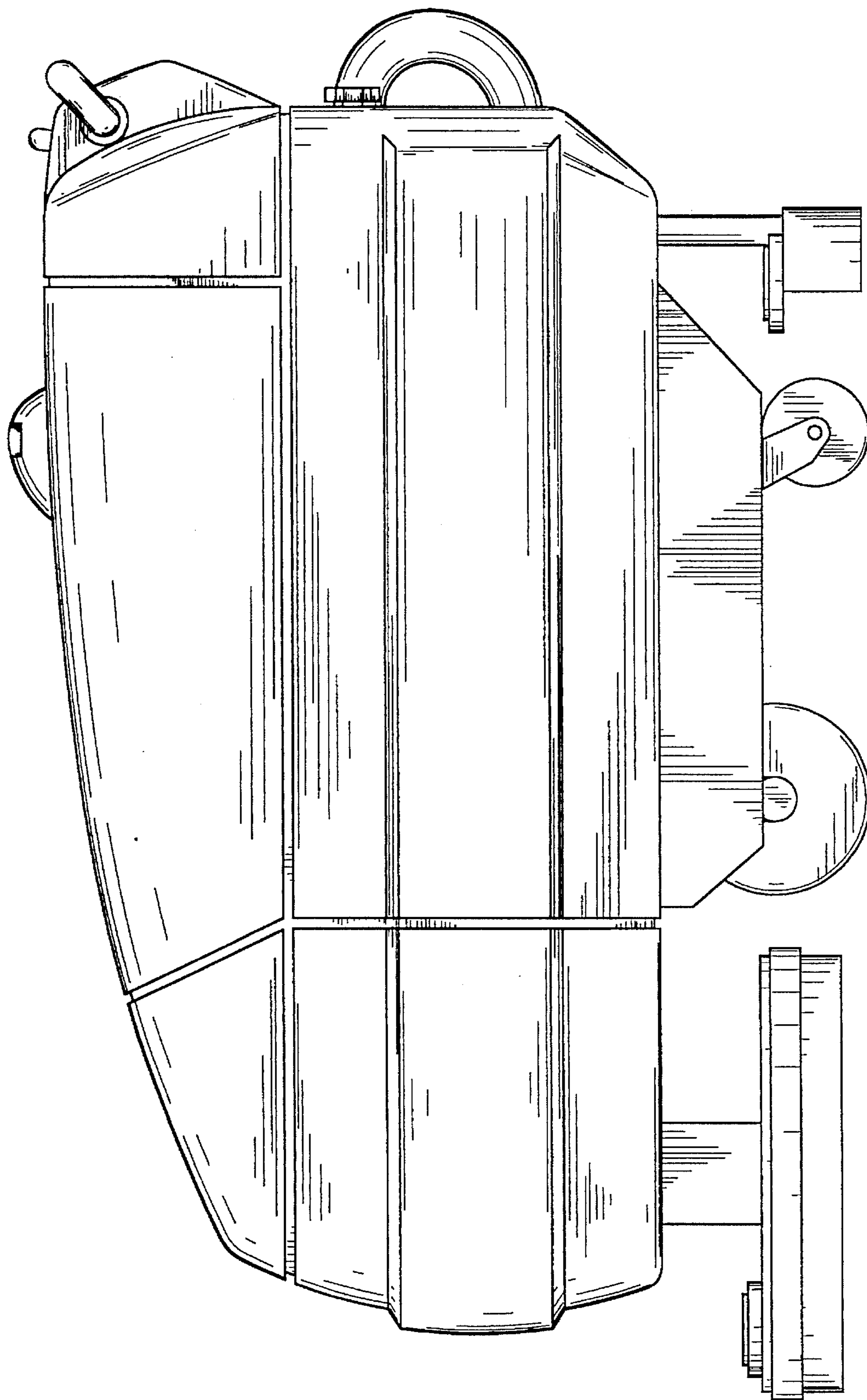

Fig.2

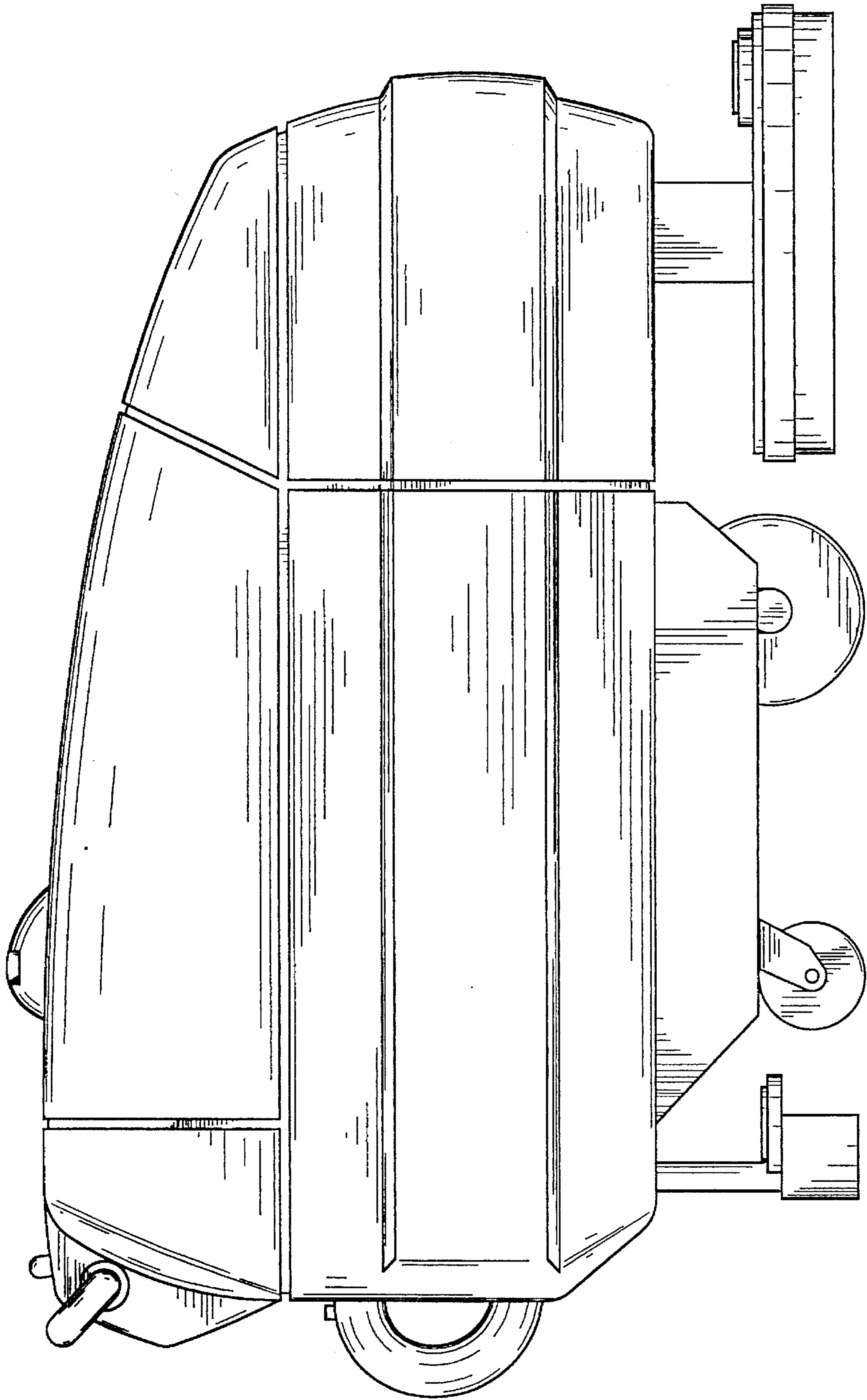

Fig.3

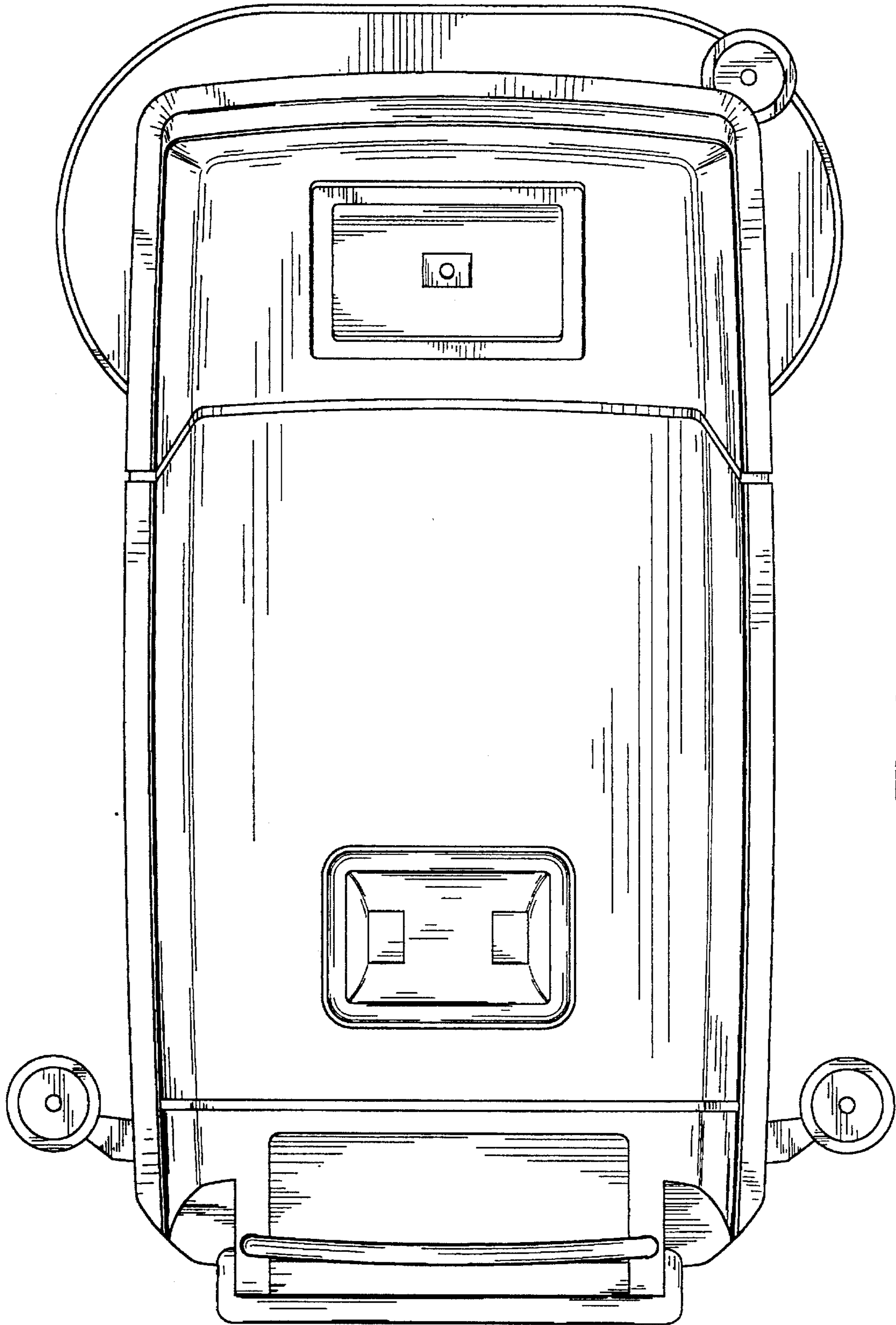

Fig.4

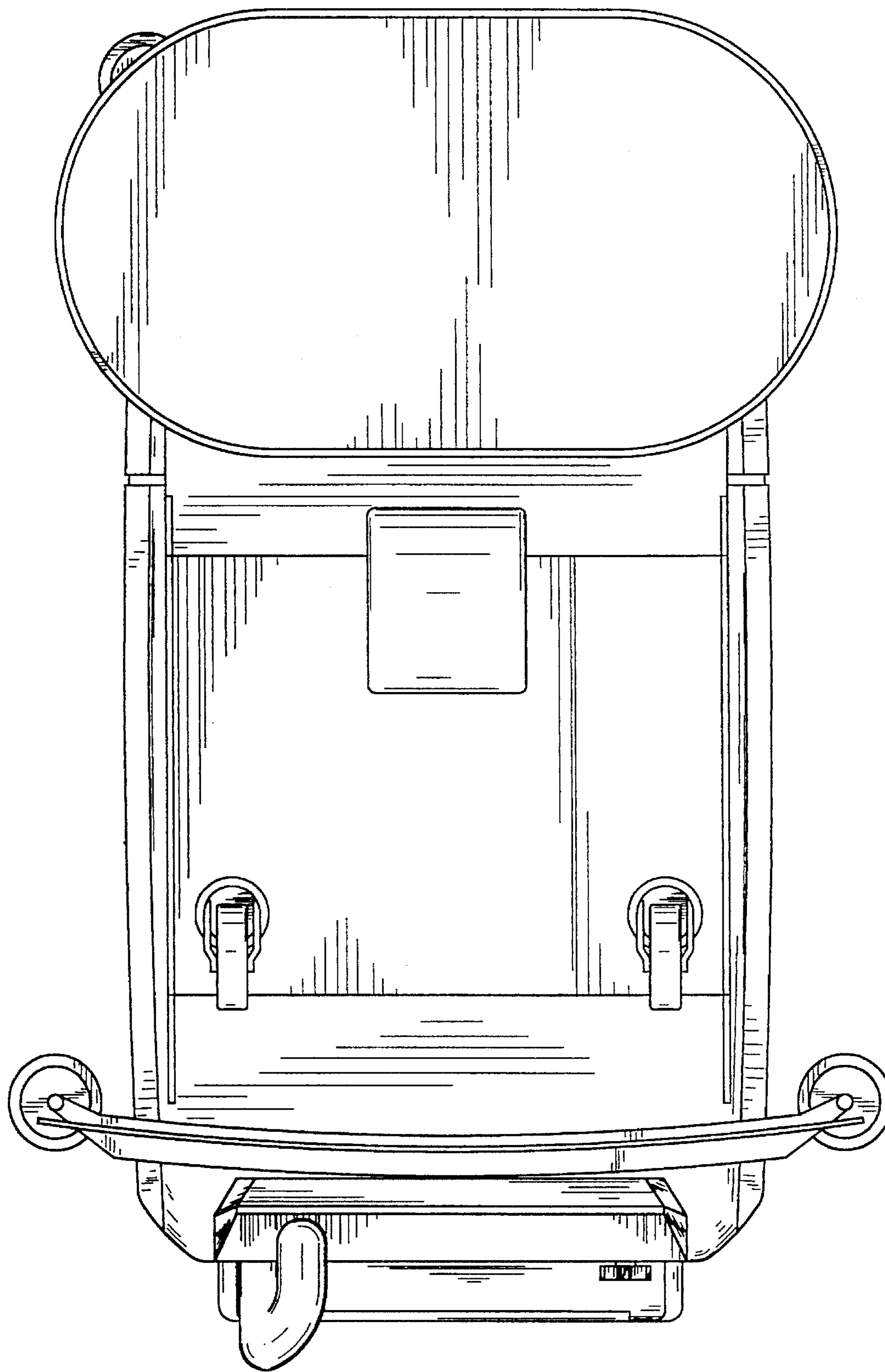

Fig.5

Fig.6

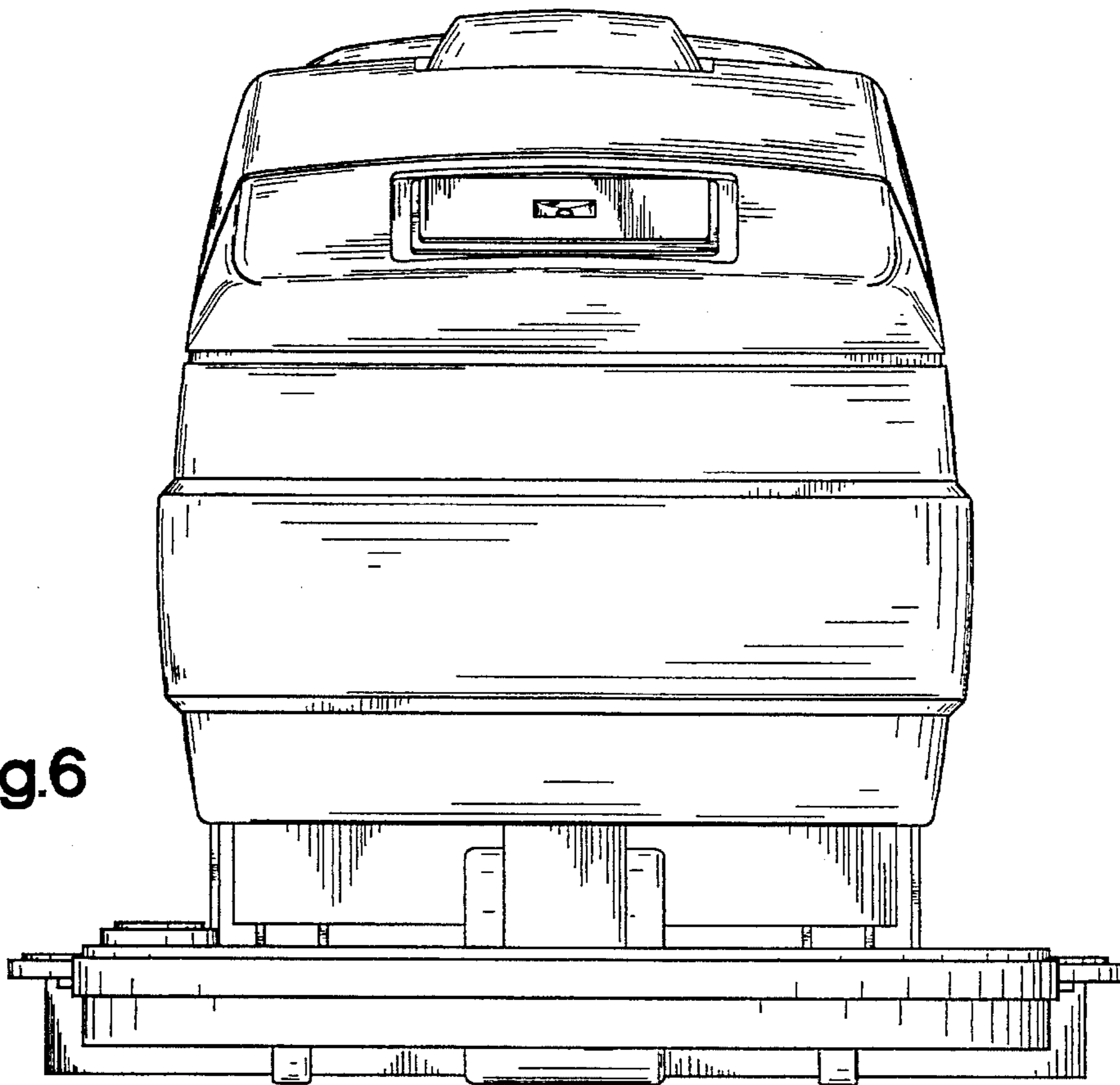

Fig.7

