



US00D369400S

# United States Patent [19]

[11] Patent Number: **Des. 369,400**

**Kawamura et al.**

[45] Date of Patent: **\*\*Apr. 30, 1996**

[54] **COMBINED TOILET BASIN, TOILET SEAT AND SEAT COVER**

- D. 288,588 3/1987 Stairs, Jr. .
- D. 288,589 3/1987 Stairs, Jr. .
- D. 288,590 3/1987 Stairs, Jr. .
- D. 311,435 10/1990 Cheng ..... D23/301
- D. 342,778 12/1993 Chen ..... D23/301
- D. 343,892 2/1994 Chen ..... D23/301
- D. 347,496 5/1994 Wei ..... D23/301

[76] Inventors: **Seijiro Kawamura; Noriko Y. Hashida**, c/o Toto, Ltd., 1-1 Nakashima 2-chome, Kokurakita-ku, Kitakyushu City, Fukuoka, Japan

[\*\*] Term: **14 Years**

*Primary Examiner*—Stella Reid  
*Assistant Examiner*—Eric Watterson

[21] Appl. No.: **25,034**

[57] **CLAIM**

[22] Filed: **Jun. 27, 1994**

The ornamental design for a combined toilet basin, toilet seat and seat cover, as shown and described.

### Related U.S. Application Data

[63] Continuation-in-part of Ser. No. 1,004, Oct. 30, 1992, Pat. No. Des. 354,121.

### DESCRIPTION

### [30] Foreign Application Priority Data

Dec. 28, 1993	[JP]	Japan	.....	5-39883
Dec. 28, 1993	[JP]	Japan	.....	5-39884
Dec. 28, 1993	[JP]	Japan	.....	5-39885
Dec. 28, 1993	[JP]	Japan	.....	5-39886
Dec. 28, 1993	[JP]	Japan	.....	5-39887
Dec. 28, 1993	[JP]	Japan	.....	5-39888

FIG. 1 is a right side elevational view of a combined toilet basin, toilet seat and seat cover embodying our design;  
 FIG. 2 is a rear elevational view;  
 FIG. 3 is a front elevational view;  
 FIG. 4 is a top plan view;  
 FIG. 5 is a bottom plan view;  
 FIG. 6 is a perspective view of the front and right side thereof;  
 FIG. 7 is a right elevational view of a second embodiment of a toilet basin, toilet seat and seat cover assembly embodying our design;  
 FIG. 8 is a rear elevational view thereof;  
 FIG. 9 is a front elevational view thereof;  
 FIG. 10 is a top plan view thereof;  
 FIG. 11 is a bottom plan view thereof; and,  
 FIG. 12 is a perspective view of the front and right side thereof.

[52] U.S. Cl. .... **D23/295**  
[58] Field of Search ..... D23/295-301;  
4/420.1-420.5, 443-448

### [56] References Cited

#### U.S. PATENT DOCUMENTS

D. 250,202	11/1978	Doman et al.	.....	D23/301
D. 268,779	4/1983	Doman .		
D. 275,515	9/1984	Kaiser .		
D. 275,599	9/1984	Enthoven .		

**1 Claim, 4 Drawing Sheets**

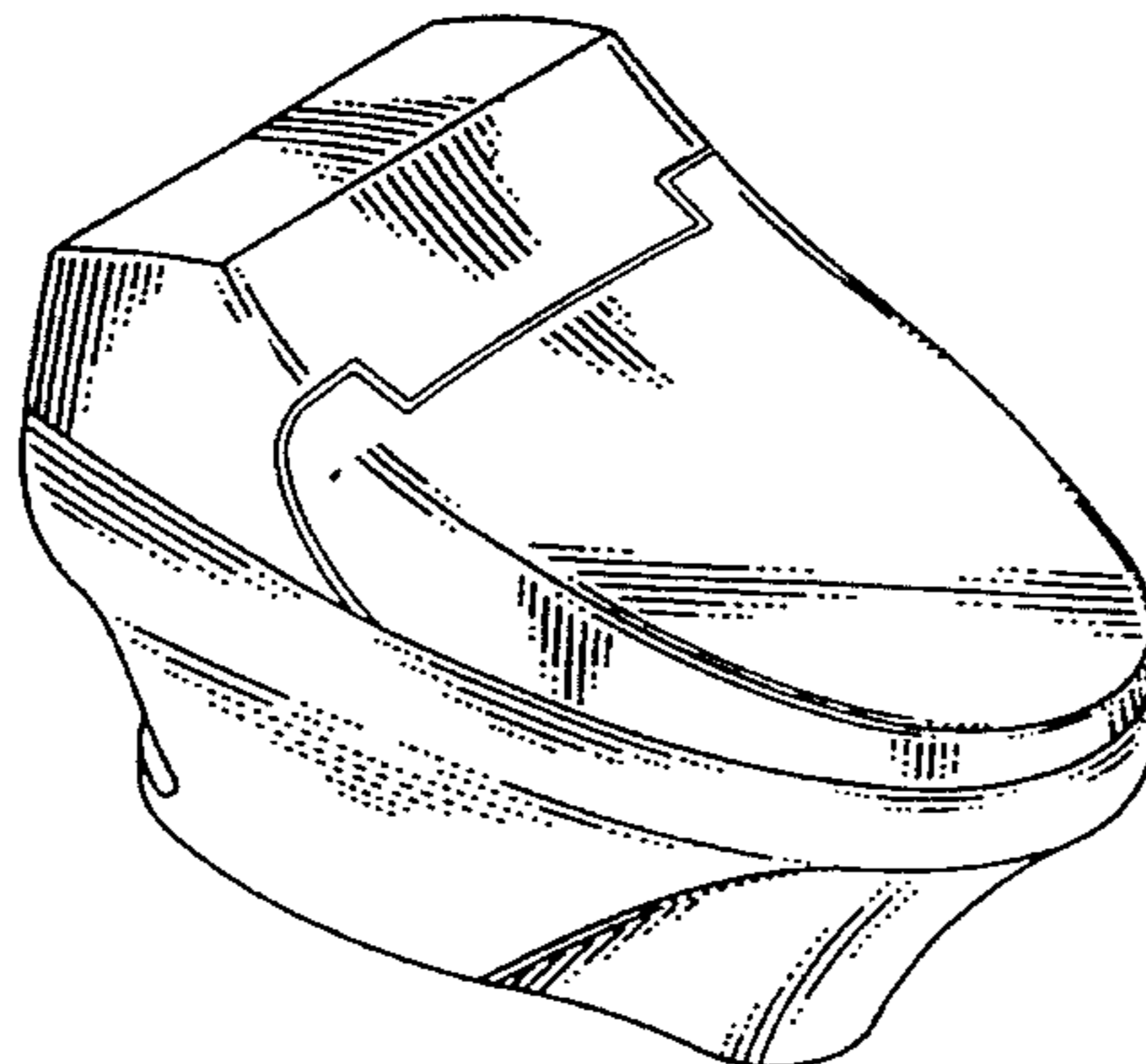
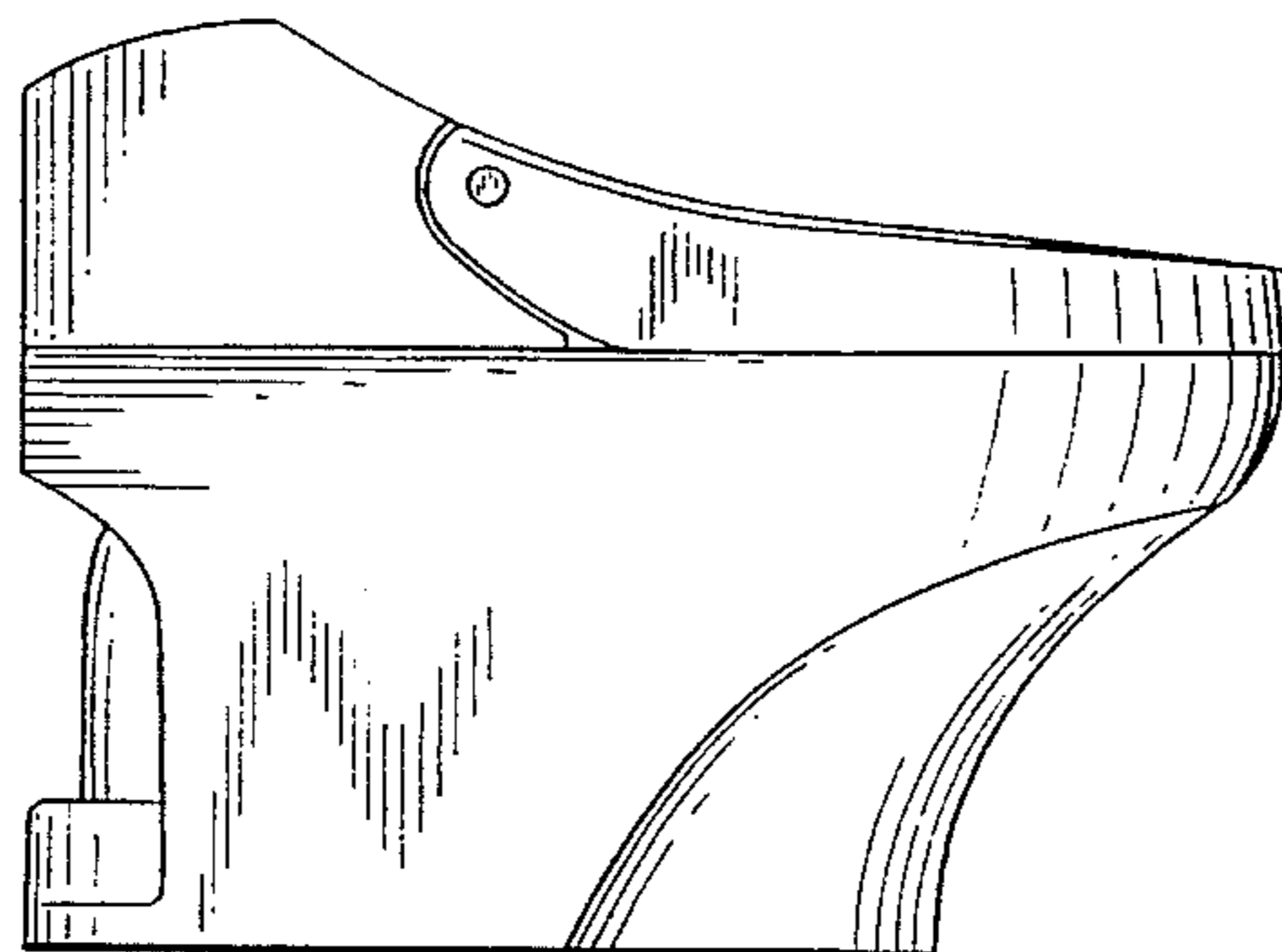

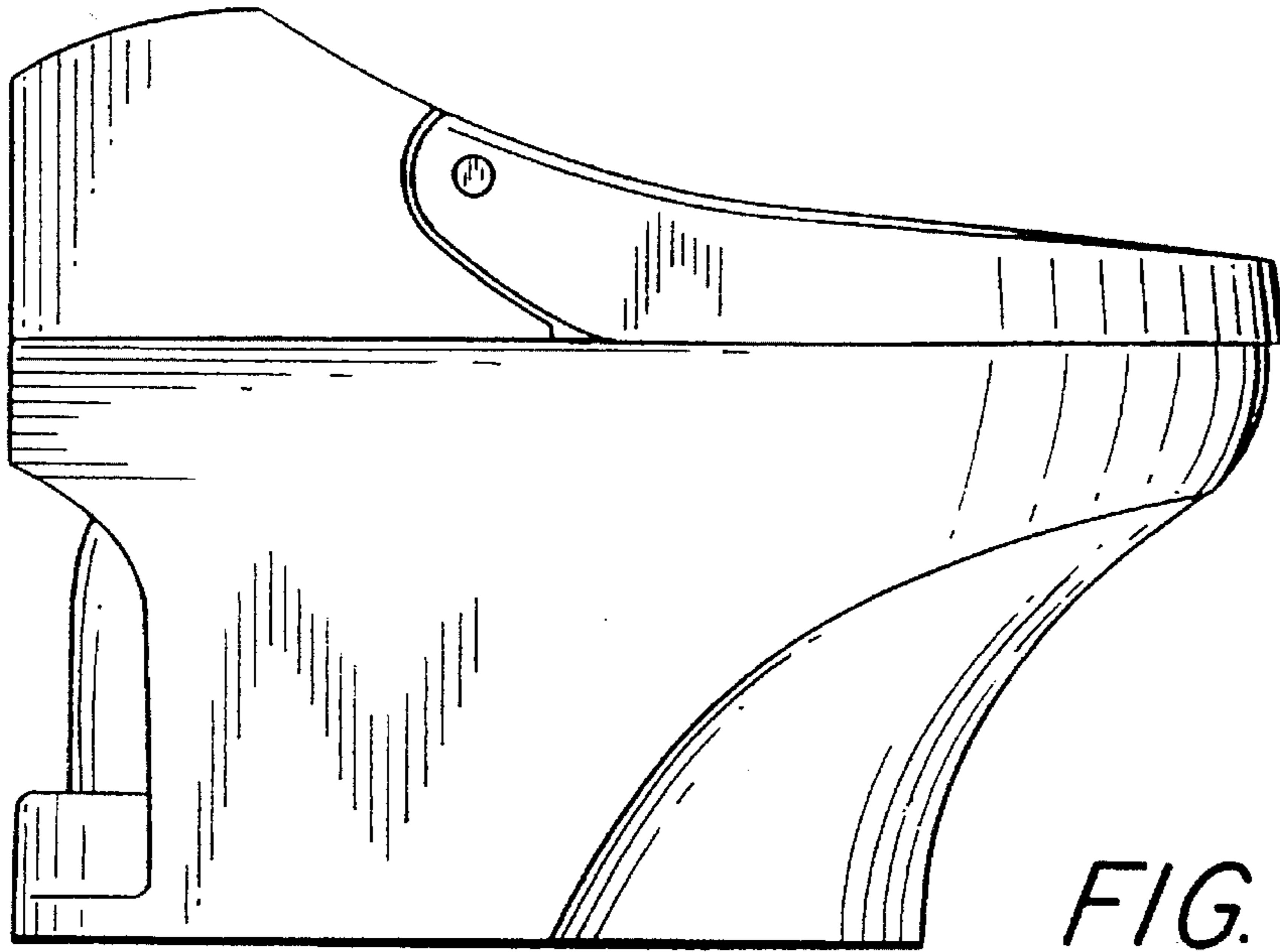

FIG. 1

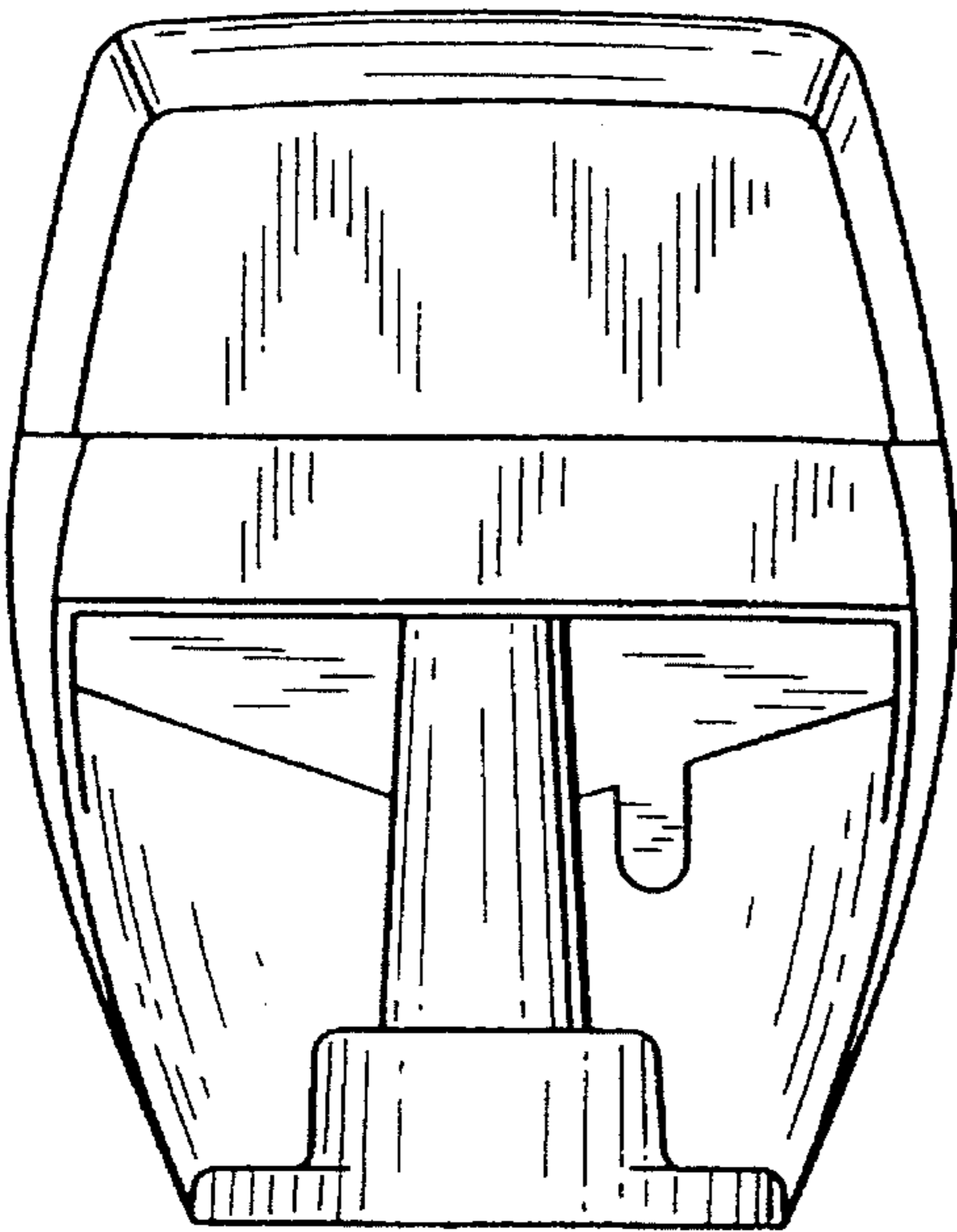

FIG. 2

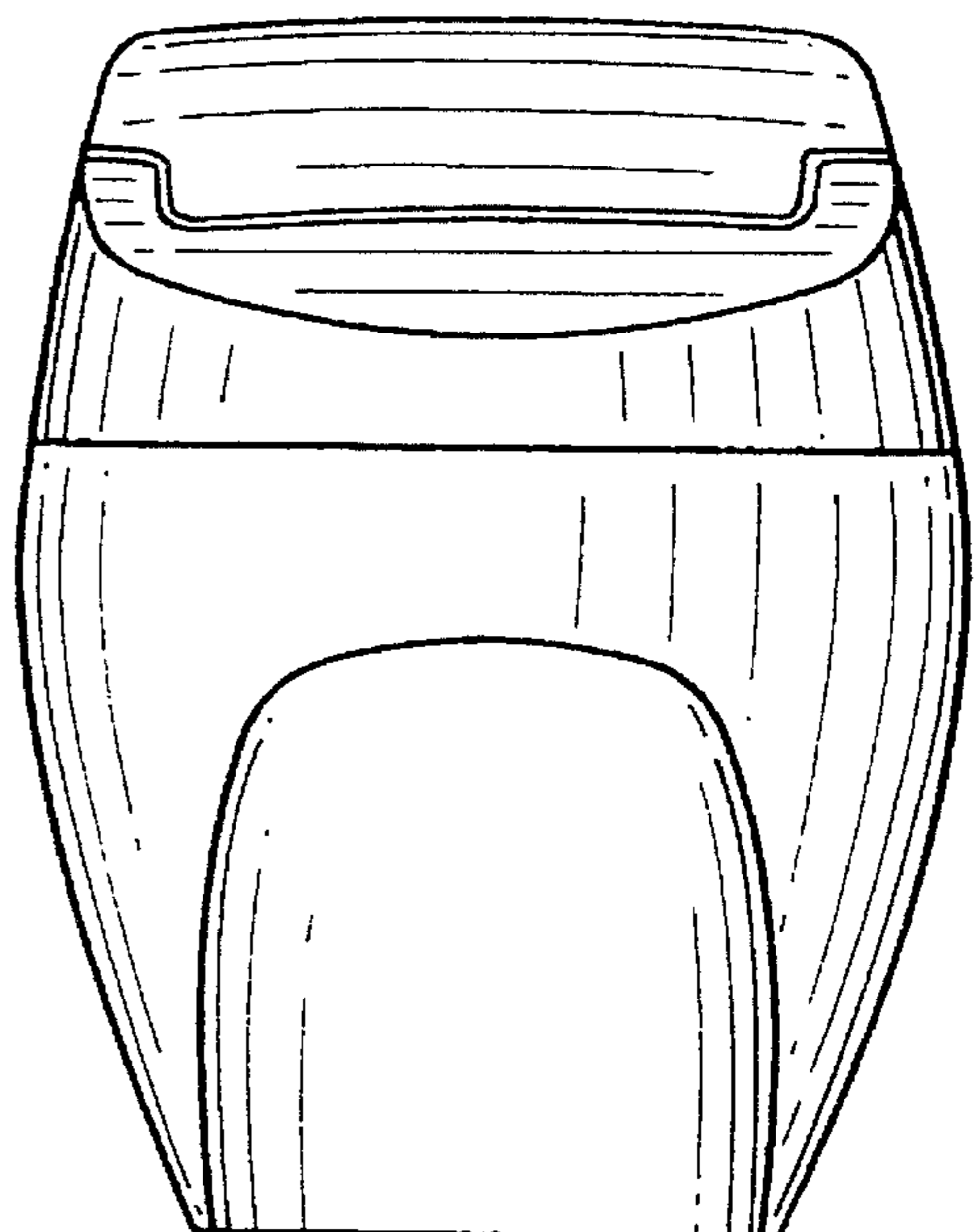

FIG. 3

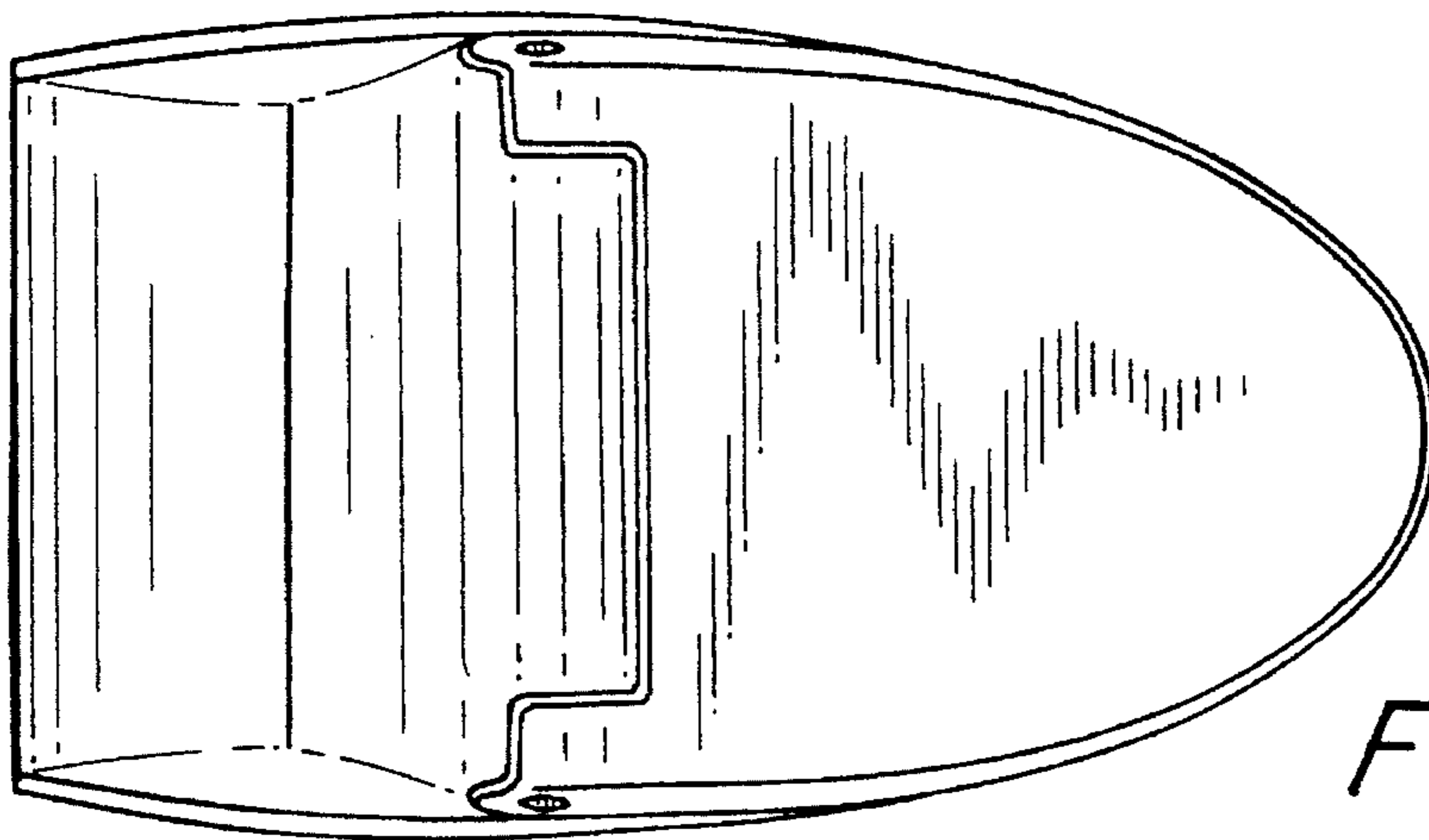

FIG. 4

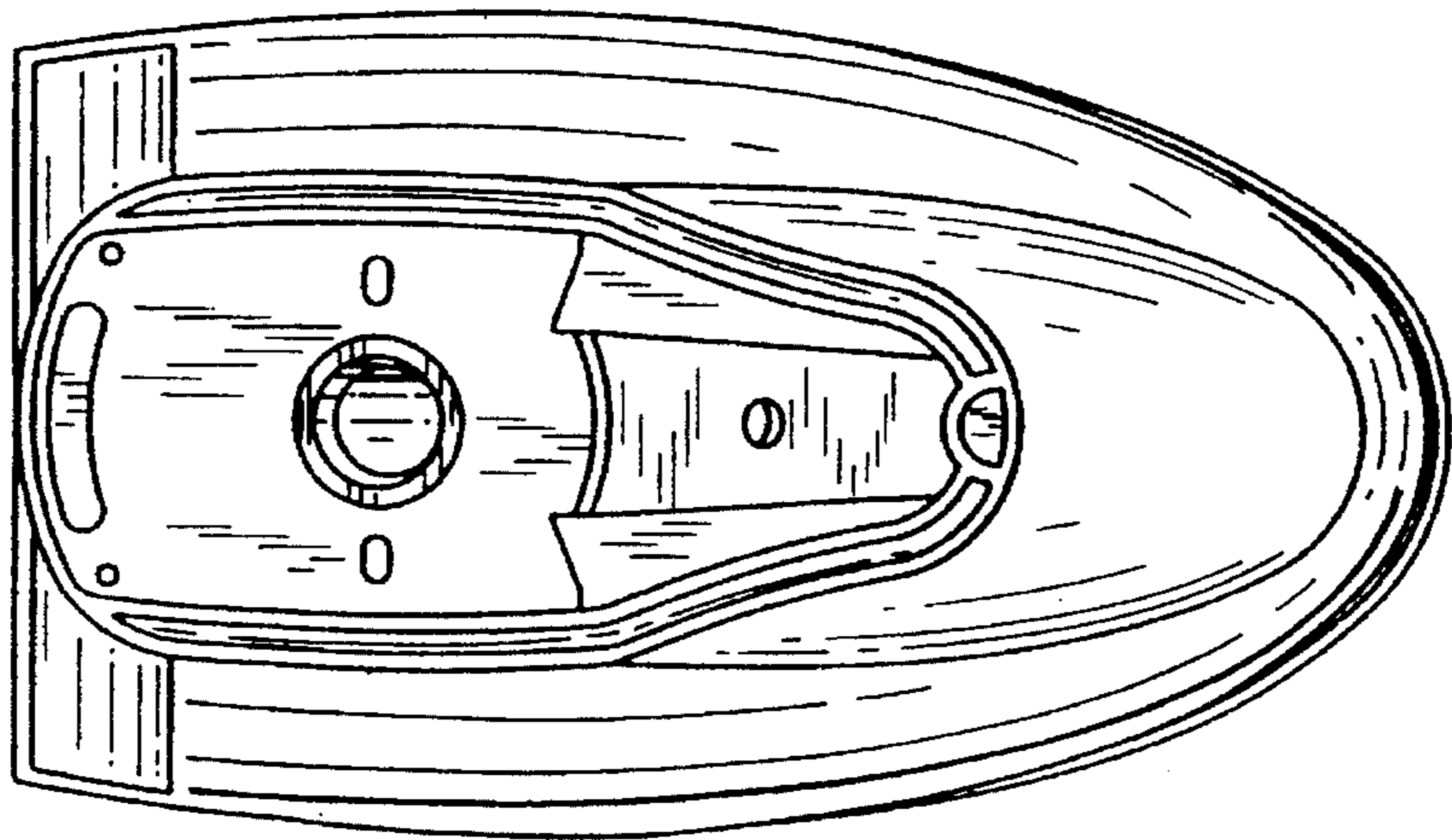

FIG. 5

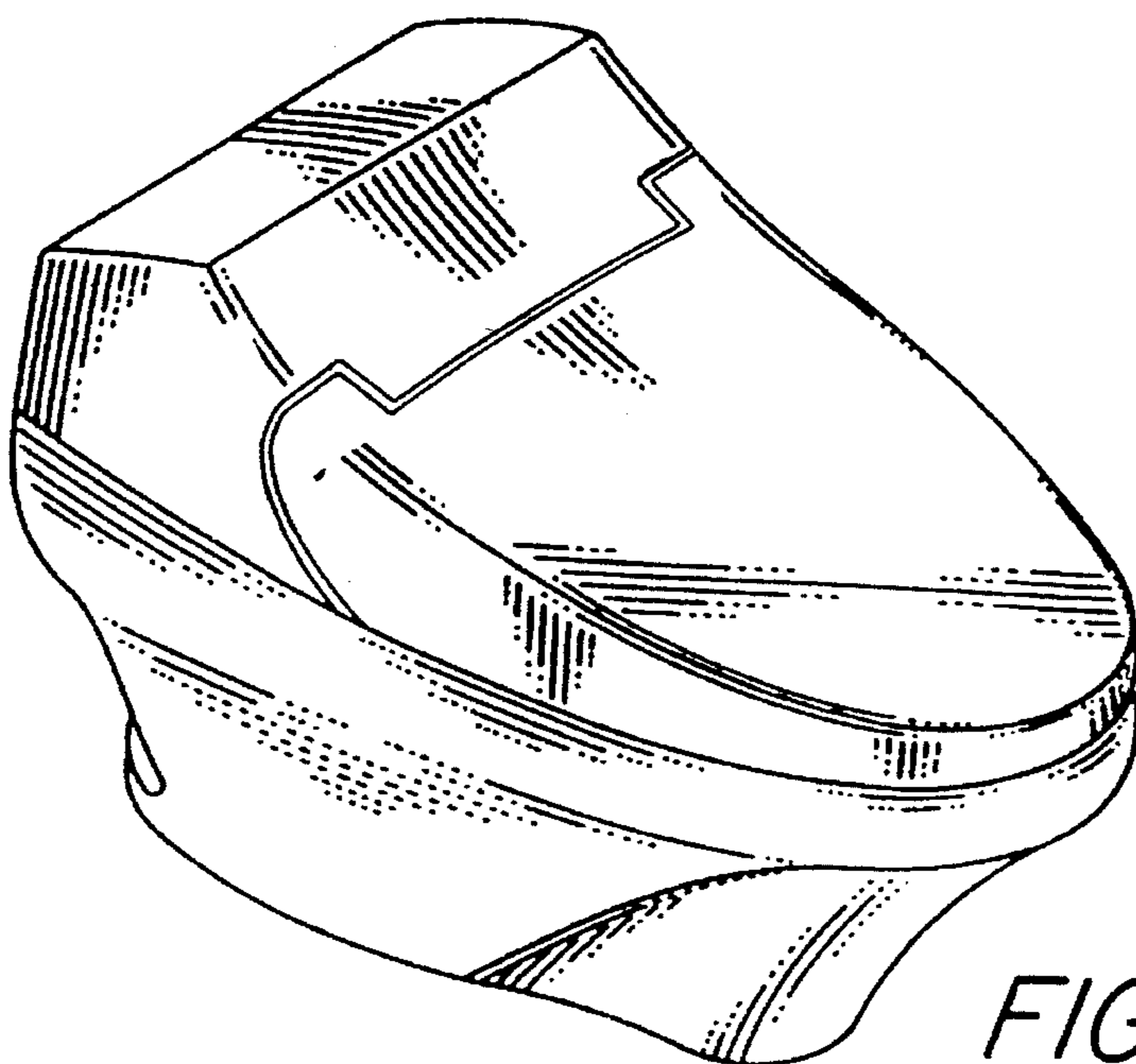

FIG. 6

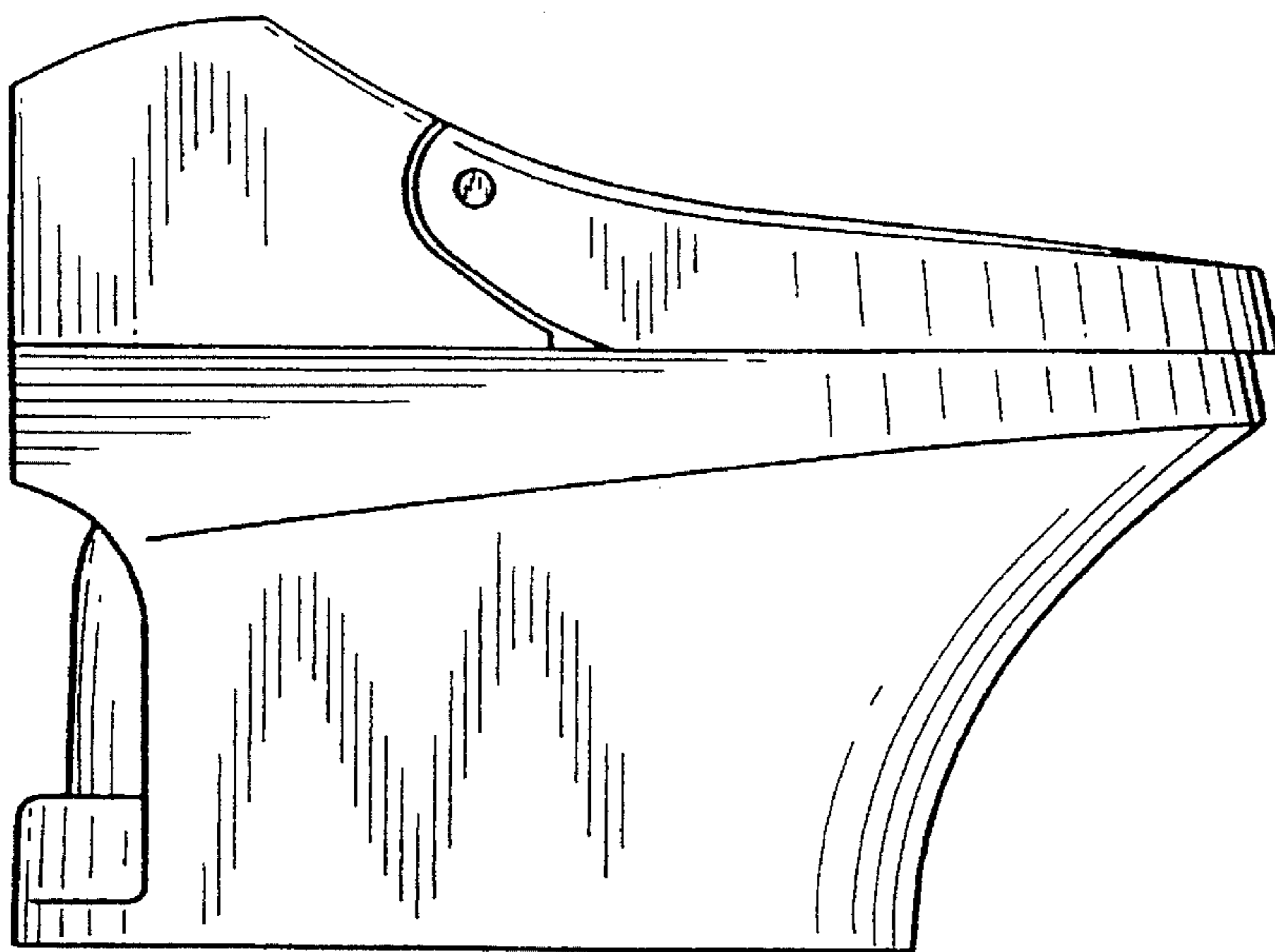

FIG. 7

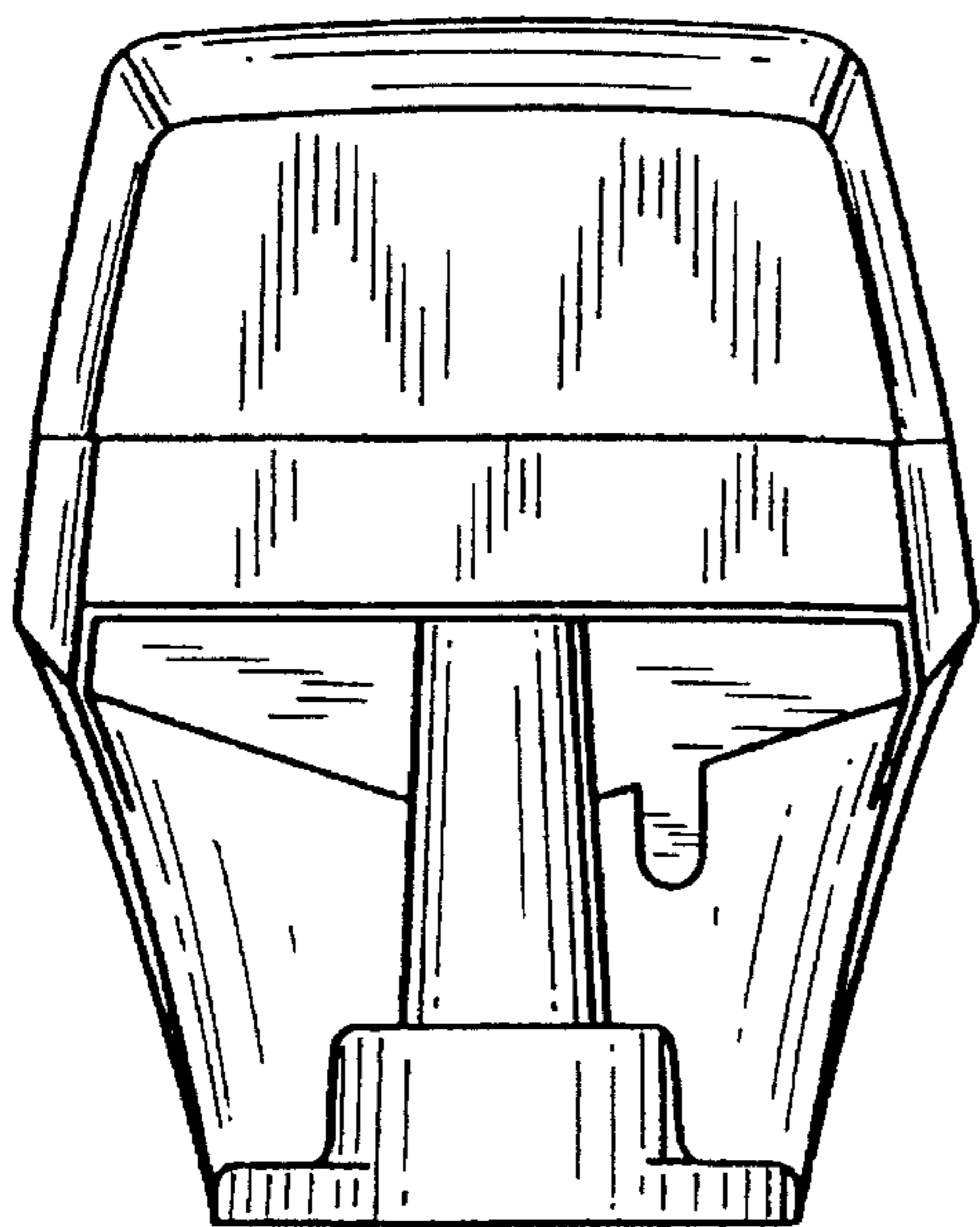

FIG. 8

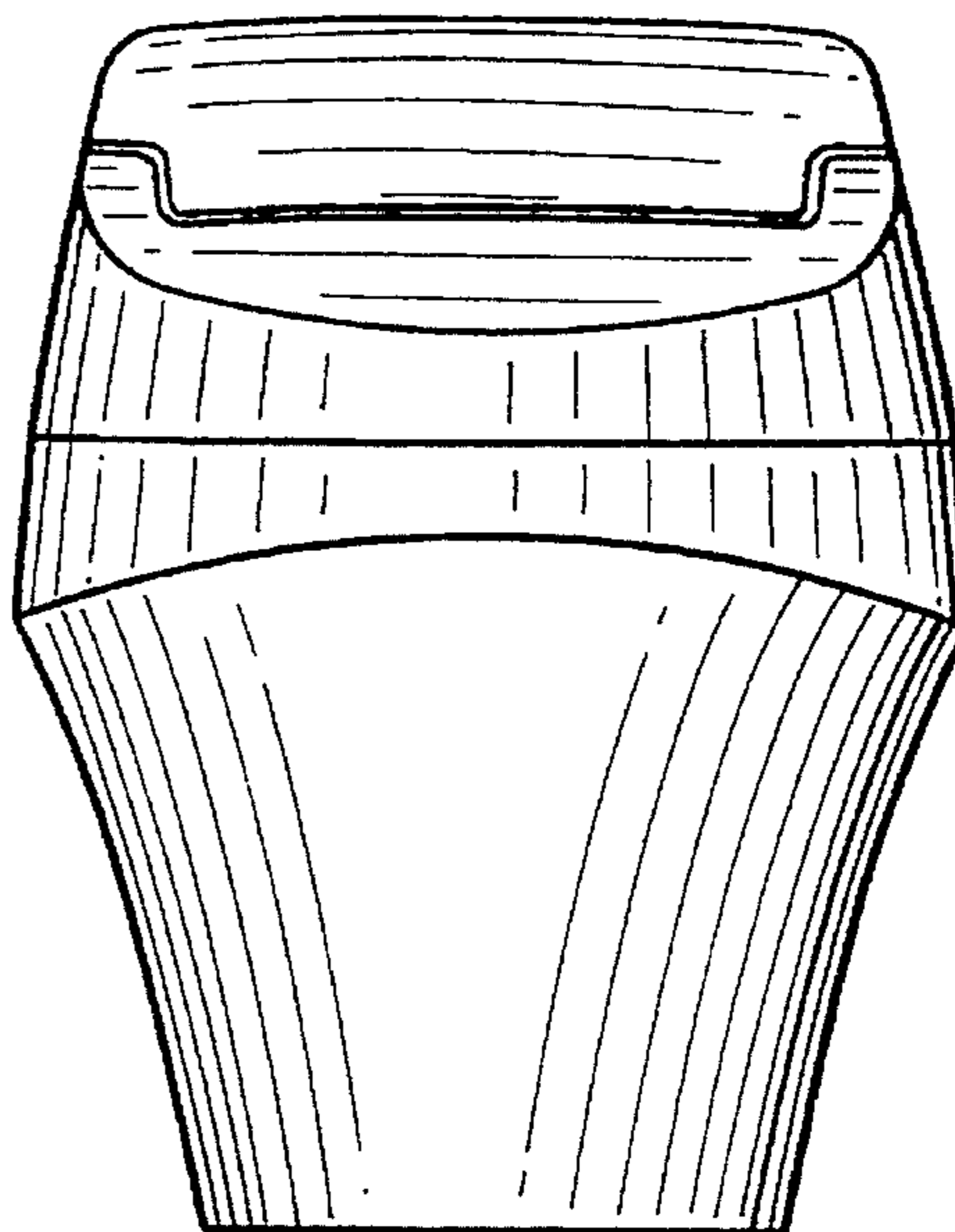

FIG. 9

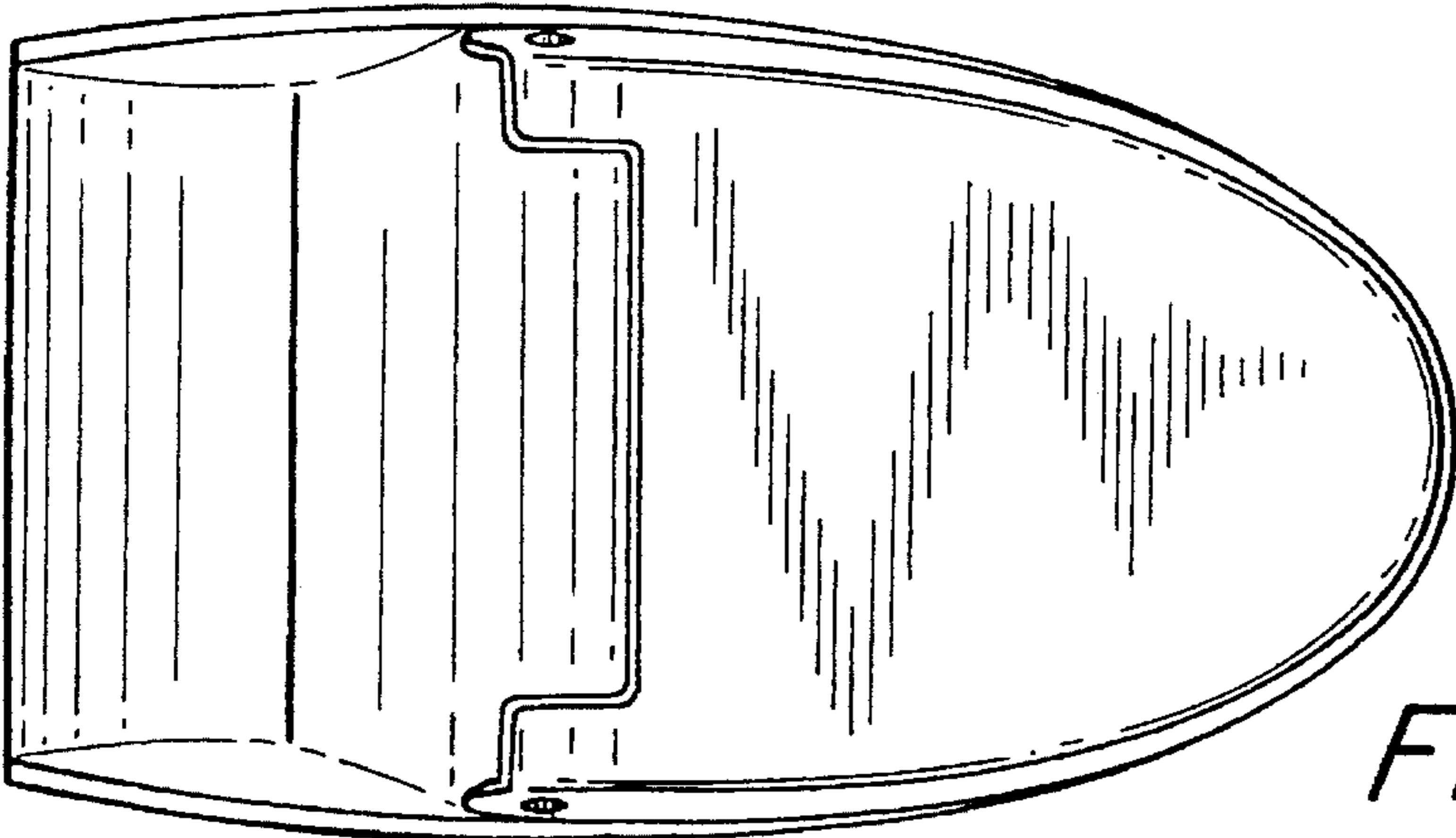

FIG. 10

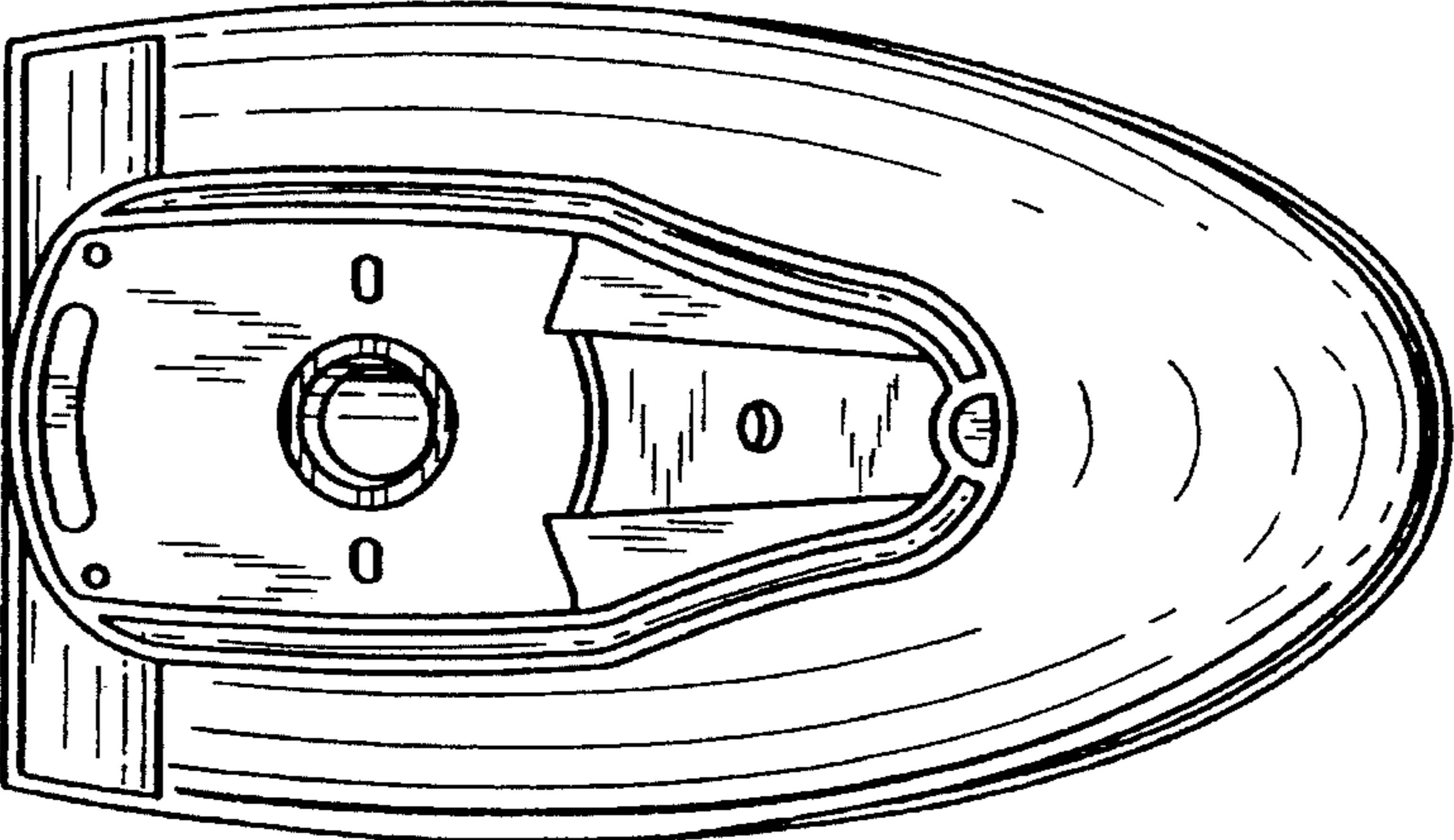

FIG. 11

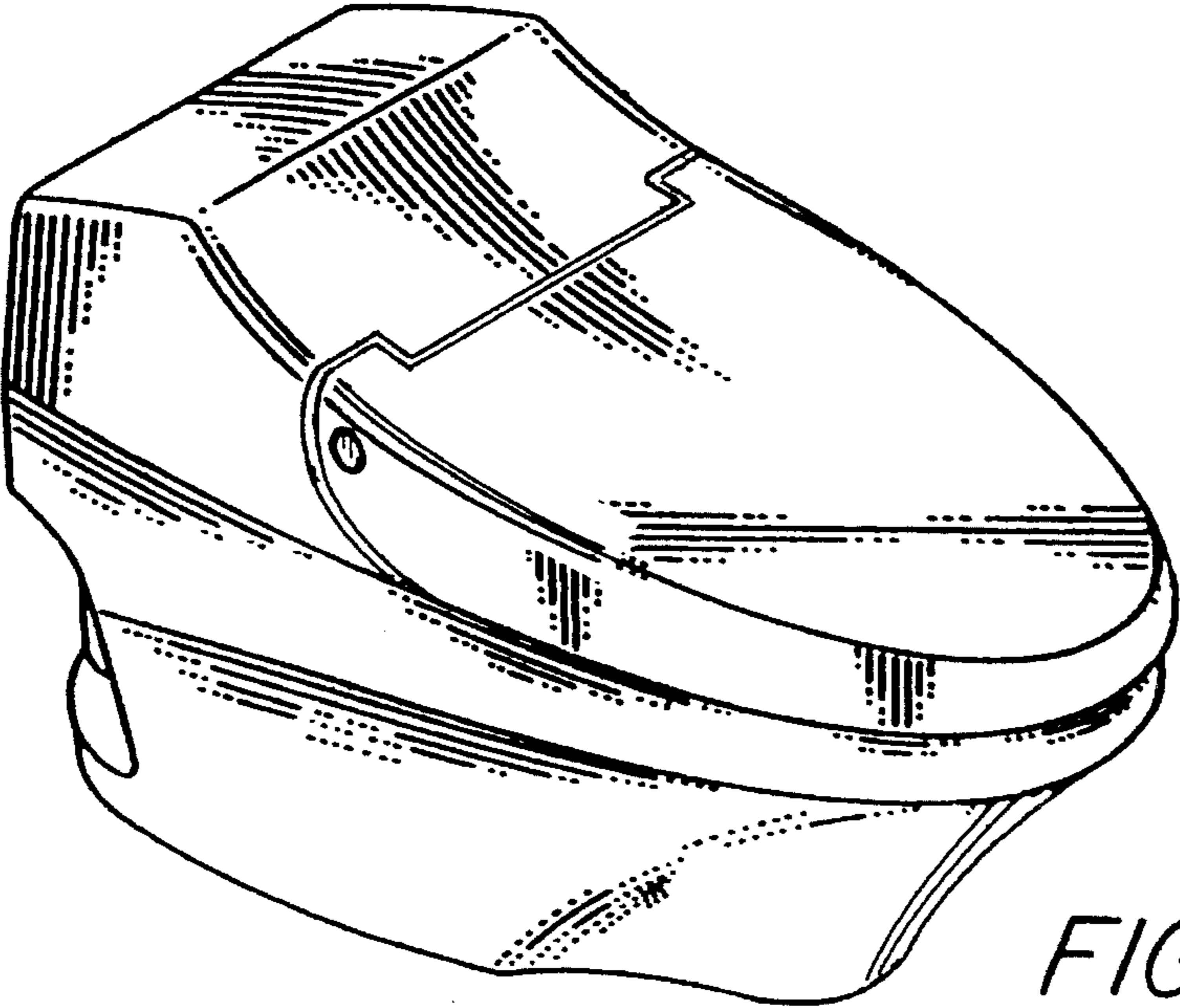

FIG. 12