



US00D369387S

**United States Patent** [19]  
**Stambolic et al.**

[11] **Patent Number: Des. 369,387**  
[45] **Date of Patent: \*\*Apr. 30, 1996**

[54] **HAND-HELD ELECTRONIC GAME HOUSING**

[75] Inventors: **Zarko Stambolic**, Oak Park; **Shari L. Smith**, Chicago; **Howard J. Morrison**, Riverwoods, all of Ill.

[73] Assignee: **Tiger Electronics, Inc.**, Vernon Hills, Ill.

[\*\*] Term: **14 Years**

[21] Appl. No.: **31,364**

[22] Filed: **Nov. 23, 1994**

[52] U.S. Cl. .... **D21/13**

[58] **Field of Search** ..... D21/13, 48; 273/148 B, 273/433-438, DIG. 28; D14/124, 125

[56] **References Cited**

**U.S. PATENT DOCUMENTS**

D. 270,075	8/1983	Tsuyuki	.....	D21/13
D. 320,624	10/1991	Taylor	.....	D21/13
5,161,803	11/1992	Ohara	.....	273/DIG. 28 X
5,213,327	5/1993	Kitaue	.....	273/434 X
5,232,223	8/1993	Dornbusch	.....	273/438 X

**OTHER PUBLICATIONS**

Playthings, Mar. 1980, p. 16 Lakeside's le Boom.  
Hong Kong Enterprise Oct. 1992, p. 279 Pen-cu-lator.  
Hong Kong Enterprises, Oct. 1992, p. 353.  
MIDWAY MORTAL KOMBAT product, shown on p. 84 (copyright 1992) from Jan. 1994 edition of Tiger Electronics, Inc. book entitled *Lightning Strikes Again*.

*Primary Examiner*—Prabhakar G. Deshmukh  
*Attorney, Agent, or Firm*—Fitch, Even, Tabin & Flannery

[57] **CLAIM**

The ornamental design for the hand-held electronic game housing, as shown and described.

**DESCRIPTION**

FIG. 1 is a perspective view of a hand-held electronic game housing showing our new design;  
FIG. 2 is a top plan view thereof;  
FIG. 3 is a front elevational view thereof;  
FIG. 4 is a bottom plan view thereof;  
FIG. 5 is a rear elevational view thereof;  
FIG. 6 is a left side elevational view thereof; and,  
FIG. 7 is a right side elevational view thereof.

**1 Claim, 2 Drawing Sheets**

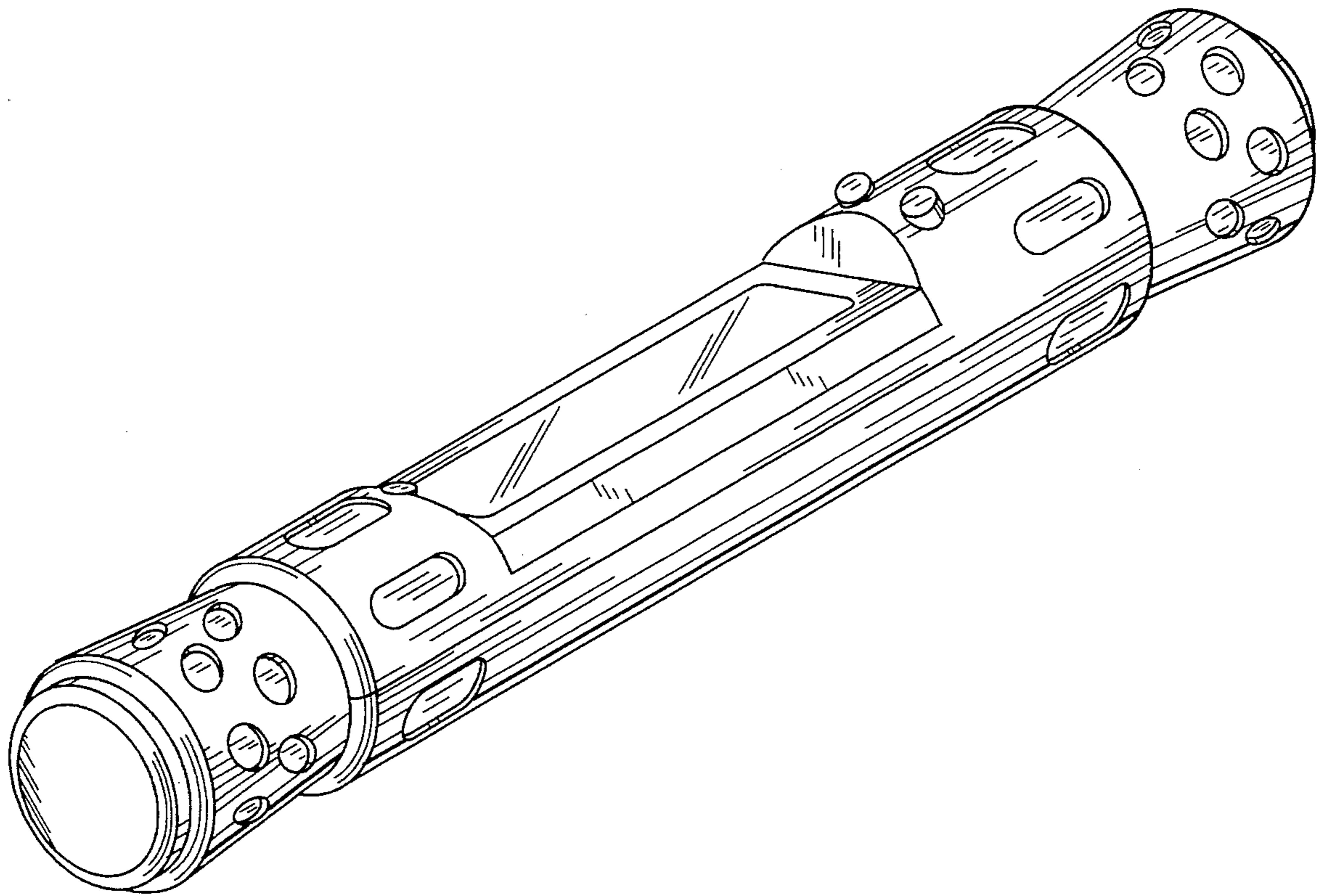

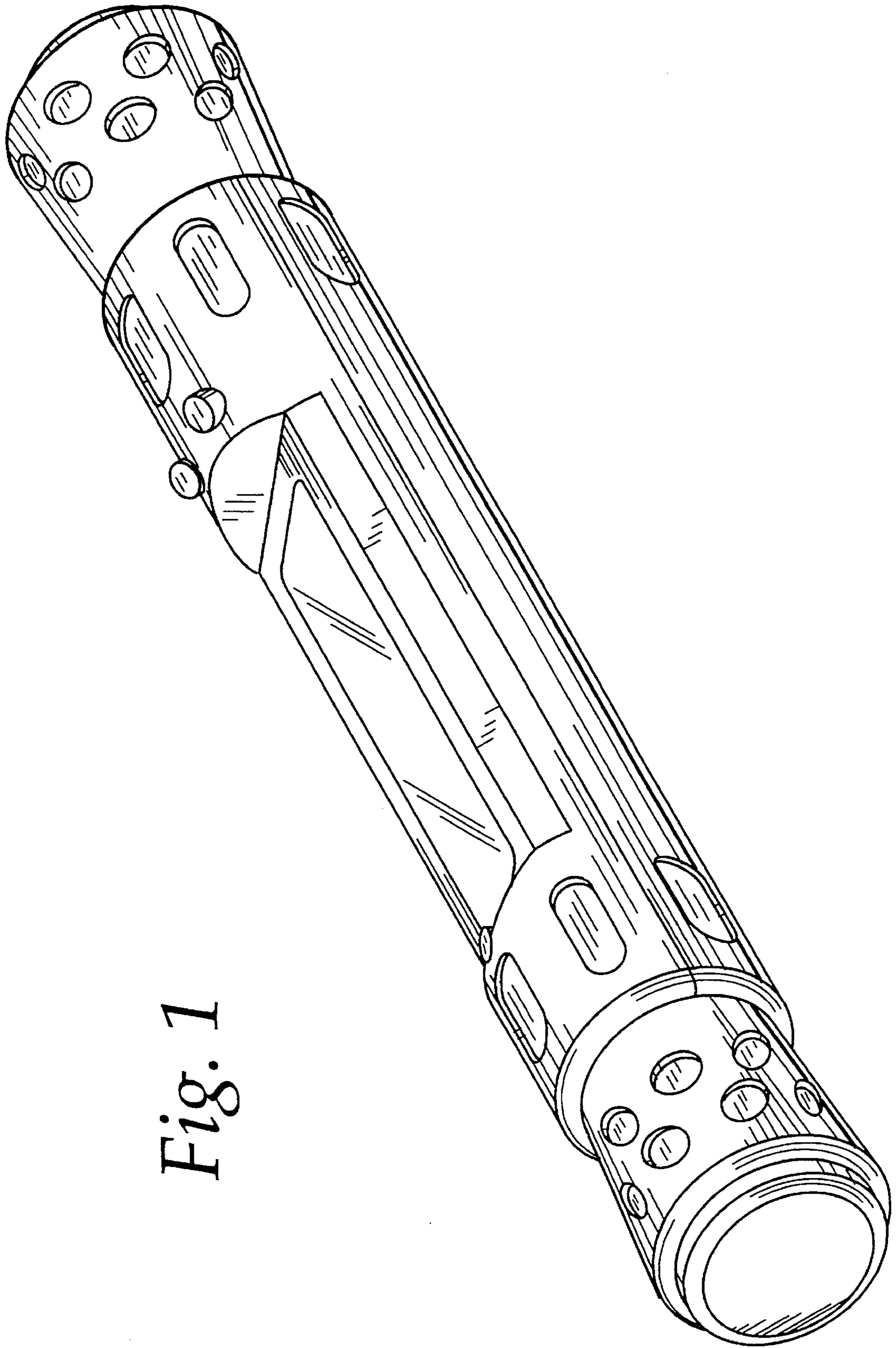
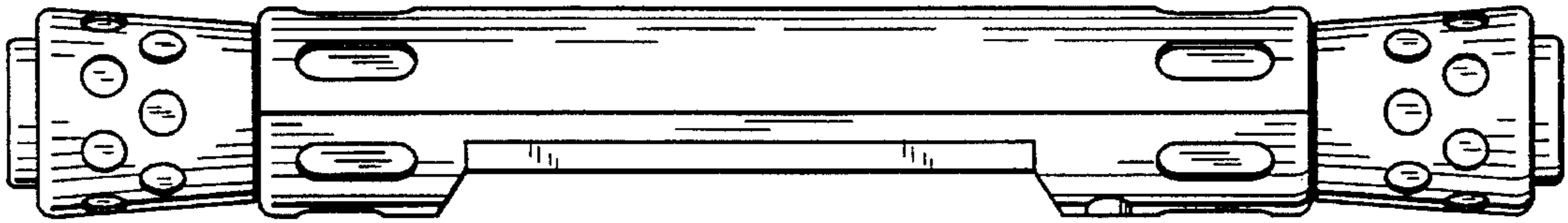
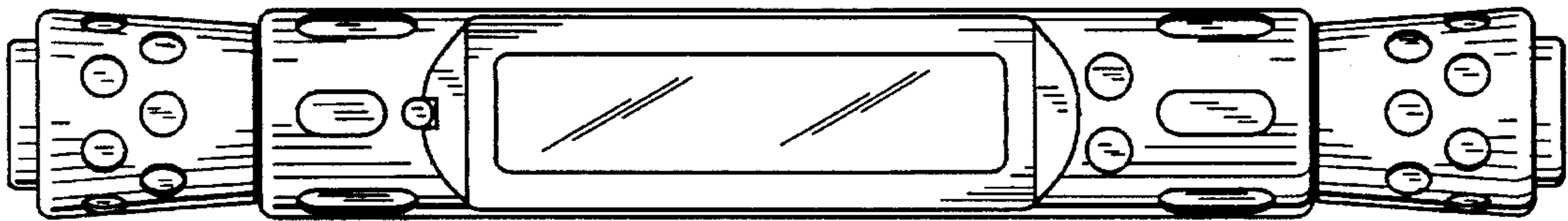

Fig. 1

*Fig. 2*



*Fig. 3*



*Fig. 4*

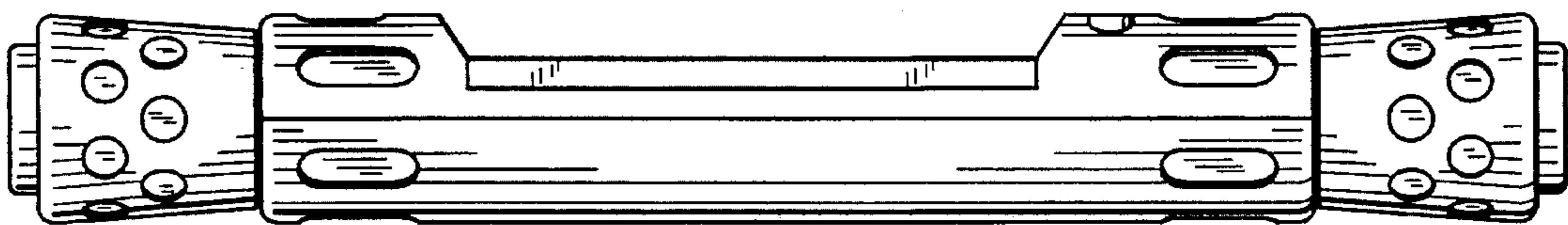

*Fig. 5*

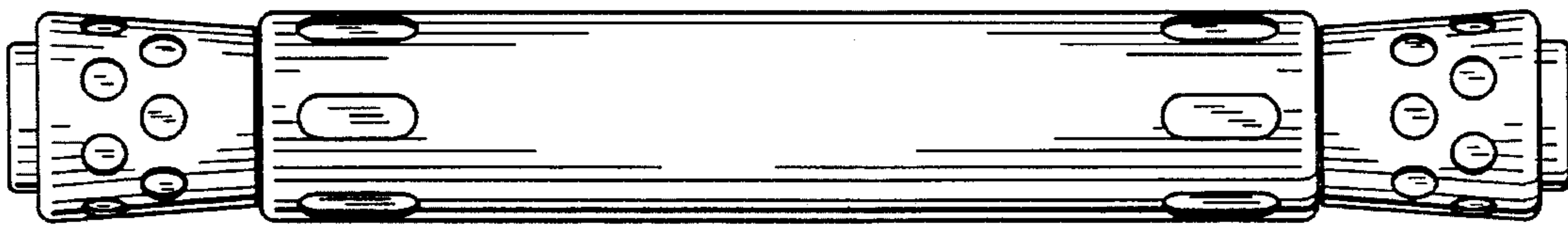

*Fig. 6*

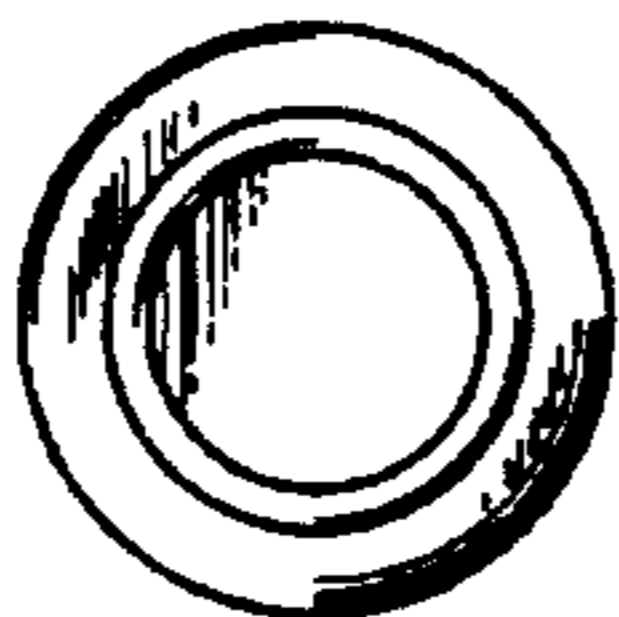

*Fig. 7*

