



US00D369284S

United States Patent [19]

Bird et al.

[11] Patent Number: **Des. 369,284**

[45] Date of Patent: ****Apr. 30, 1996**

- [54] **BARBECUE GRILL ASH SWEEP**
- [75] Inventors: **Richard Bird**, Louisville, Ky.; **Calvin Sprinkle**, Borden, Ind.
- [73] Assignee: **Porcelain Metals Corporation**, Louisville, Ky.
- [**] Term: **14 Years**
- [21] Appl. No.: **27,089**
- [22] Filed: **Aug. 12, 1994**
- [52] U.S. Cl. **D7/690**; D7/402
- [58] Field of Search D7/402, 669, 688, D7/690-692, 404, 332; 294/19 A, 27 R, 32, 31.2

4,576,140	3/1986	Schlosser	126/25 R
4,587,947	5/1986	Tomita	126/25 R
4,777,927	10/1988	Stephen et al.	126/25 R
4,895,134	1/1990	Fielding et al.	126/243
5,036,832	8/1991	Schlosser et al.	126/243

Primary Examiner—Alan P. Douglas
Assistant Examiner—Caron D. Veynar
Attorney, Agent, or Firm—Middleton & Reutlinger; David W. Carrithers

[57] CLAIM

The ornamental design for a barbecue grill ash sweep, as shown and described.

DESCRIPTION

FIG. 1 is a perspective view of a barbecue grill ash sweep showing our new design;
 FIG. 2 is a front elevational view thereof;
 FIG. 3 is a top plan view thereof;
 FIG. 4 is a right side elevational view, the left side view being a mirror image thereof;
 FIG. 5 is a bottom plan view thereof;
 FIG. 6 is a rear elevational view thereof; and,
 FIG. 7 is a front perspective view of the ash sweep, the broken line showing of a barbecue grill is for illustrative purposes only and forms no part of the claimed design.

[56] **References Cited**

U.S. PATENT DOCUMENTS

Re. 33,091	10/1989	Schlosser	126/9 B
D. 256,315	8/1980	Eskew, Jr.	D7/690
D. 280,282	8/1985	Erbach	D7/404
D. 293,191	12/1987	Stephen et al.	D7/332
2,836,402	5/1958	Barnes et al.	D7/690 X
3,807,380	4/1974	Pasia	126/25 R
4,416,248	11/1983	Schlosser	126/9 B
4,458,585	7/1984	Erbach	99/419
4,498,452	2/1985	Schlosser et al.	126/9 R

1 Claim, 3 Drawing Sheets

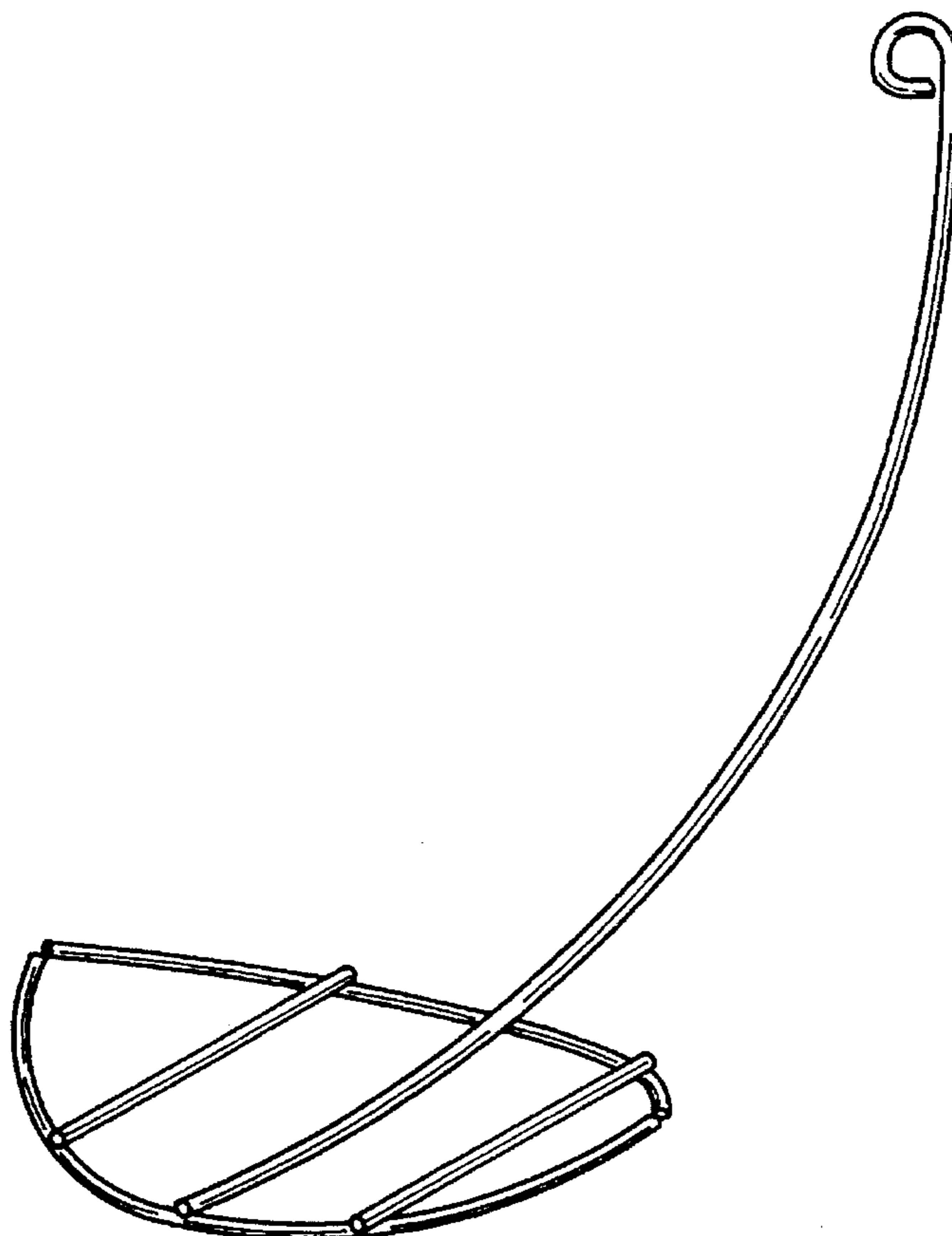

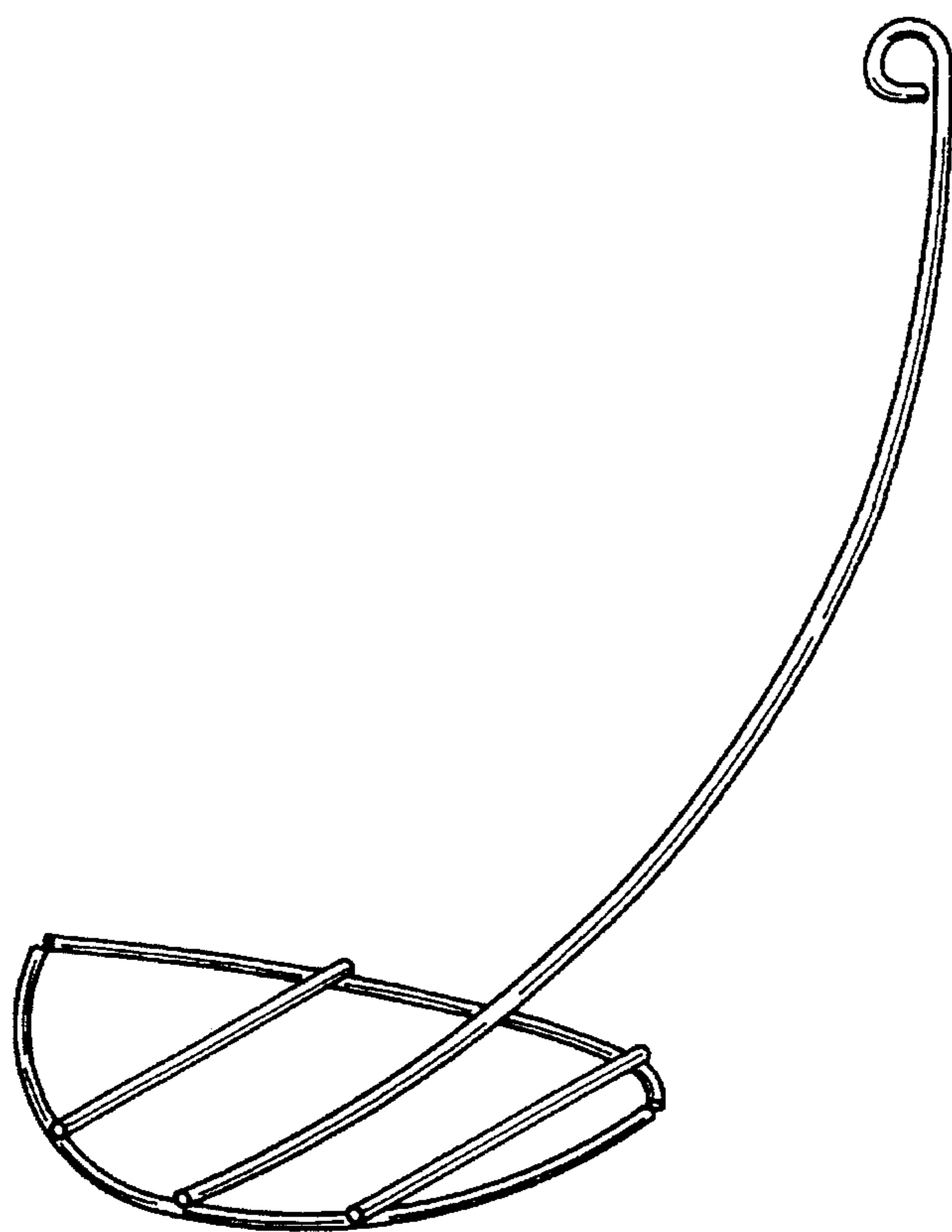

FIG. 1

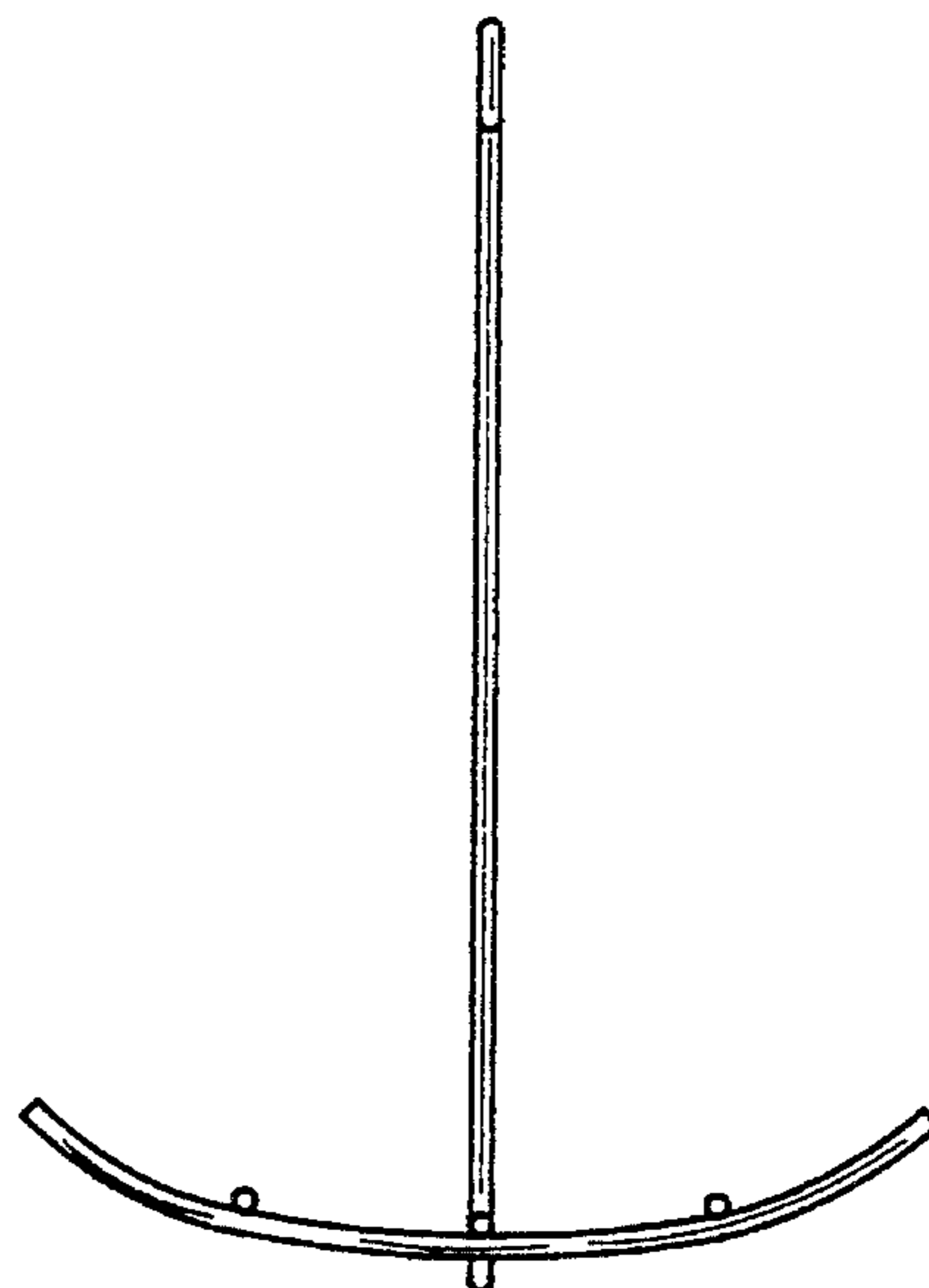

FIG. 2

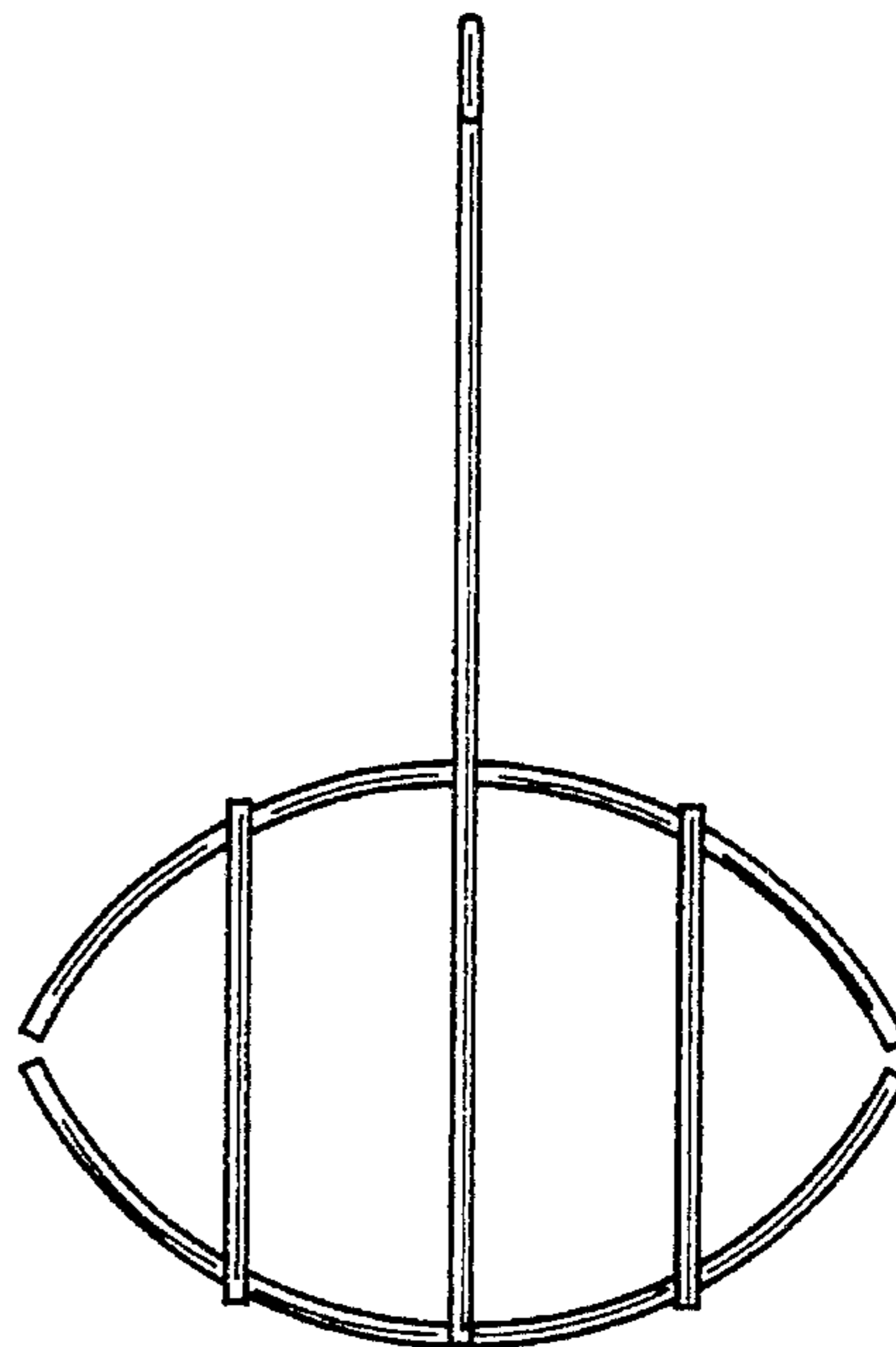

FIG. 3

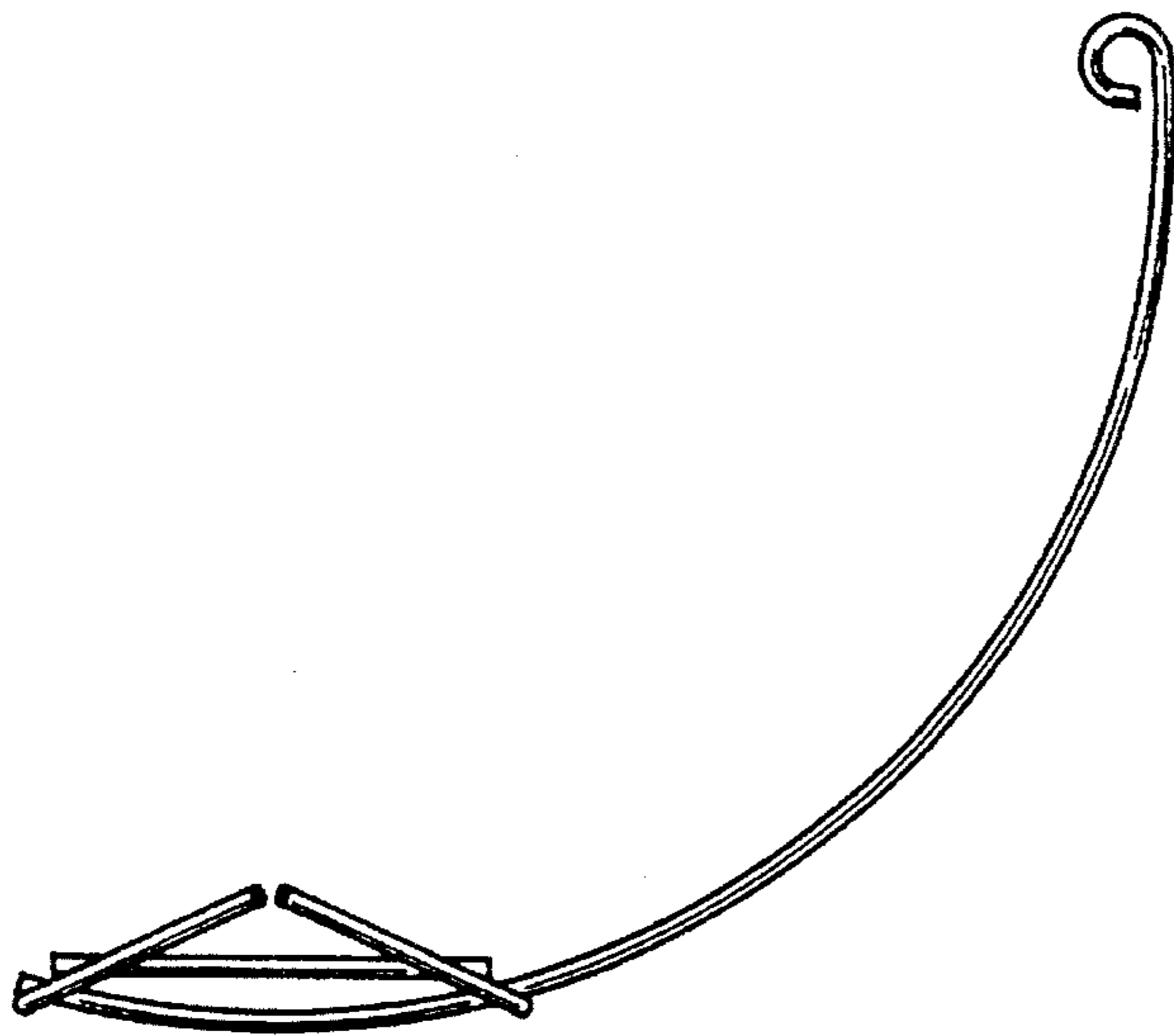

FIG. 4

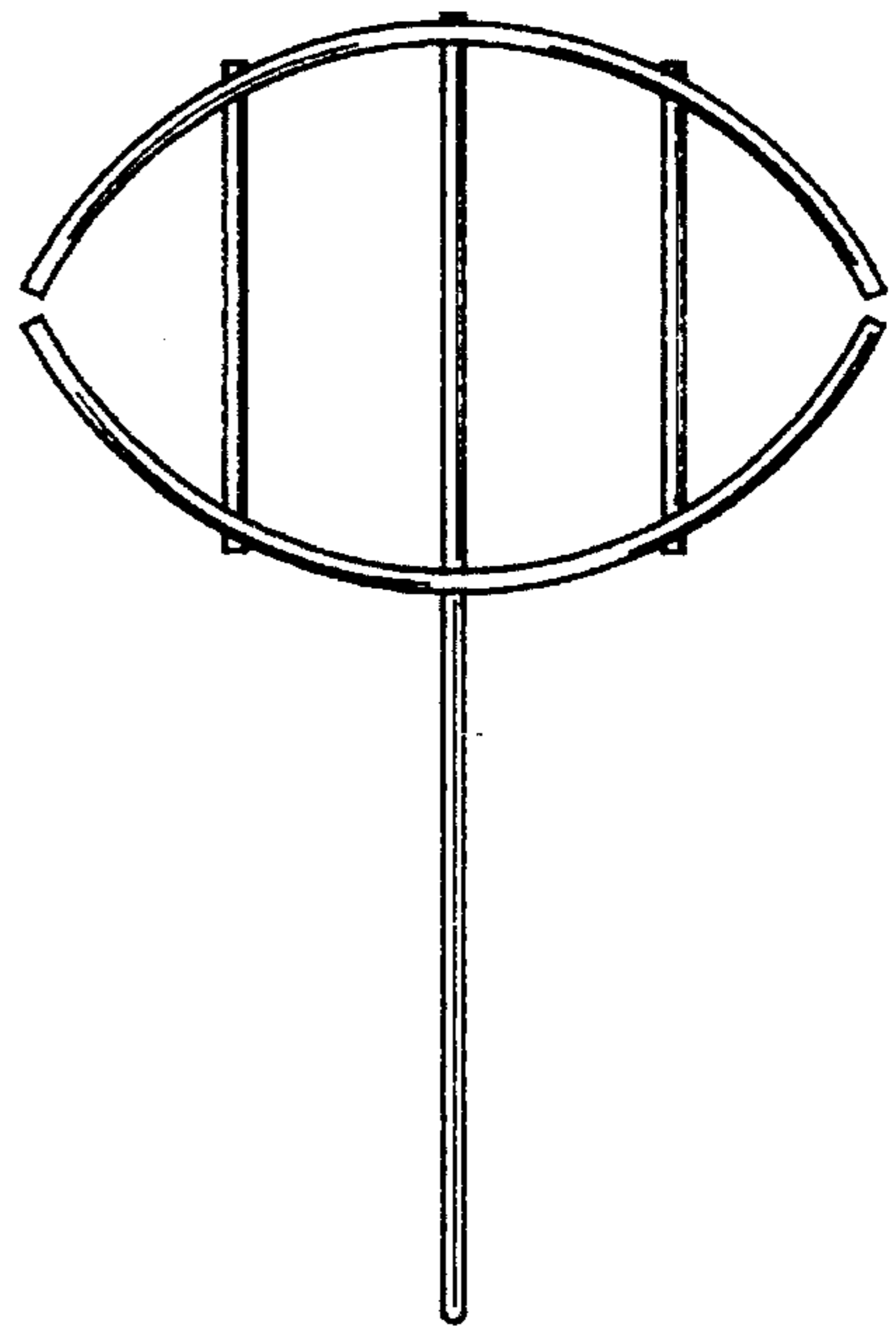

FIG. 5

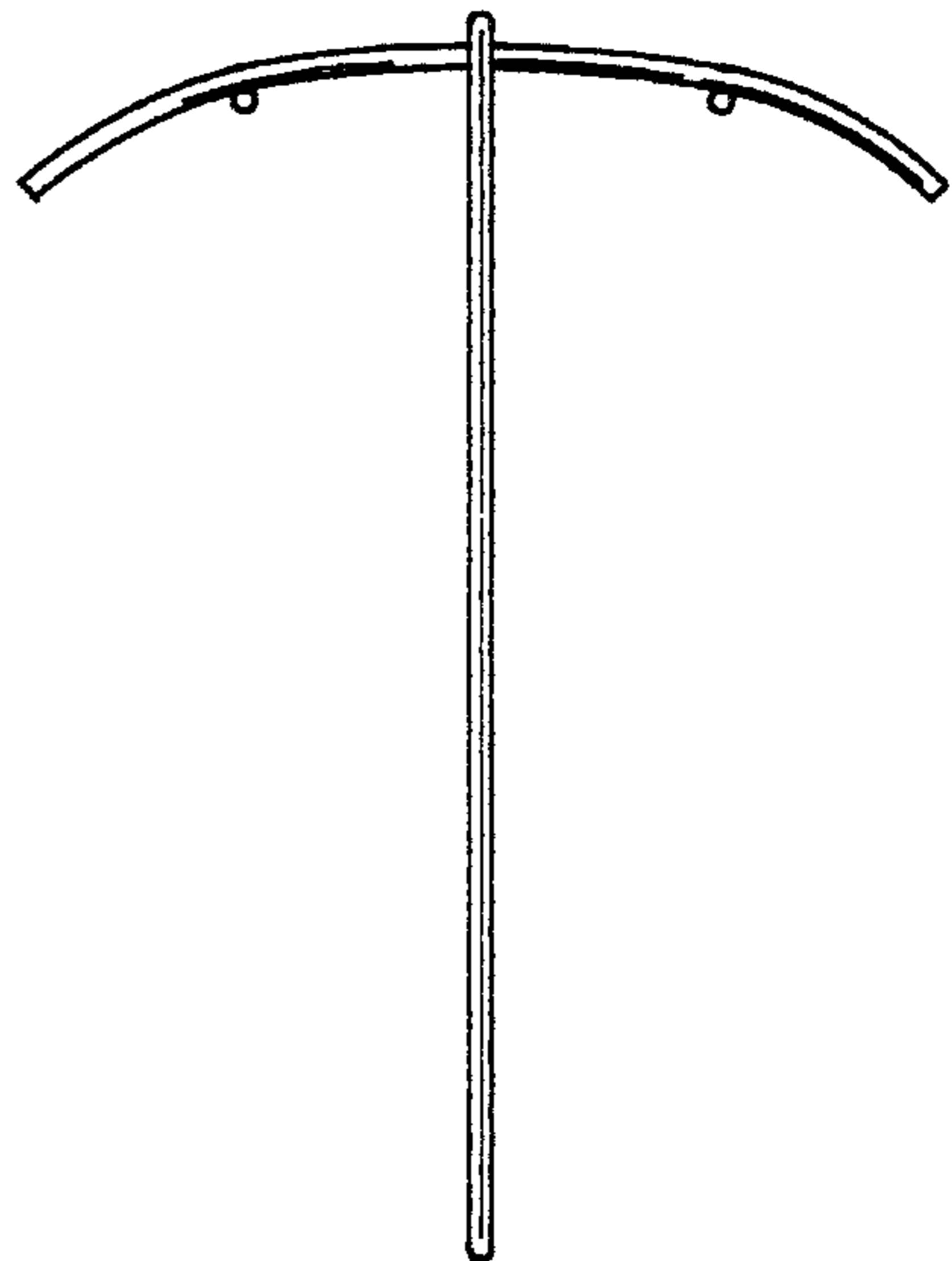

FIG. 6

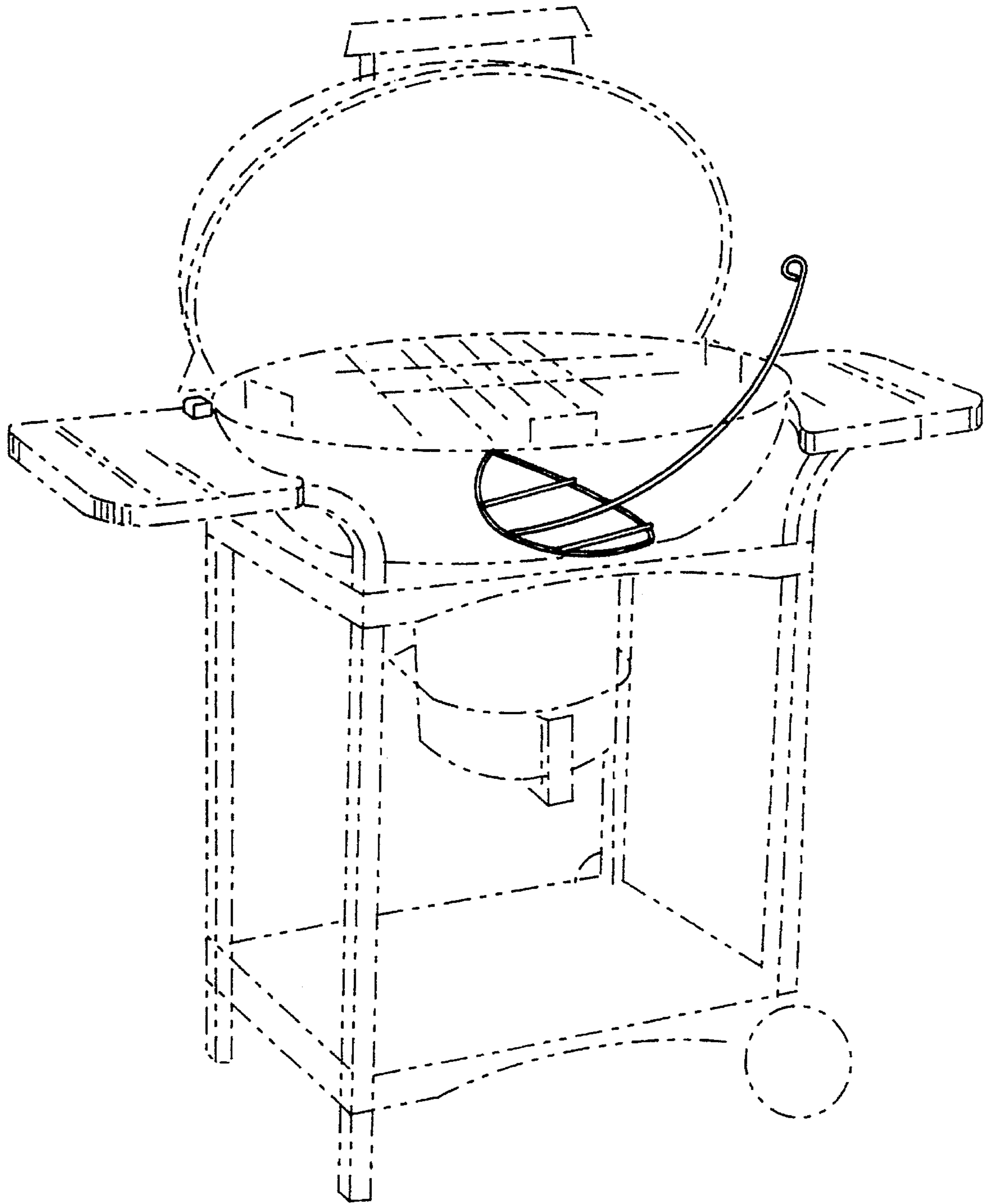

FIG. 7