



US00D369180S

# United States Patent [19]

Fukaya et al.

[11] Patent Number: **Des. 369,180**

[45] Date of Patent: **\*\*Apr. 23, 1996**

[54] **PRINTER**

[75] Inventors: **Masako Fukaya; Koji Kimura; Makoto Tsuchida**, all of Kawasaki; **Susumu Iida**, Inagi, all of Japan

[73] Assignees: **Fujitsu Limited**, Kawasaki; **Fujitsu Isotec Limited**, Tokyo, both of Japan

[\*\*] Term: **14 Years**

[21] Appl. No.: **32,415**

[22] Filed: **Dec. 19, 1994**

### [30] Foreign Application Priority Data

Jun. 17, 1994 [JP] Japan ..... 6-17880

[52] U.S. Cl. .... **D18/50**

[58] Field of Search ..... D18/50, 54-55; 400/690-691, 690.1-690.4, 613, 613.1-613.4; D14/118

### [56] References Cited

#### U.S. PATENT DOCUMENTS

- D. 286,639 11/1986 Strand ..... D18/55
- D. 293,113 12/1987 Foy ..... D18/54
- D. 293,578 1/1988 Matsumoto et al. .... D18/55
- D. 323,850 2/1992 Matsuo et al. .... D18/54

- D. 335,894 5/1993 Nishikaze et al. .... D18/55
- D. 343,193 1/1994 Tsuchida et al. .... D18/55
- D. 343,637 1/1994 Umino et al. .... D18/55
- D. 344,754 3/1994 Parsey ..... D18/55
- D. 349,922 8/1994 Tashiro ..... D18/50
- D. 350,364 9/1994 Kawashima et al. .... D18/50
- D. 356,818 3/1995 Sekine et al. .... D18/55

### OTHER PUBLICATIONS

Byte Publications, Inc., Sep. 1983; p. 32; Transtar advertisement for 315 color printer.

*Primary Examiner*—Cathy Anne MacCormac  
*Attorney, Agent, or Firm*—Staas & Halsey; James D. Halsey, Jr.

### [57] CLAIM

The ornamental design for a printer, as shown.

### DESCRIPTION

FIG. 1 is a front elevational view of our new printer design; FIG. 2 is a rear elevational view thereof; FIG. 3 is a top plan view thereof; FIG. 4 is a bottom plan view thereof; FIG. 5 is a left side elevational view thereof; FIG. 6 is a right side elevational view thereof; and, FIG. 7 is a perspective view thereof.

**1 Claim, 4 Drawing Sheets**

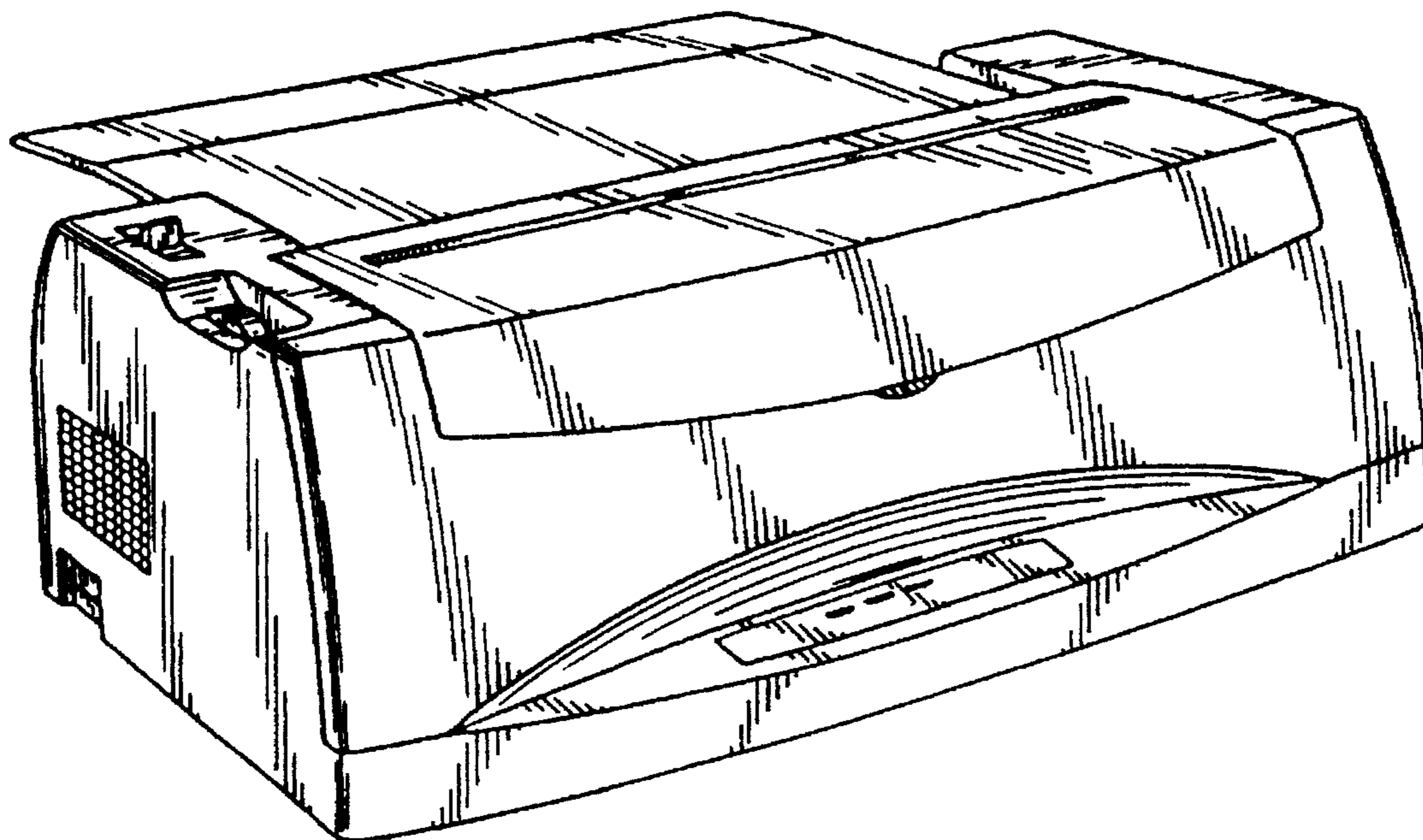

**FIG. 2**

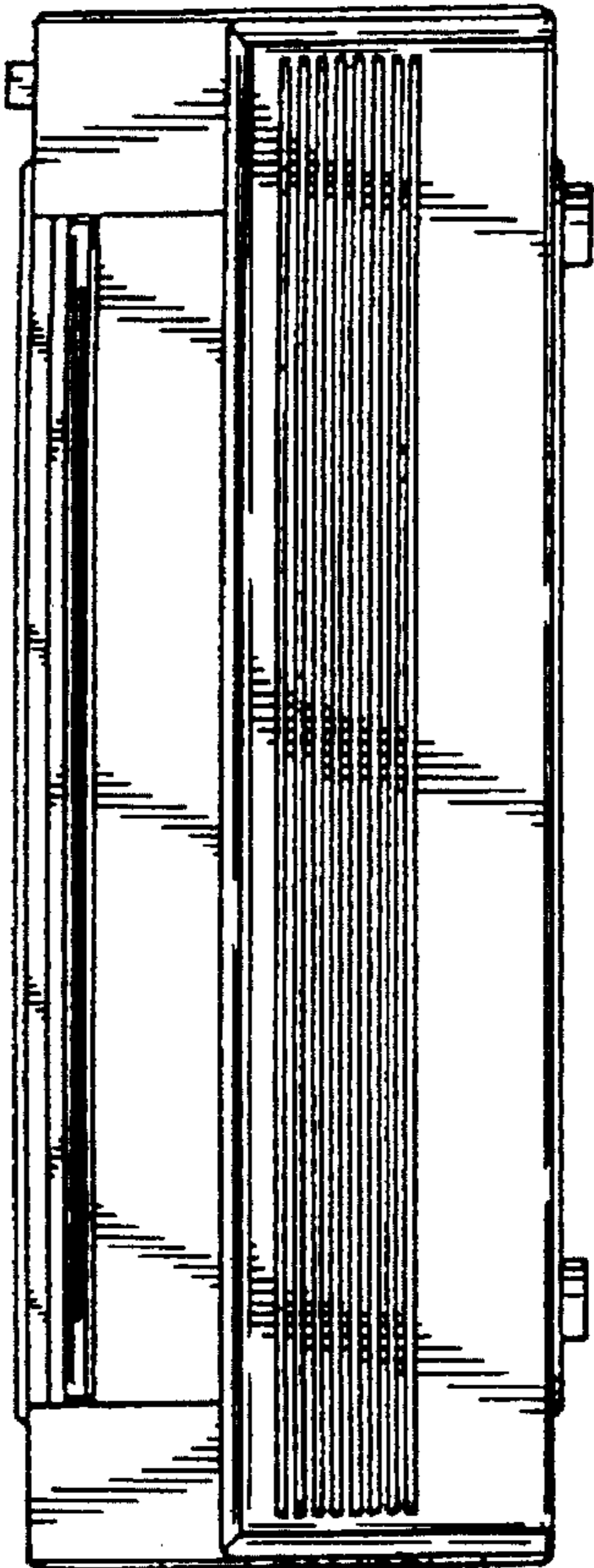

**FIG. 1**

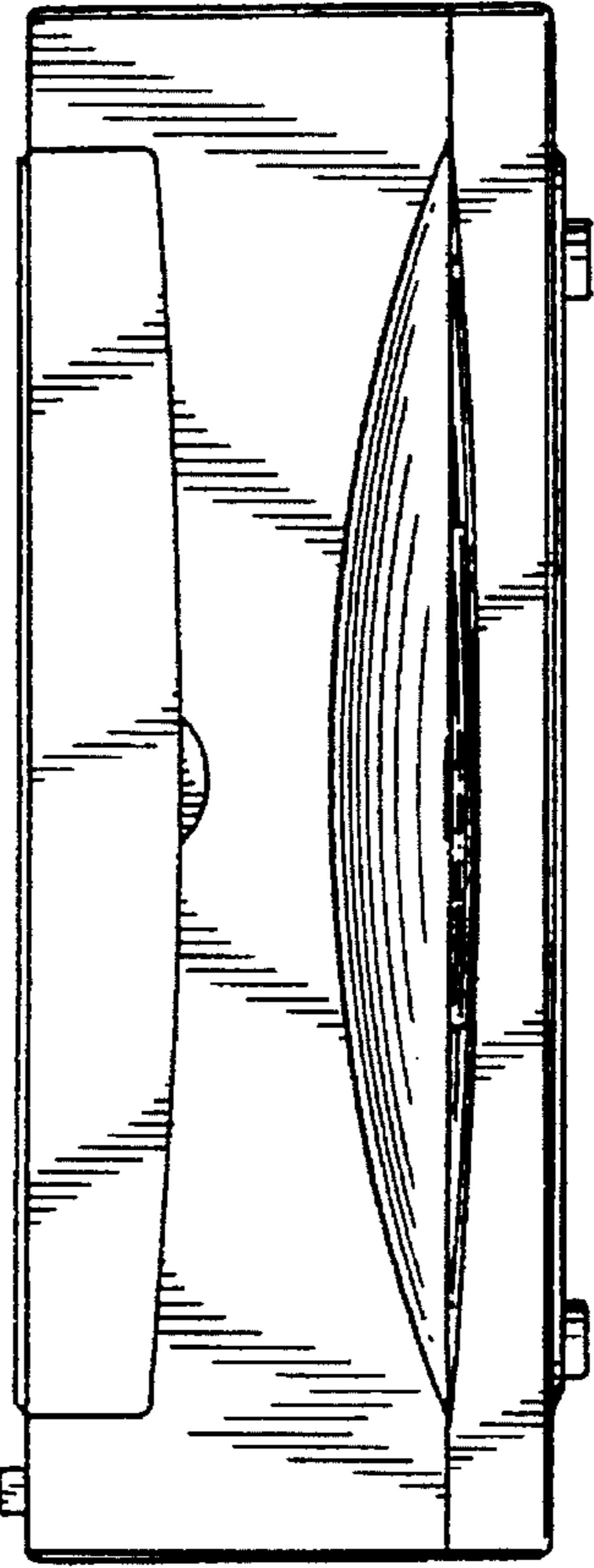

**FIG. 4**

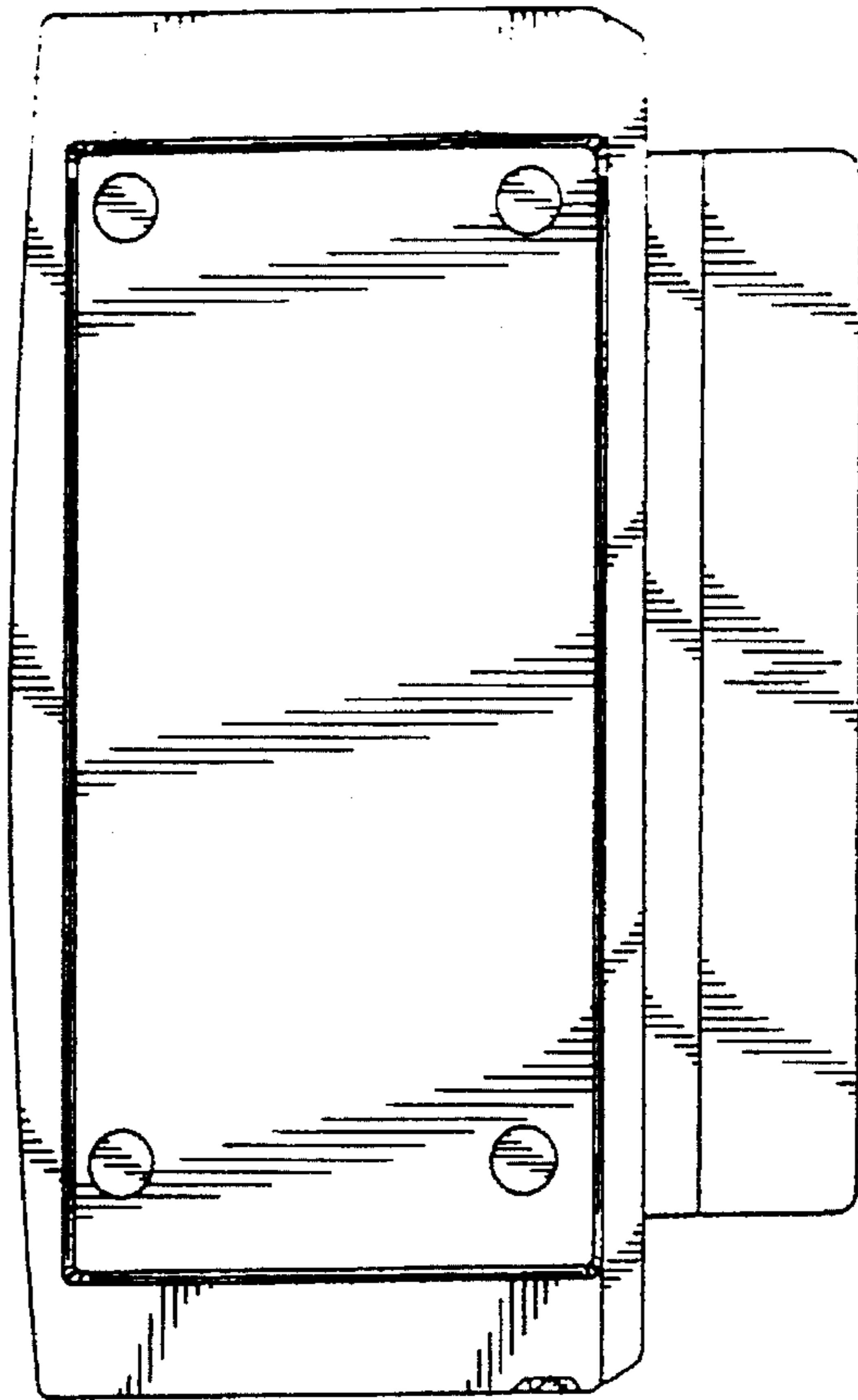

**FIG. 3**

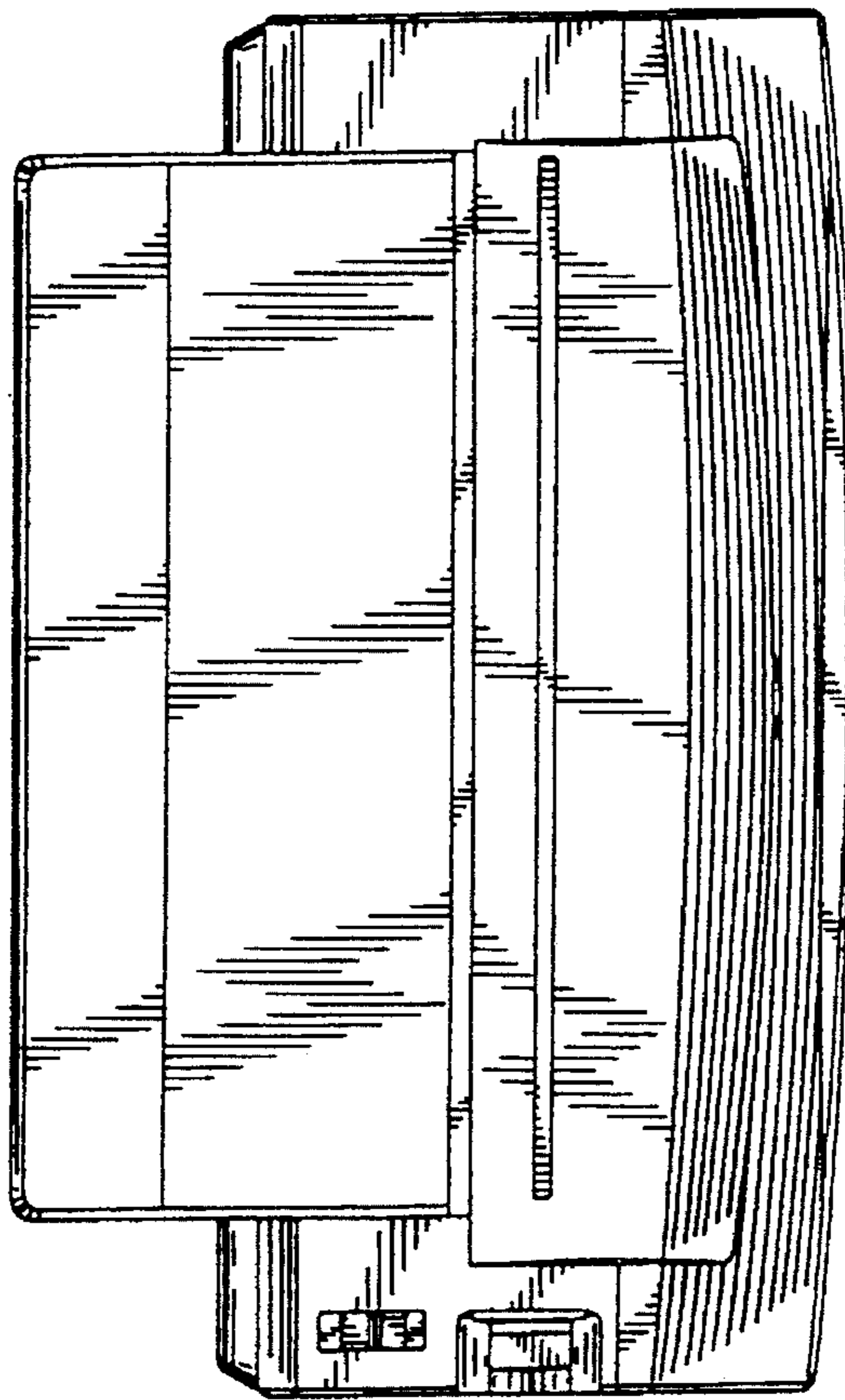

**FIG. 6**

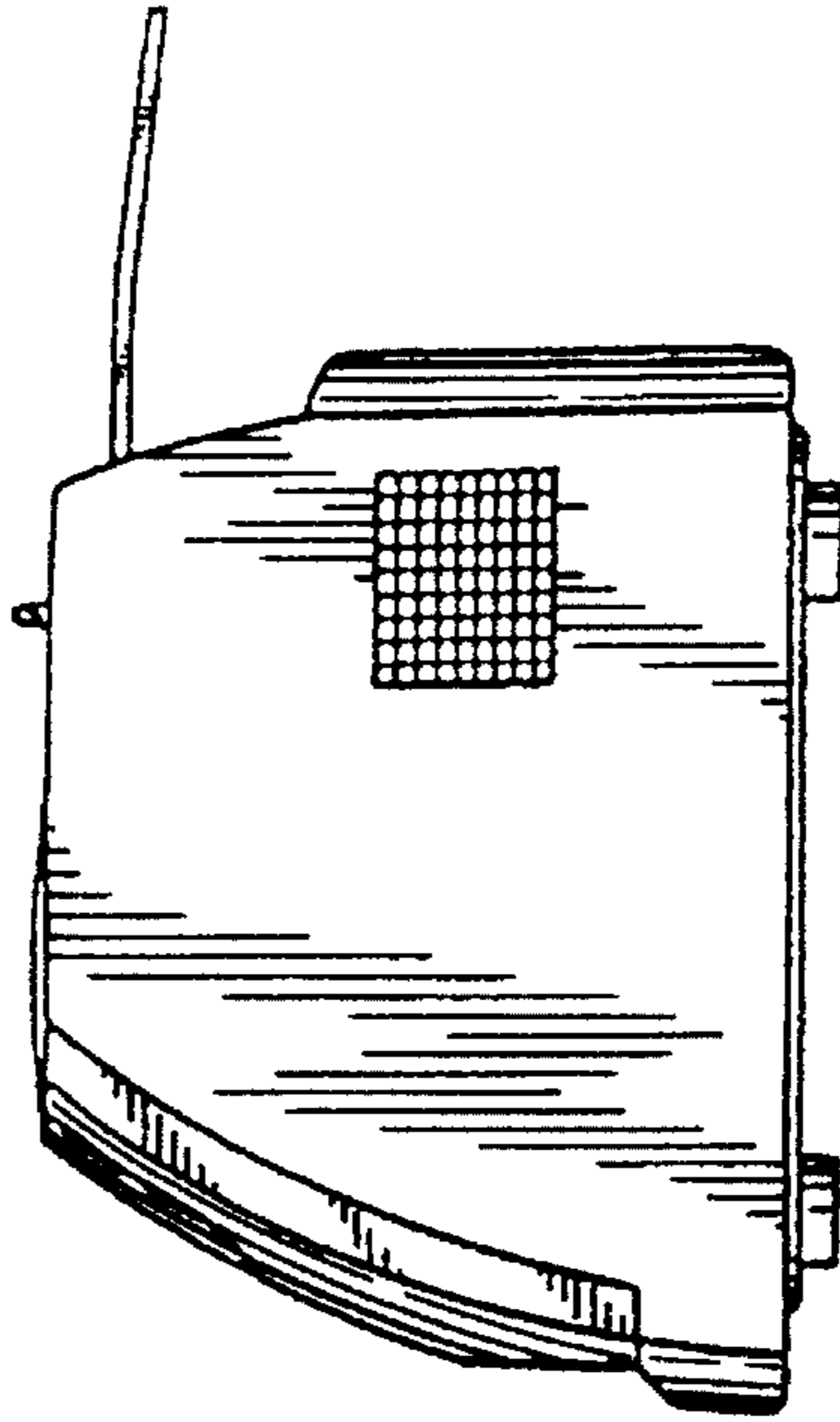

**FIG. 5**

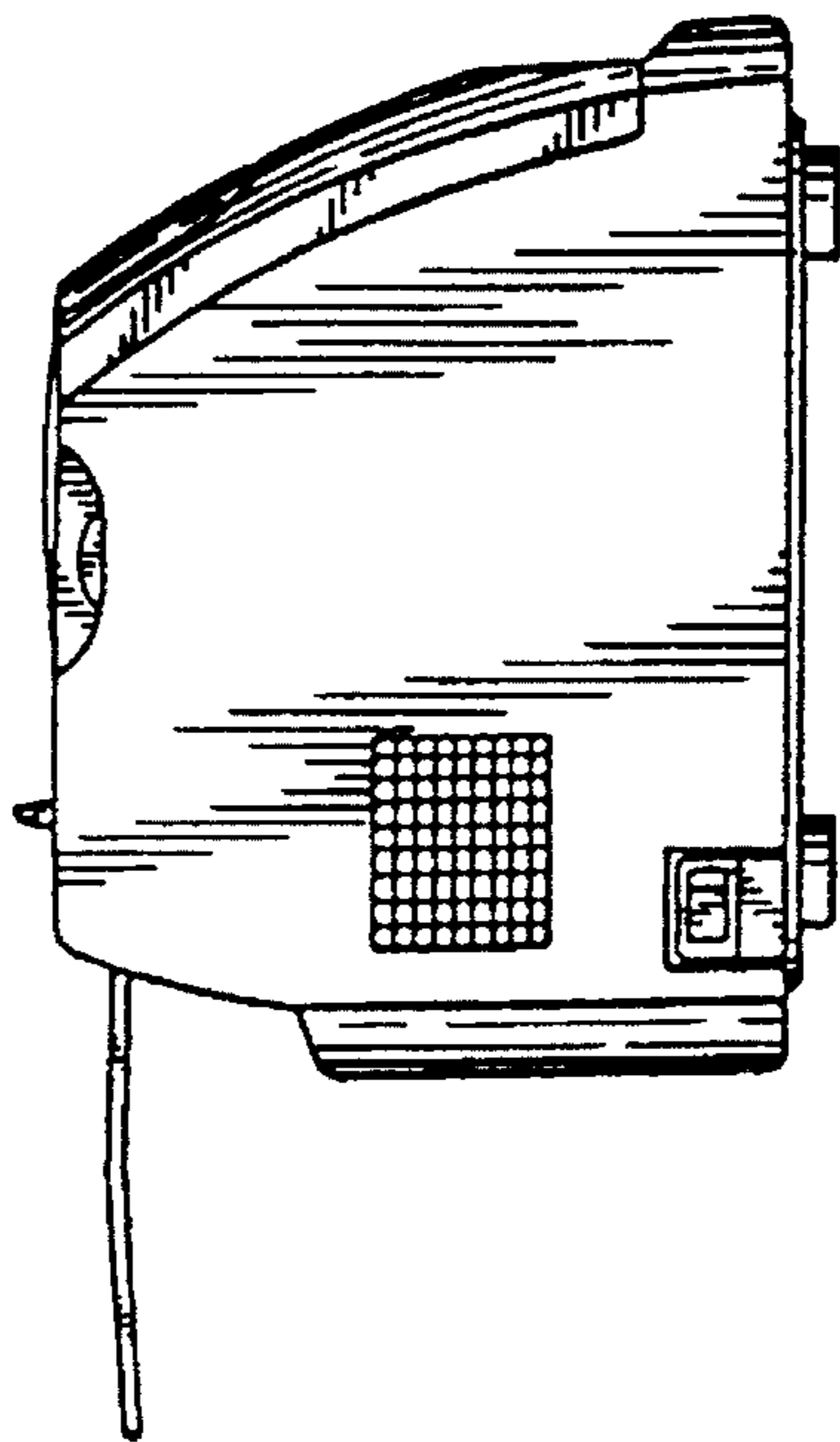

**FIG. 7**

