



US00D369126S

# United States Patent [19]

[11] Patent Number: **Des. 369,126**

Weder et al.

[45] Date of Patent: **\*\*\* Apr. 23, 1996**

[54] FLOWER POT COVER

4,712,725 12/1987 Moore ..... 229/8  
5,076,011 12/1991 Stehouwer ..... 47/72

[75] Inventors: **Donald E. Weder; Joseph G. Straeter,**  
both of Highland, Ill.

### FOREIGN PATENT DOCUMENTS

[73] Assignee: **Highland Supply Corporation,**  
Highland, Ill.

2489126 3/1982 France .  
2603159 4/1988 France .

### OTHER PUBLICATIONS

[\*] Notice: The portion of the term of this patent  
subsequent to Nov. 14, 2009, has been  
disclaimed.

Exhibit A-Speed Cover® Brochure-The Simple Solution .  
. . . , ©1989.

[\*\*] Term: **14 Years**

*Primary Examiner*—Jeffrey Asch  
*Attorney, Agent, or Firm*—Dunlap & Codding

[21] Appl. No.: **6,099**

### [57] CLAIM

[22] Filed: **Mar. 19, 1993**

The ornamental design for a flower pot cover, as shown and  
described.

### Related U.S. Application Data

### DESCRIPTION

[63] Continuation-in-part of Ser. No. 782,237, Oct. 18, 1991, Pat.  
No. Des. 349,076, which is a continuation-in-part of Ser. No.  
617,454, Nov. 2, 1990, abandoned, Ser. No. 411,249, Sep.  
22, 1989, Pat. No. Des. 358,113, Ser. No. 411,247, Sep. 22,  
1989, and Ser. No. 411,245, Sep. 22, 1989.

FIG. 1 is a perspective view of our new flower pot cover  
design;

[52] U.S. Cl. .... **D11/164; D11/143**

FIG. 2 is a side elevational view thereof;

[58] Field of Search ..... D11/143, 149,  
D11/152-156, 164, 89, 90; 47/66, 72; 206/423;  
215/100.5; 229/1.5 R, 1.5 B, 4.5, 87.01,  
922, 930, 108, 108.1, 109, 110; 428/27,  
35.1, 24, 542.6; D9/346, 428-431; D27/102,  
133; D26/128-136; D19/96; D7/540, 584,  
586, 587, 354

FIG. 3 is a top plan view thereof;

FIG. 4 is a bottom plan view thereof;

FIG. 5 is a side elevational view of the design of FIG. 1, the  
only difference being in the horizontal angle of the skirt;

FIG. 6 is a side elevational view of the design of FIG. 1, the  
only difference being in the near vertical angle of the skirt;

FIG. 7 is a side elevational view of the design of FIG. 1, the  
only difference being in the downward angle of the skirt;

FIG. 8 is a side elevational view of a second embodiment of  
the design of FIG. 1, the only difference being in the height  
of the base;

FIG. 9 is a side elevational view of a third embodiment of  
the design of FIG. 1, the only difference being in the height  
of the base;

FIG. 10 is a top plan view of a fourth embodiment of the  
design of FIG. 1, the only difference being in the size of the  
skirt;

FIG. 11 is a top plan view of a fifth embodiment of the  
design of FIG. 1, the only difference being in the size of the  
skirt;

FIG. 12 is a perspective view of a sixth embodiment of our  
new flower pot cover design;

FIG. 13 is a side elevational view thereof;

FIG. 14 is a top plan view thereof;

### [56] References Cited

#### U.S. PATENT DOCUMENTS

D. 239,192	3/1976	Wiles et al. ....	D35/3 A
D. 254,659	4/1980	Karotseris ....	D11/143
D. 319,417	8/1991	Weder et al. ....	D11/164
D. 322,403	12/1991	Eaton ....	D9/429
D. 324,659	3/1992	Stehouwer ....	D11/164
D. 327,234	6/1992	Vaughn ....	D11/143
D. 349,076	7/1994	Weder et al. ....	D11/164
1,951,642	8/1932	Augustin et al. ....	47/32
2,355,559	8/1944	Renner ....	229/8
2,827,217	3/1958	Clement ....	229/1.5 R
3,443,741	5/1969	Stockdale ....	D9/431 X
4,043,077	8/1977	Stonehocker ....	47/36

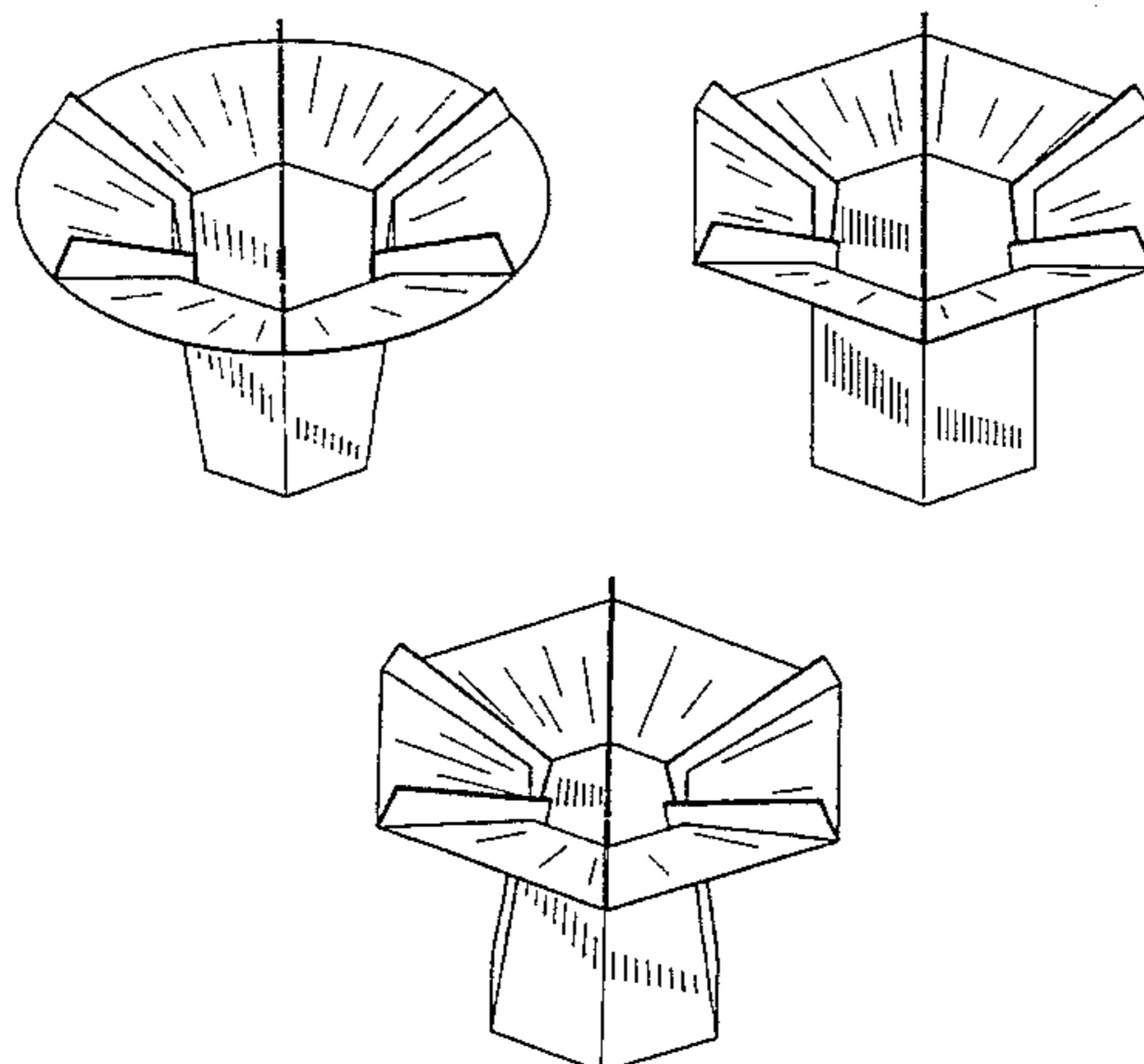

FIG. 15 is a bottom plan view thereof;  
FIG. 16 is a side elevational view of the design of FIG. 12, the only difference being in the horizontal angle of the skirt;  
FIG. 17 is a side elevational view of the design of FIG. 12, the only difference being in the near vertical angle of the skirt;  
FIG. 18 is a side elevational view of the design of FIG. 12, the only difference being in the downward angle of the skirt;  
FIG. 19 is a side elevational view of a seventh embodiment of the flower pot cover design of FIG. 12, the only difference being in the height of the base;  
FIG. 20 is a side elevational view of an eighth embodiment of the new flower pot cover design of FIG. 12 the only difference being in the height of the base;  
FIG. 21 is a top plan view of a ninth embodiment of the flower pot cover design, of FIG. 12 the only difference being in the size of the skirt;  
FIG. 22 is a top plan view of a tenth embodiment of the flower pot cover design, of FIG. 12 the only difference being in the size of the skirt;  
FIG. 23 is a perspective view of an eleventh embodiment of our new flower pot cover design;  
FIG. 24 is a side elevational view thereof;  
FIG. 25 is a top plan view thereof;  
FIG. 26 is a bottom plan view thereof;  
FIG. 27 is a side elevational view of the design of FIG. 23, the only difference being in the horizontal angle of the skirt;  
FIG. 28 is a side elevational view of the design of FIG. 23, the only difference being in the near vertical angle of the skirt;  
FIG. 29 is a side elevational view of the design of FIG. 23, the only difference being in the downward angle of the skirt;  
FIG. 30 is a side elevational view of a twelfth embodiment of the flower pot cover design of FIG. 23, the only difference being in the height of the base;  
FIG. 31 is a side elevational view of a thirteenth embodiment of the new flower pot cover design of FIG. 23, the only difference being in the height of the base;  
FIG. 32 is a top plan view of a fourteenth embodiment of the flower pot cover design of FIG. 23, the only difference being in the size of the skirt;  
FIG. 33 is a top plan view of a fifteenth embodiment of the flower pot cover design of FIG. 23, the only difference being in the size of the skirt;  
FIG. 34 is a perspective view of a sixteenth embodiment of our new flower pot cover design;  
FIG. 35 is a side elevational view thereof;  
FIG. 36 is a top plan view thereof;  
FIG. 37 is a bottom plan view thereof;  
FIG. 38 is a side elevational view of the design of FIG. 34, the only difference being in the horizontal angle of the skirt;  
FIG. 39 is a side elevational view of the design of FIG. 34, the only difference being in the near vertical angle of the skirt;  
FIG. 40 is a side elevational view of the design of FIG. 34, the only difference being in the downward angle of the skirt;  
FIG. 41 is a side elevational view of a seventeenth embodiment of the flower pot cover design of FIG. 34, the only difference being in the height of the base;  
FIG. 42 is a side elevational view of an eighteenth embodi-

ment of the new flower pot cover design of FIG. 34, the only difference being in the height of the base;  
FIG. 43 is a top plan view of a nineteenth embodiment of the flower pot cover design of FIG. 34, the only difference being in the size of the skirt;  
FIG. 44 is a top plan view of a twentieth embodiment of the flower pot cover design of FIG. 34, the only difference being in the size of the skirt;  
FIG. 45 is a perspective view of a twenty-first embodiment of our new flower pot cover design;  
FIG. 46 is a side elevational view thereof;  
FIG. 47 is a top plan view thereof;  
FIG. 48 is a bottom plan view thereof;  
FIG. 49 is a side elevational view of the design of FIG. 45, the only difference being in the horizontal angle of the skirt;  
FIG. 50 is a side elevational view of the design of FIG. 45, the only difference being in the near vertical angle of the skirt;  
FIG. 51 is a side elevational view of the design of FIG. 45, the only difference being in the downward angle of the skirt;  
FIG. 52 is a side elevational view of a twenty-second embodiment of the flower pot cover design of FIG. 45, the only difference being in the height of the base;  
FIG. 53 is a side elevational view of a twenty-third embodiment of the new flower pot cover design of FIG. 45, the only difference being in the height of the base;  
FIG. 54 is a top plan view of a twenty-fourth embodiment of the flower pot cover design of FIG. 45, the only difference being in the size of the skirt;  
FIG. 55 is a top plan view of a twenty-fifth embodiment of the flower pot cover design of FIG. 45, the only difference being in the size of the skirt;  
FIG. 56 is a perspective view of a twenty-sixth embodiment of our new flower pot cover design;  
FIG. 57 is a side elevational view thereof;  
FIG. 58 is a top plan view thereof;  
FIG. 59 is a bottom plan view thereof;  
FIG. 60 is a side elevational view of the design of FIG. 56, the only difference being in the horizontal angle of the skirt;  
FIG. 61 is a side elevational view of the design of FIG. 56, the only difference being in the rear vertical angle of the skirt;  
FIG. 62 is a side elevational view of the design of FIG. 56, the only difference being in the downward angle of the skirt;  
FIG. 63 is a side elevational view of a twenty-seventh embodiment of the flower pot cover design of FIG. 56, the only difference being in the height of the base;  
FIG. 64 is a side elevational view of a twenty-eighth embodiment of the new flower pot cover design of FIG. 56, the only difference being in the height of the base;  
FIG. 65 is a top plan view of a twenty-ninth embodiment of the flower pot cover design of FIG. 56, the only difference being in the size of the skirt; and,  
FIG. 66 is a top plan view of a thirtieth embodiment of the flower pot cover design of FIG. 56, the only difference being in the size of the skirt.

The flower pot cover has no substantial thickness.

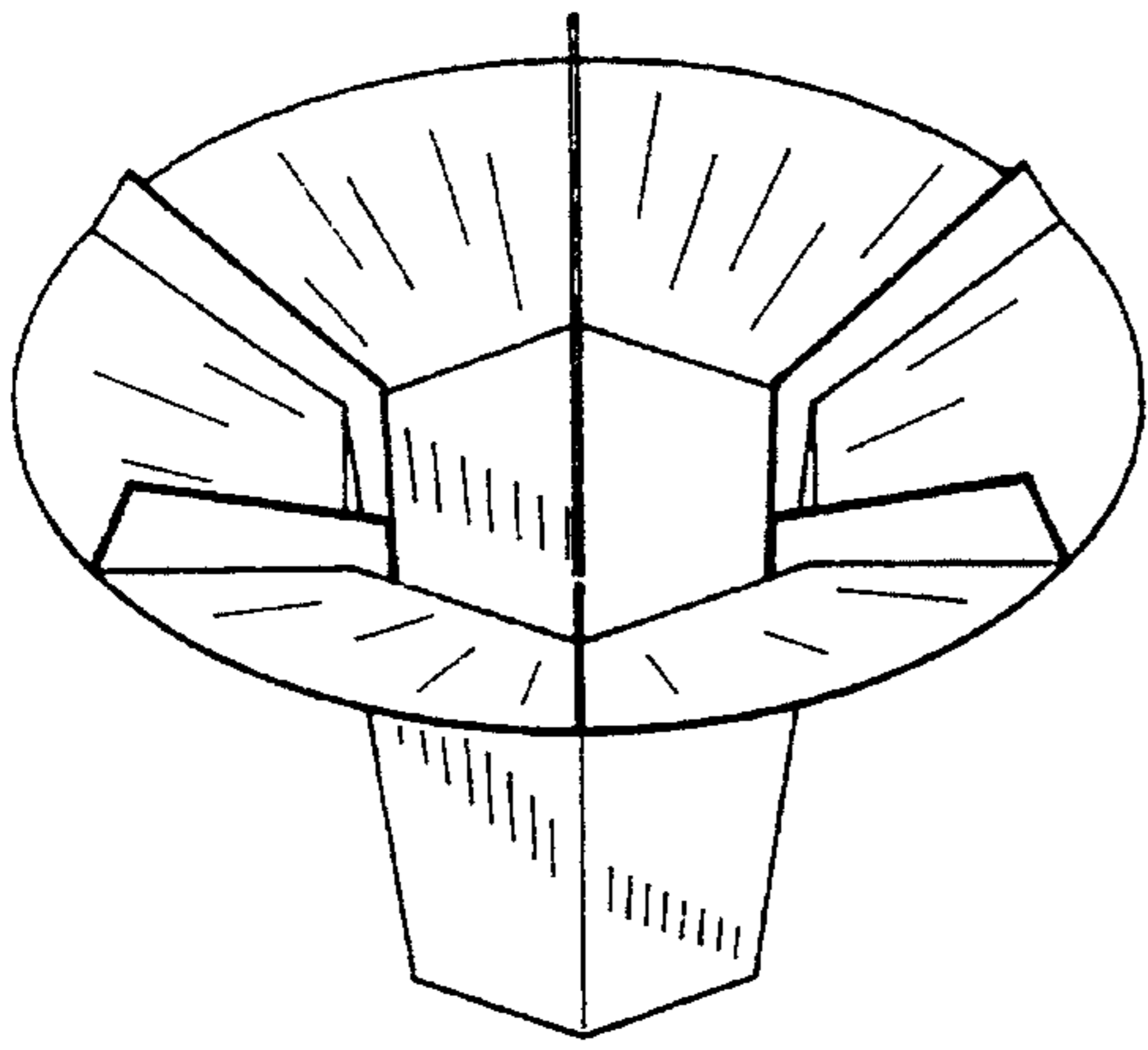

FIG. 1

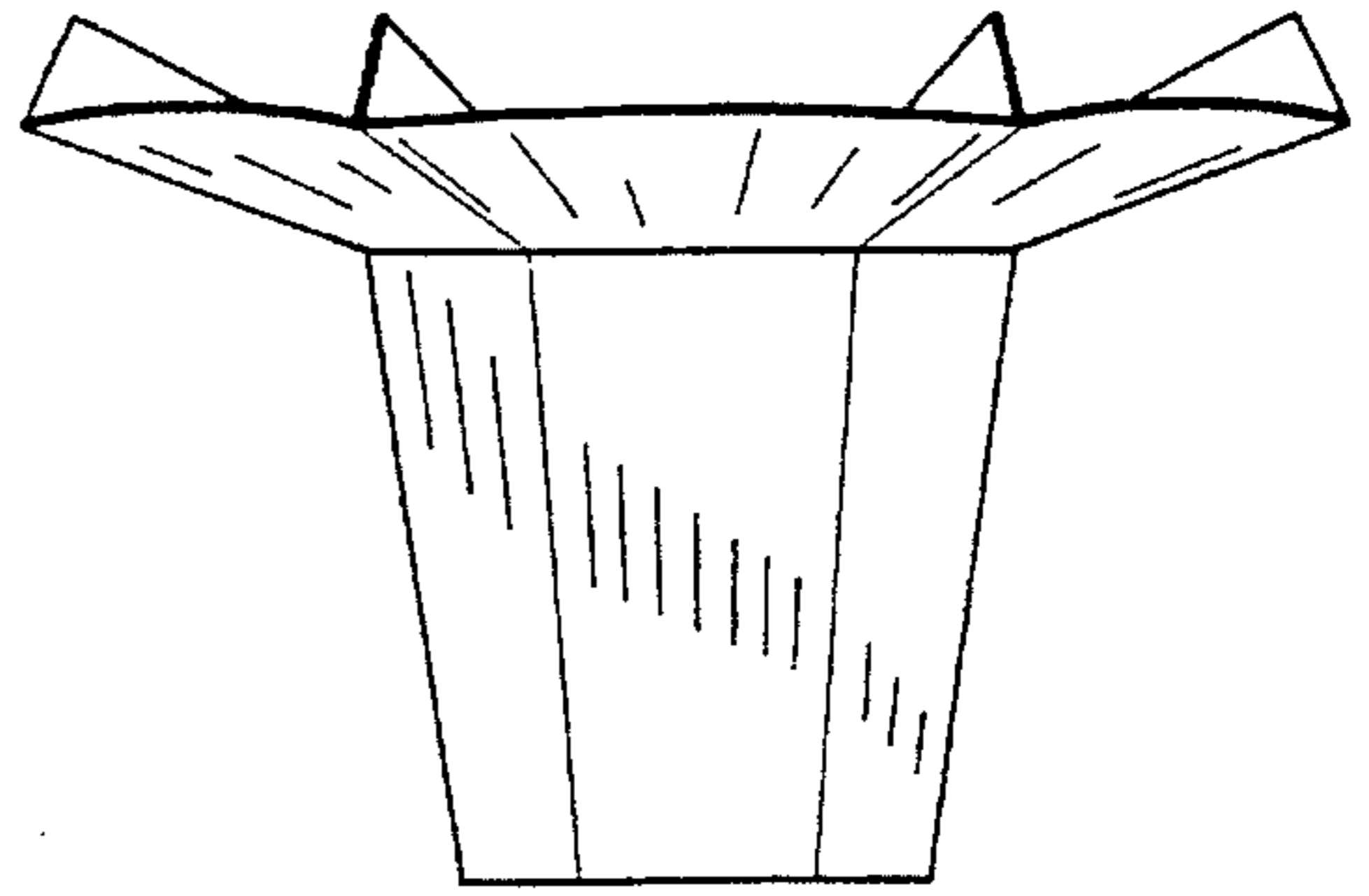

FIG. 2

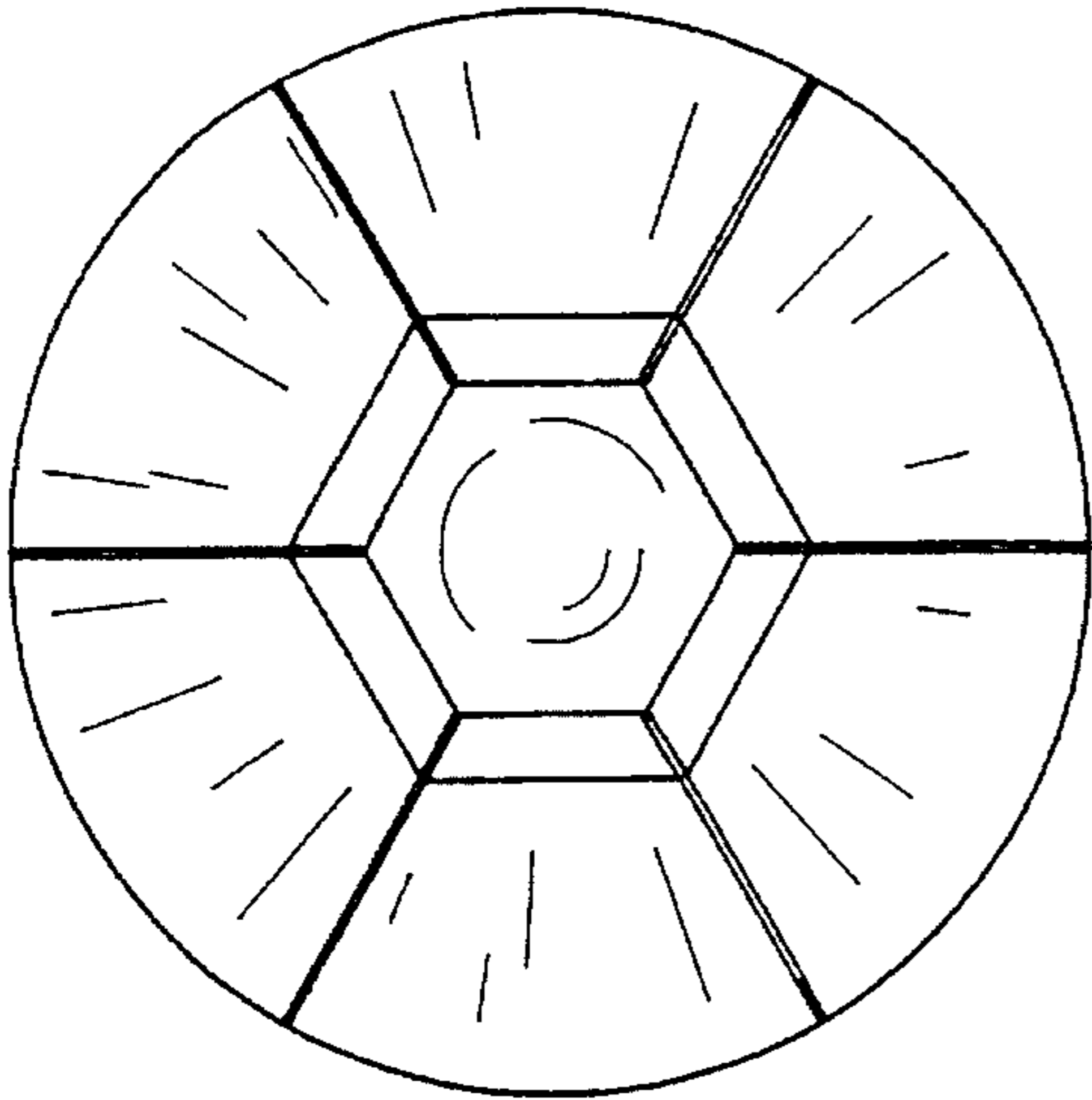

FIG. 3

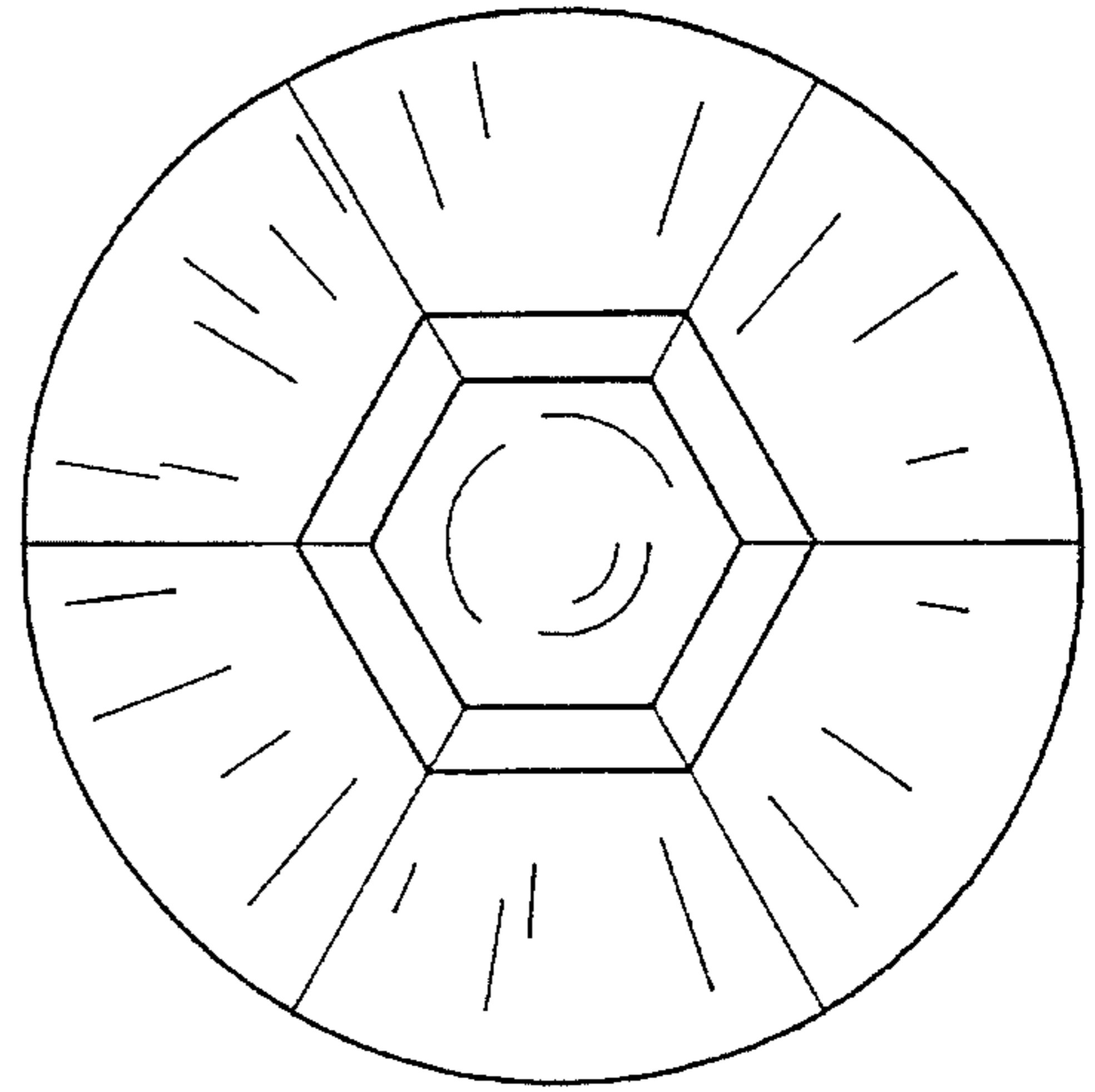

FIG. 4

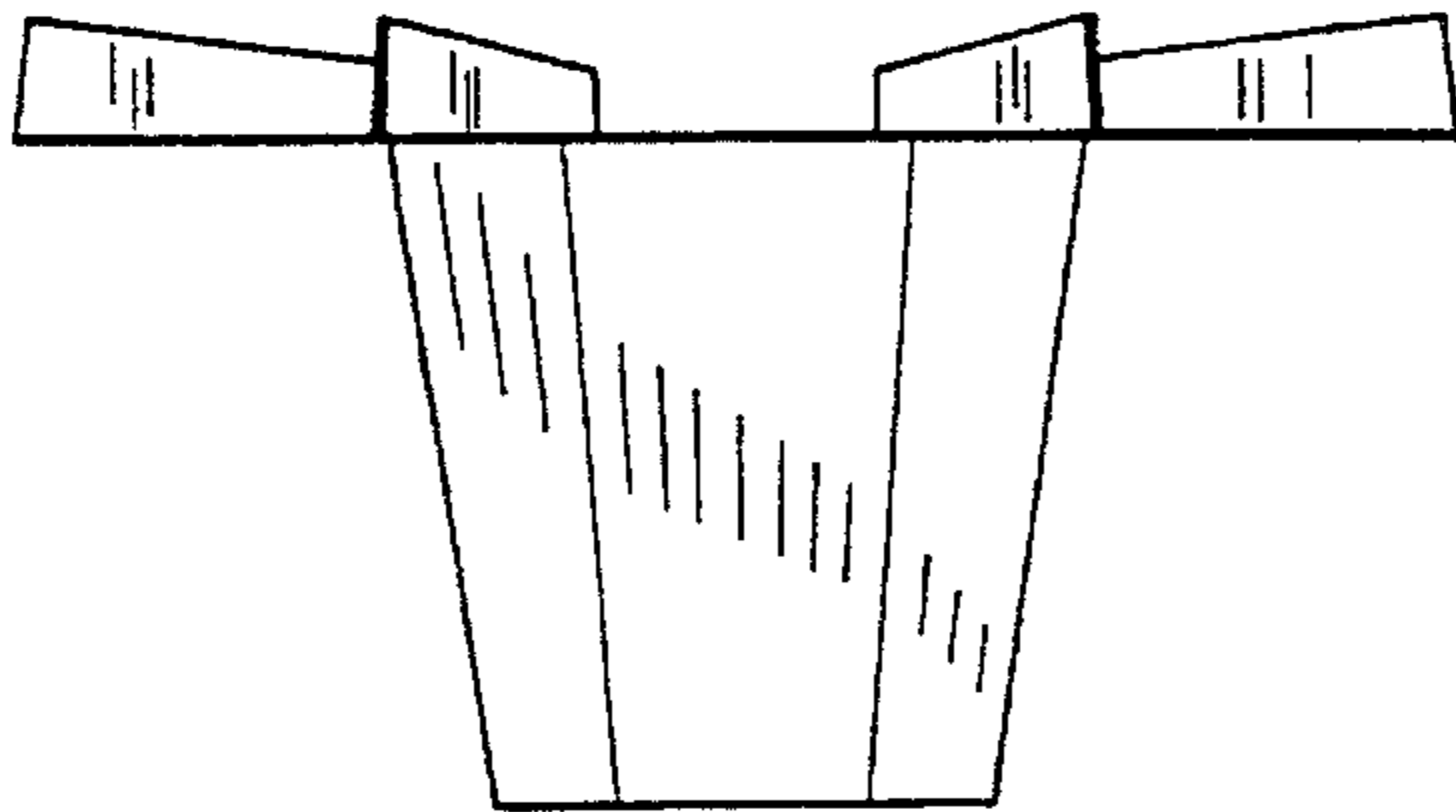

FIG. 5

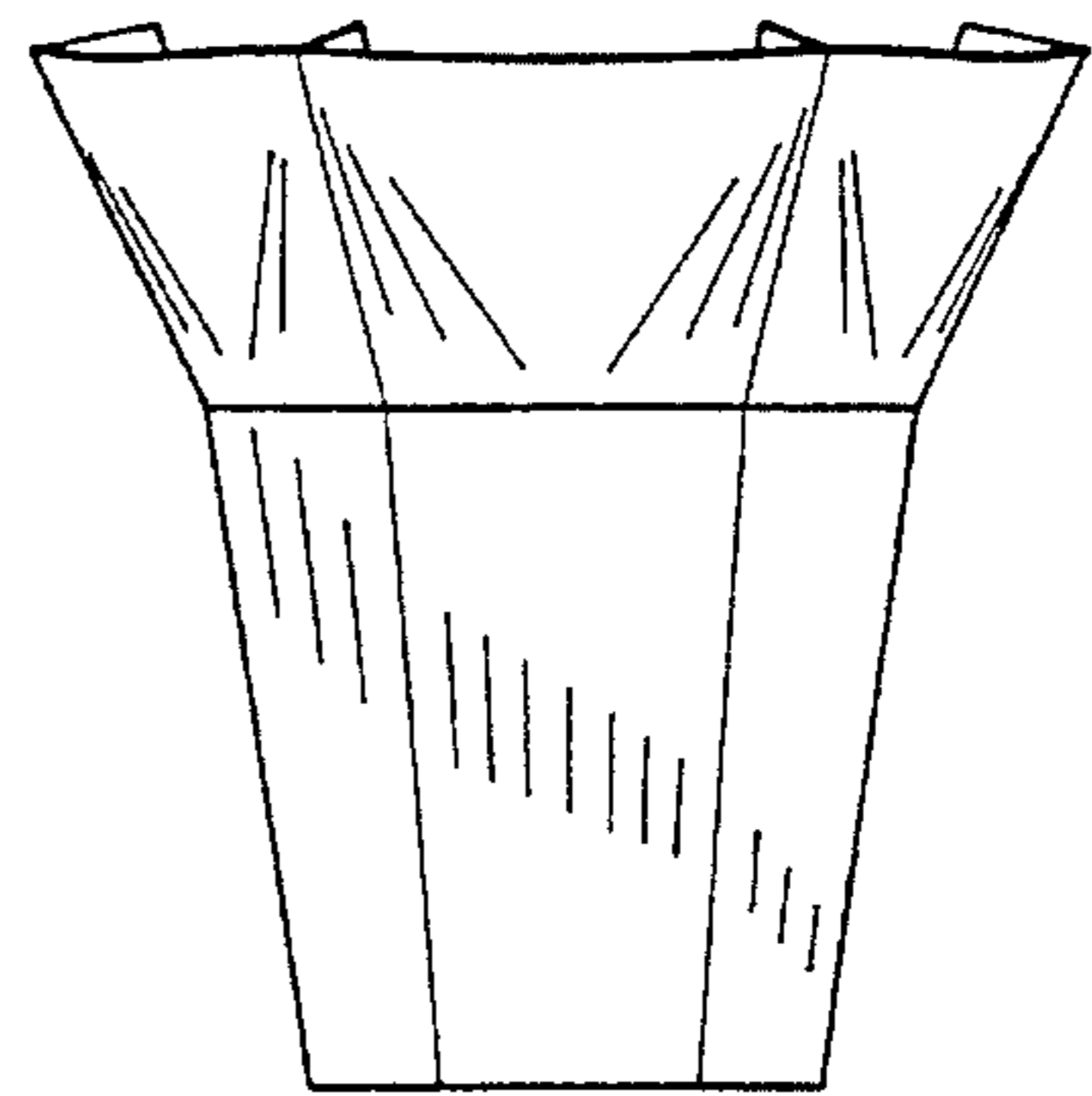

FIG. 6

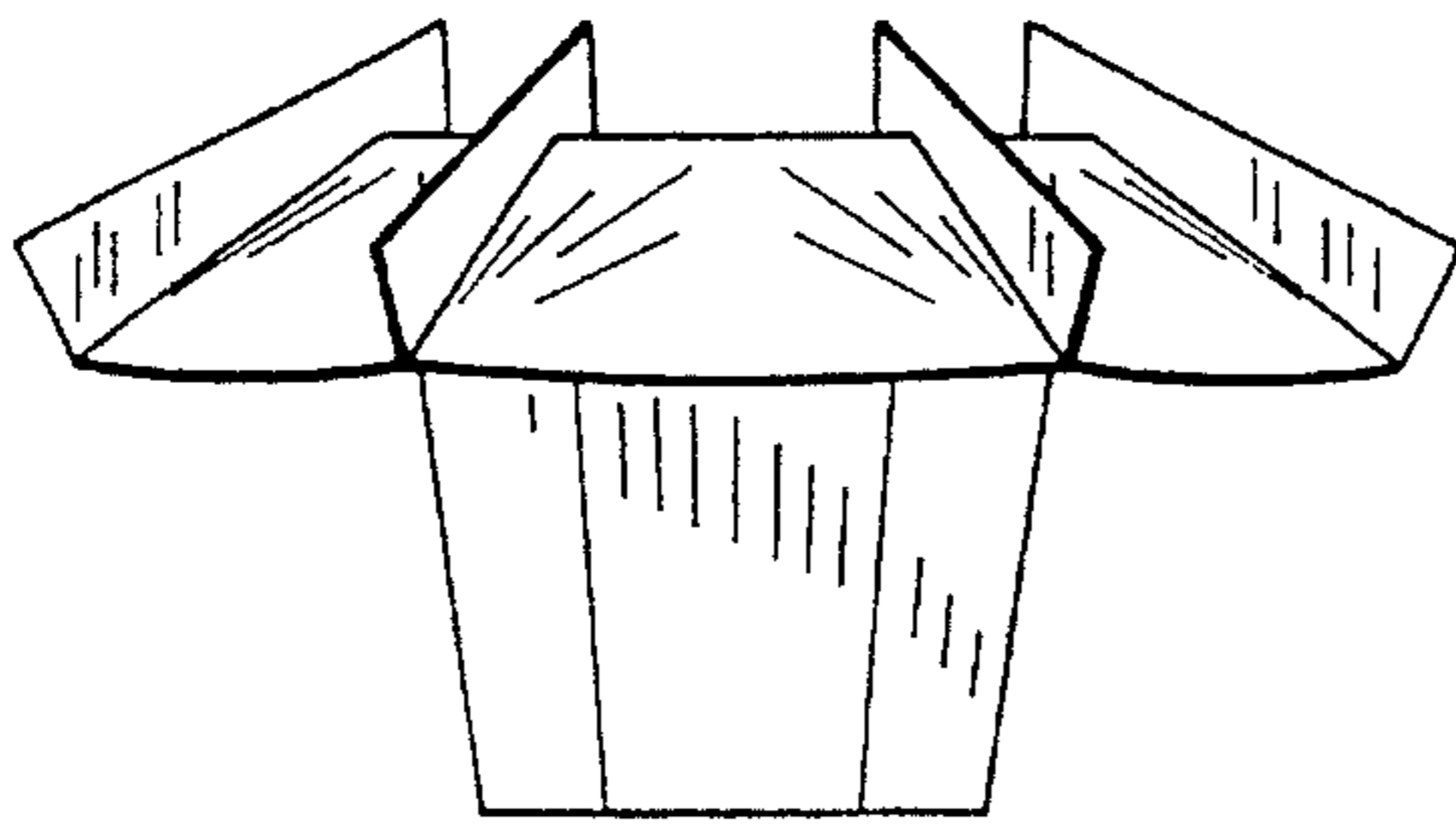

FIG. 7

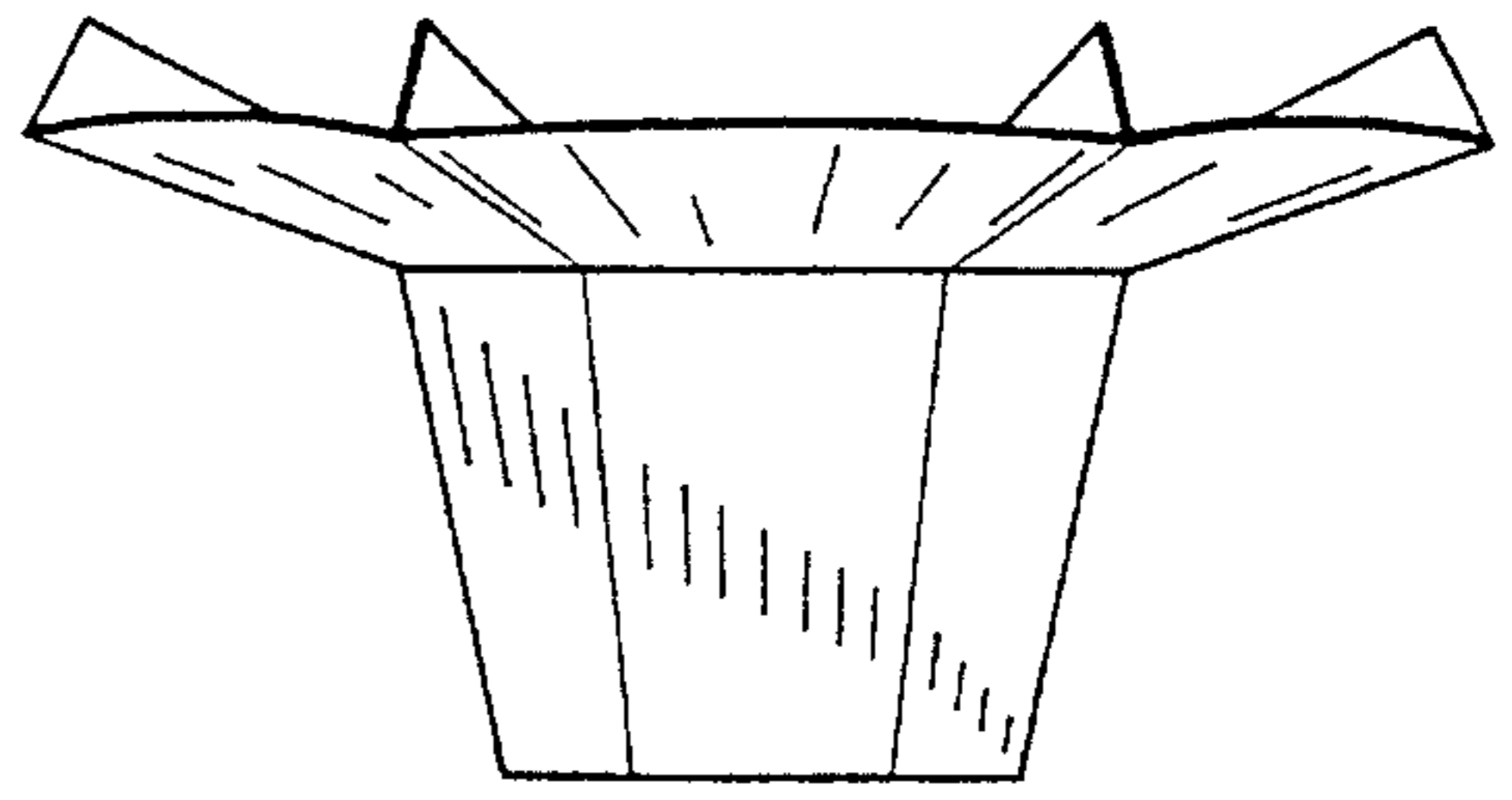

FIG. 8

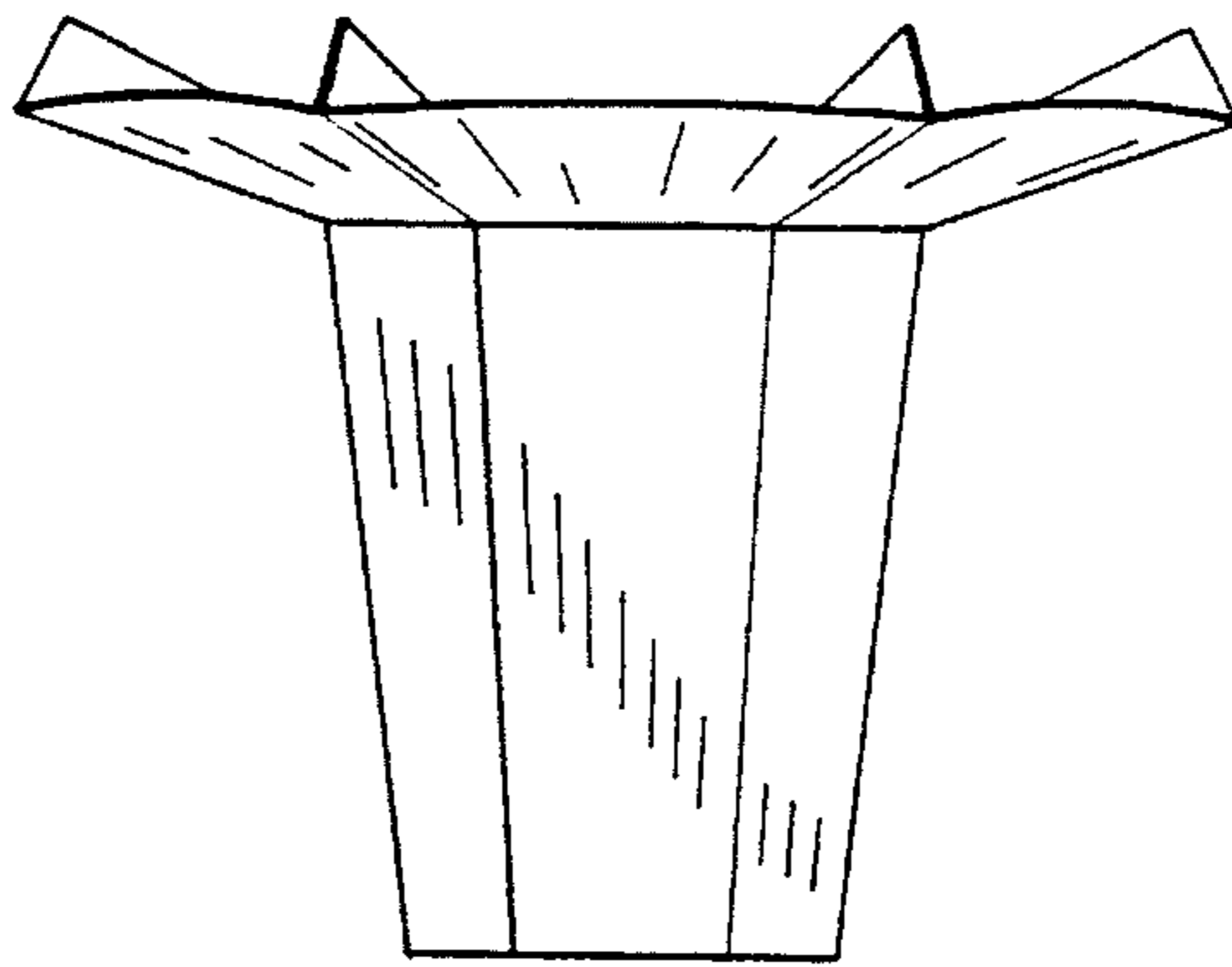

FIG. 9

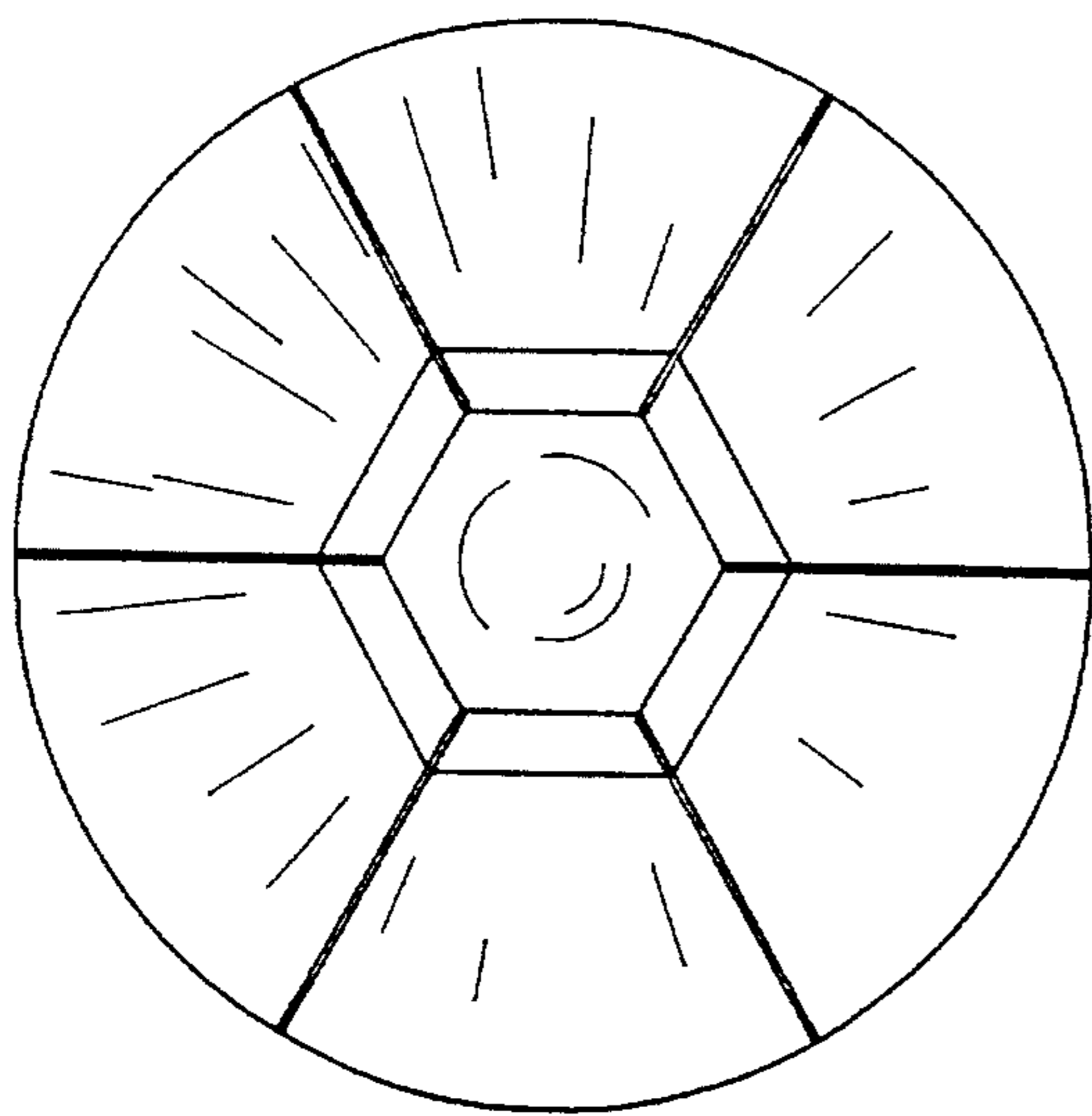

FIG. 10

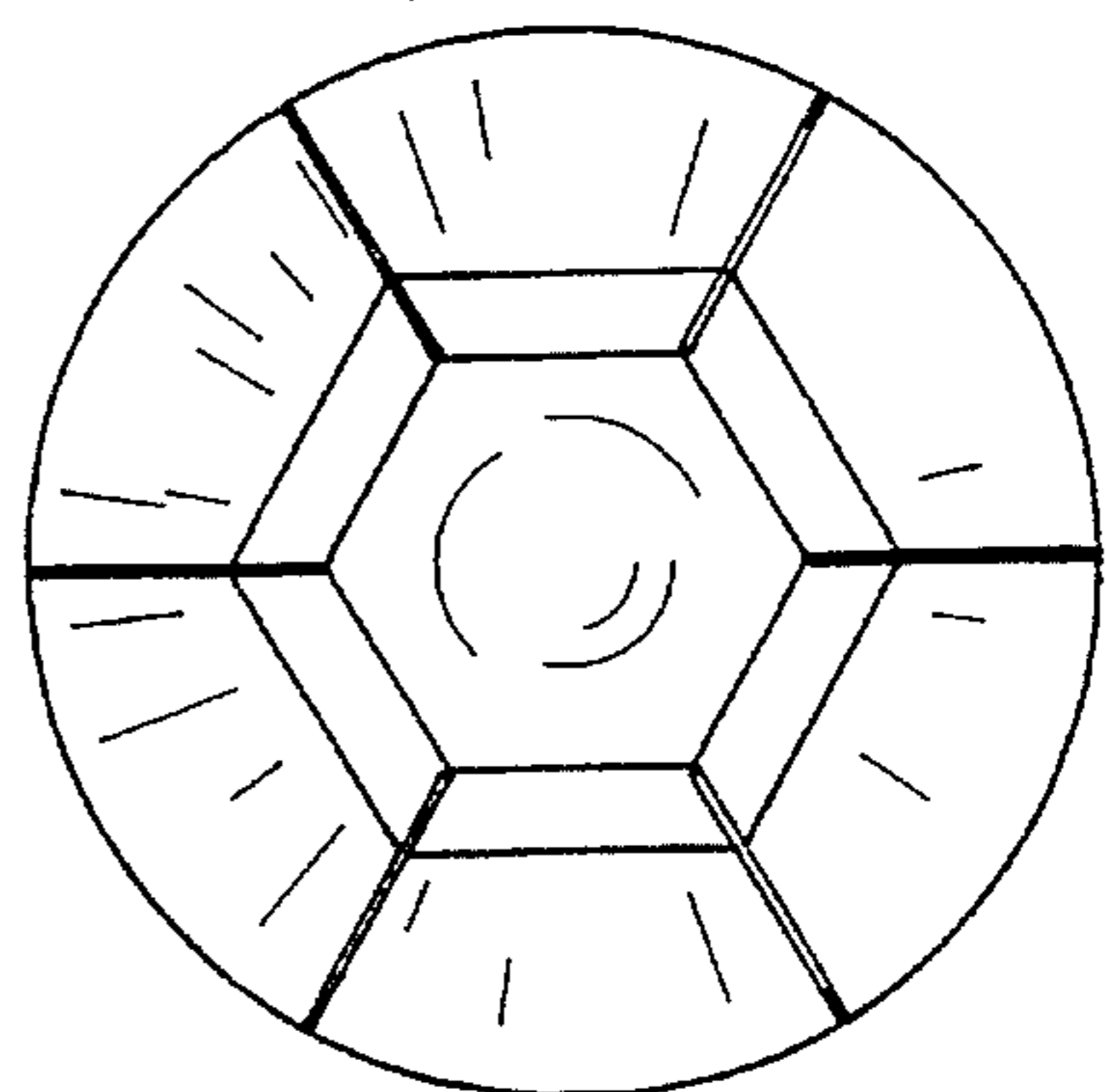

FIG. 11

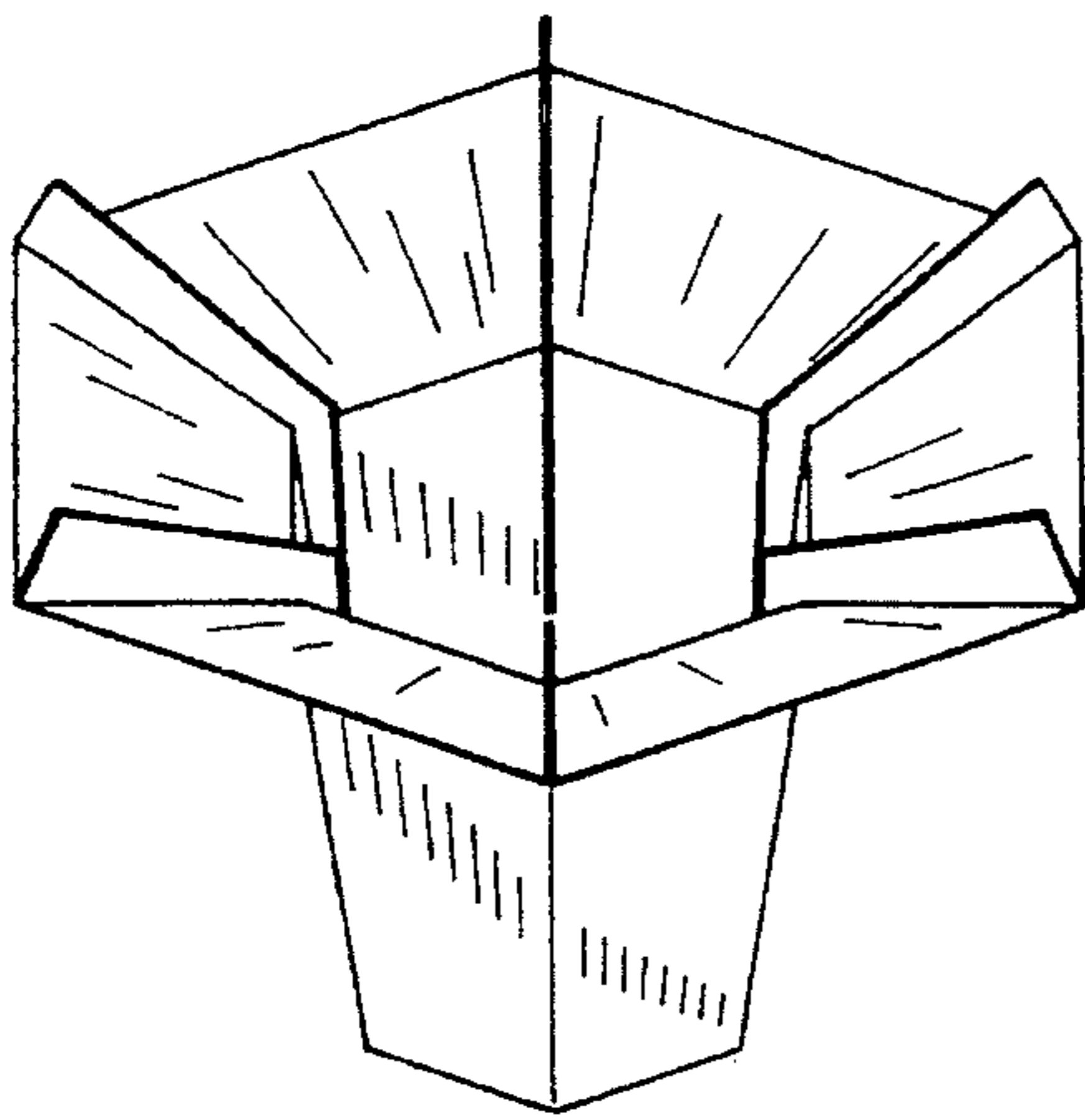

FIG. 11

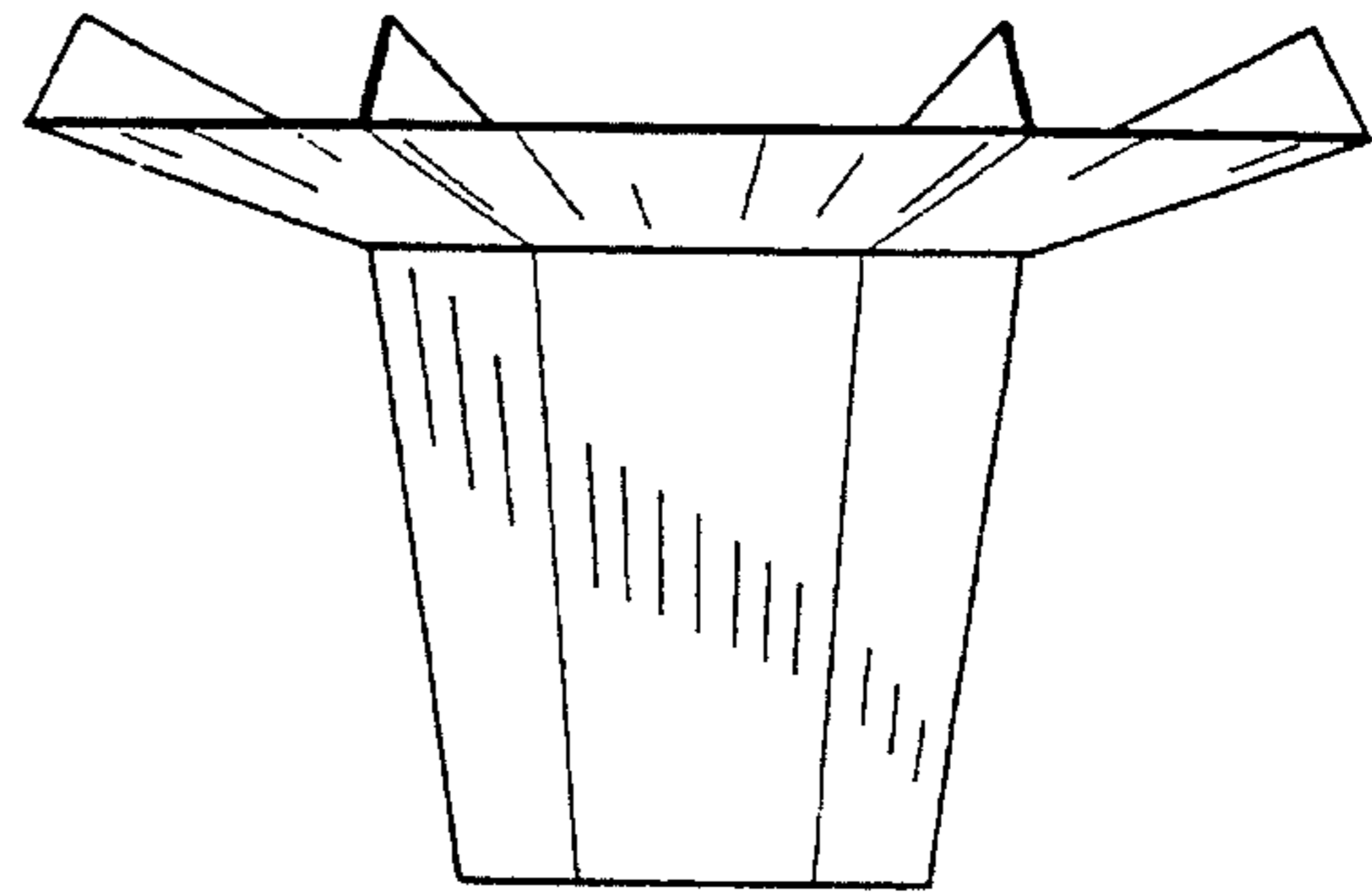

FIG. 12

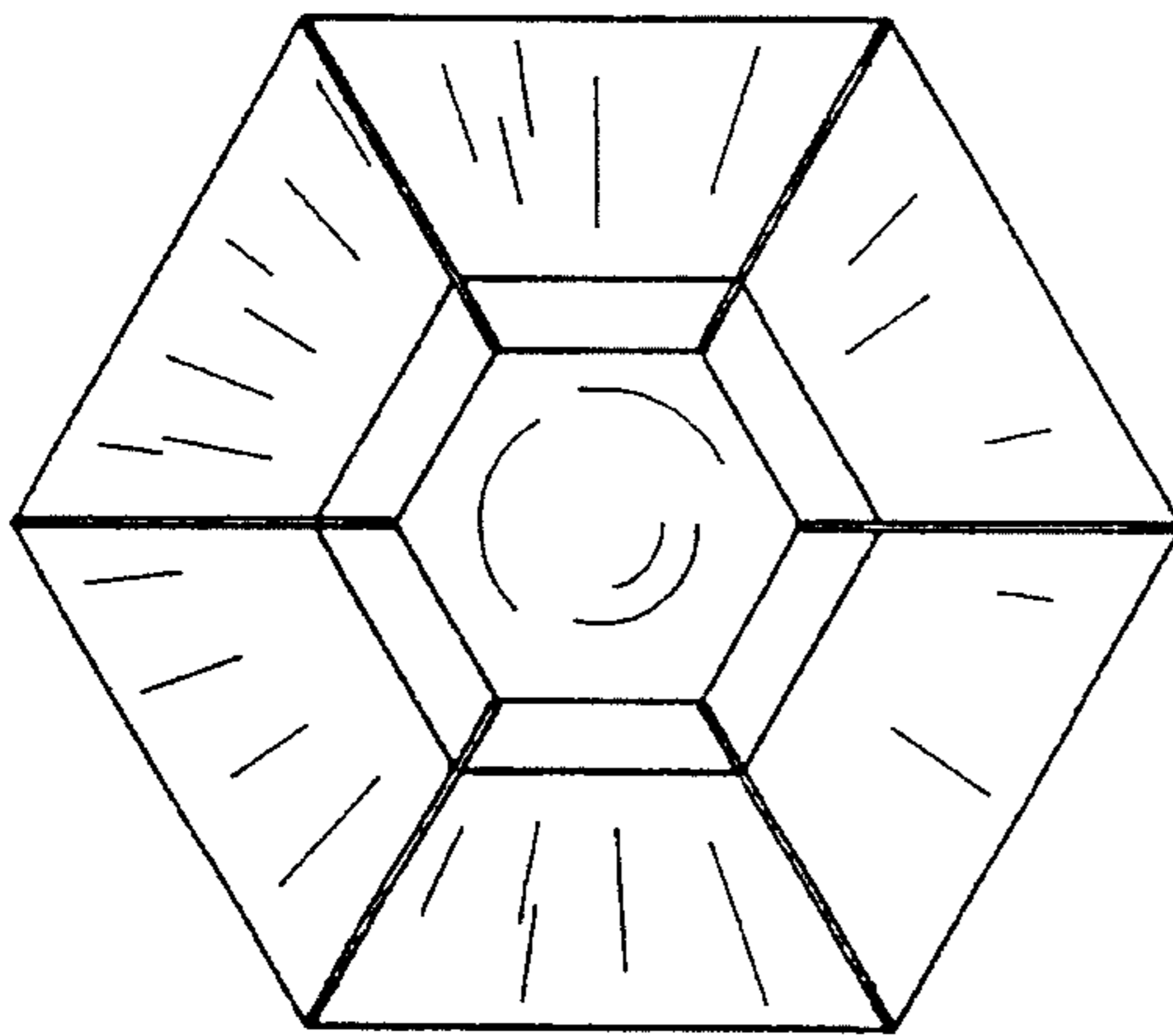

FIG. 14

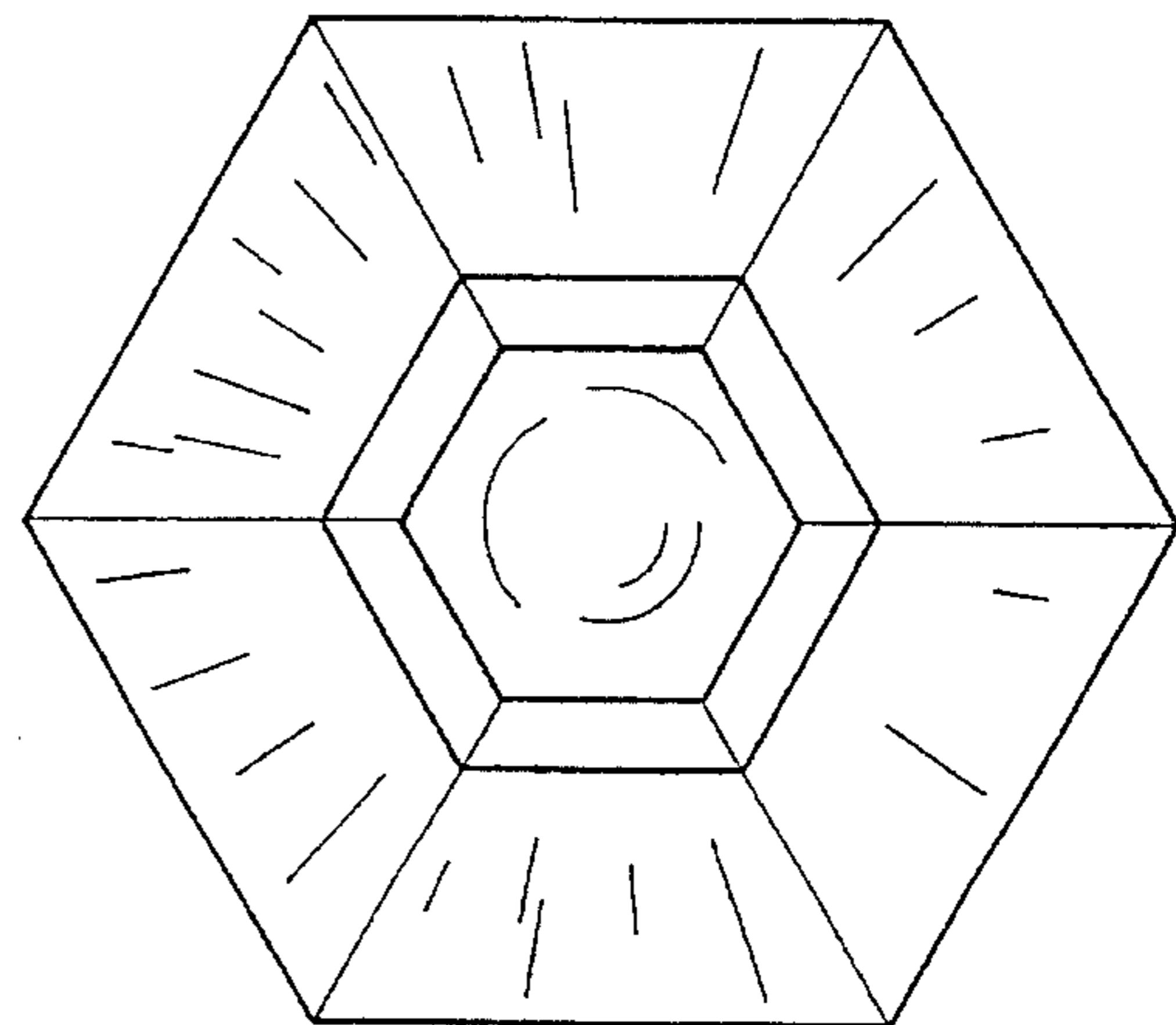

FIG. 15

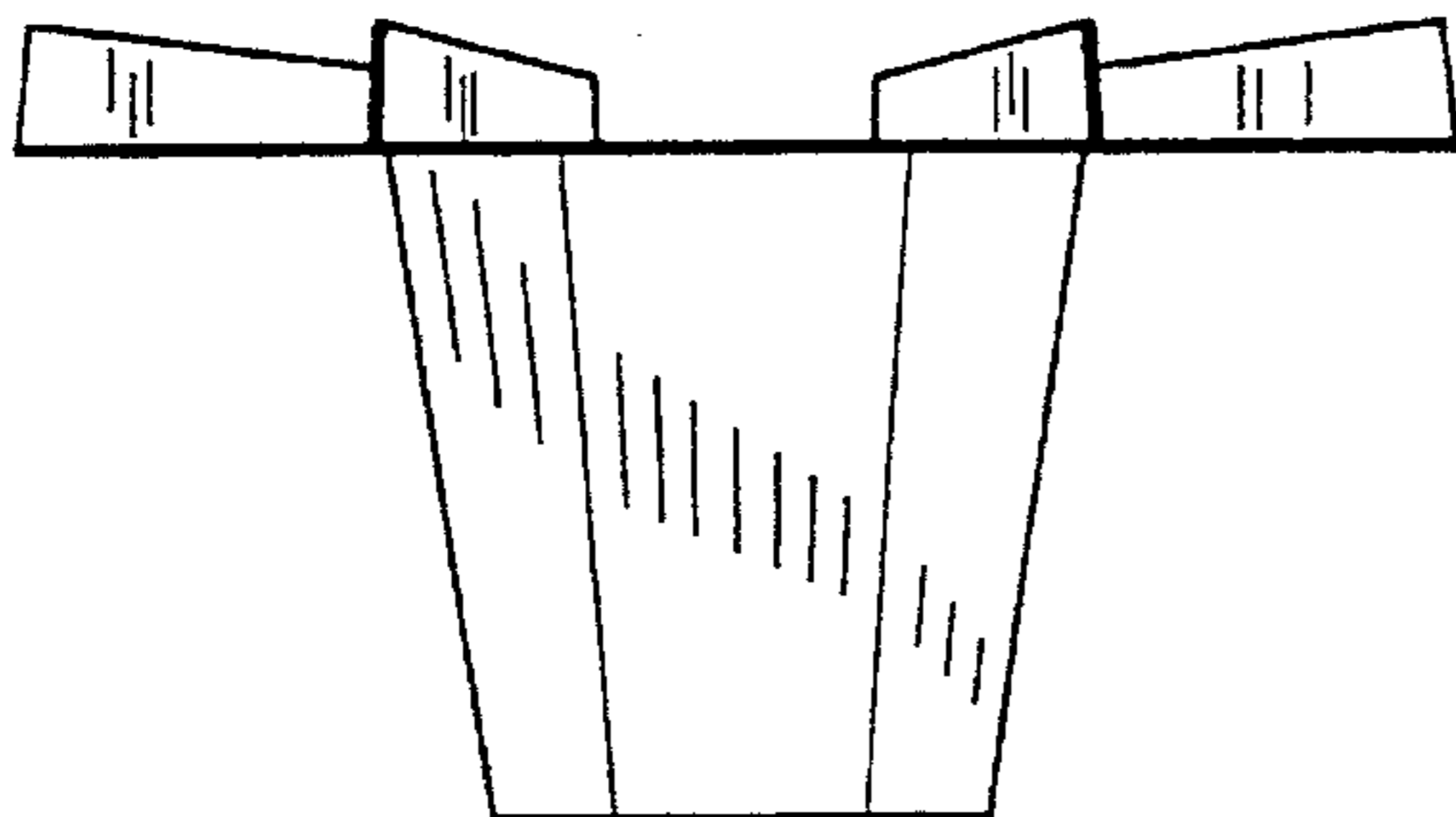

FIG. 16

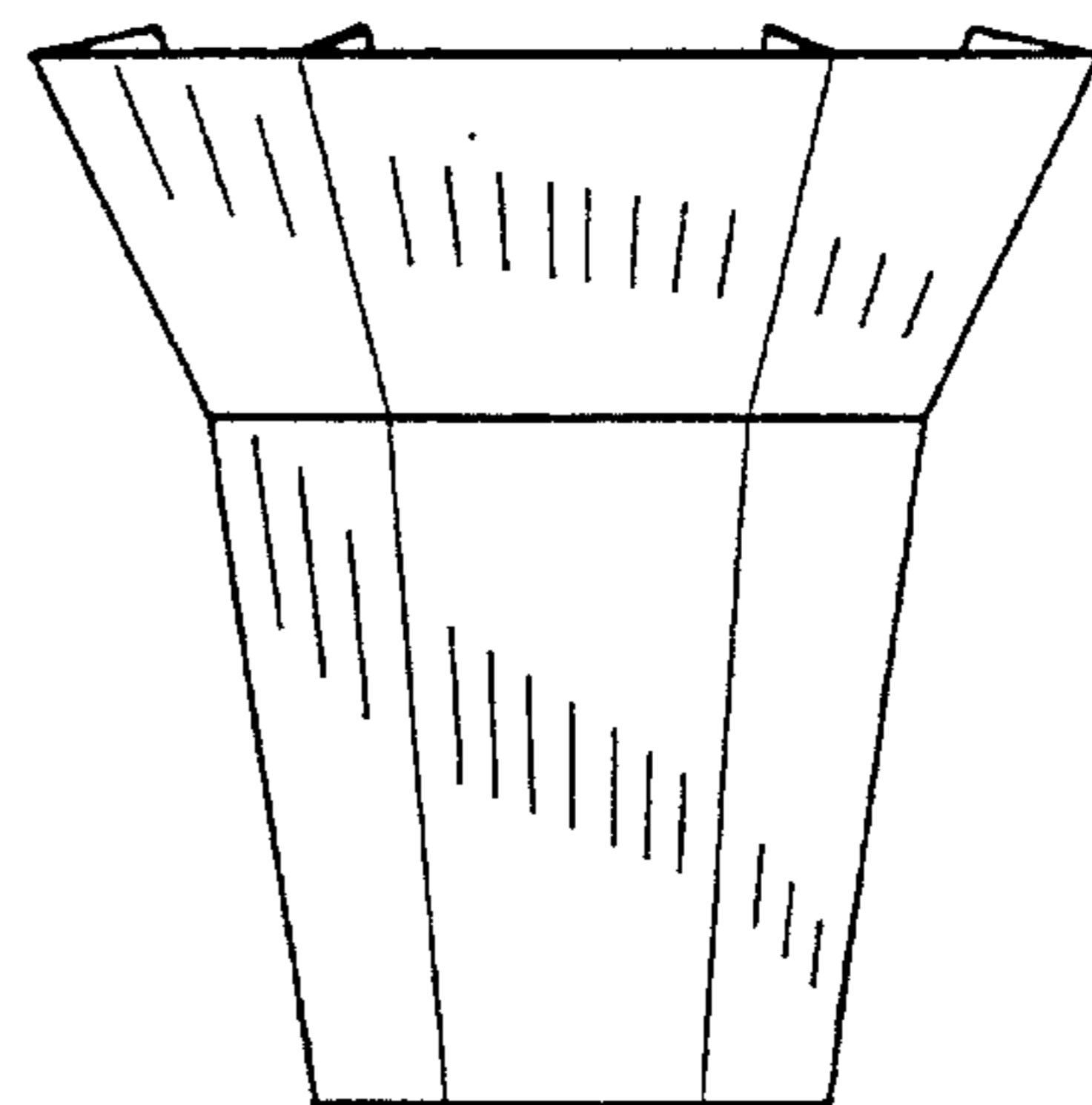

FIG. 17

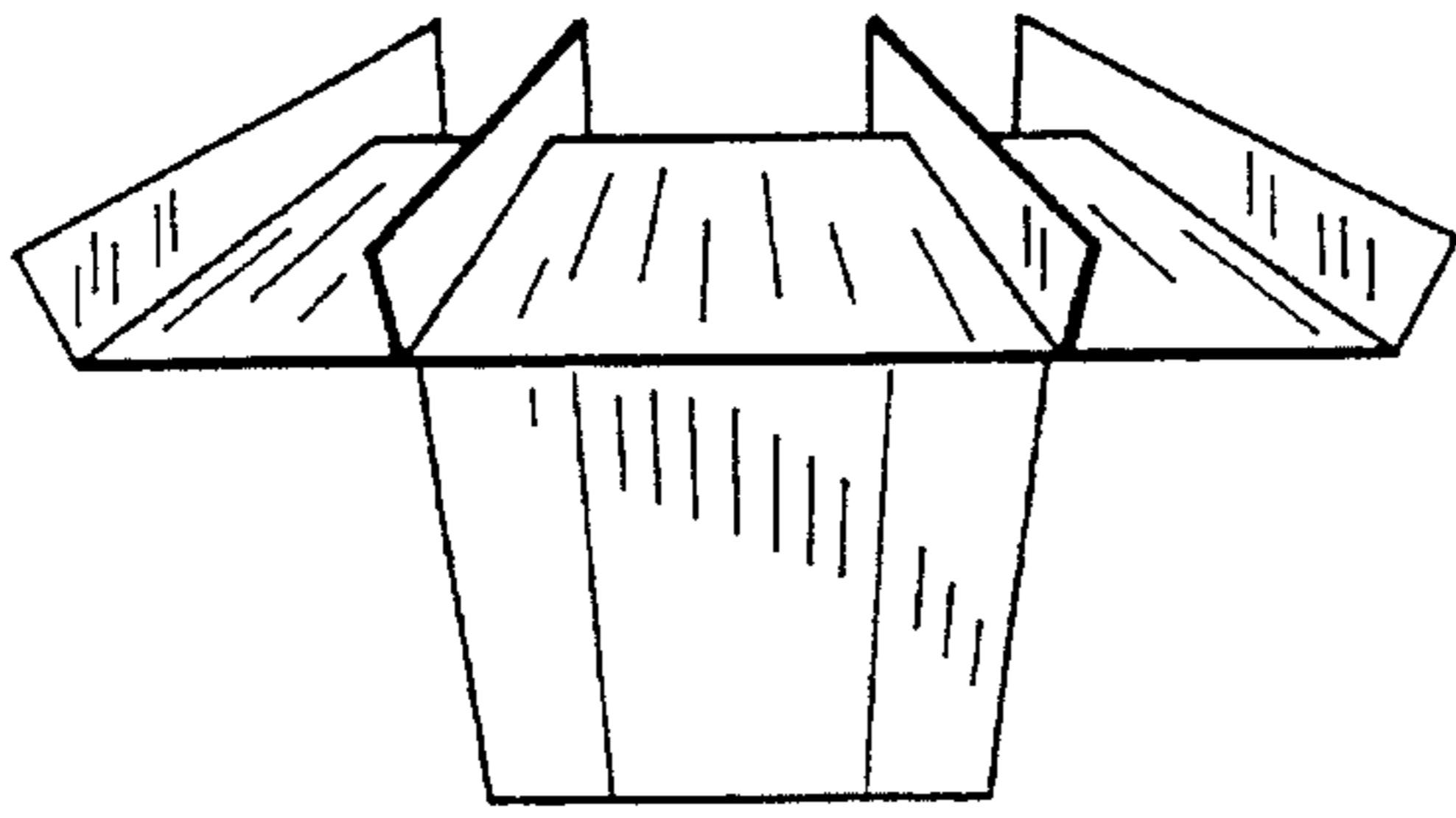

FIG. 18

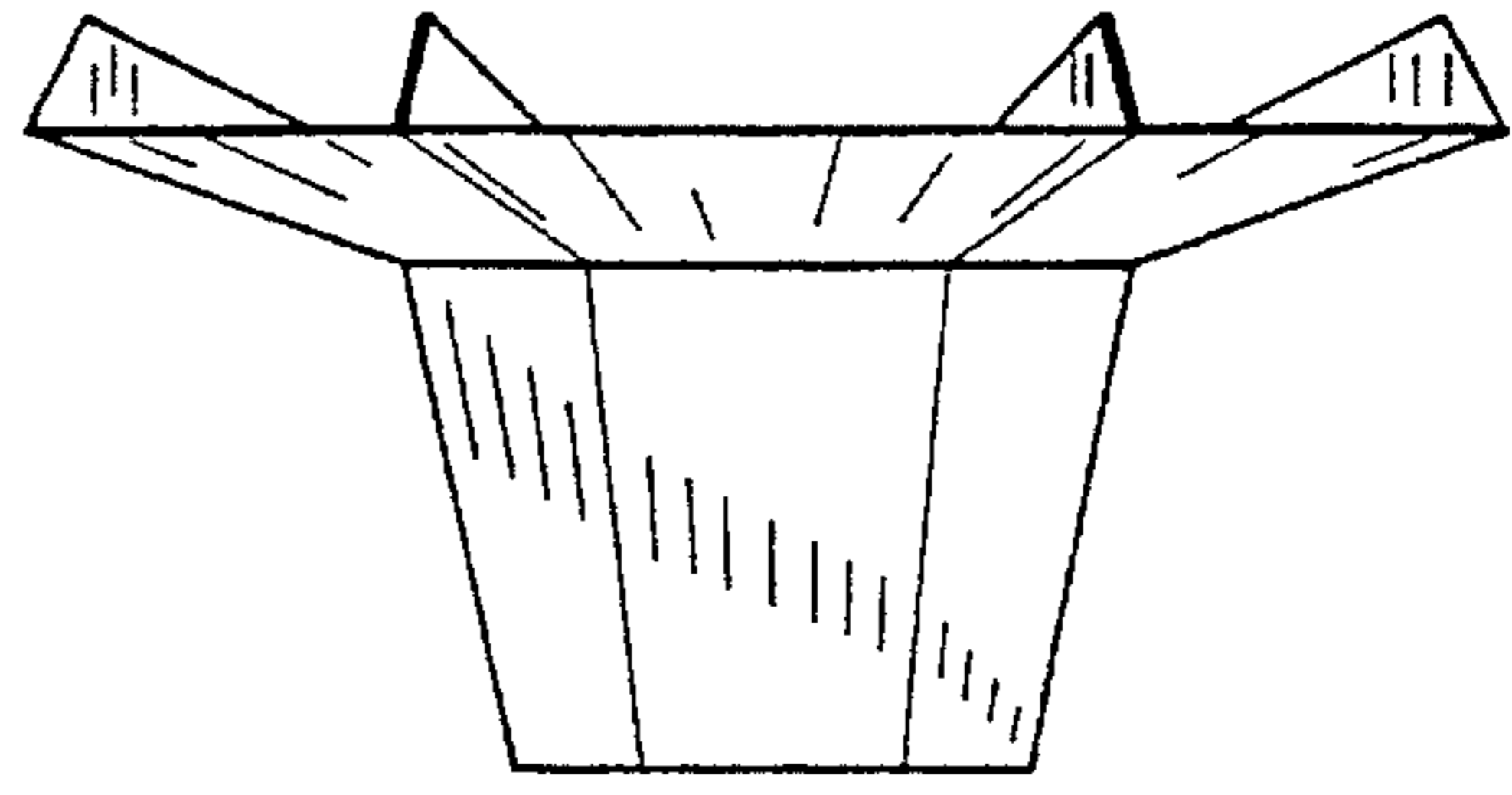

FIG. 19

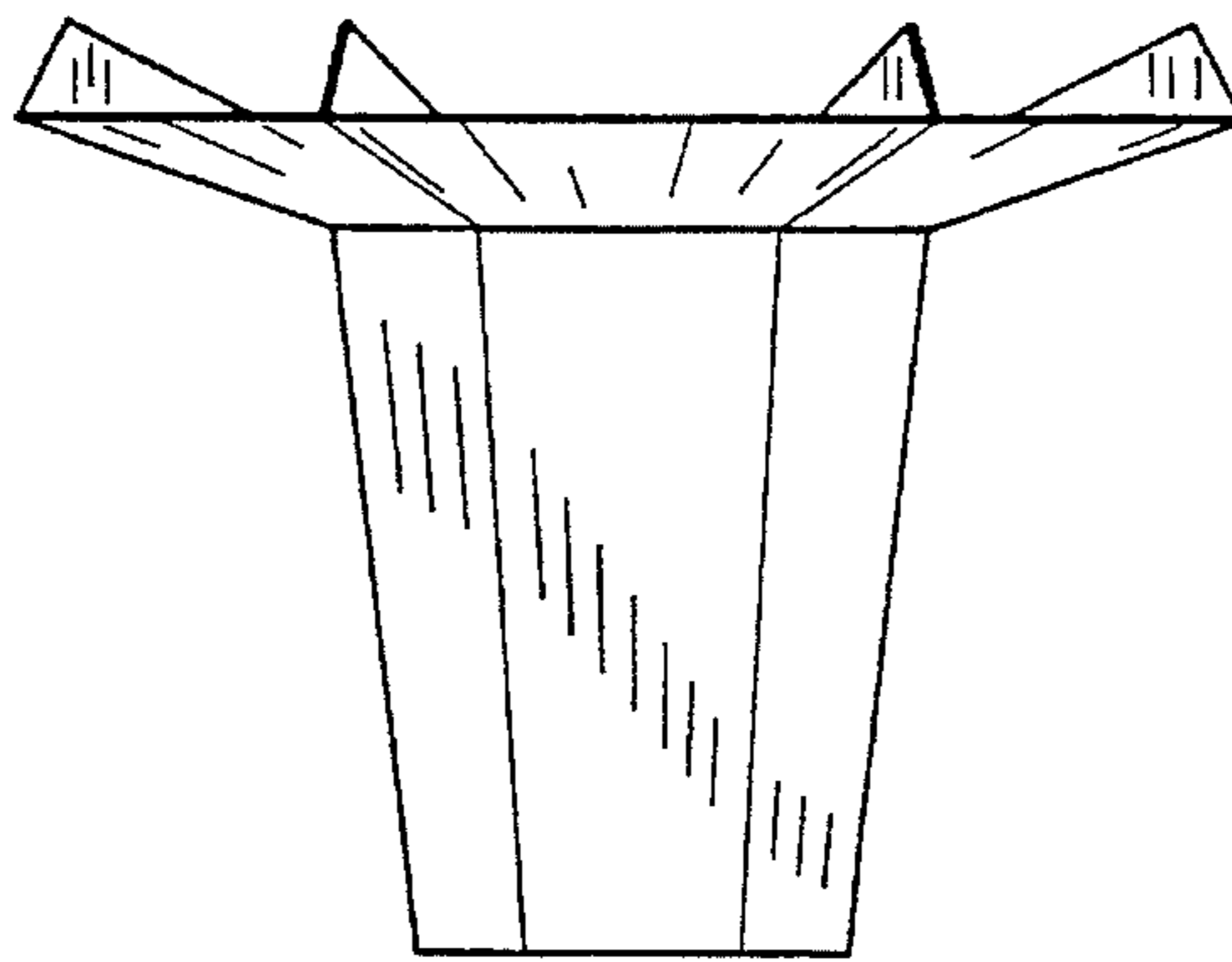

FIG. 20

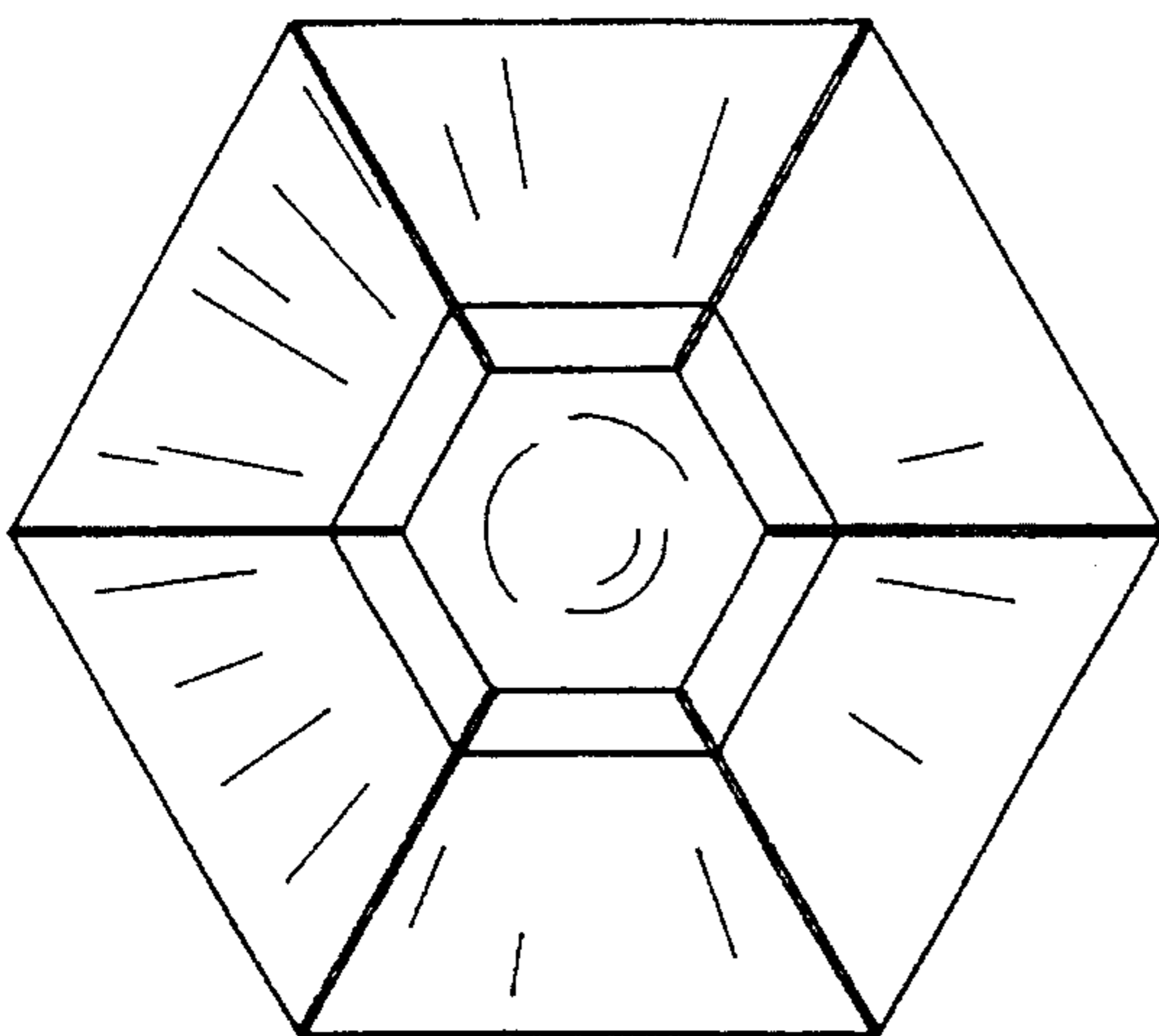

FIG. 21

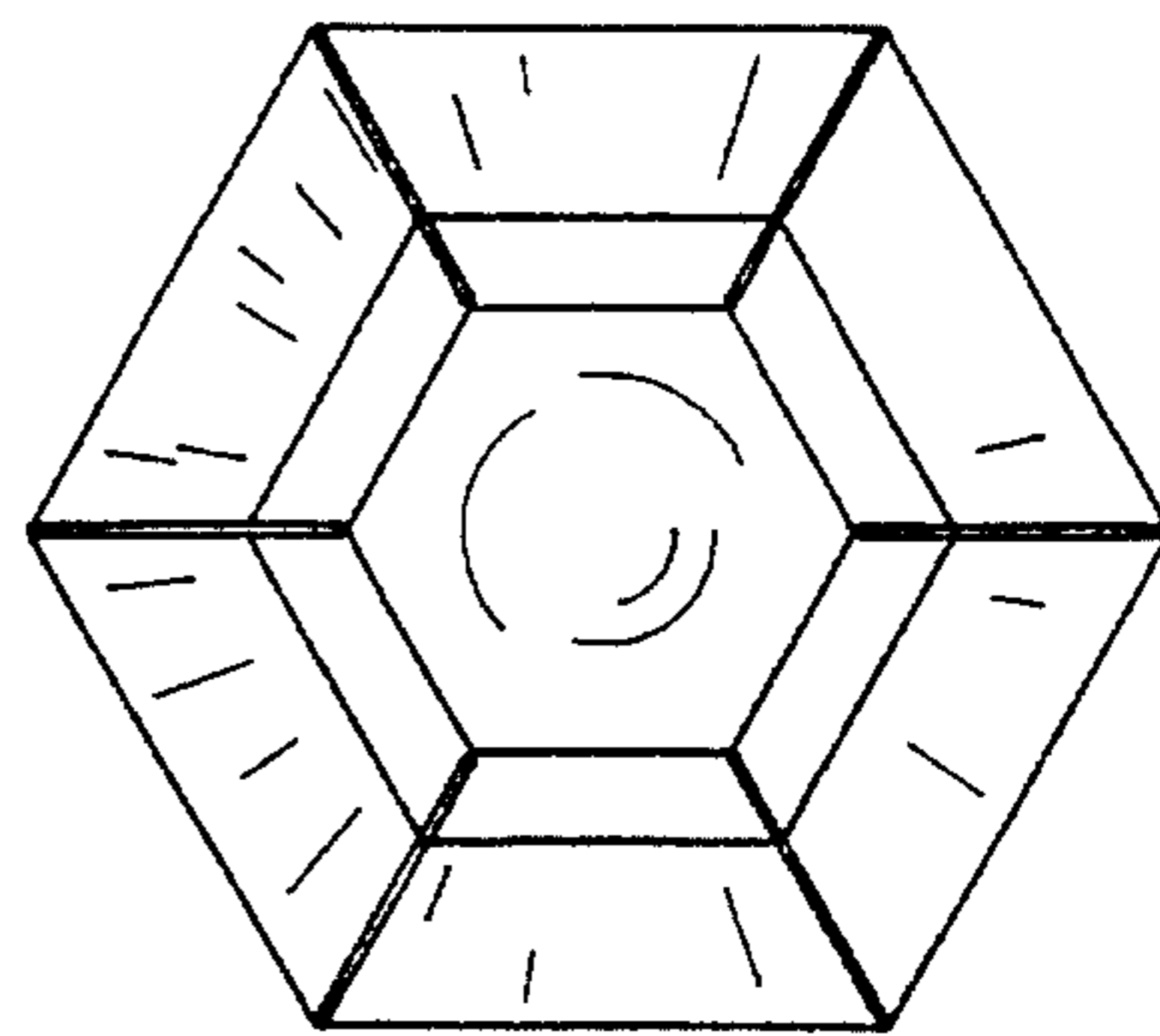

FIG. 22

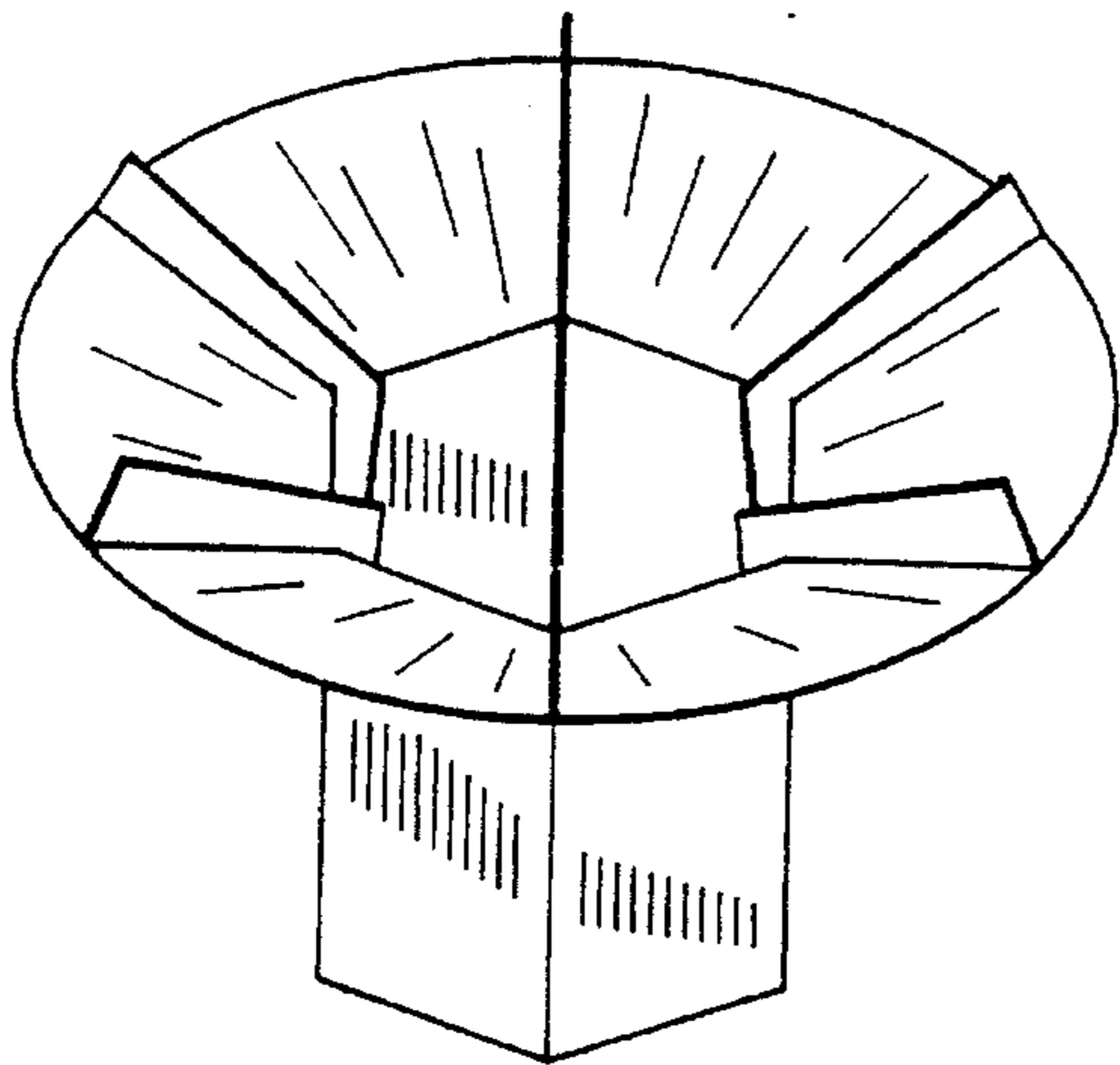

FIG. 23

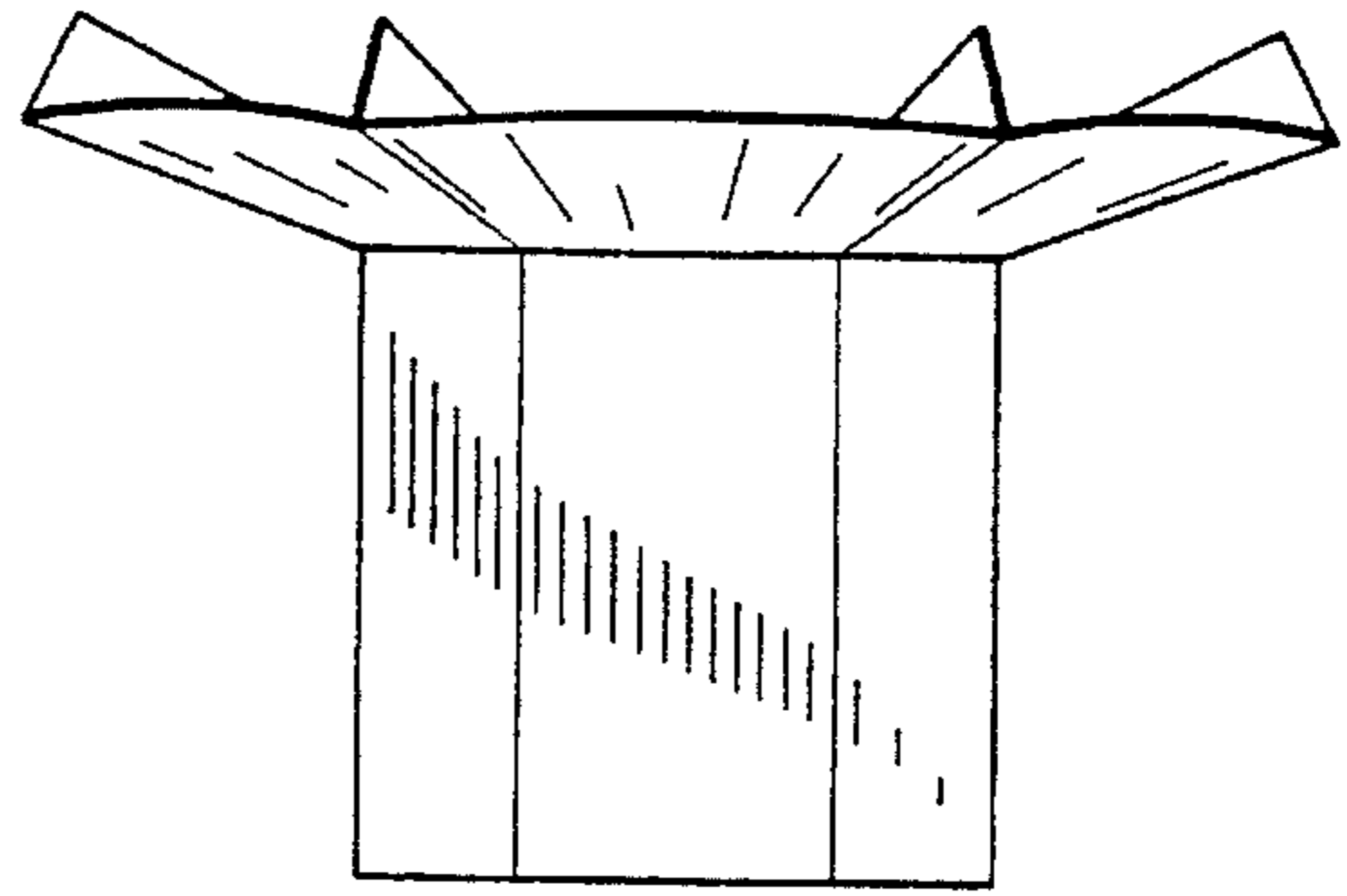

FIG. 24

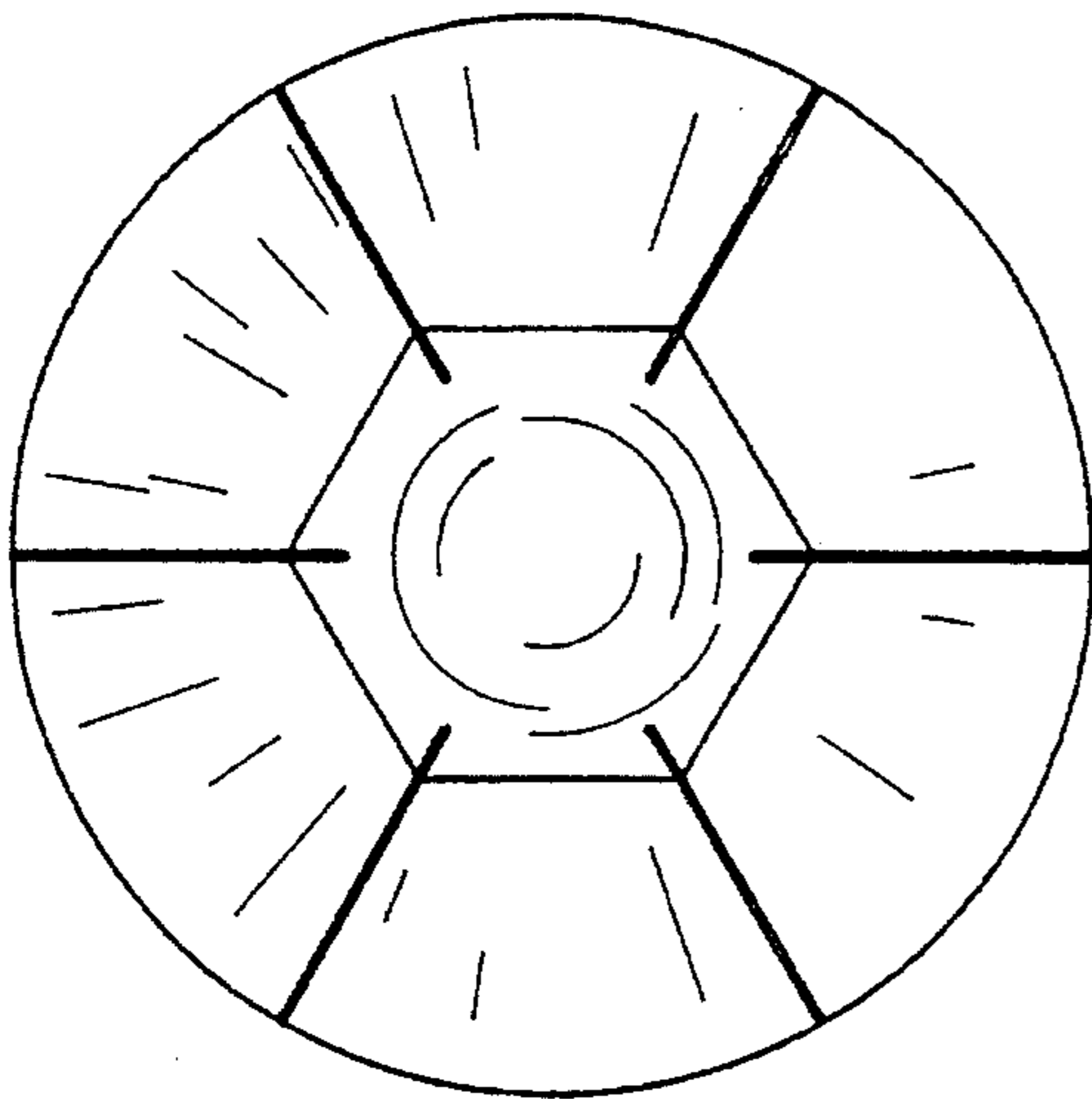

FIG. 25

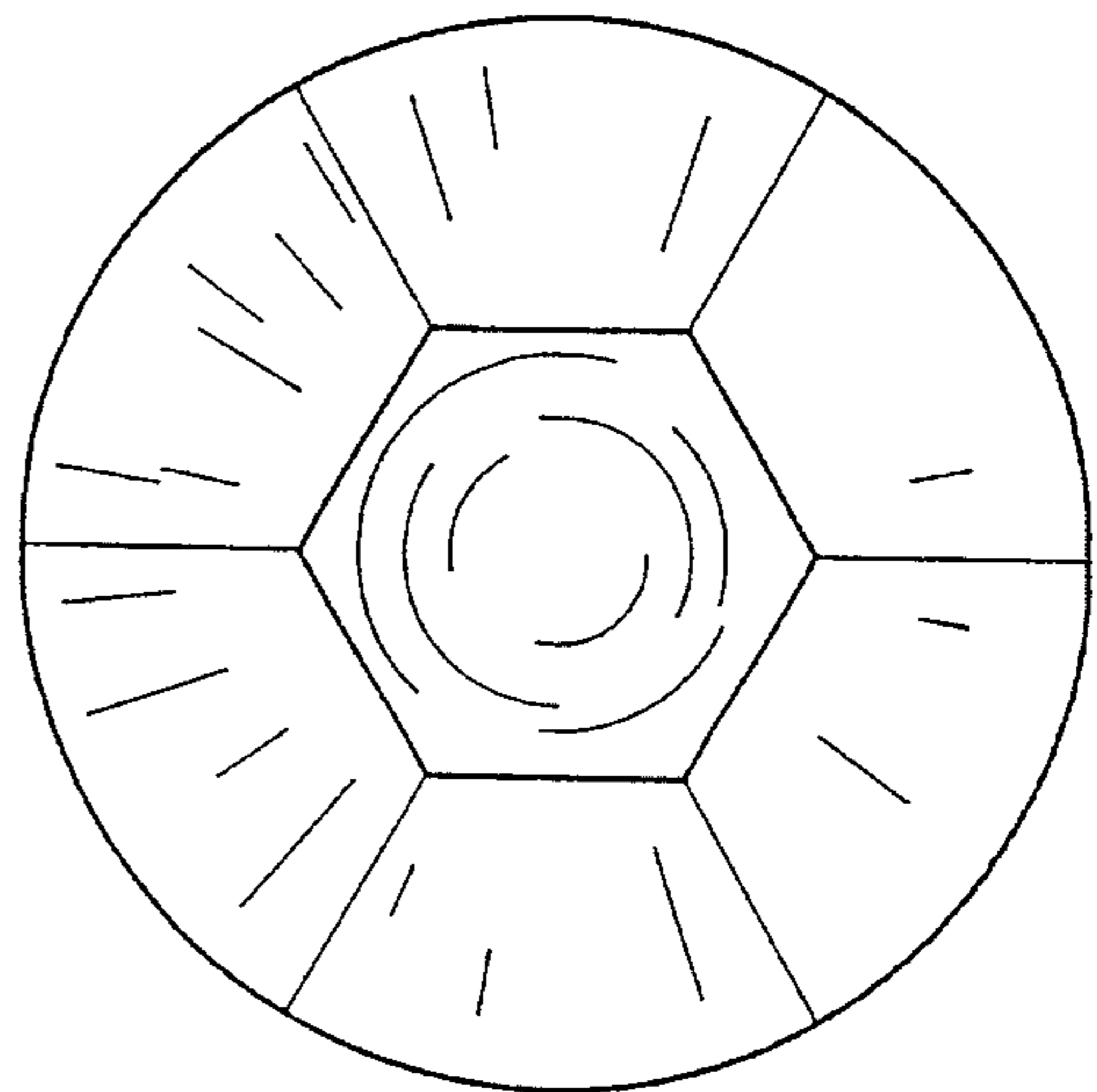

FIG. 26

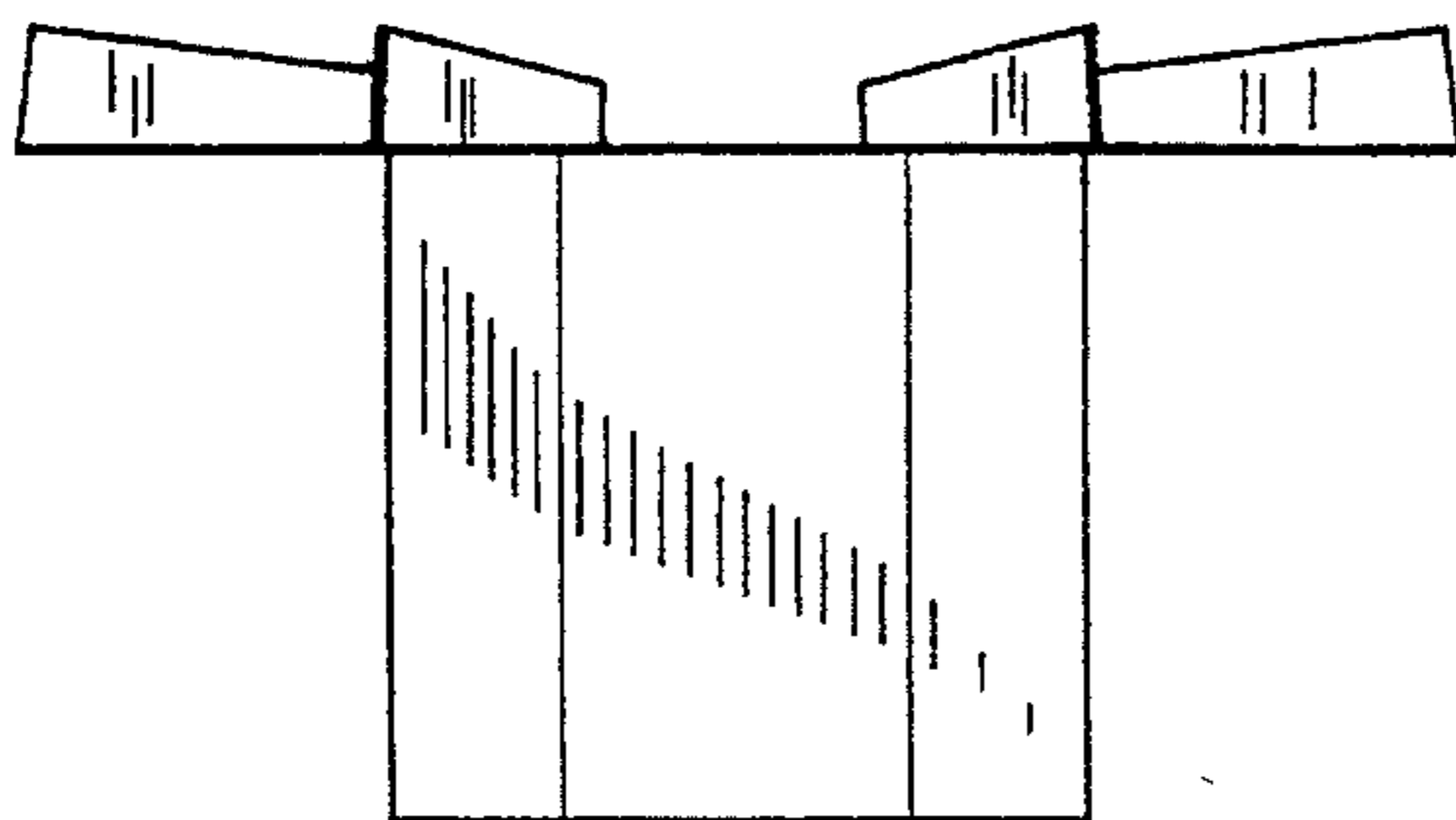

FIG. 27

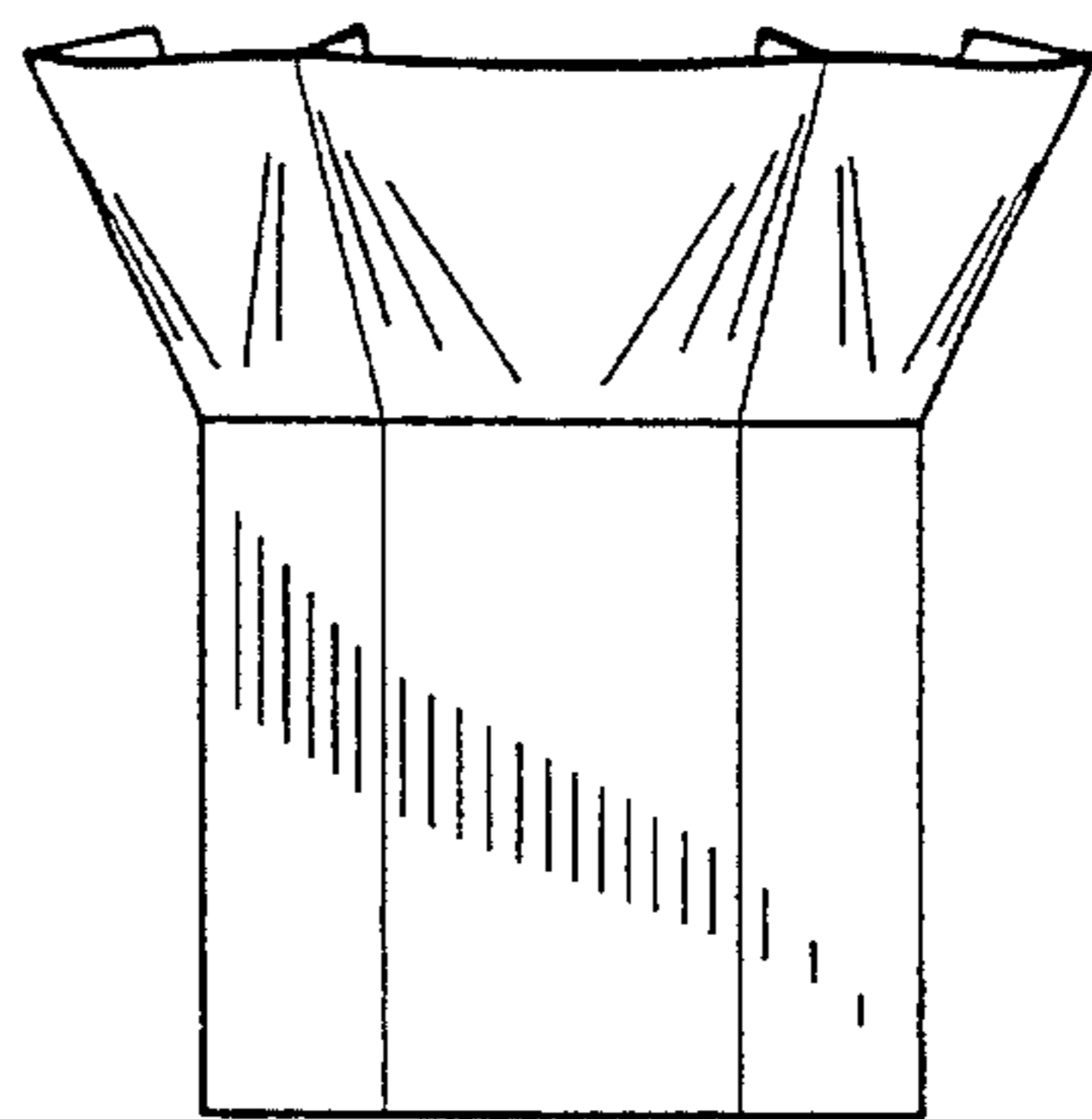

FIG. 28

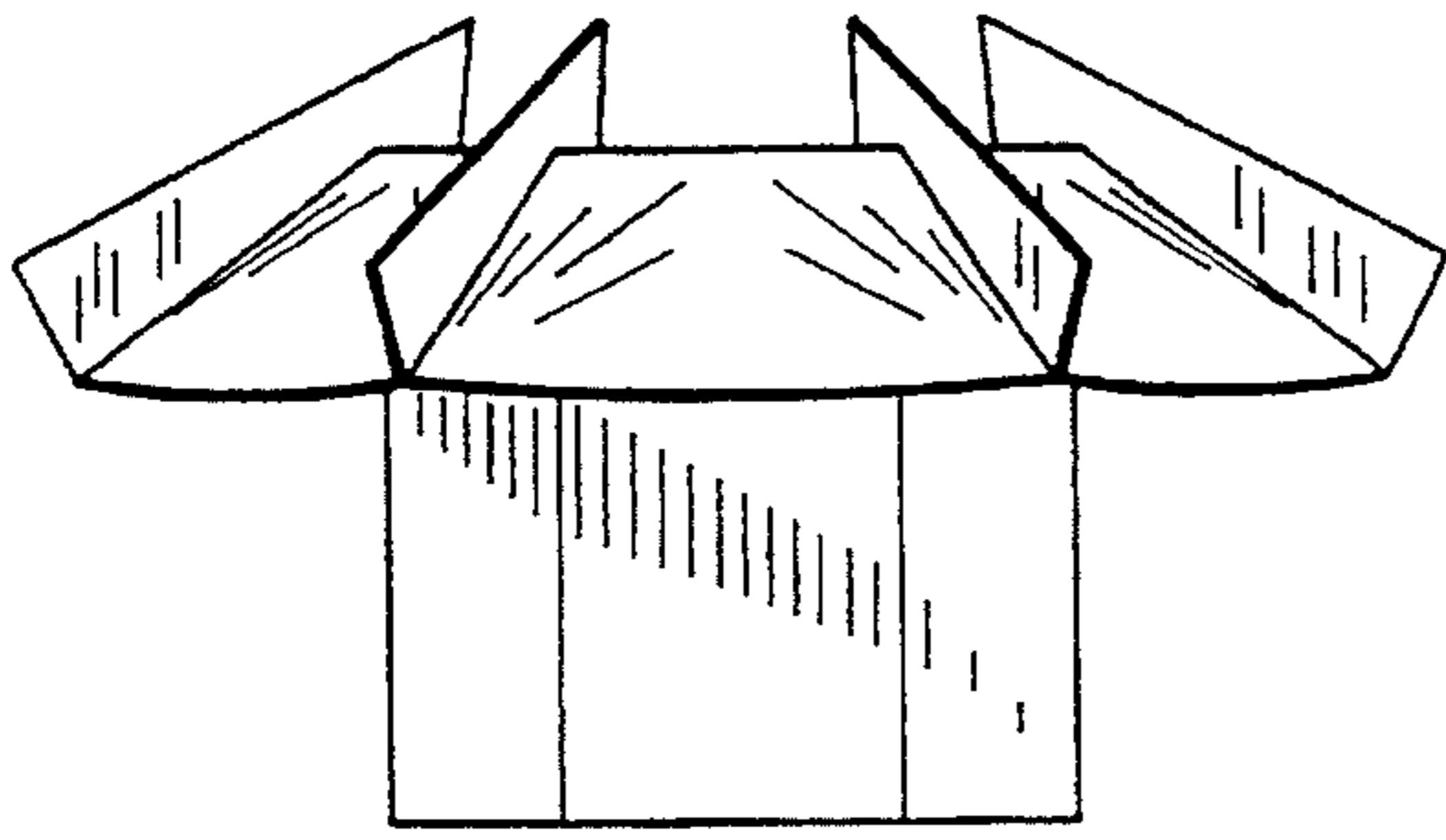

FIG. 29

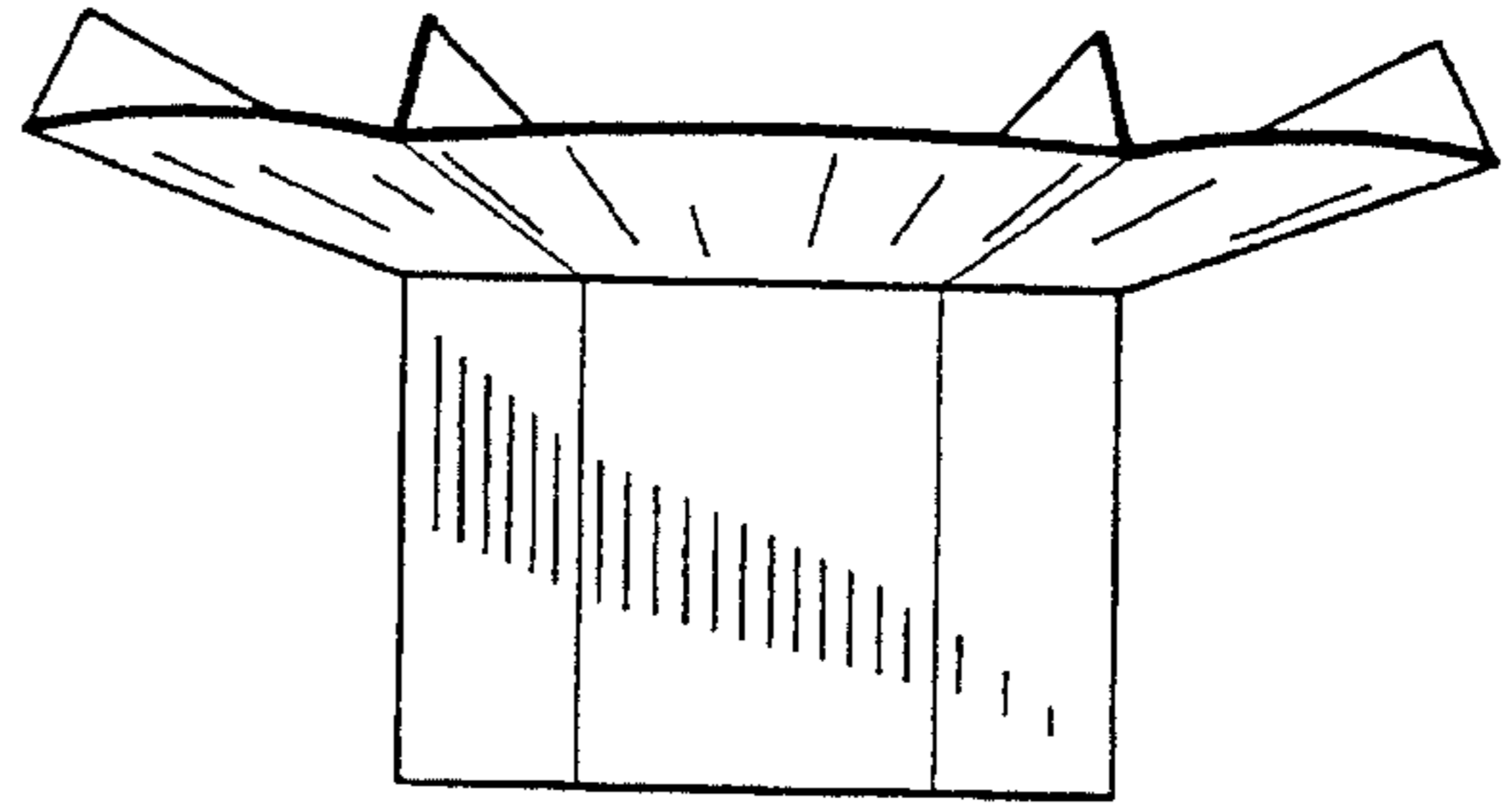

FIG. 30

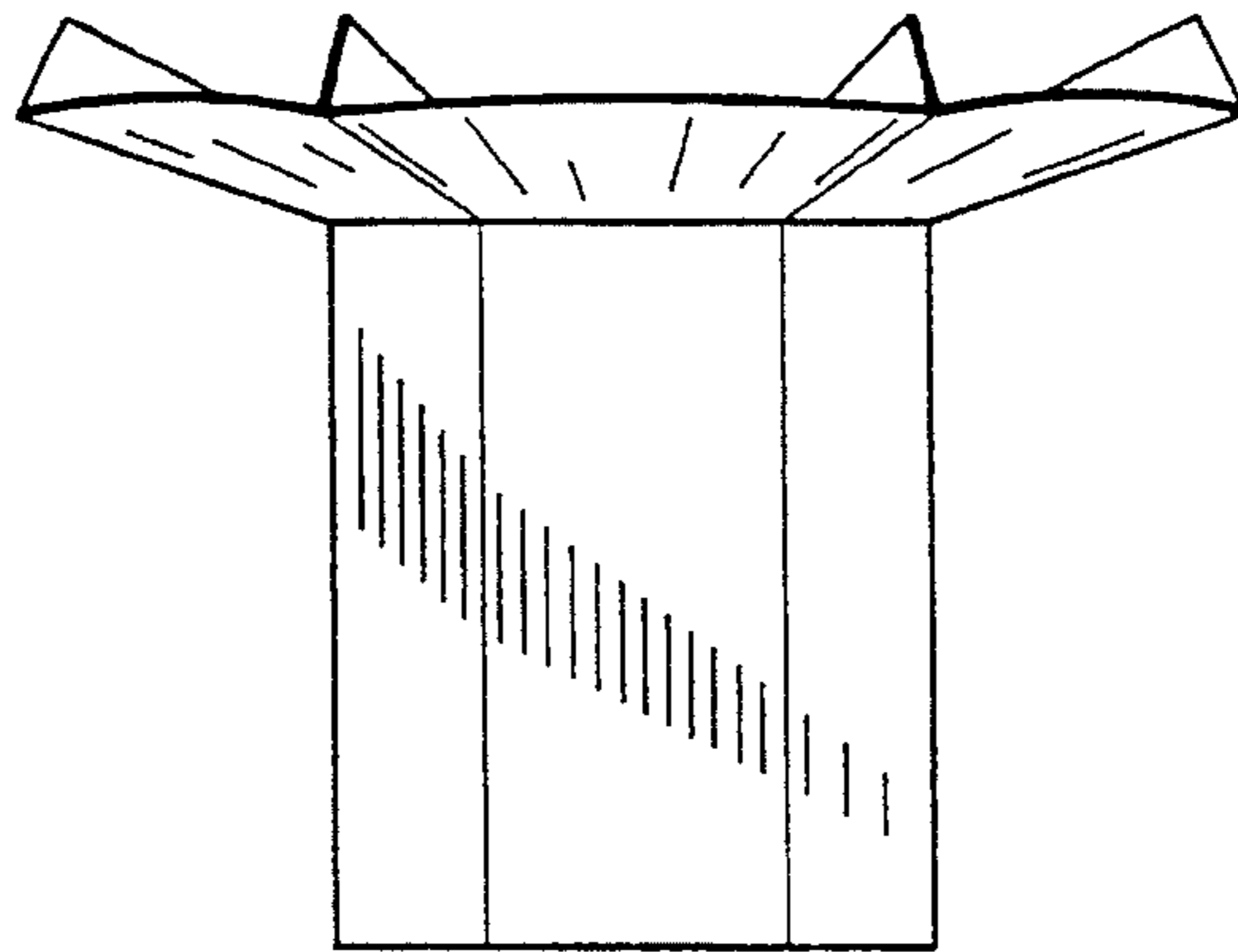

FIG. 31

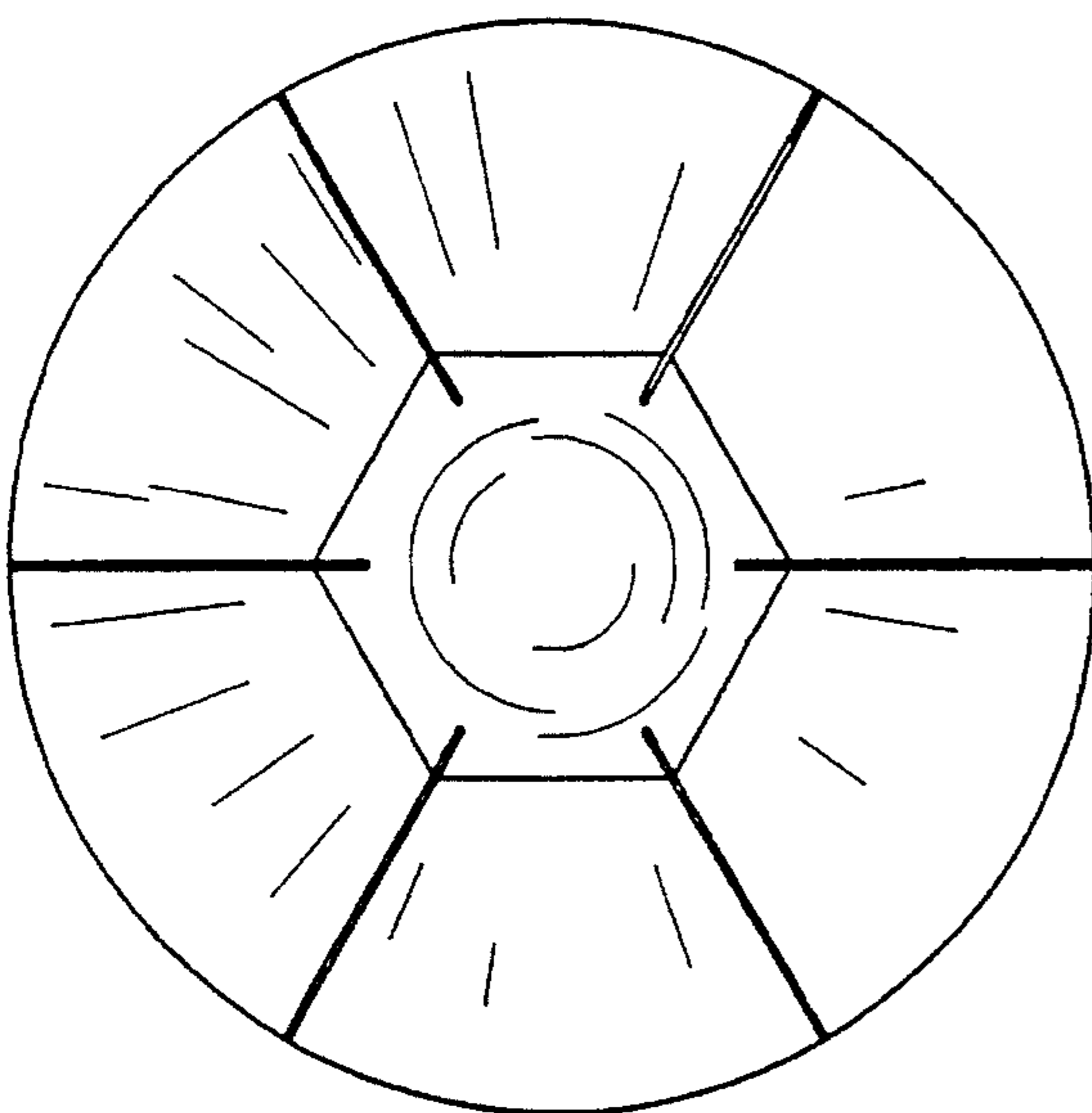

FIG. 32

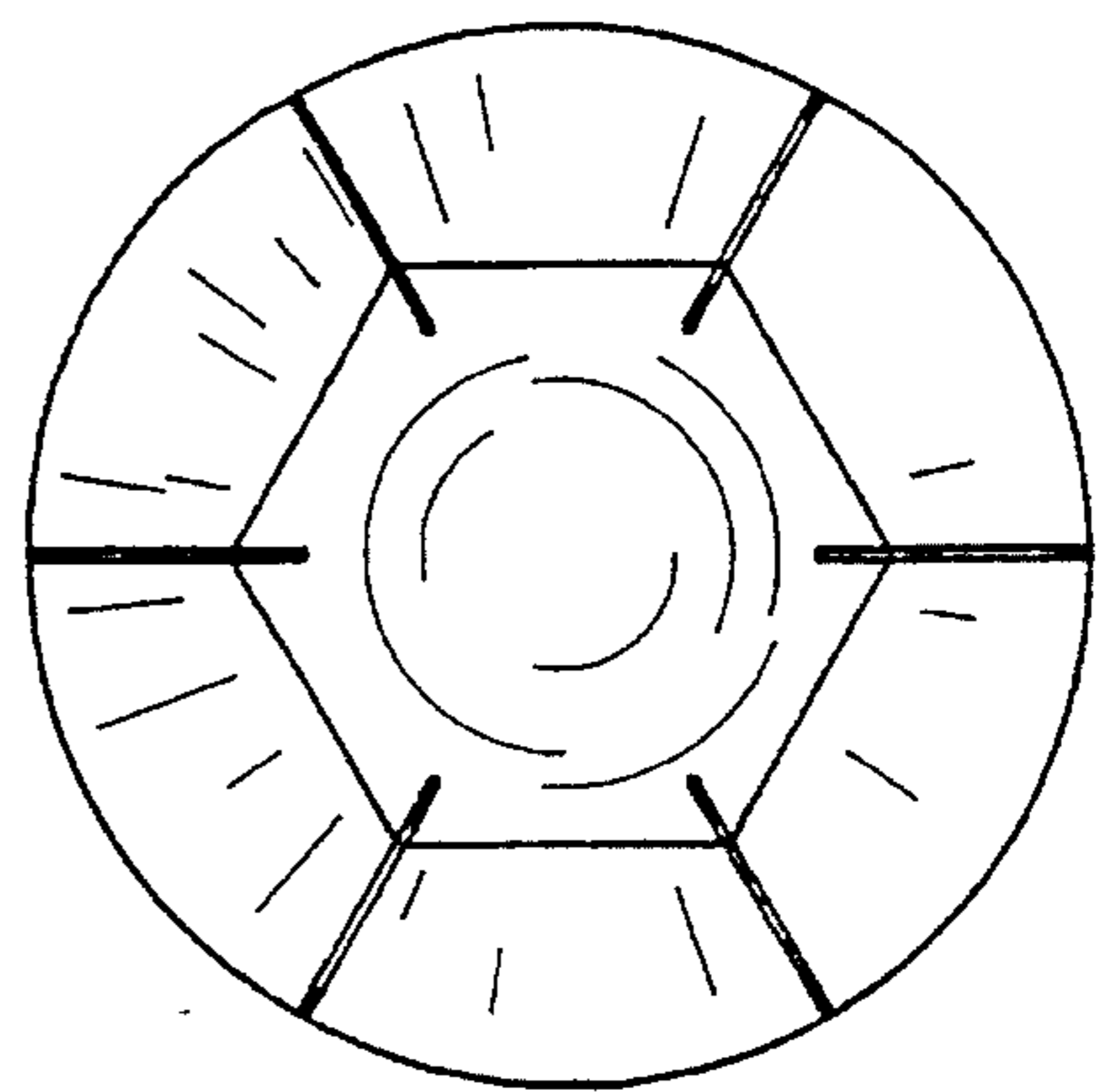

FIG. 33



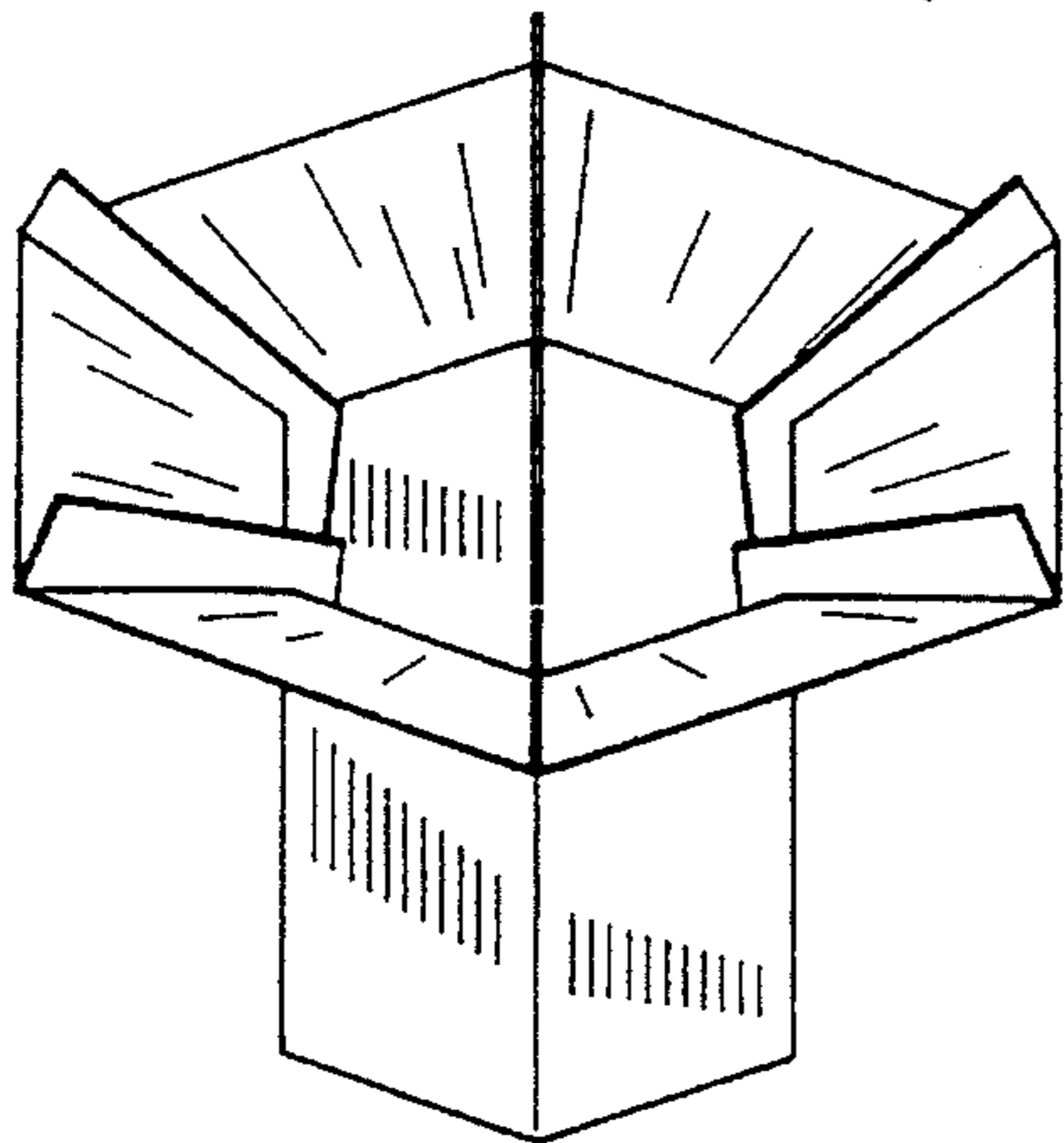

FIG. 34

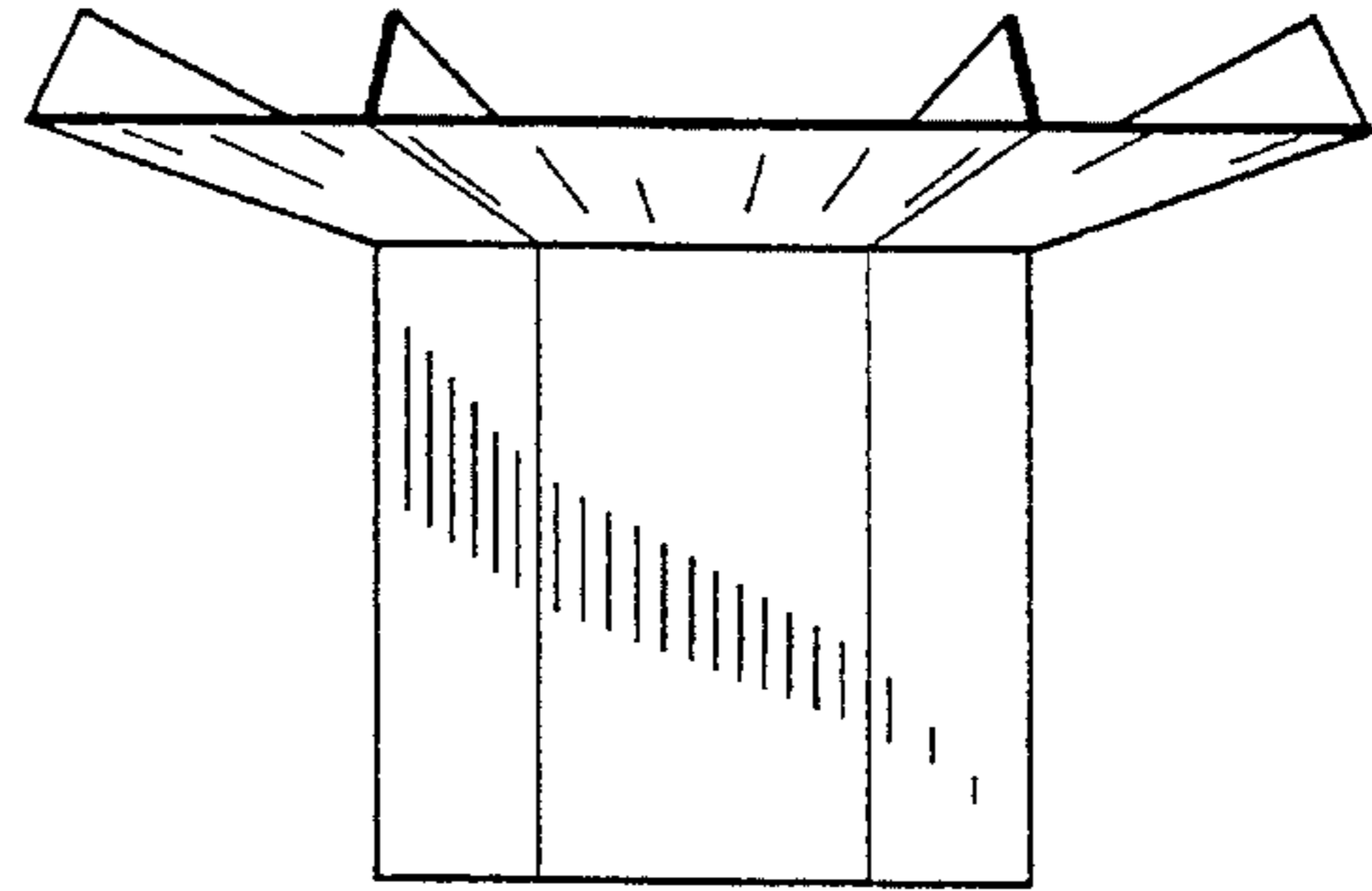

FIG. 35

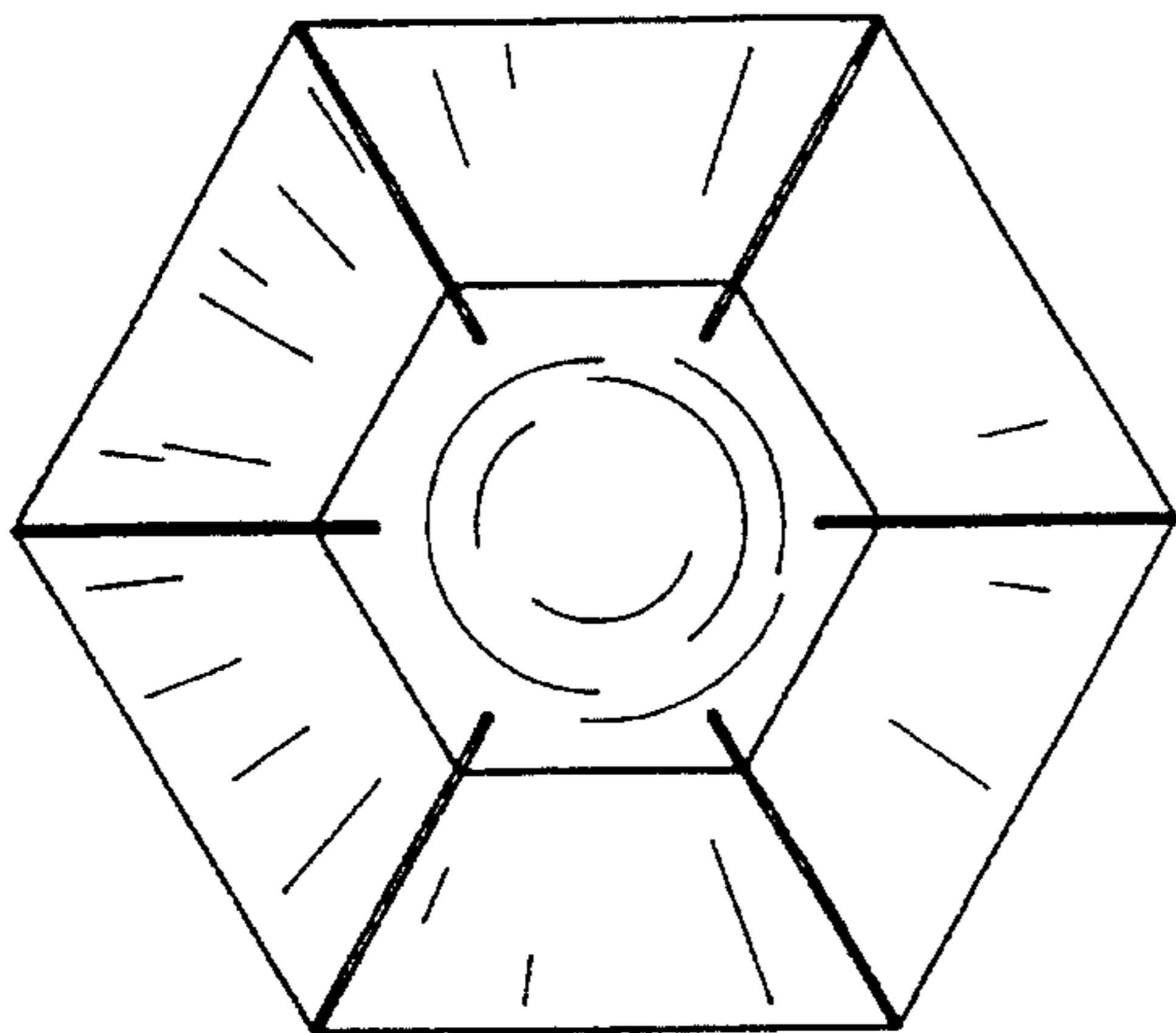

FIG. 36

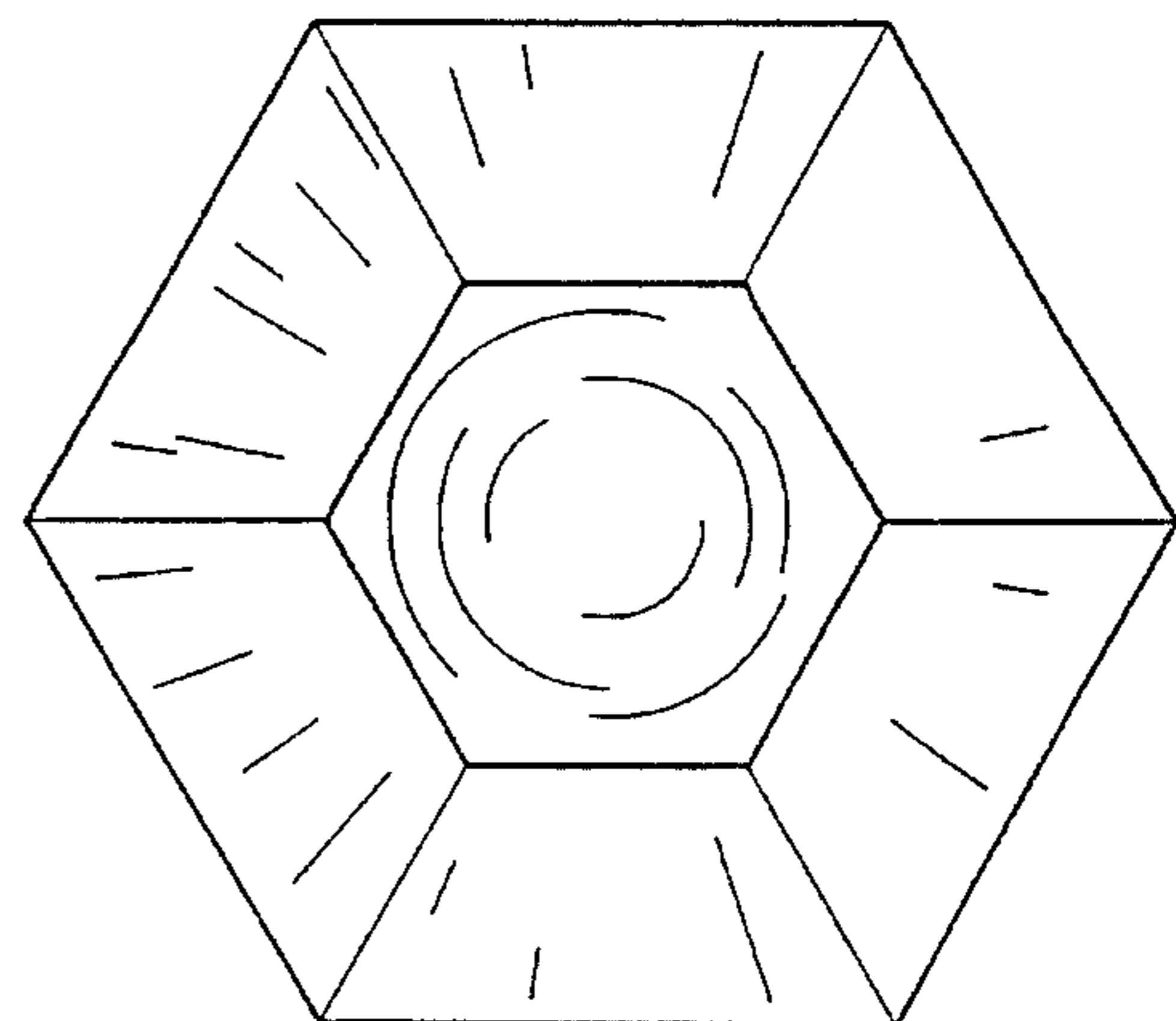

FIG. 37

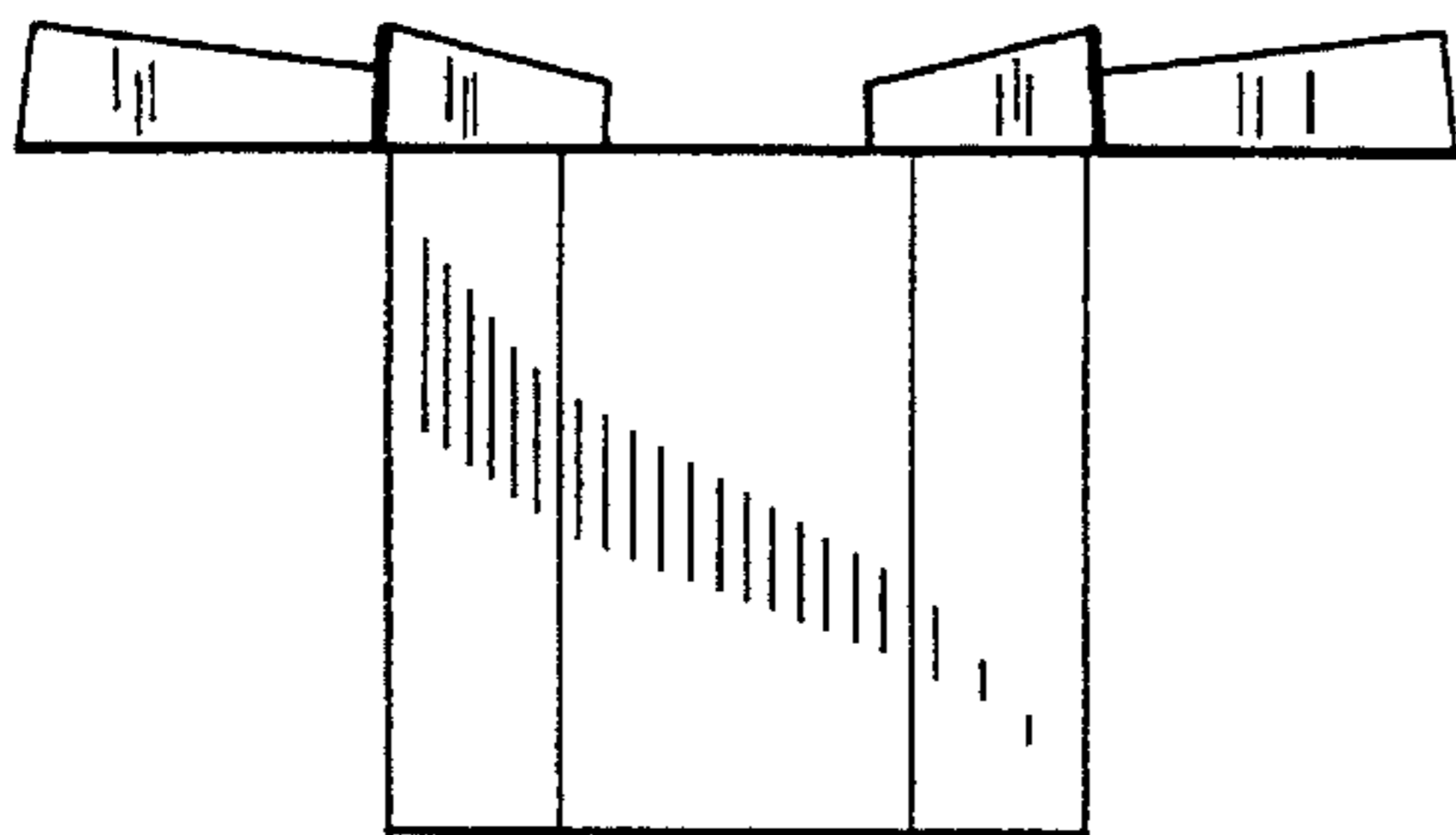

FIG. 38

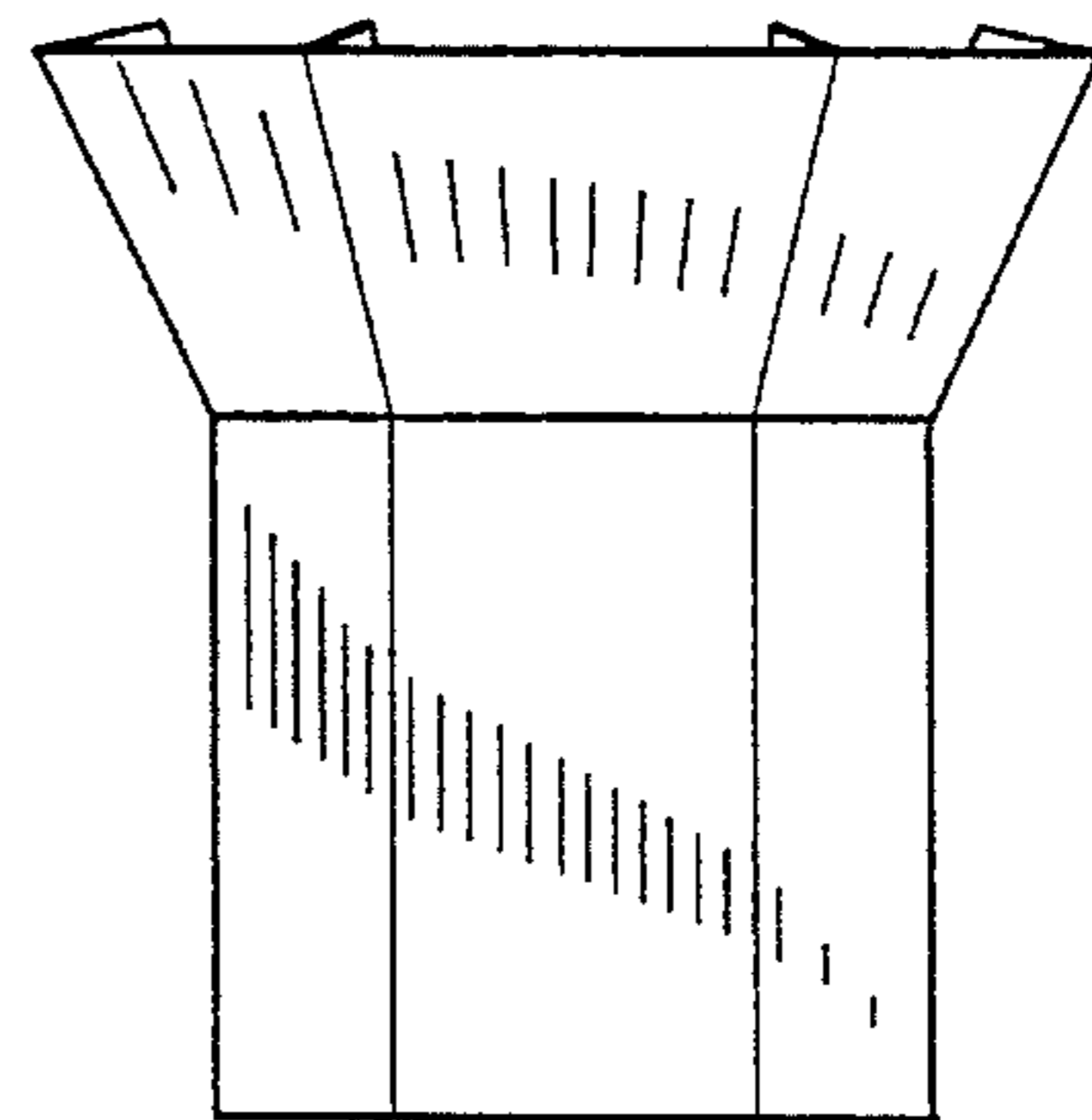

FIG. 39

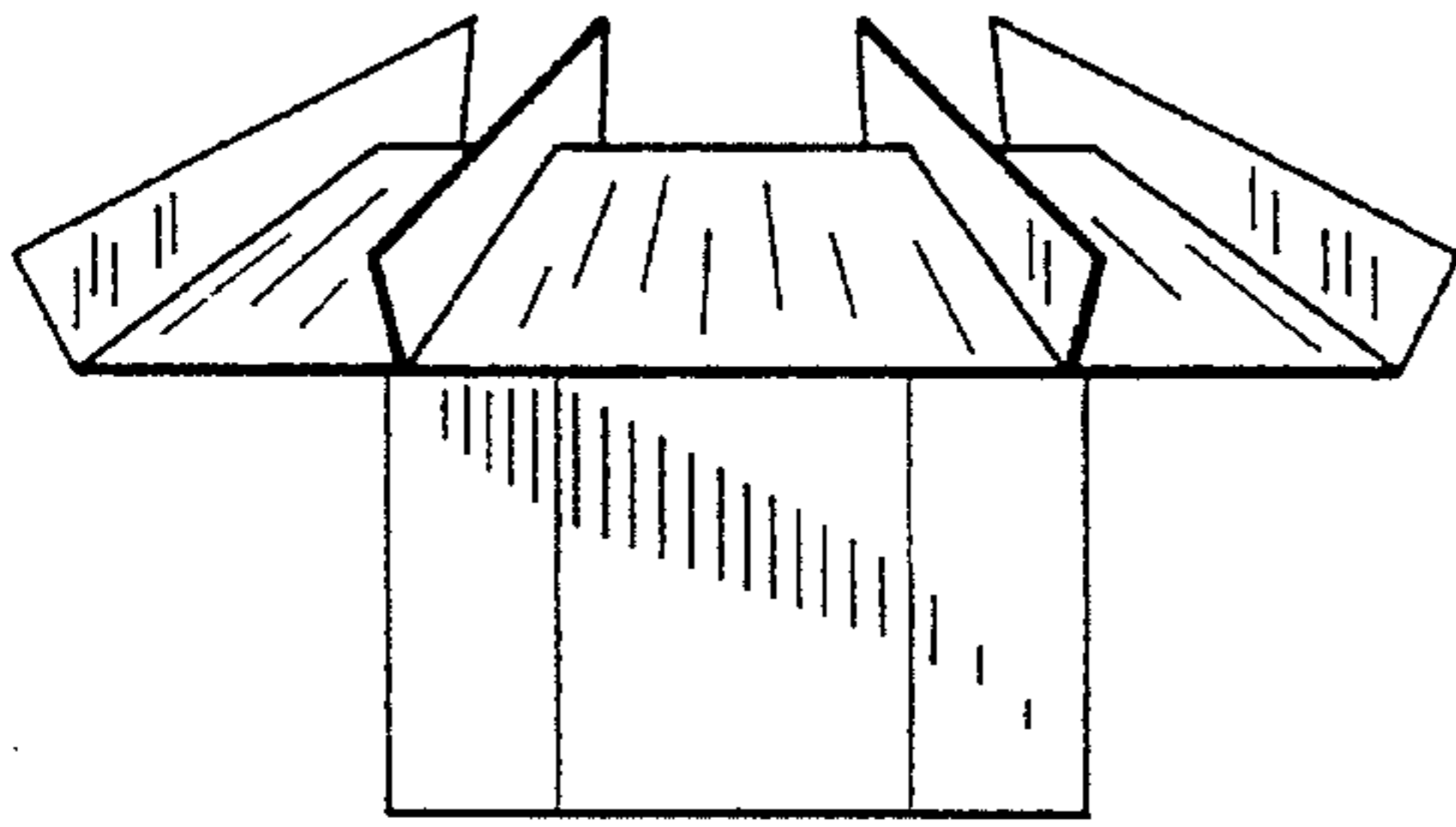

FIG. 40

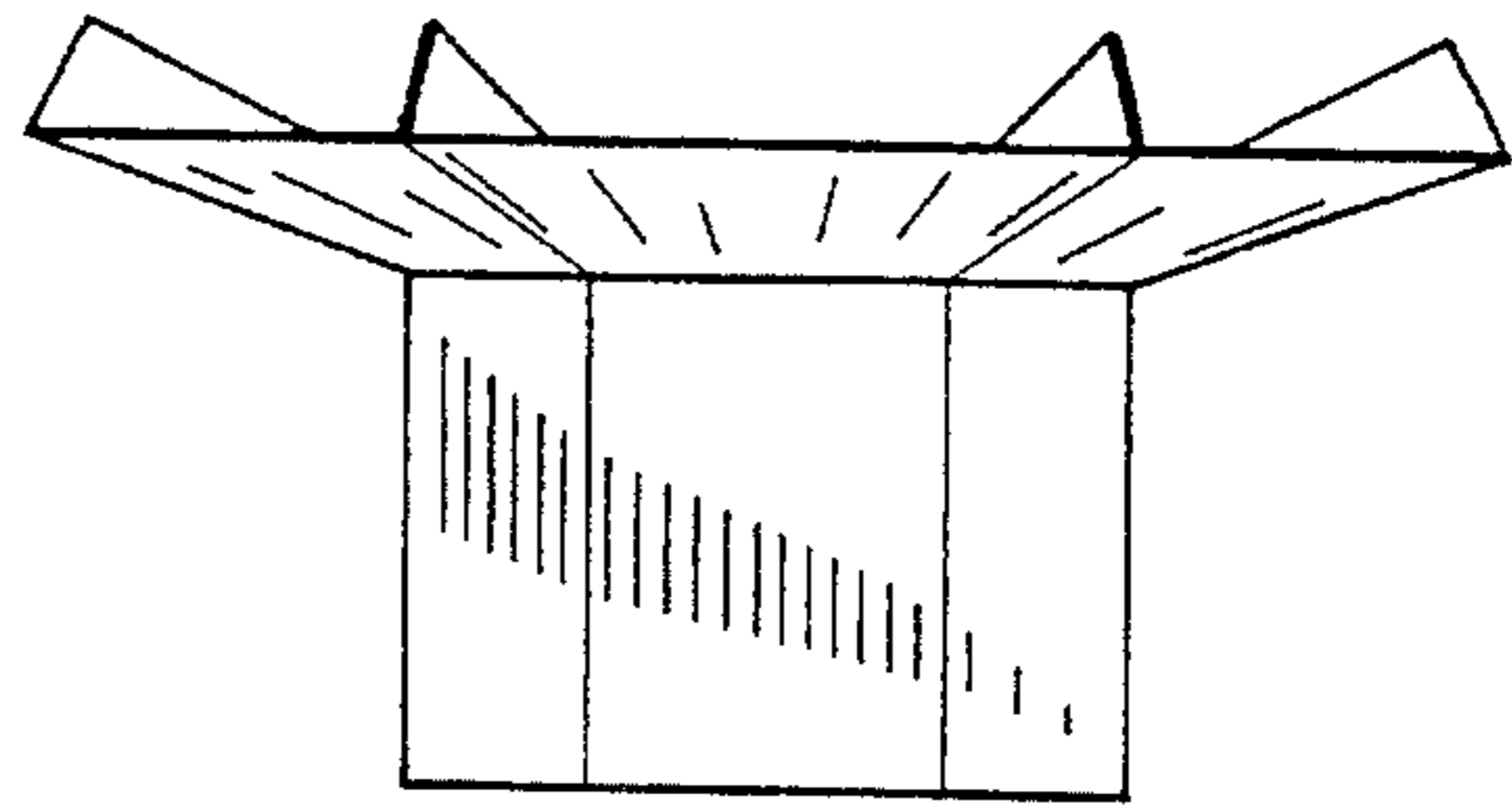

FIG. 41

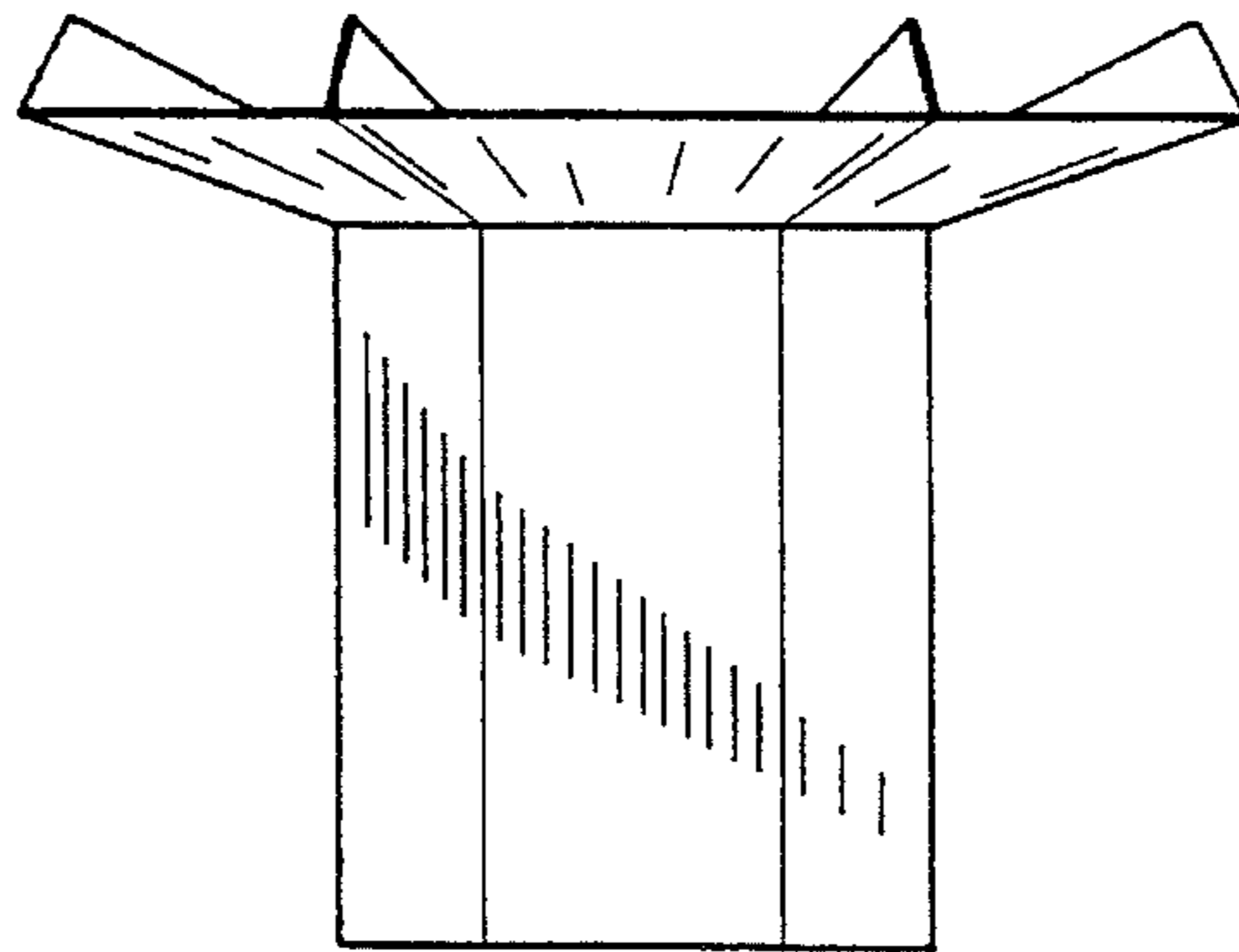

FIG. 42

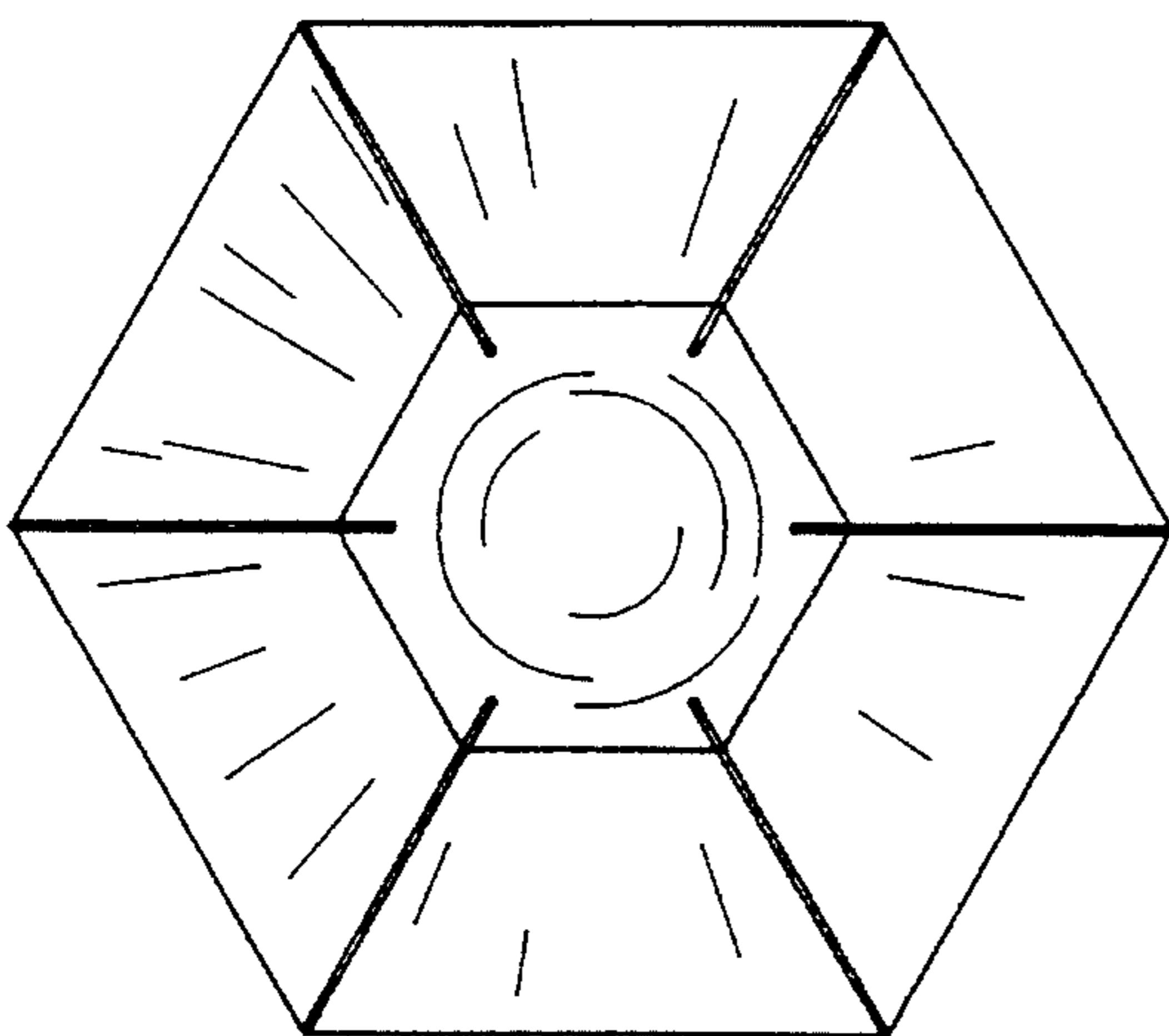

FIG. 43

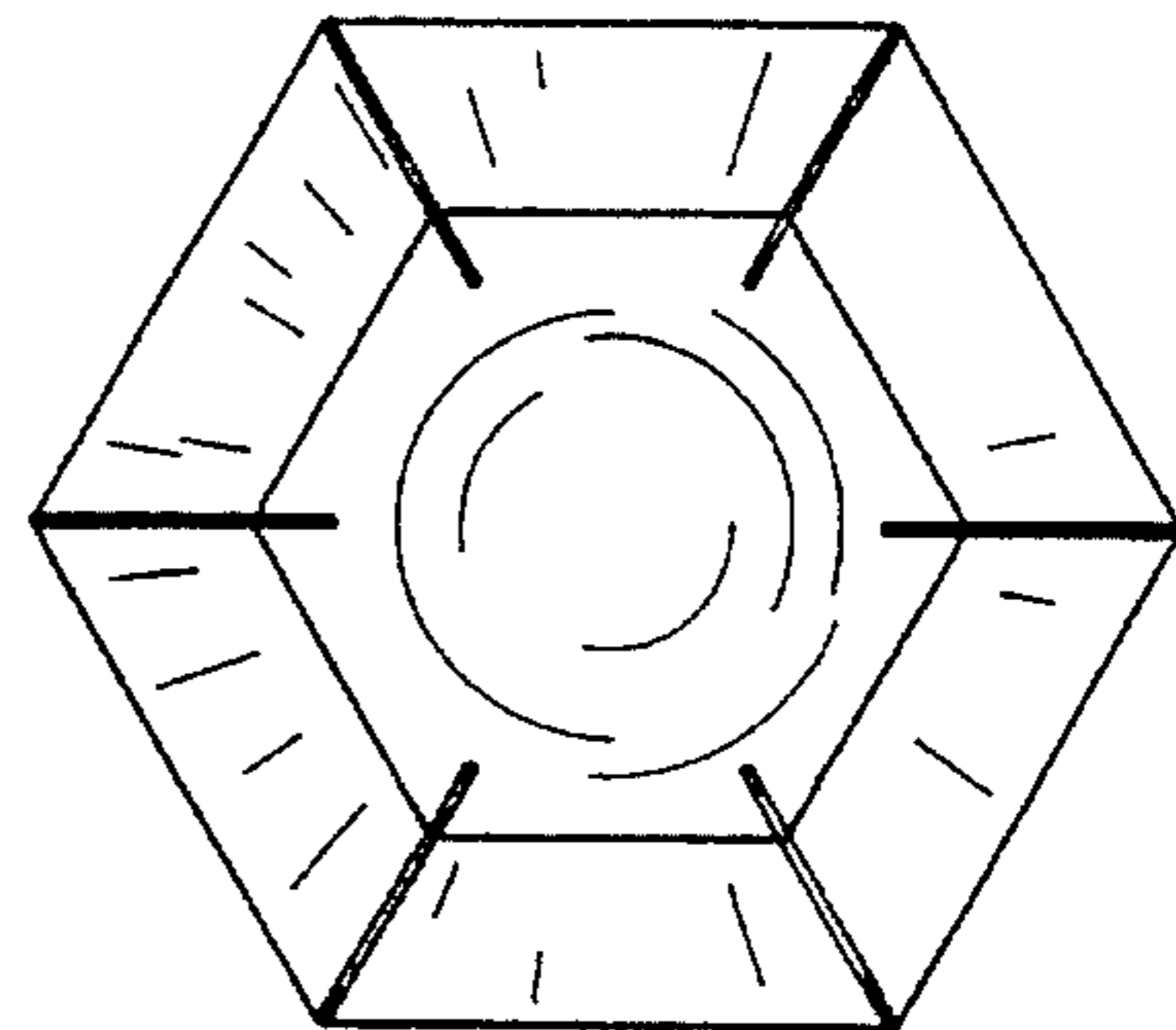

FIG. 44

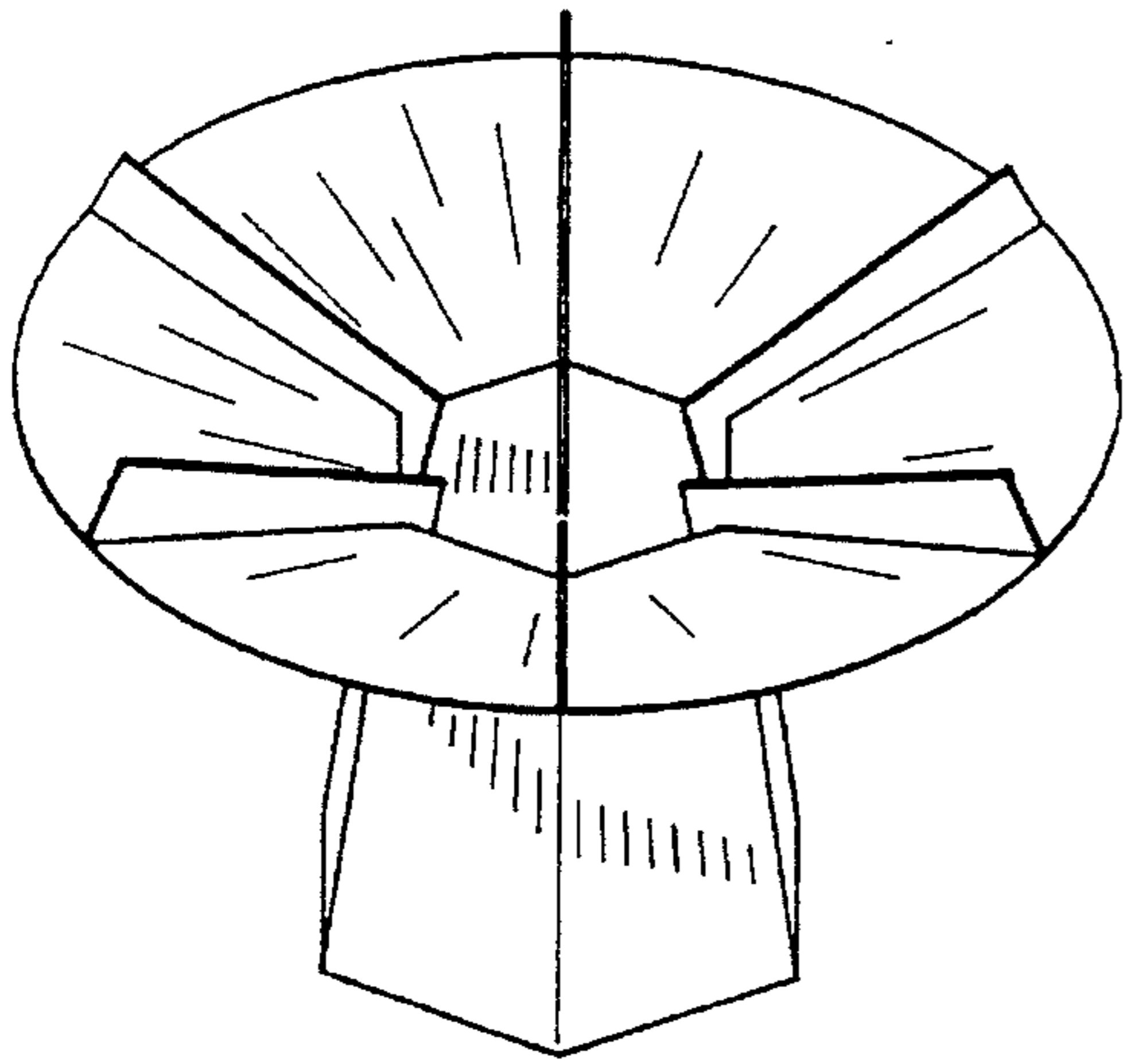

FIG. 45

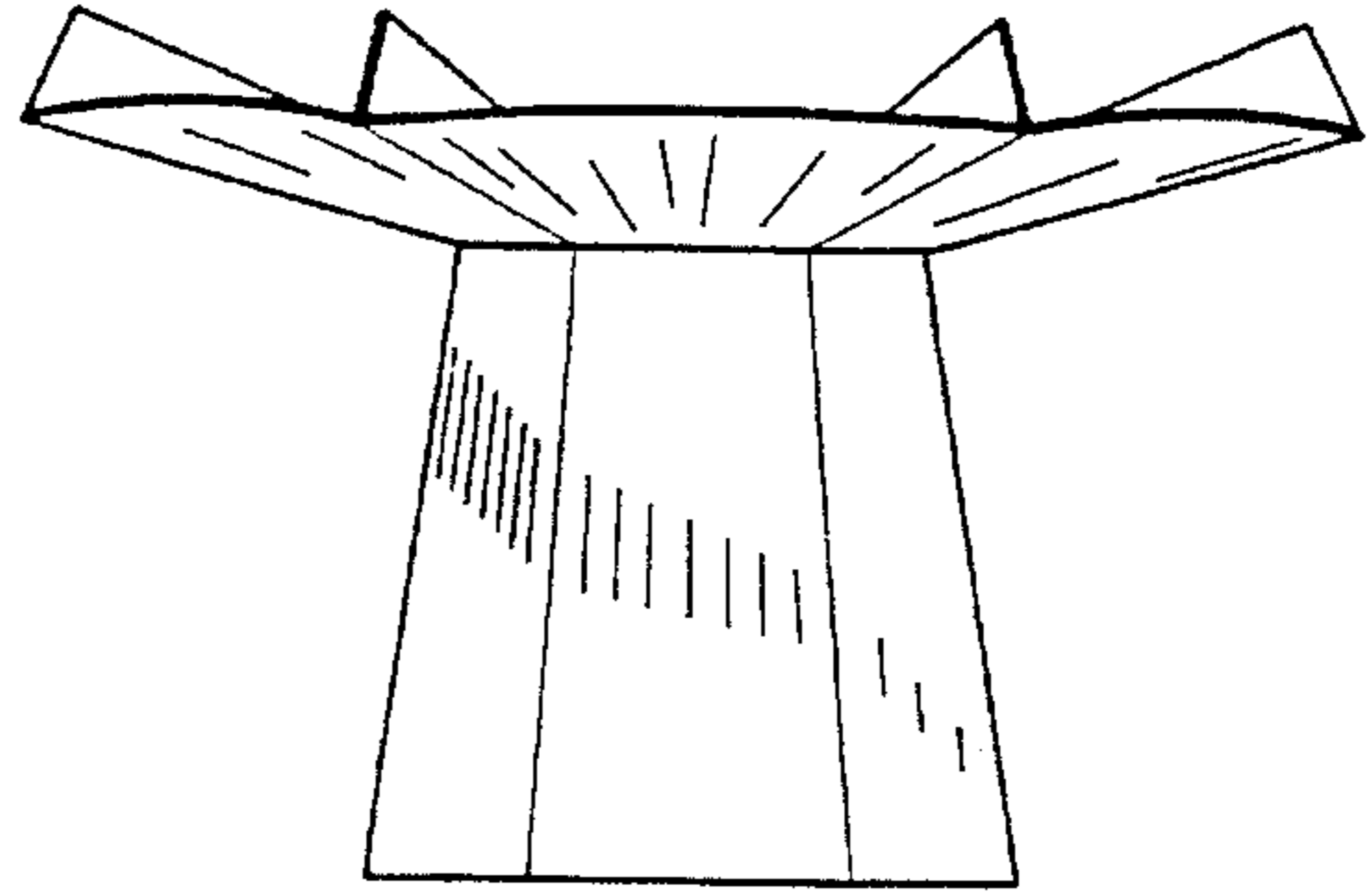

FIG. 46

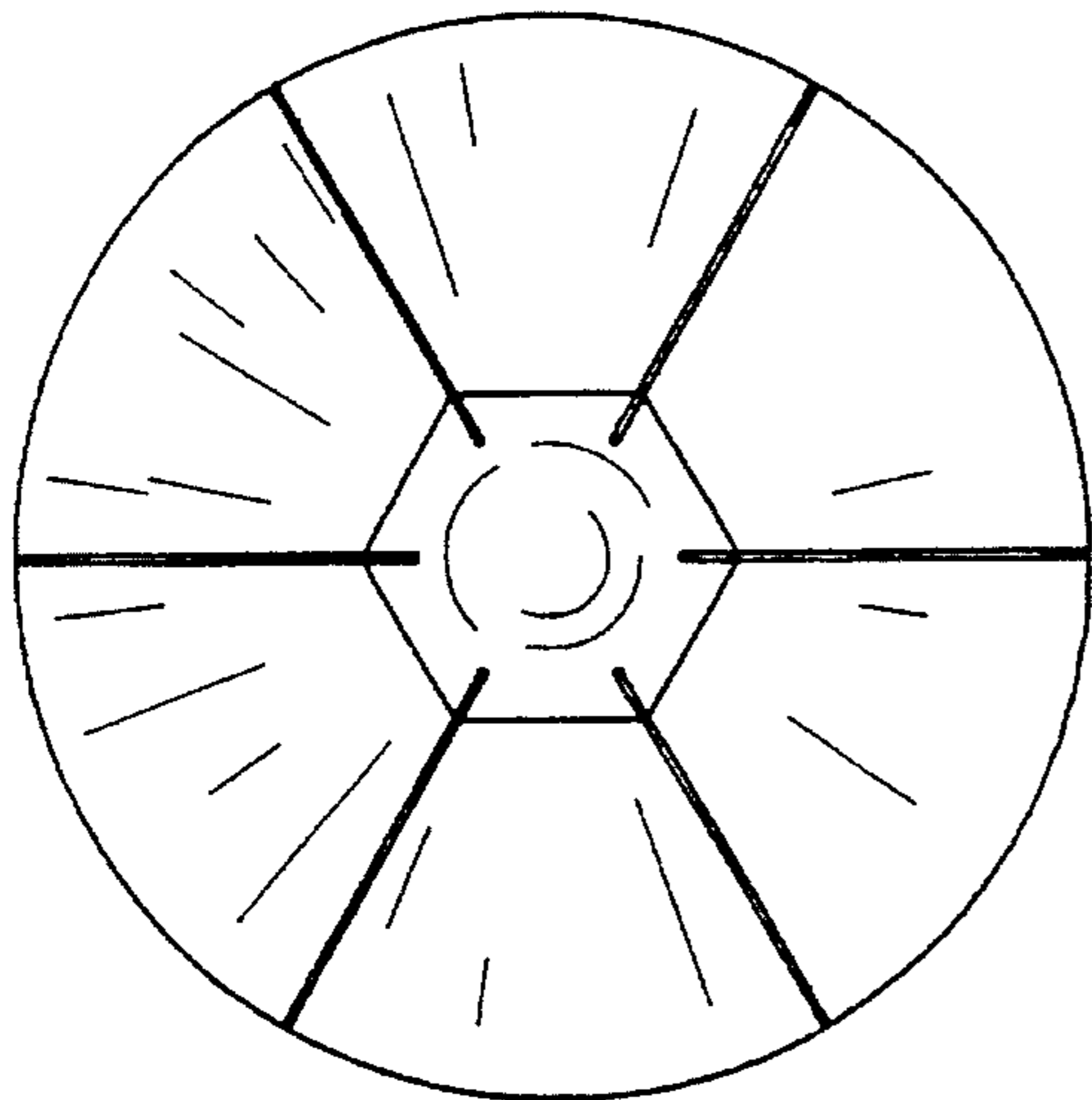

FIG. 47

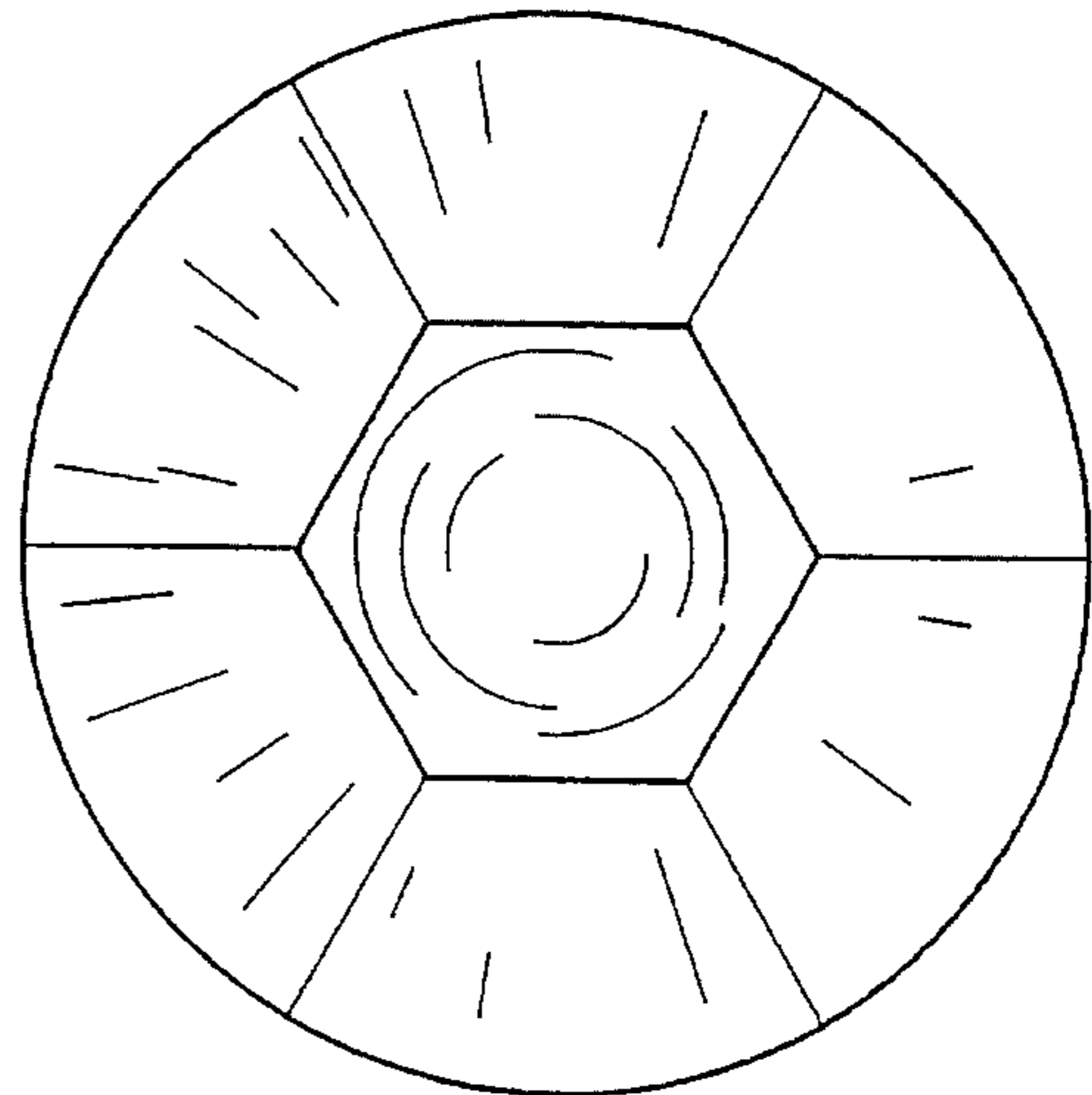

FIG. 48

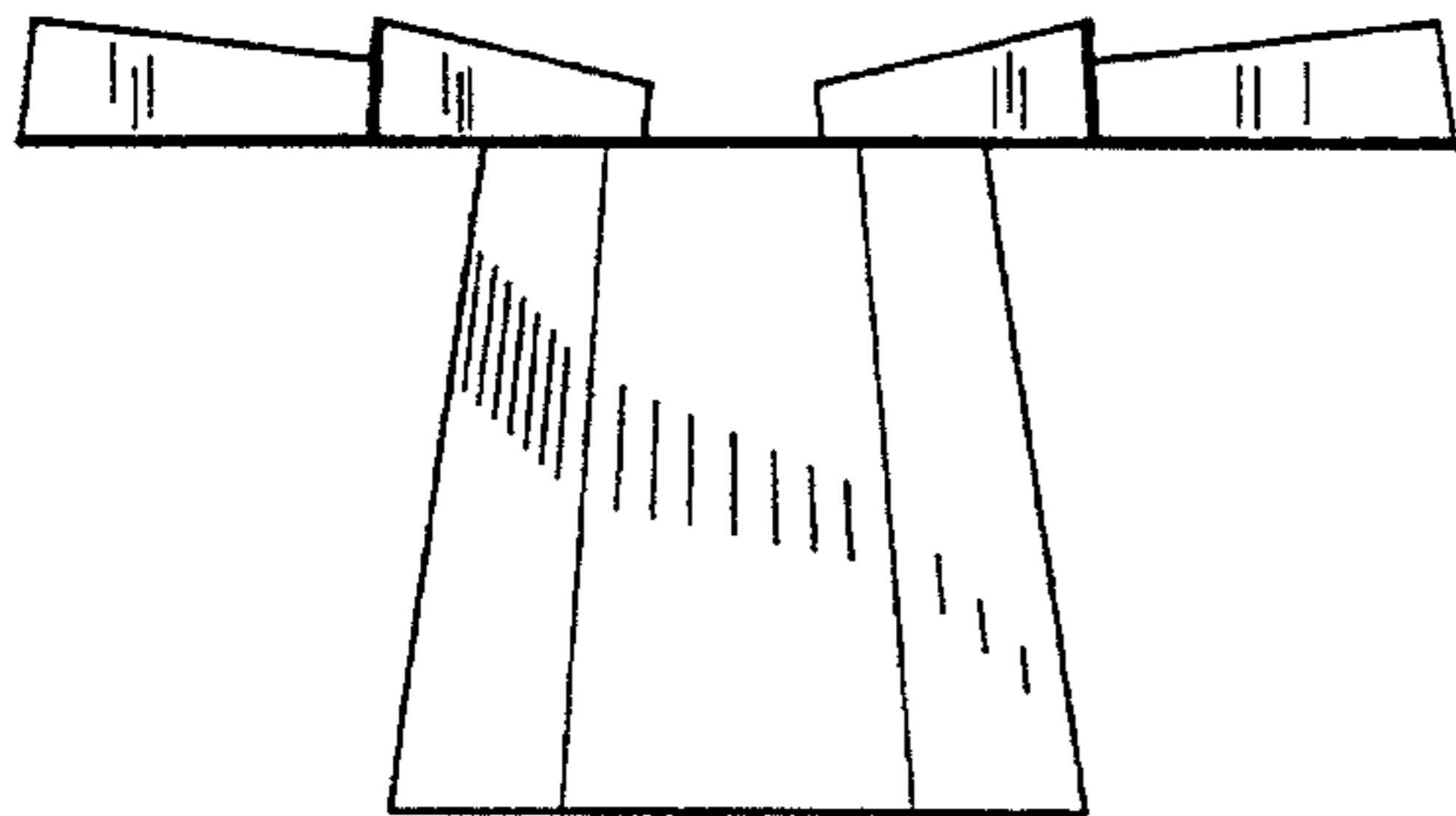

FIG. 49

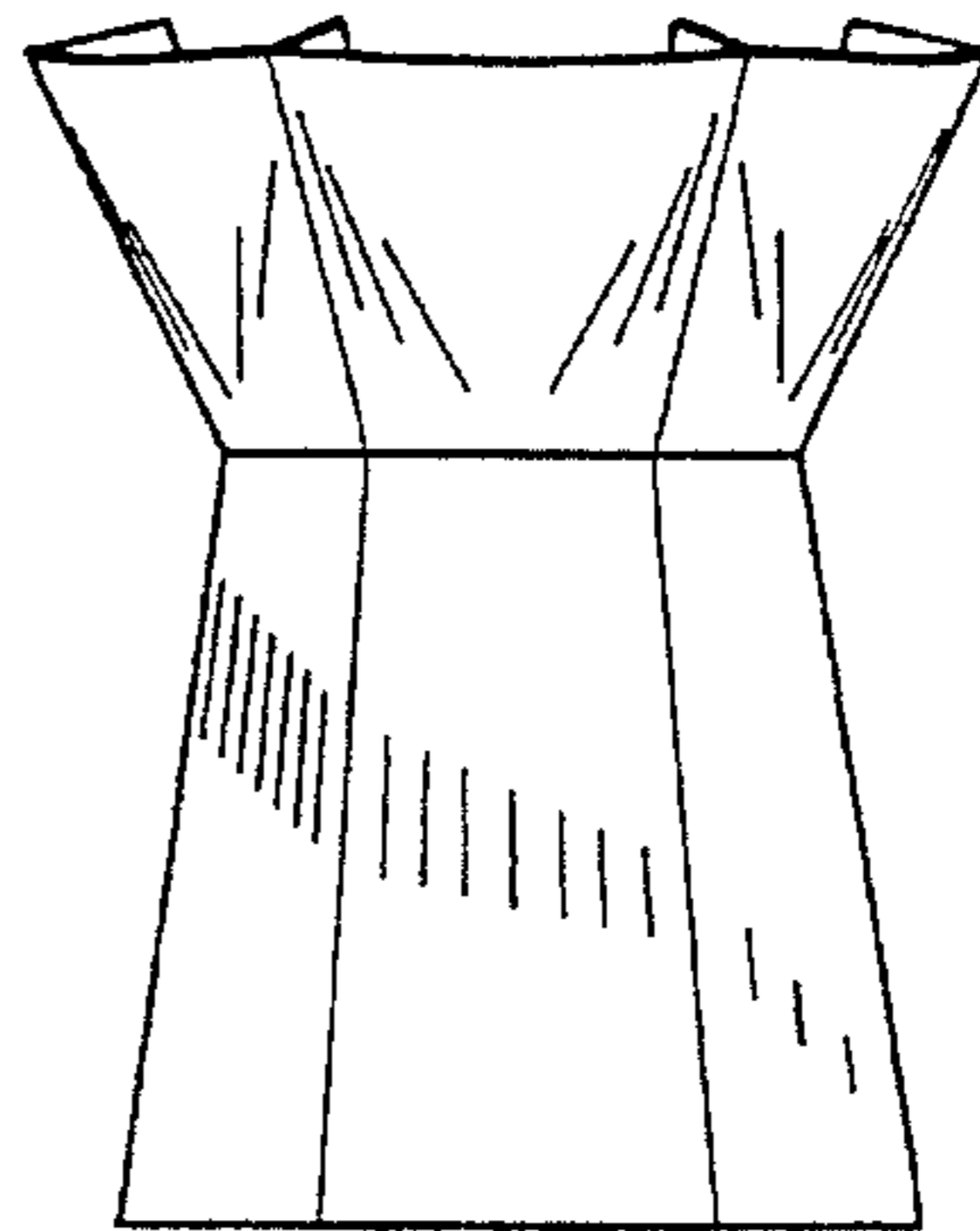

FIG. 50

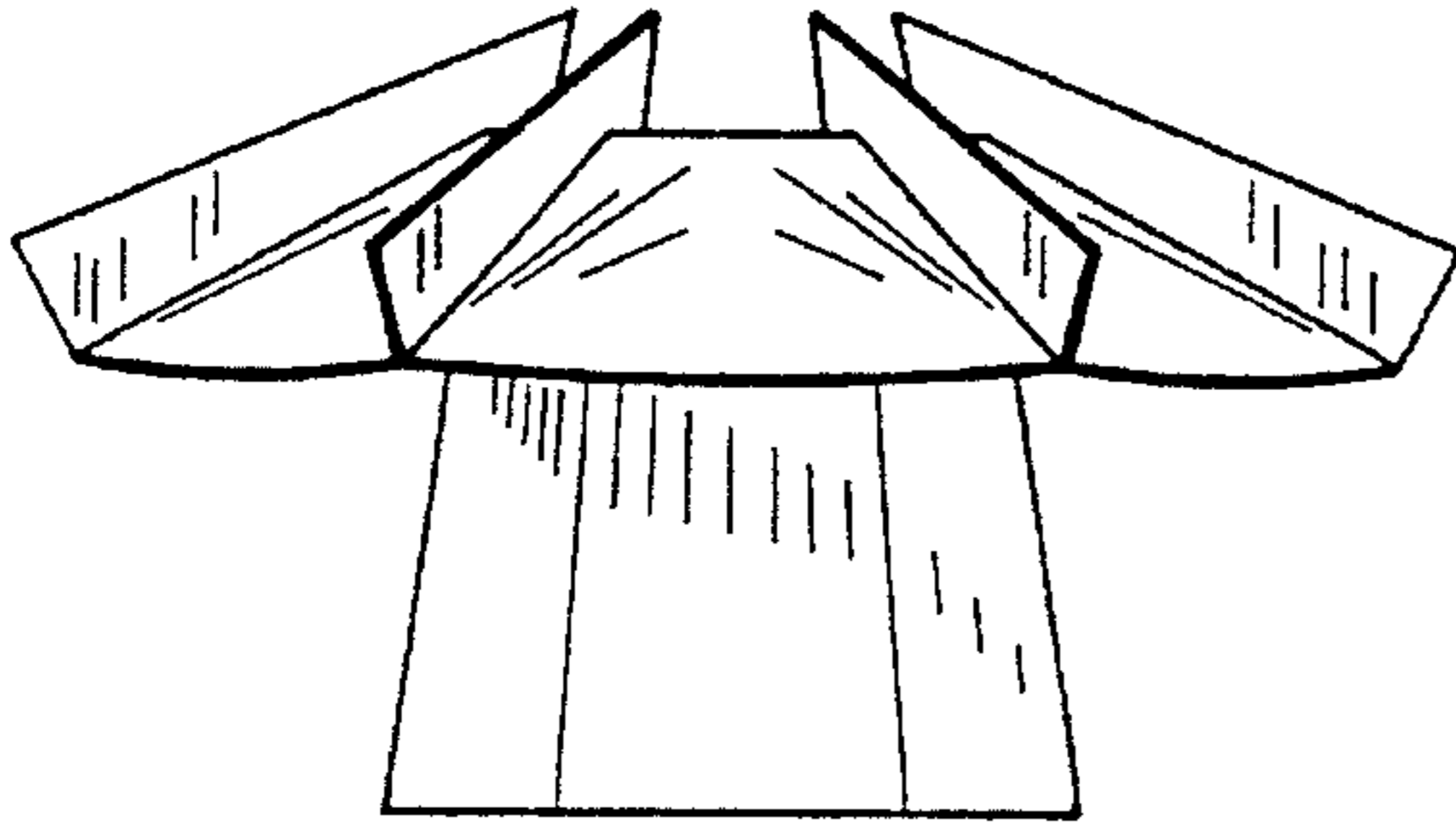

FIG. 51

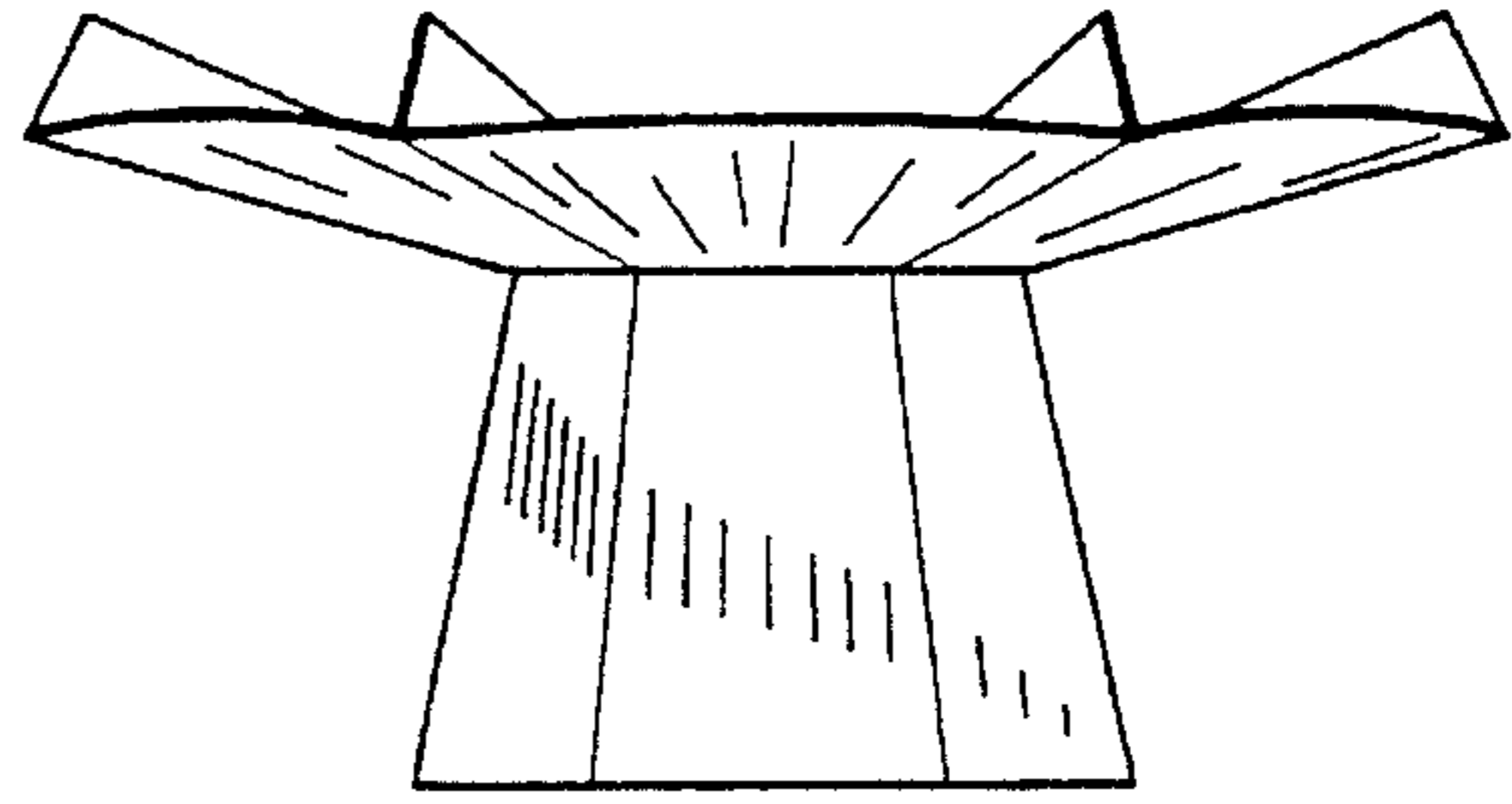

FIG. 52

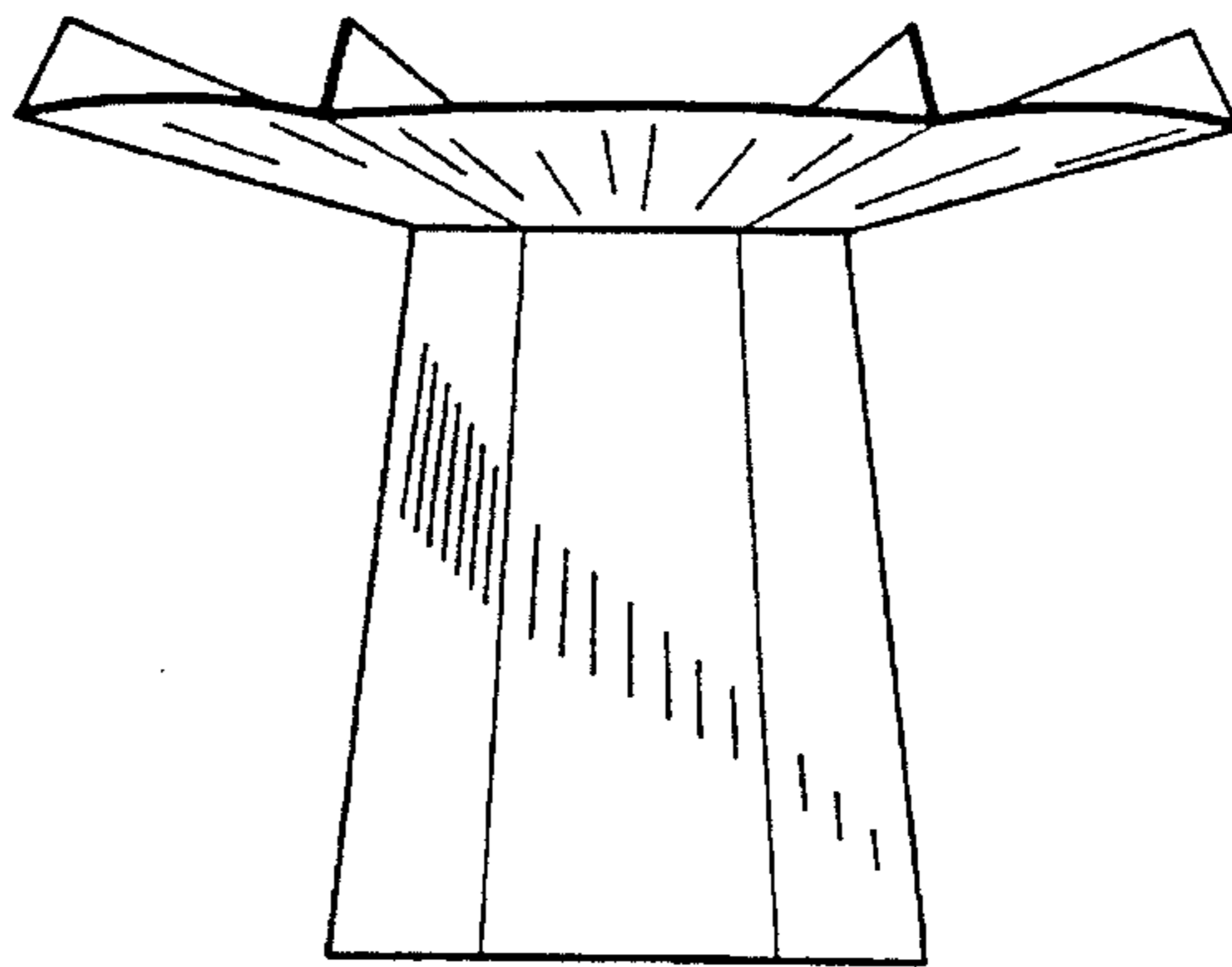

FIG. 53

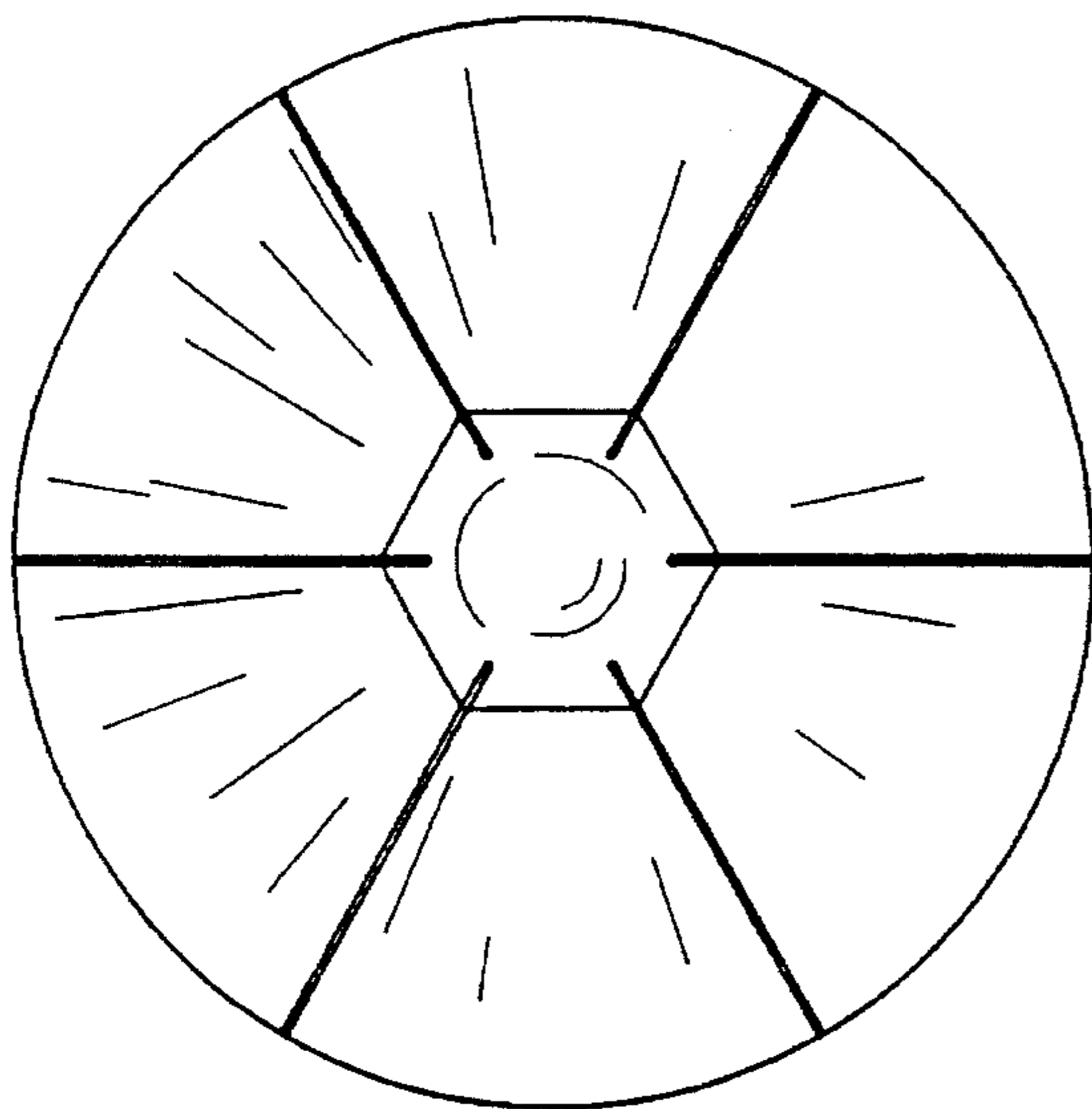

FIG. 54

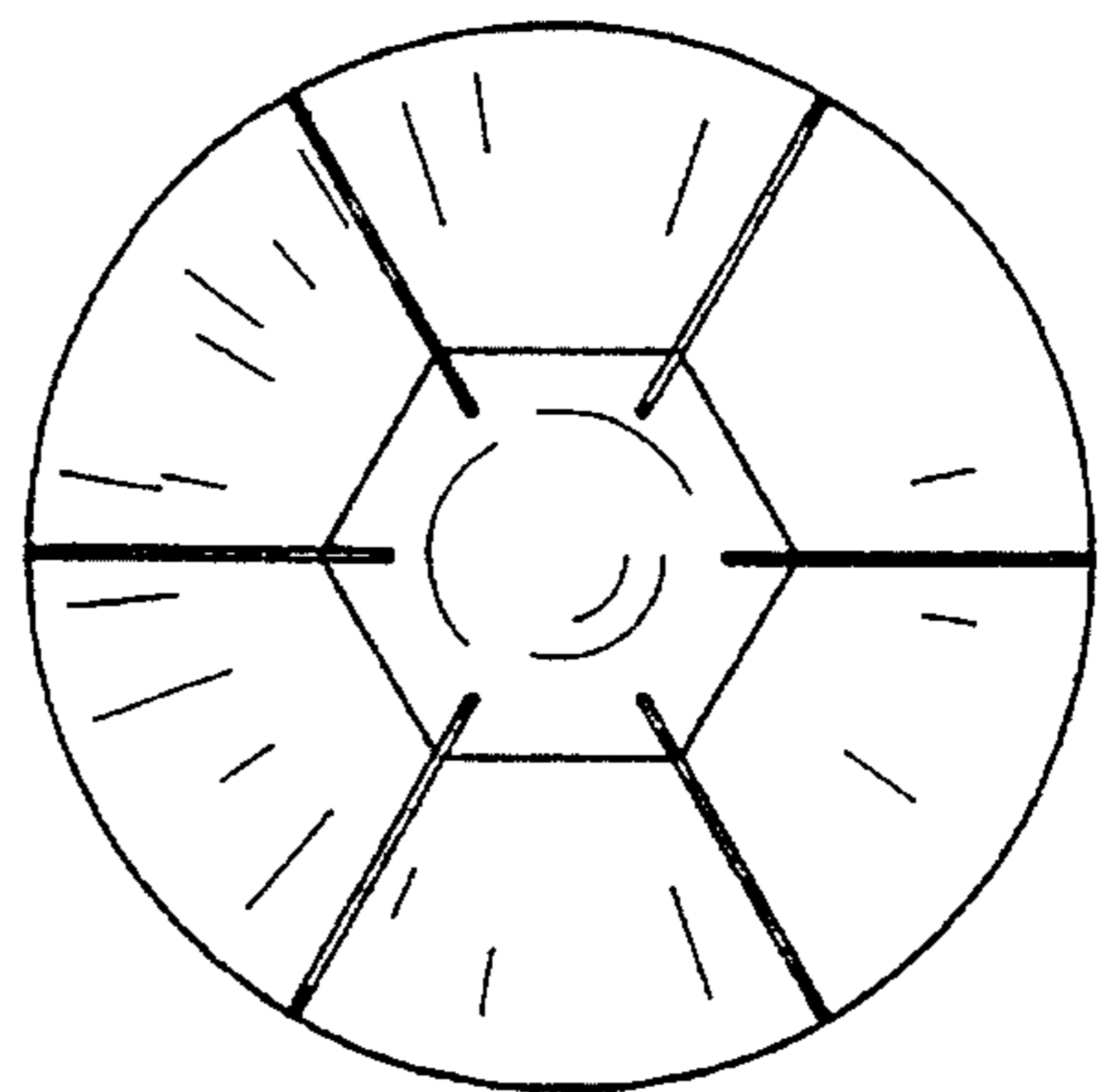
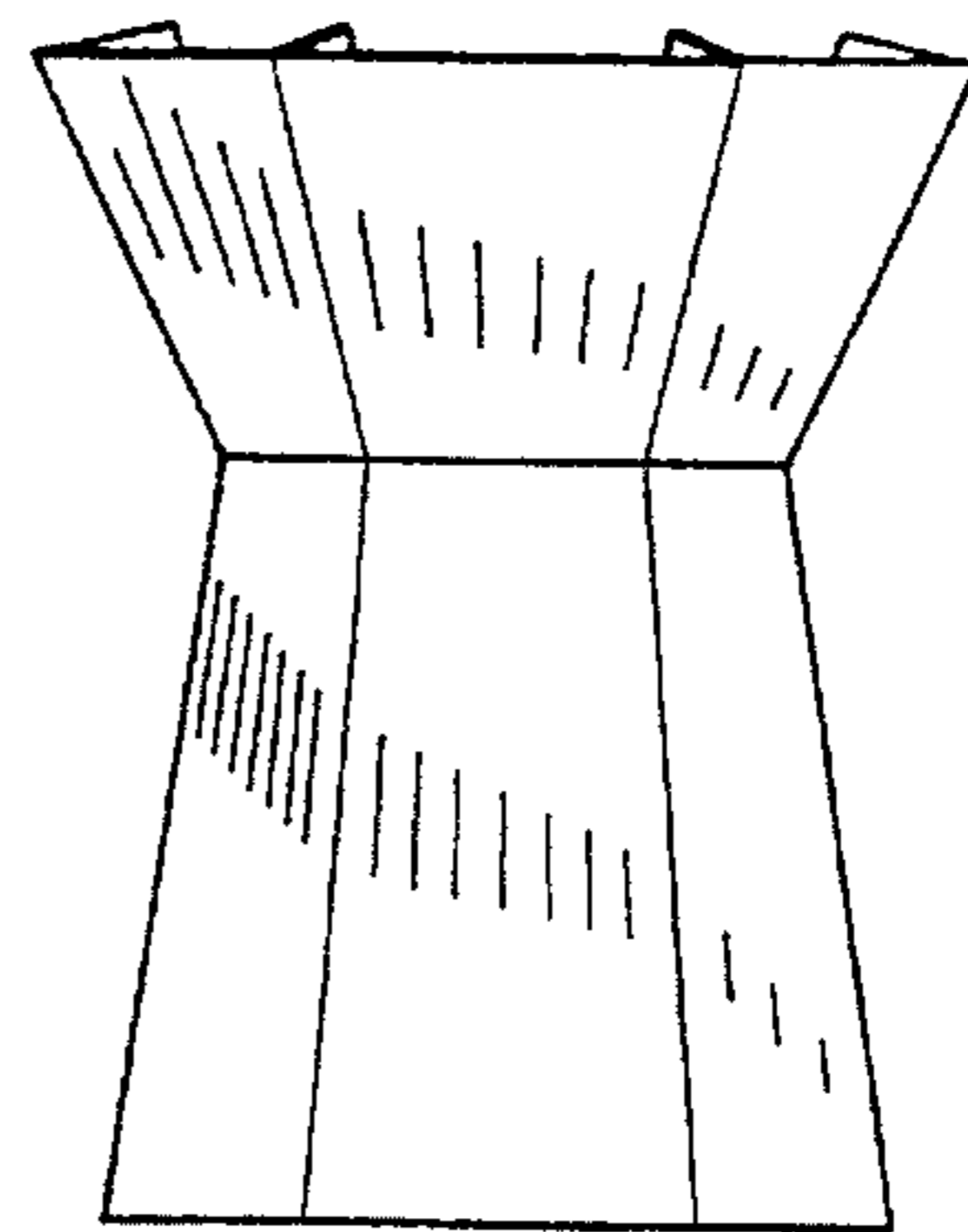
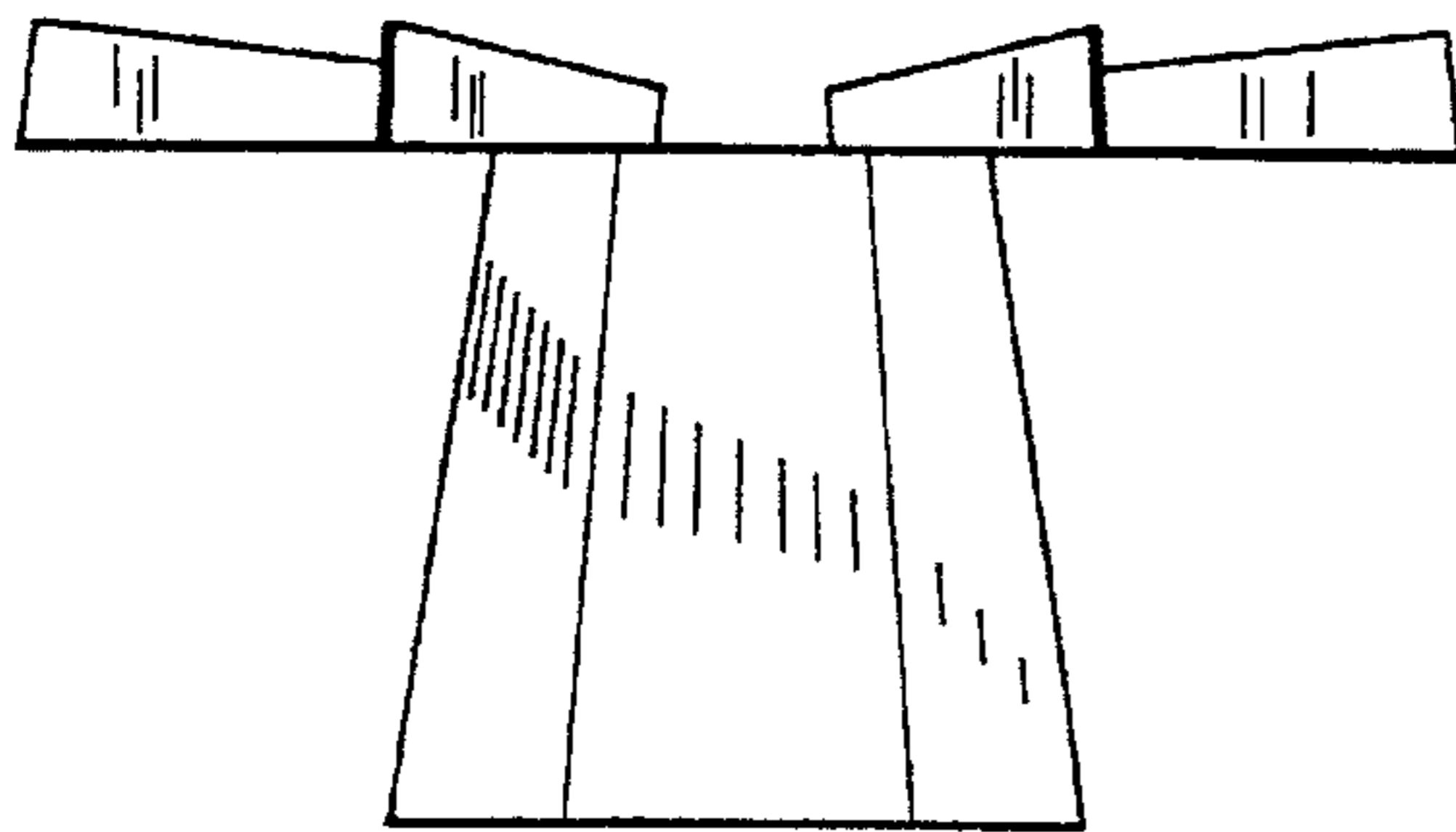
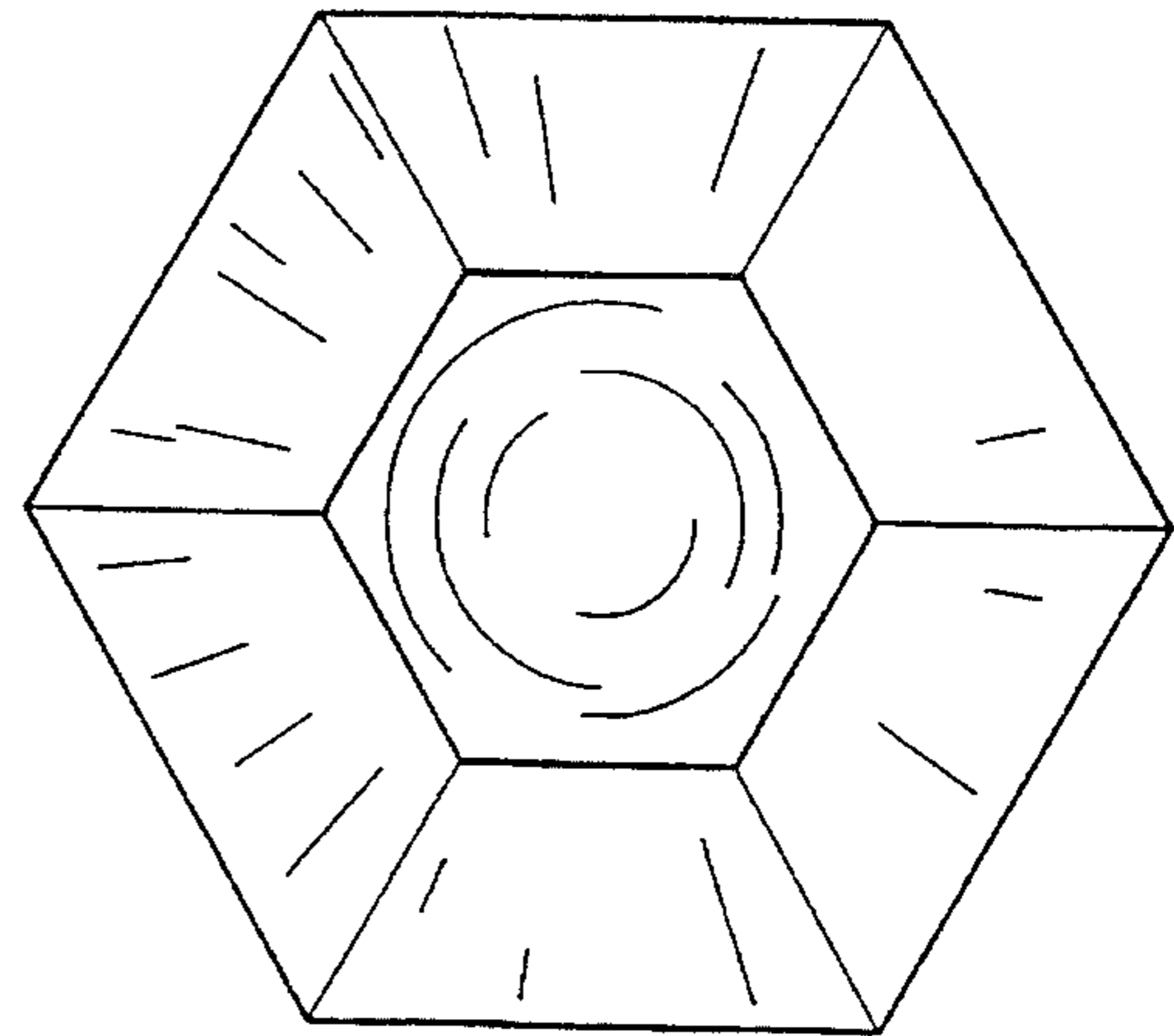
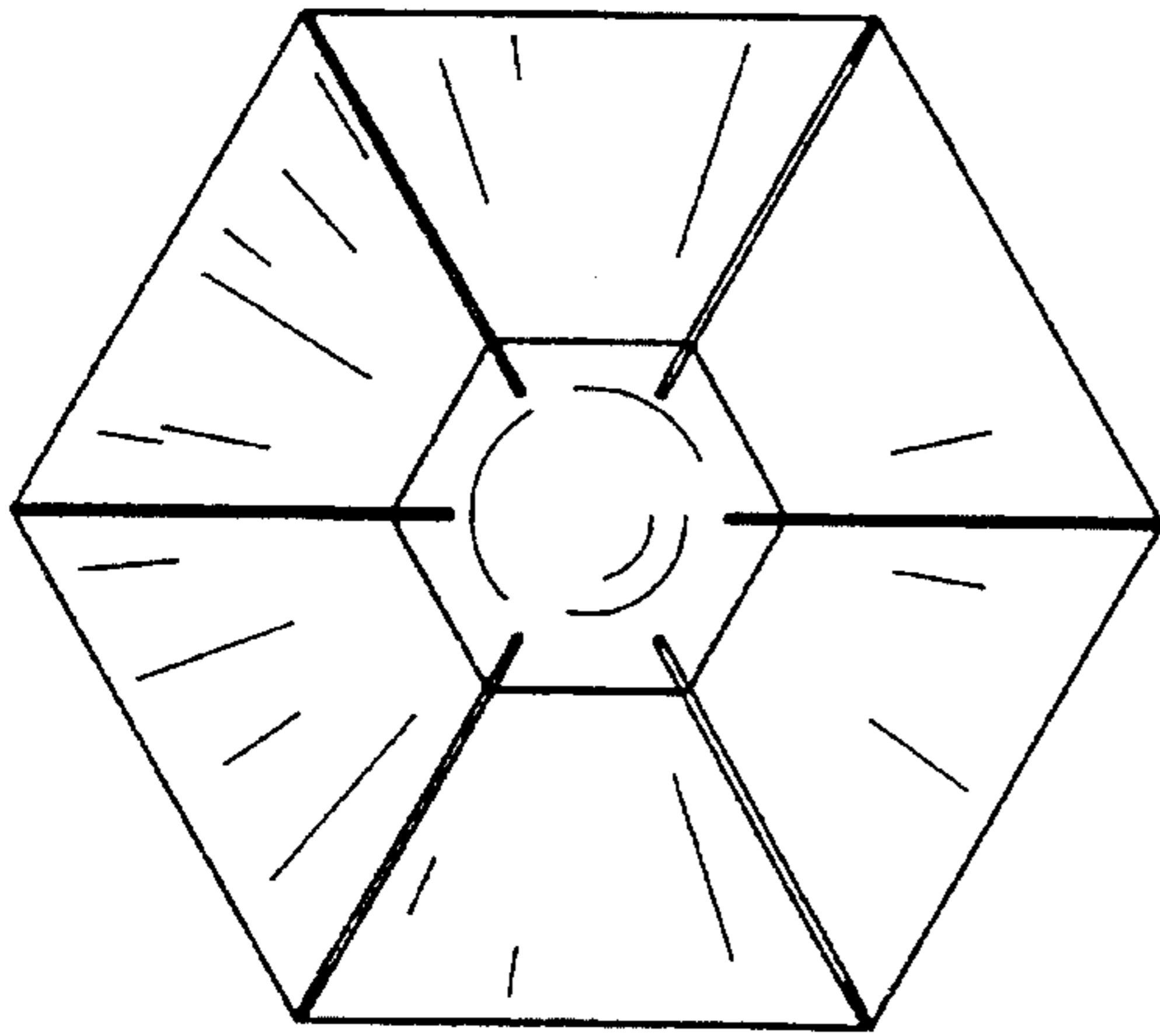
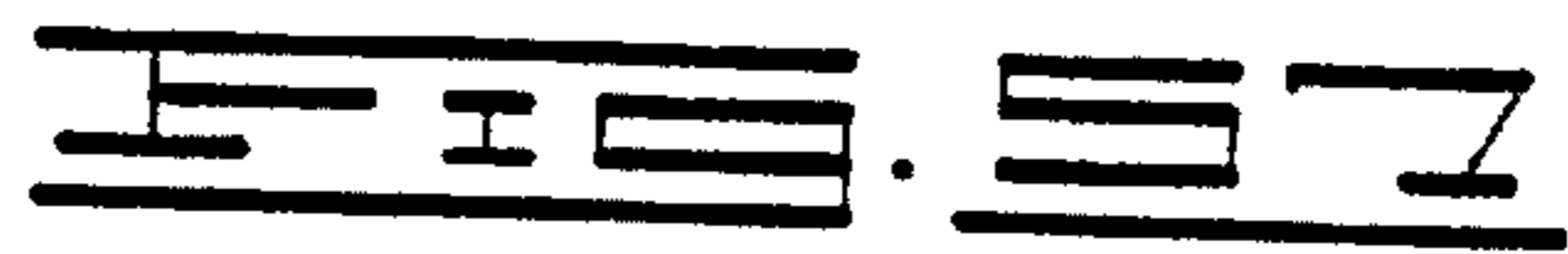
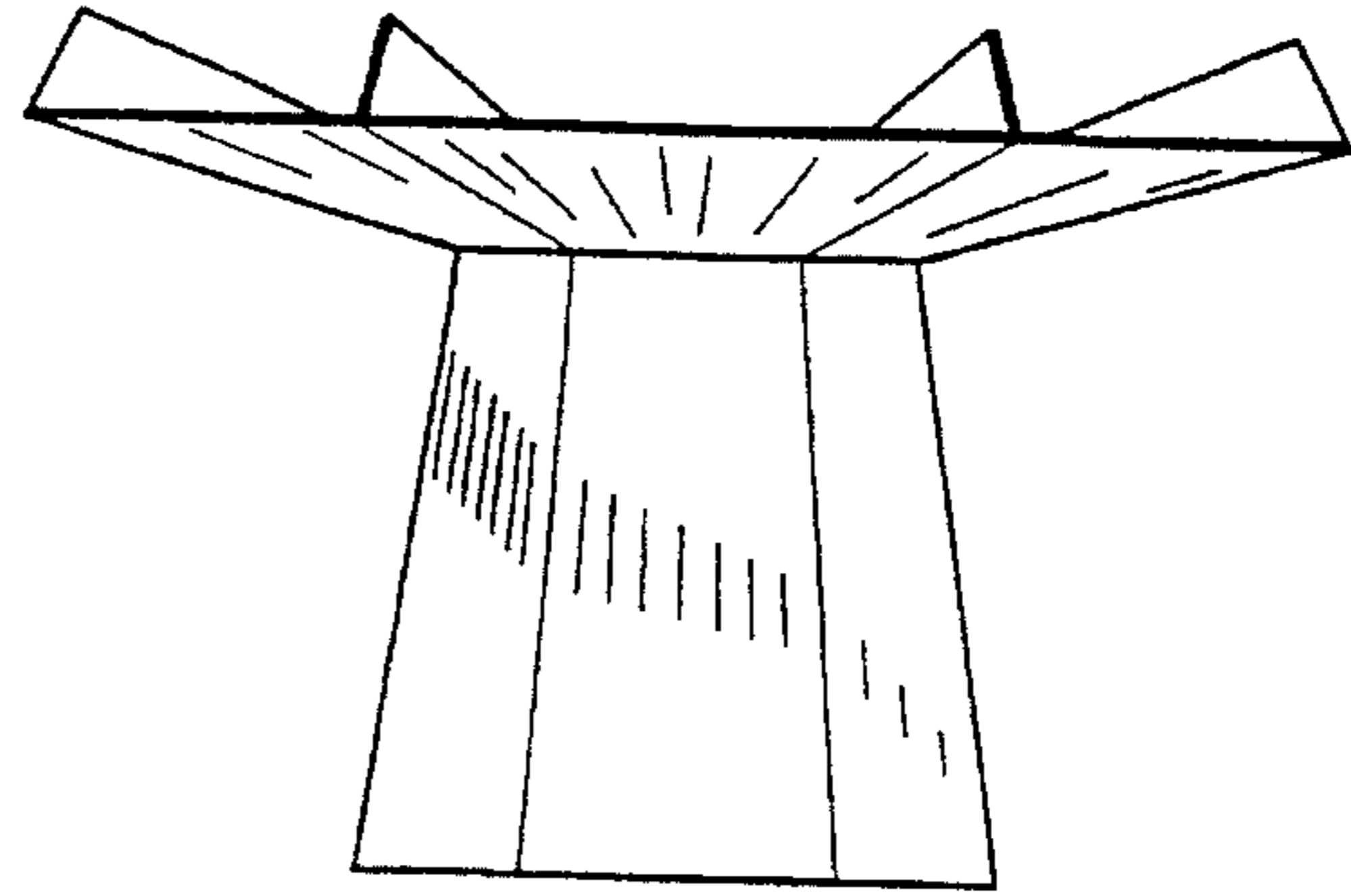
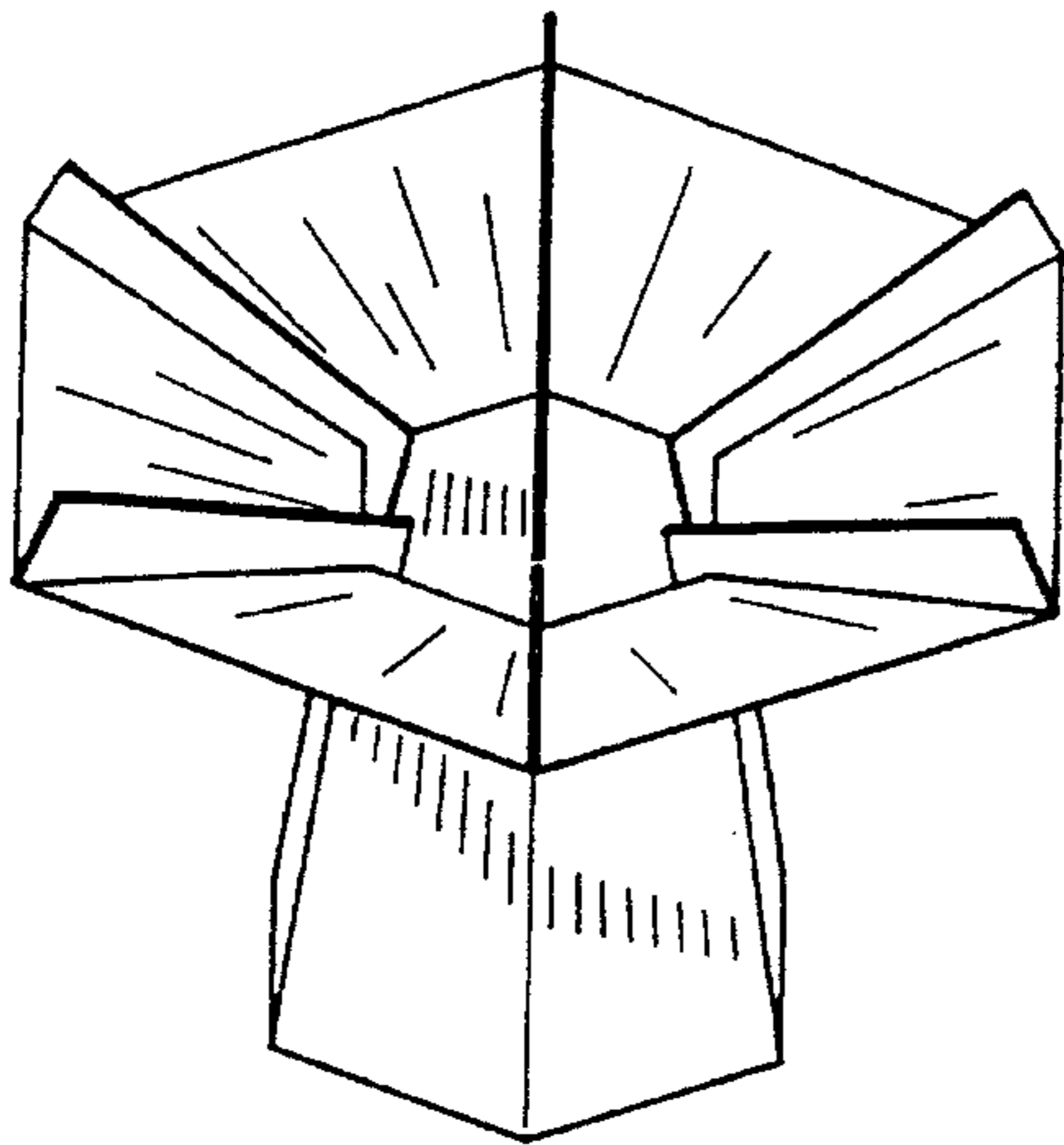

FIG. 55



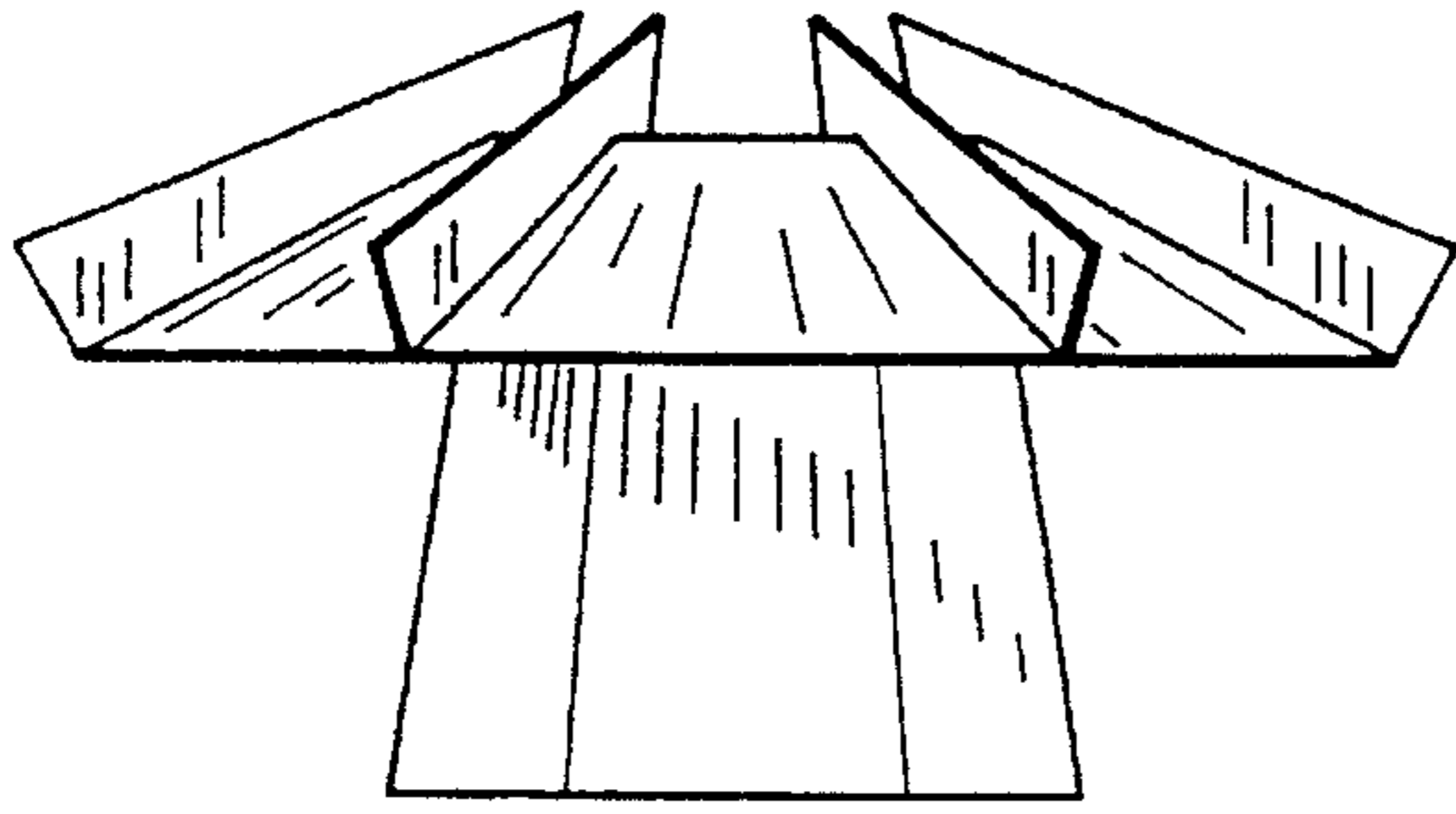

FIG. 52

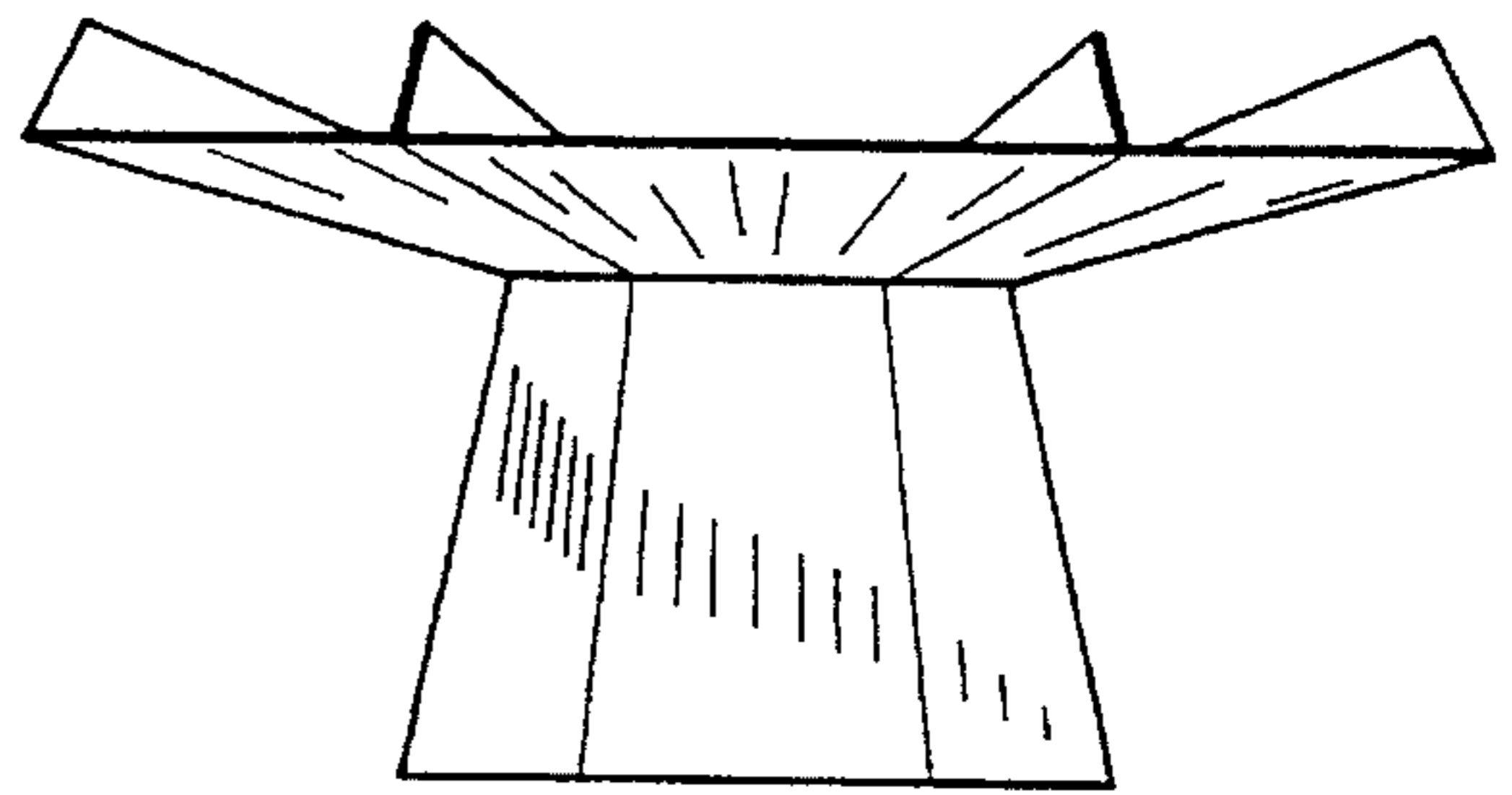

FIG. 53

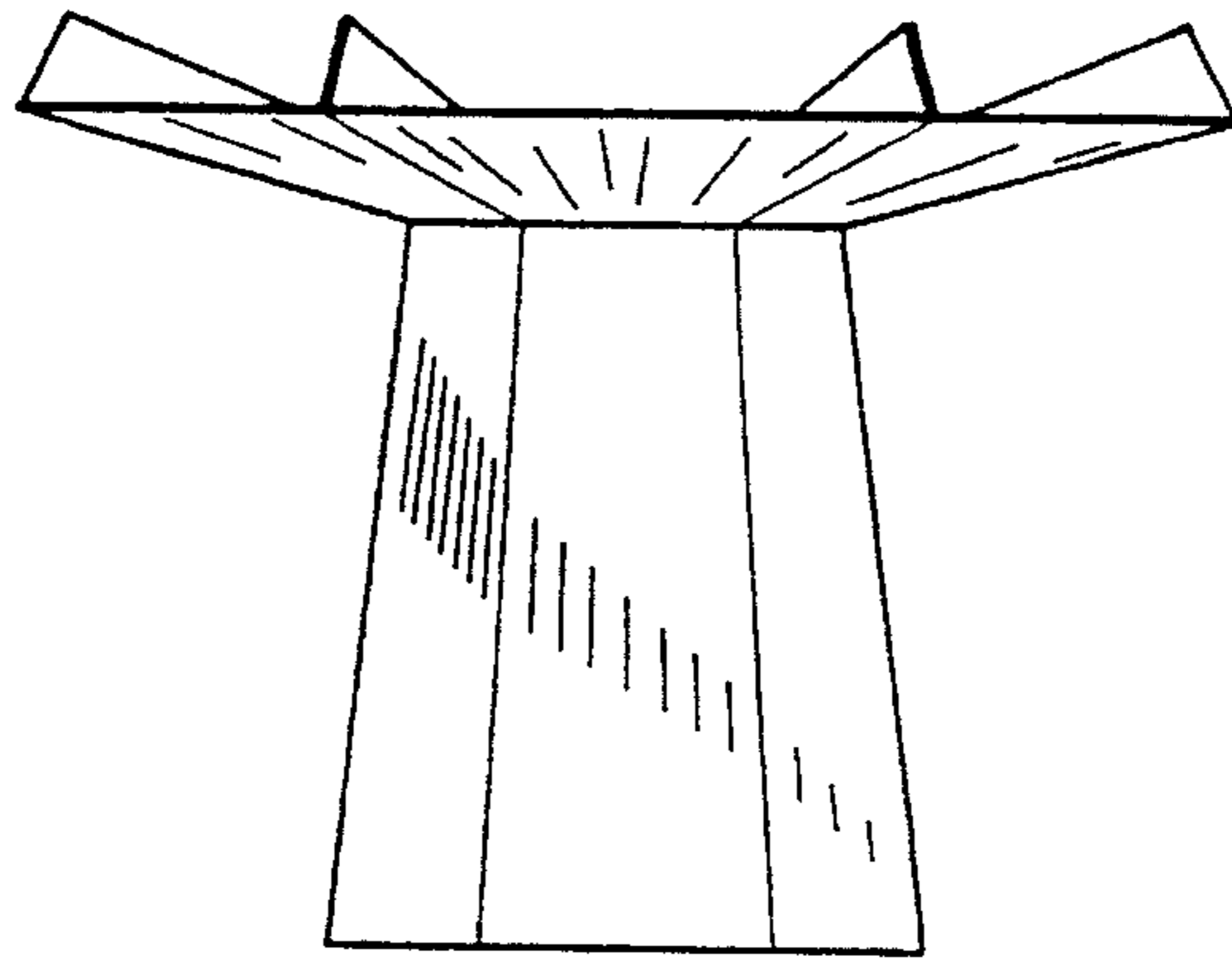

FIG. 54

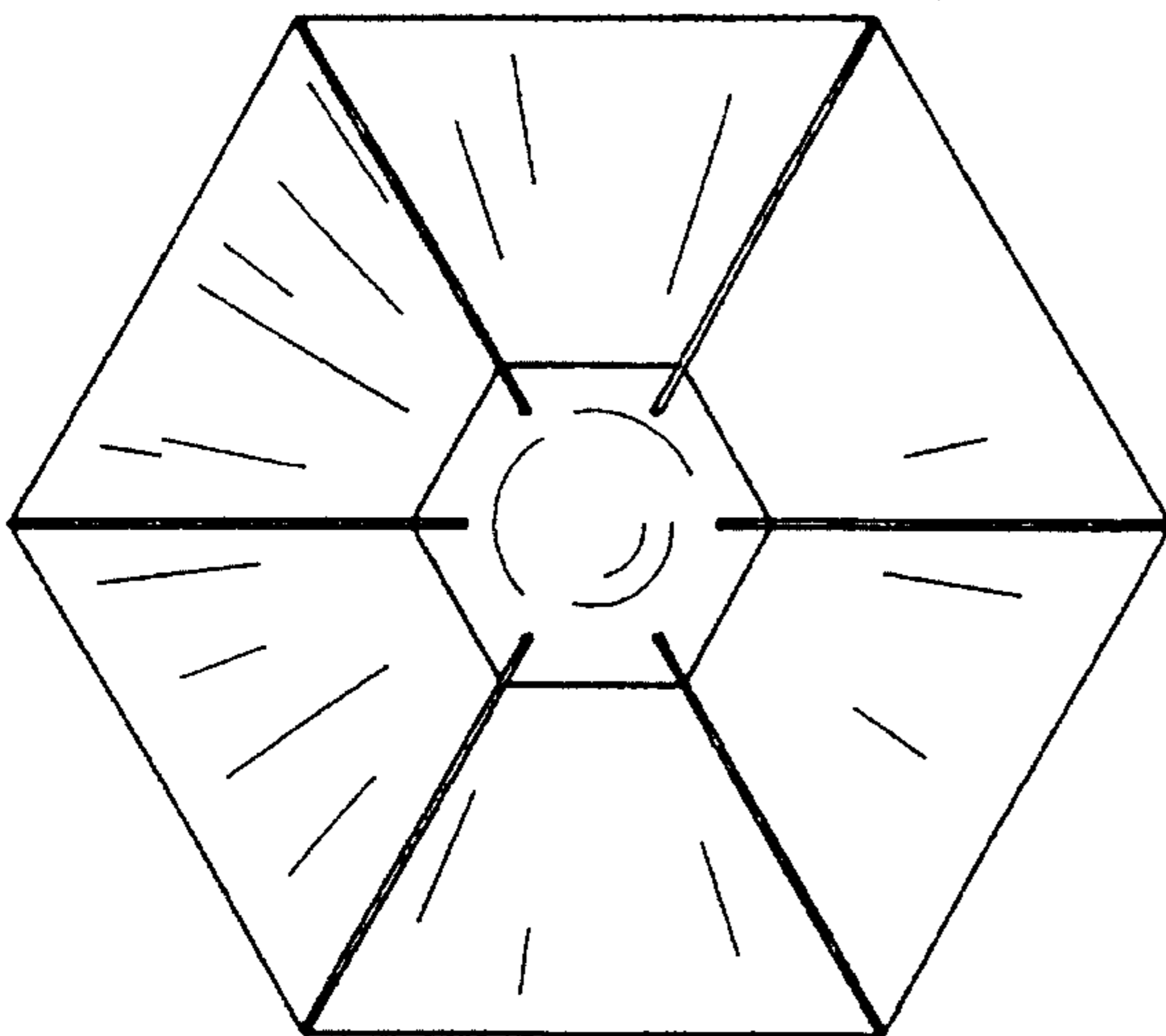

FIG. 55

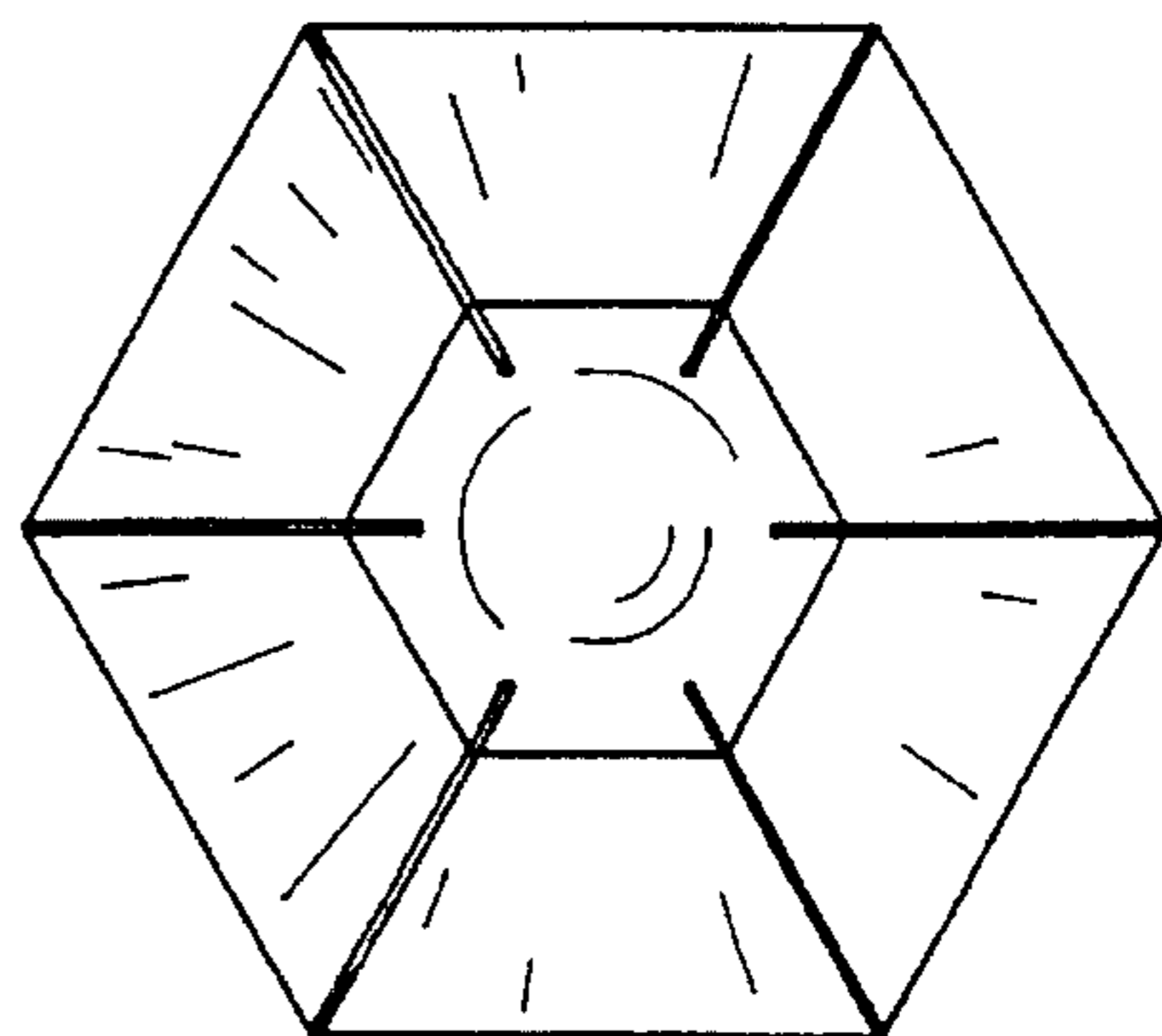

FIG. 56

UNITED STATES PATENT AND TRADEMARK OFFICE  
CERTIFICATE OF CORRECTION

PATENT NO. : Des. 369,126  
DATED : April 23, 1996  
INVENTOR(S) : Weder et al.

It is certified that error appears in the above-identified patent and that said Letters Patent is hereby corrected as shown below:

On the title page: Item [57] Description

Page 2, Description, Fig. 20, second line, after "FIG. 12" please insert --,--.

Page 2, Description, Fig. 21, second line, please delete "design, of FIG. 12" and substitute therefor --design of FIG. 12,--.

Page 2, Description, Fig. 22, second line, please delete "design, of FIG. 12" and substitute therefor --design of FIG. 12,--.

Page 2, Description, Fig. 56, second line, please delete "port" and substitute therefor --pot--.

Page 2, Description, Fig. 61, second line, please delete "rear" and substitute therefor --near--.

Page 2, Description, Fig. 66, first line, please delete "thirthieth" and substitute therefor --thirtieth--.

Signed and Sealed this  
Ninth Day of July, 1996



BRUCE LEHMAN

Commissioner of Patents and Trademarks

Attest:

Attesting Officer