



US00D369124S

United States Patent [19]

[11] Patent Number: Des. 369,124

Weder et al.

[45] Date of Patent: *** Apr. 23, 1996

[54] FLOWER POT COVER

4,712,725 12/1987 Moore 229/8
5,076,011 12/1991 Stehouwer 47/72

[75] Inventors: Donald E. Weder; Joseph G. Straeter,
both of Highland, Ill.

FOREIGN PATENT DOCUMENTS

[73] Assignee: Highland Supply Corporation,
Highland, Ill.

2489126 3/1982 France .
2603159 4/1988 France .

[*] Notice: The portion of the term of this patent
subsequent to Nov. 21, 2010, has been
disclaimed.

Primary Examiner—Jeffrey Asch
Attorney, Agent, or Firm—Dunlap & Codding

[**] Term: 14 Years

[57] CLAIM

[21] Appl. No.: 694

The ornamental design for a flower pot cover, as shown and
described.

[22] Filed: Oct. 20, 1992

DESCRIPTION

Related U.S. Application Data

[63] Continuation-in-part of Ser. No. 781,453, Oct. 21, 1991, Pat.
No. Des. 348,634, which is a continuation-in-part of Ser. No.
617,454, Nov. 21, 1990, abandoned, Ser. No. 411,249, Sep.
22, 1989, Pat. No. Des. 358,113, Ser. No. 411,247, Sep. 22,
1989, and Ser. No. 411,245, Sep. 22, 1989.

FIG. 1 is a side perspective view of our new flower pot cover
design;

FIG. 2 is a side elevational view thereof;

FIG. 3 is a top plan view thereof;

FIG. 4 is a bottom plan view thereof;

FIG. 5 is a side elevational view of the design of FIG. 1, the
only difference being in the horizontal angle of the skirt;

FIG. 6 is a side elevational view of the design of FIG. 1, the
only difference being in the near vertical angle of the skirt;

FIG. 7 is a side elevational view of the design of FIG. 1, the
only difference being in the downward angle of the skirt;

FIG. 8 is a side elevational view of a second embodiment of
the design of FIG. 1, the only difference being in the height
of the base;

FIG. 9 is a side elevational view of a third embodiment of
the design of FIG. 1, the only difference being in the height
of the base;

FIG. 10 is a top plan view of a fourth embodiment of the
design of FIG. 1, the only difference being in the size of the
skirt;

FIG. 11 is a top plan view of a fifth embodiment of the
design of FIG. 1, the only difference being in the size of the
skirt;

FIG. 12 is a perspective view of a sixth embodiment of our
new flower pot cover design;

FIG. 13 is a side elevational view thereof;

FIG. 14 is a top plan view thereof;

FIG. 15 is a bottom plan view thereof;

FIG. 16 is a side elevational view of the design of FIG. 12,
the only difference being in the horizontal angle of the skirt;

FIG. 17 is a side elevational view of the design of FIG. 12,

[52] U.S. Cl. D11/164; D11/143

[58] Field of Search D11/143, 149,
D11/152-156, 164, 89, 90; 47/66, 72; 206/423;
215/100.5; 229/1.5 R, 1.5 B, 4.5, 87.01,
922, 930, 108, 108.1, 109, 110; 428/27,
35.1, 24, 542.6; D9/346, 428-431; D27/102,
133; D26/128-136; D19/96; D7/540, 584,
586, 587, 354

[56] References Cited

U.S. PATENT DOCUMENTS

D. 239,192	3/1976	Wiles et al.	D35/3 A
D. 254,659	4/1980	Karotseris	D11/143
D. 319,417	8/1991	Weder et al.	D11/164
D. 322,403	12/1991	Eaton	D9/429
D. 324,659	3/1992	Stehouwer	D11/164
D. 327,234	6/1992	Vaughn	D11/143
D. 336,041	6/1993	Zama	D9/429
D. 348,634	7/1994	Weder et al.	D11/164
1,951,642	8/1932	Augustin et al.	47/32
3,253,768	3/1958	Gjesdal	D9/431 X
3,443,741	5/1969	Stockdale	D9/431 X
4,043,077	8/1977	Stonehocker	47/36

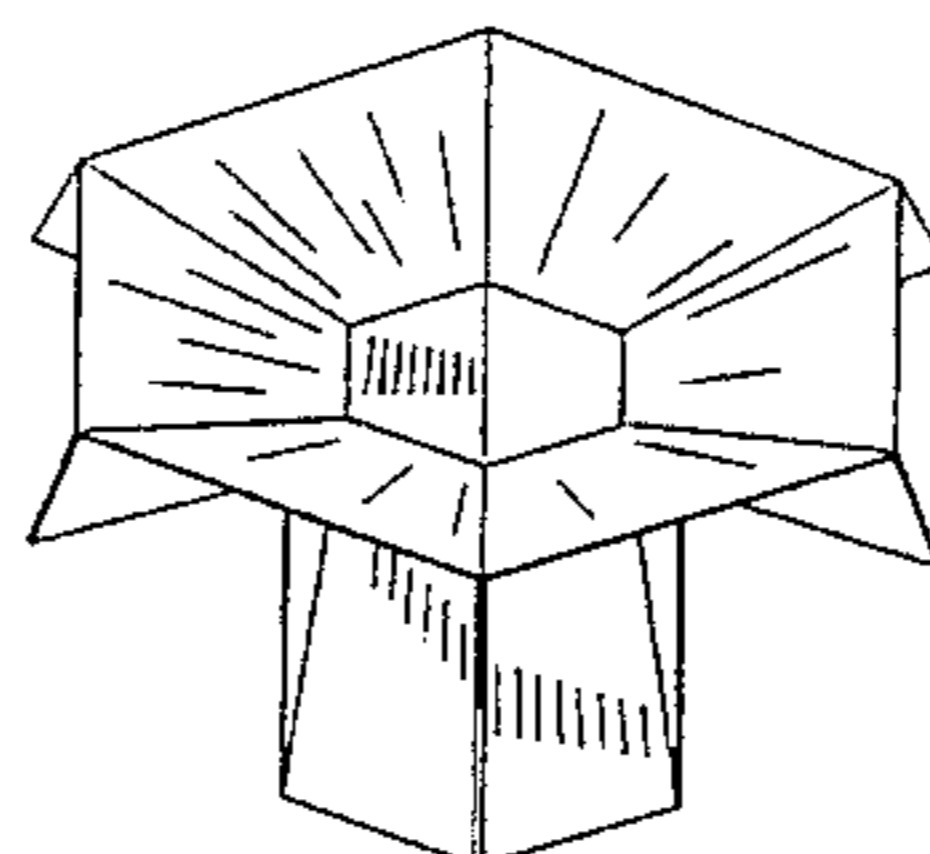
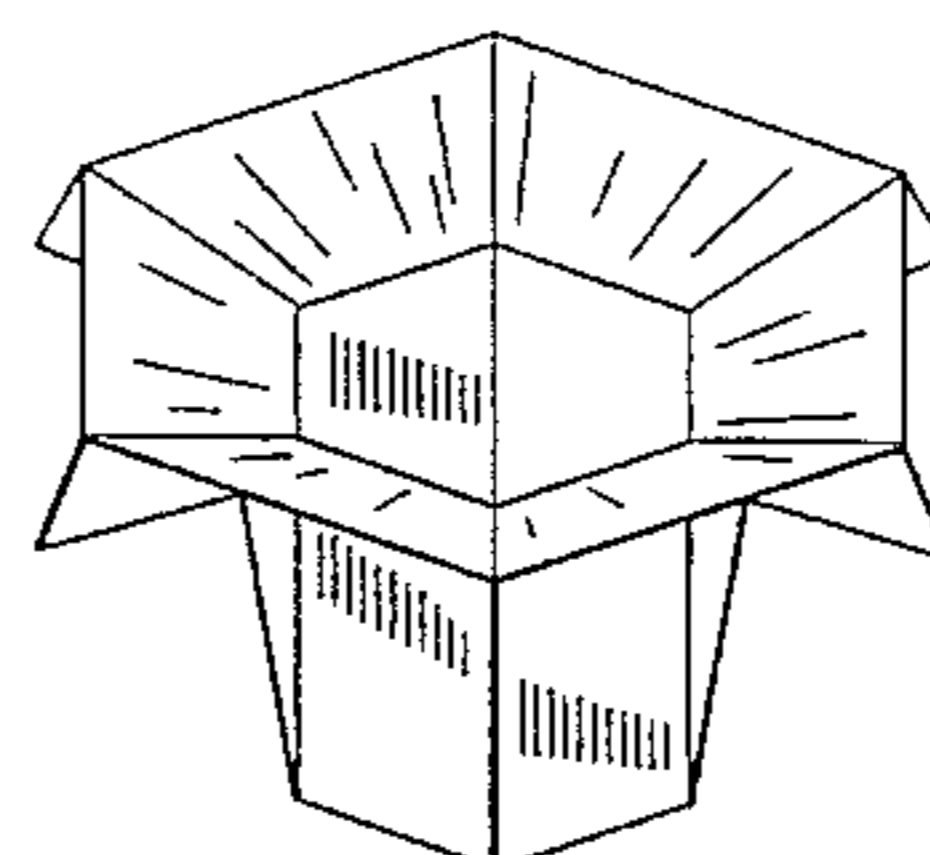
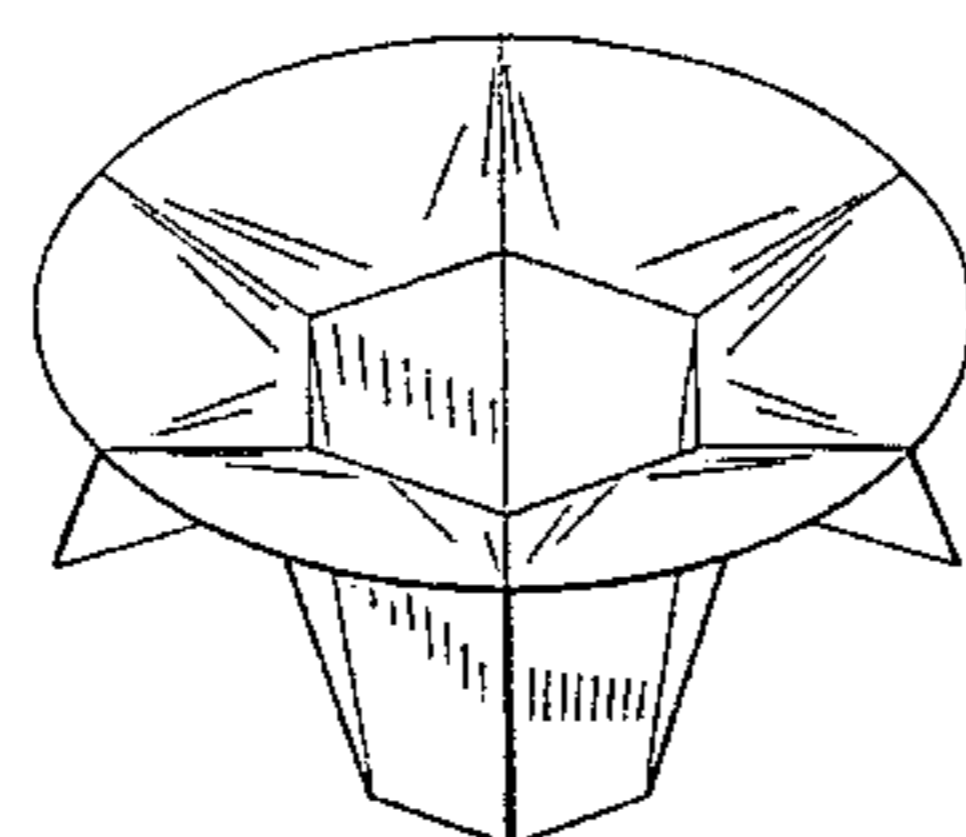

the only difference being in the near vertical angle of the skirt;

FIG. 18 is a side elevational view of the design of FIG. 12, the only difference being in the downward angle of the skirt;

FIG. 19 is a side elevational view of a seventh embodiment of the flower pot cover design of FIG. 12, the only difference being in the height of the base;

FIG. 20 is a side elevational view of an eighth embodiment of the new flower pot cover design of FIG. 12, the only difference being in the height of the base;

FIG. 21 is a top plan view of a ninth embodiment of the flower pot cover design of FIG. 12, the only difference being in the size of the skirt;

FIG. 22 is a top plan view of a tenth embodiment of the flower pot cover design of FIG. 12, the only difference being in the size of the skirt;

FIG. 23 is a perspective view of an eleventh embodiment of our new flower pot cover design;

FIG. 24 is a side elevational view thereof;

FIG. 25 is a top plan view thereof;

FIG. 26 is a bottom plan view thereof;

FIG. 27 is a side elevational view of the design of FIG. 23, the only difference being in the horizontal angle of the skirt;

FIG. 28 is a side elevational view of the design of FIG. 23, the only difference being in the near vertical angle of the skirt;

FIG. 29 is a side elevational view of the design of FIG. 23, the only difference being in the downward angle of the skirt;

FIG. 30 is a side elevational view of a twelfth embodiment of the flower pot cover design of FIG. 23, the only difference being in the height of the base;

FIG. 31 is a side elevational view of a thirteenth embodiment of the new flower pot cover design of FIG. 23, the only difference being in the height of the base;

FIG. 32 is a top plan view of a fourteenth embodiment of the flower pot cover design of FIG. 23, the only difference being in the size of the skirt;

FIG. 33 is a top plan view of a fifteenth embodiment of the flower pot cover design of FIG. 23, the only difference being in the size of the skirt;

FIG. 34 is a perspective view of a sixteenth embodiment of our new flower pot cover design;

FIG. 35 is a side elevational view thereof;

FIG. 36 is a top plan view thereof;

FIG. 37 is a bottom plan view thereof;

FIG. 38 is a side elevational view of the design of FIG. 34, the only difference being in the horizontal angle of the skirt;

FIG. 39 is a side elevational view of the design of FIG. 34, the only difference being in the near vertical angle of the skirt;

FIG. 40 is a side elevational view of the design of FIG. 34, the only difference being in the downward angle of the skirt;

FIG. 41 is a side elevational view of a seventeenth embodiment of the flower pot cover design of FIG. 34, the only difference being in the height of the base;

FIG. 42 is a side elevational view of an eighteenth embodiment of the new flower pot cover design of FIG. 34, the only difference being in the height of the base;

FIG. 43 is a top plan view of a nineteenth embodiment of the flower pot cover design of FIG. 34, the only difference being in the size of the skirt;

FIG. 44 is a top plan view of a twentieth embodiment of the flower pot cover design of FIG. 34, the only difference being in the size of the skirt;

FIG. 45 is a perspective view of a twenty-first embodiment of our new flower pot cover design;

FIG. 46 is a side elevational view thereof;

FIG. 47 is a top plan view thereof;

FIG. 48 is a bottom plan view thereof;

FIG. 49 is a side elevational view of the design of FIG. 45, the only difference being in the horizontal angle of the skirt;

FIG. 50 is a side elevational view of the design of FIG. 45, the only difference being in the near vertical angle of the skirt;

FIG. 51 is a side elevational view of the design of FIG. 45, the only difference being in the downward angle of the skirt;

FIG. 52 is a side elevational view of a twenty-second embodiment of the flower pot cover design of FIG. 45, the only difference being in the height of the base;

FIG. 53 is a side elevational view of a twenty-third embodiment of the new flower pot cover design of FIG. 45, the only difference being in the height of the base;

FIG. 54 is a top plan view of a twenty-fourth embodiment of the flower pot cover design of FIG. 45, the only difference being in the size of the skirt;

FIG. 55 is a top plan view of a twenty-fifth embodiment of the flower pot cover design of FIG. 45, the only difference being in the size of the skirt;

FIG. 56 is a perspective view of a twenty-sixth embodiment of our new flower pot cover design;

FIG. 57 is a side elevational view thereof;

FIG. 58 is a top plan view thereof;

FIG. 59 is a bottom plan view thereof;

FIG. 60 is a side elevational view of the design of FIG. 56, the only difference being in the horizontal angle of the skirt;

FIG. 61 is a side elevational view of the design of FIG. 56, the only difference being in the near vertical angle of the skirt;

FIG. 62 is a side elevational view of the design of FIG. 56, the only difference being in the downward angle of the skirt;

FIG. 63 is a side elevational view of a twenty-seventh embodiment of the flower pot cover design of FIG. 56, the only difference being in the height of the base;

FIG. 64 is a side elevational view of a twenty-eighth embodiment of the new flower pot cover design of FIG. 56, the only difference being in the height of the base;

FIG. 65 is a top plan view of a twenty-ninth embodiment of the flower pot cover design of FIG. 56, the only difference being in the size of the skirt;

FIG. 66 is a top plan view of a thirtieth embodiment of the flower pot cover design of FIG. 56, the only difference being in the size of the skirt.

The flower pot cover has no substantial thickness.

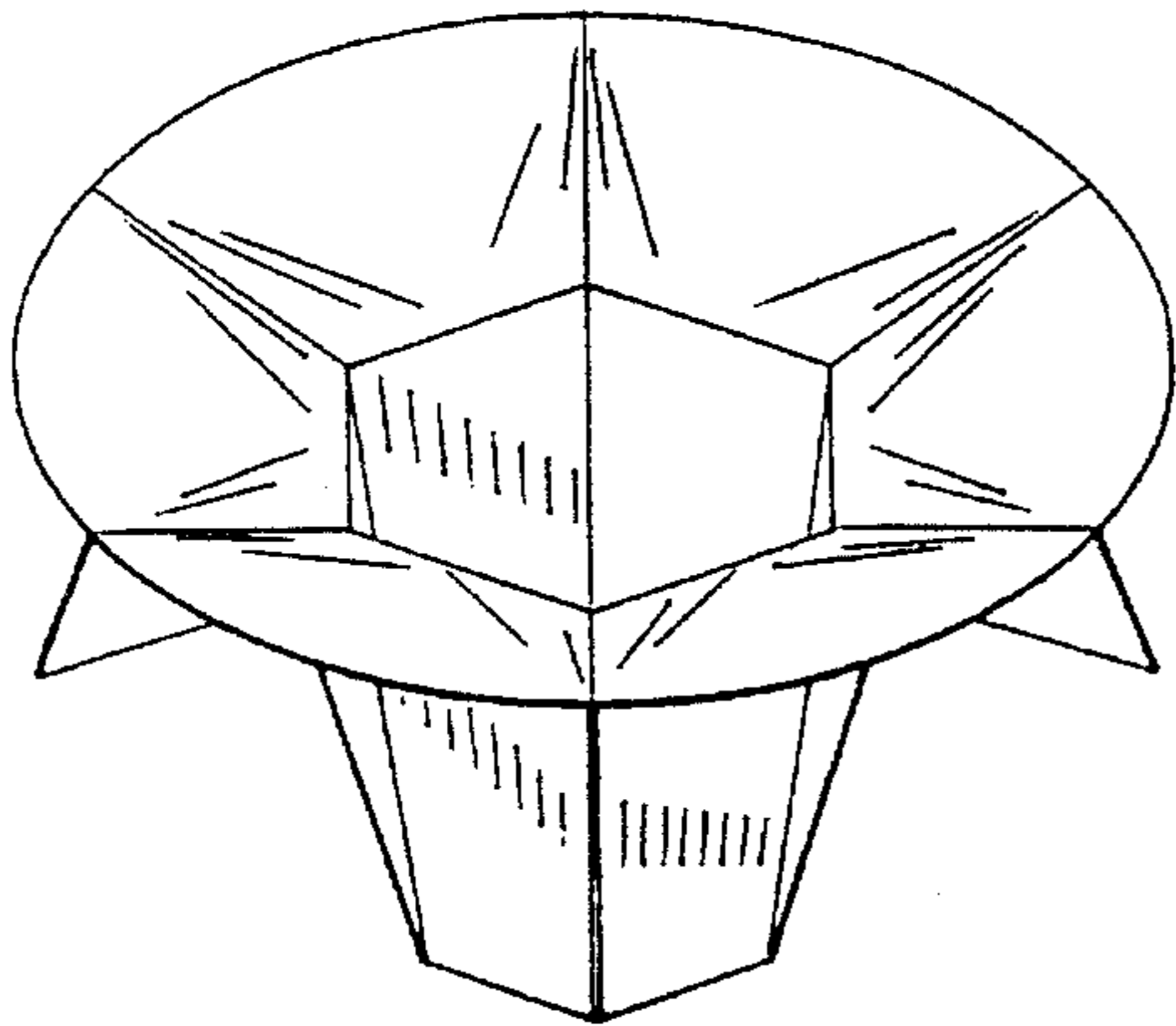

FIG. 1

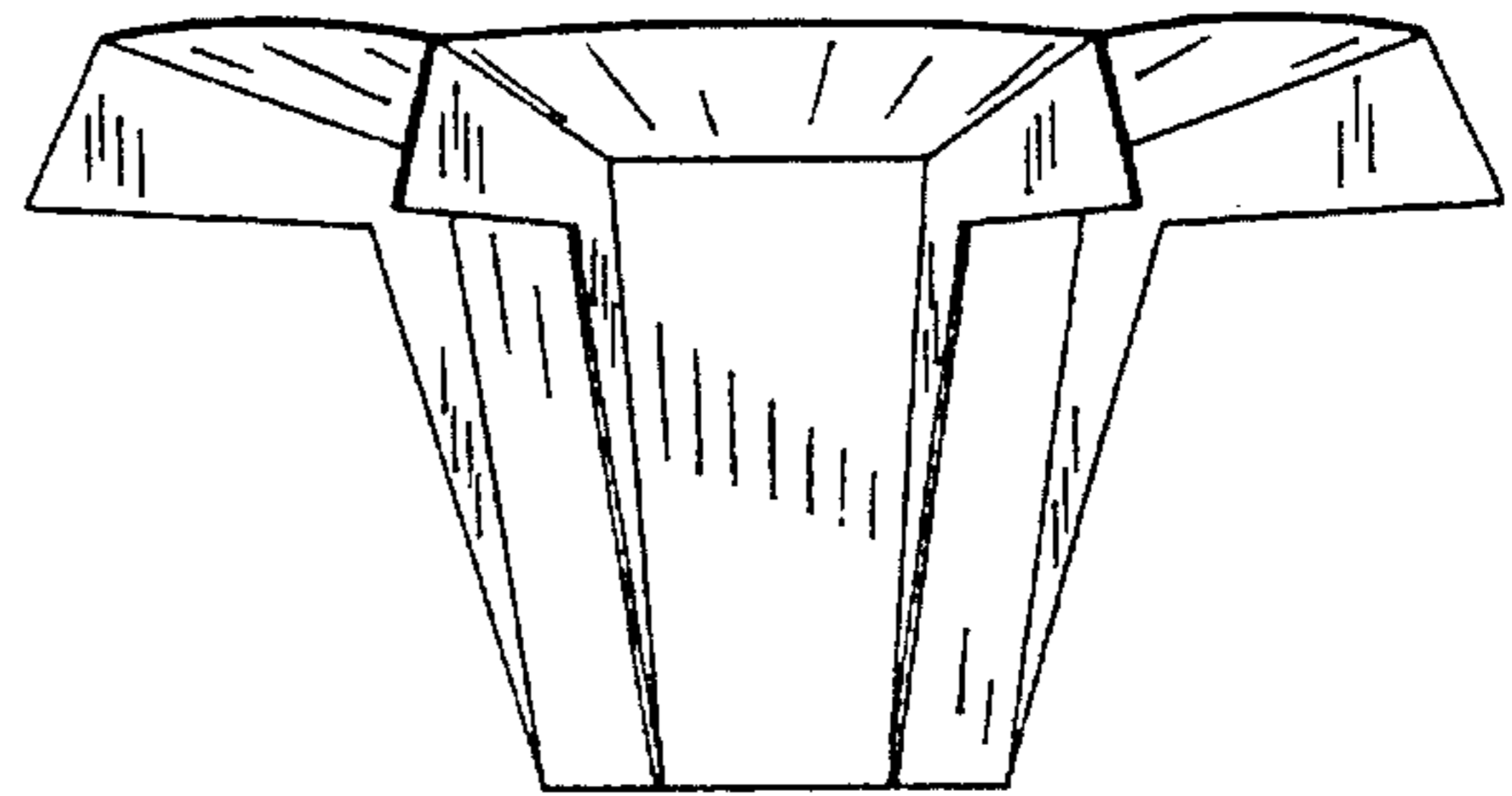

FIG. 2

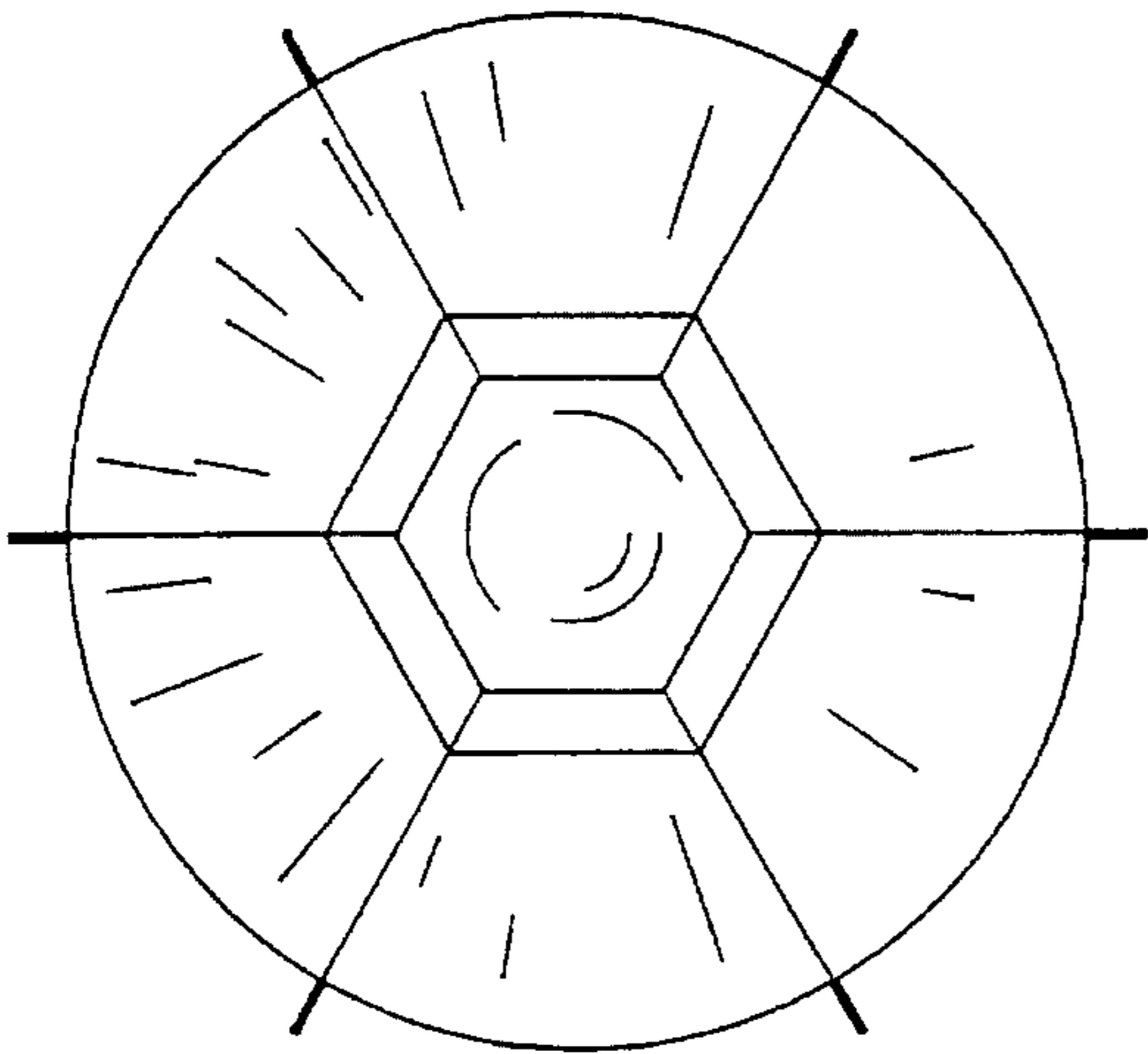

FIG. 3

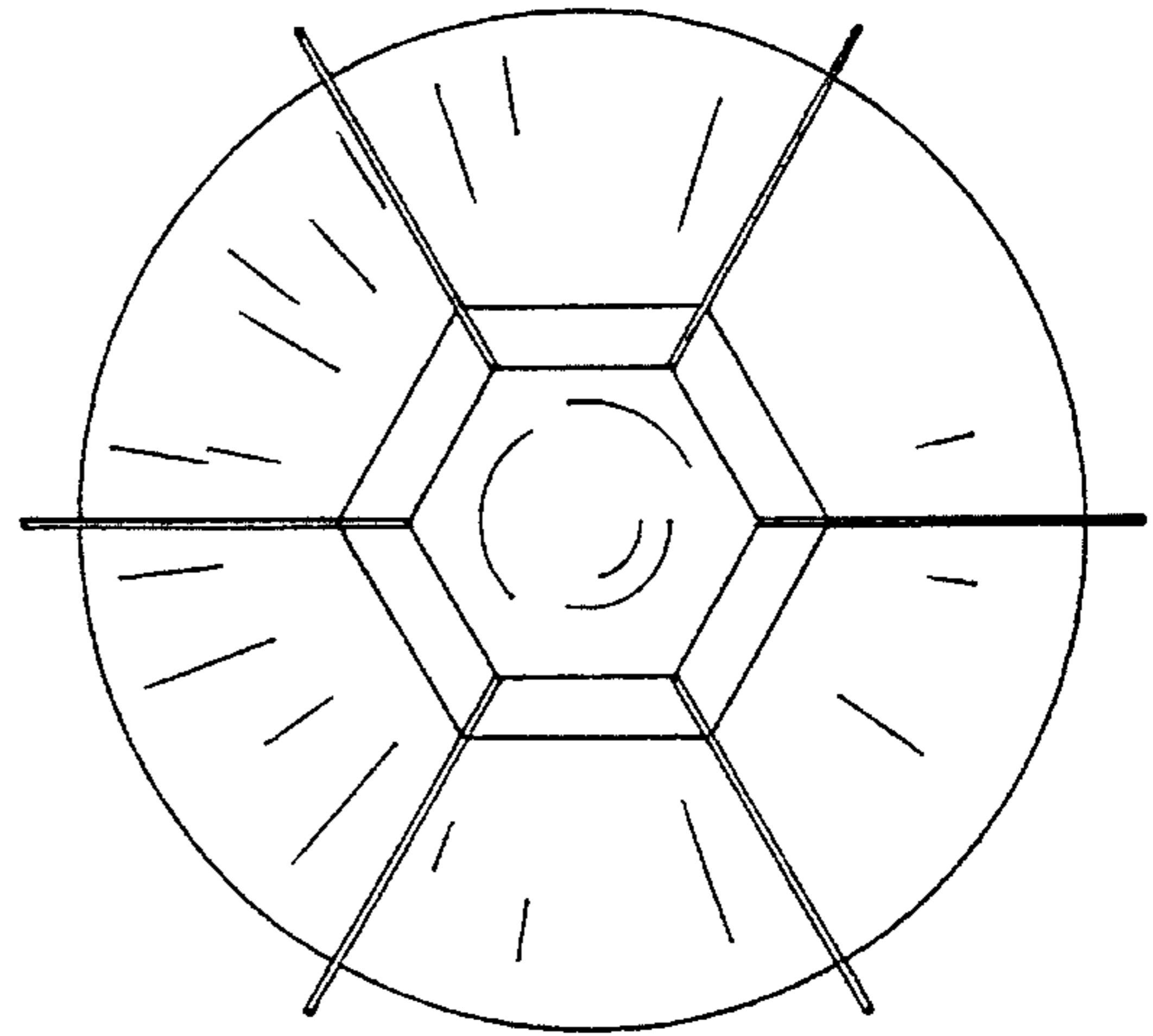

FIG. 4

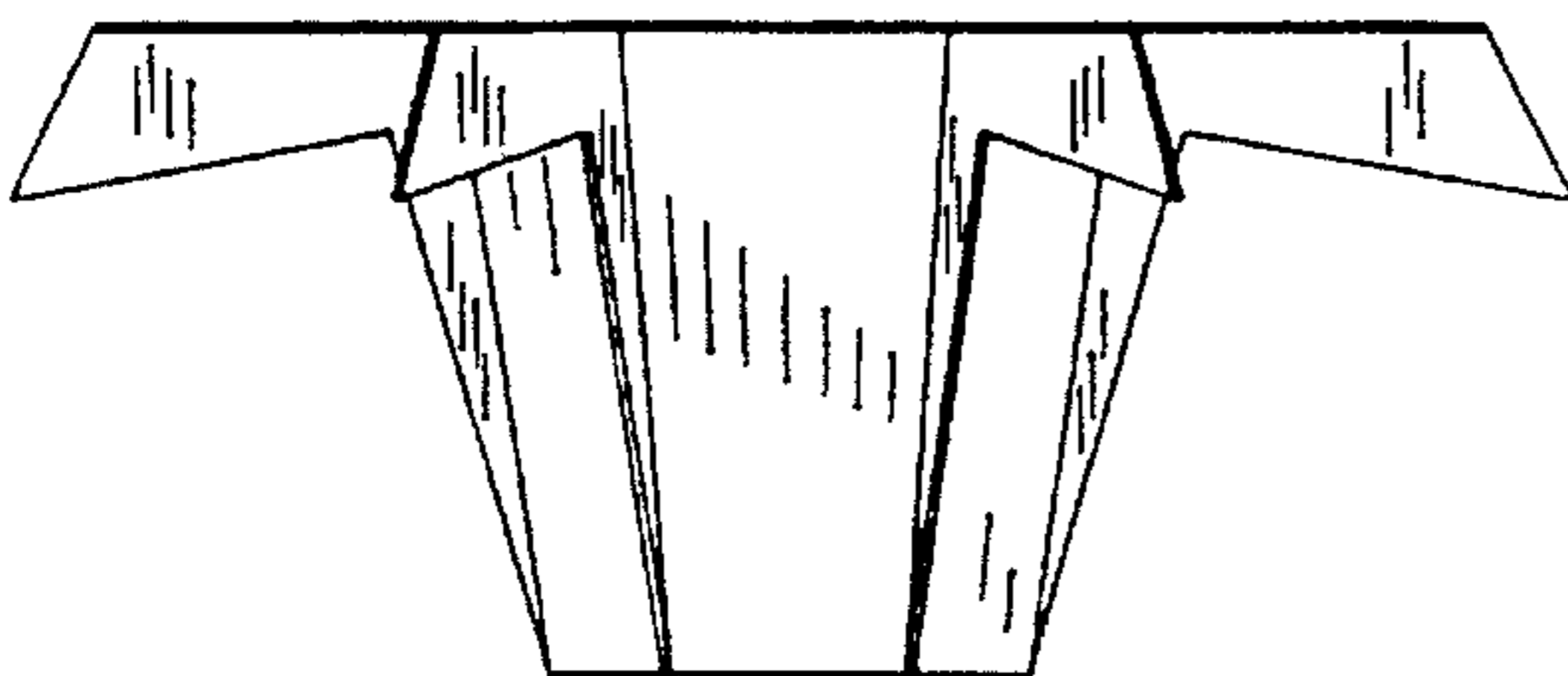

FIG. 5

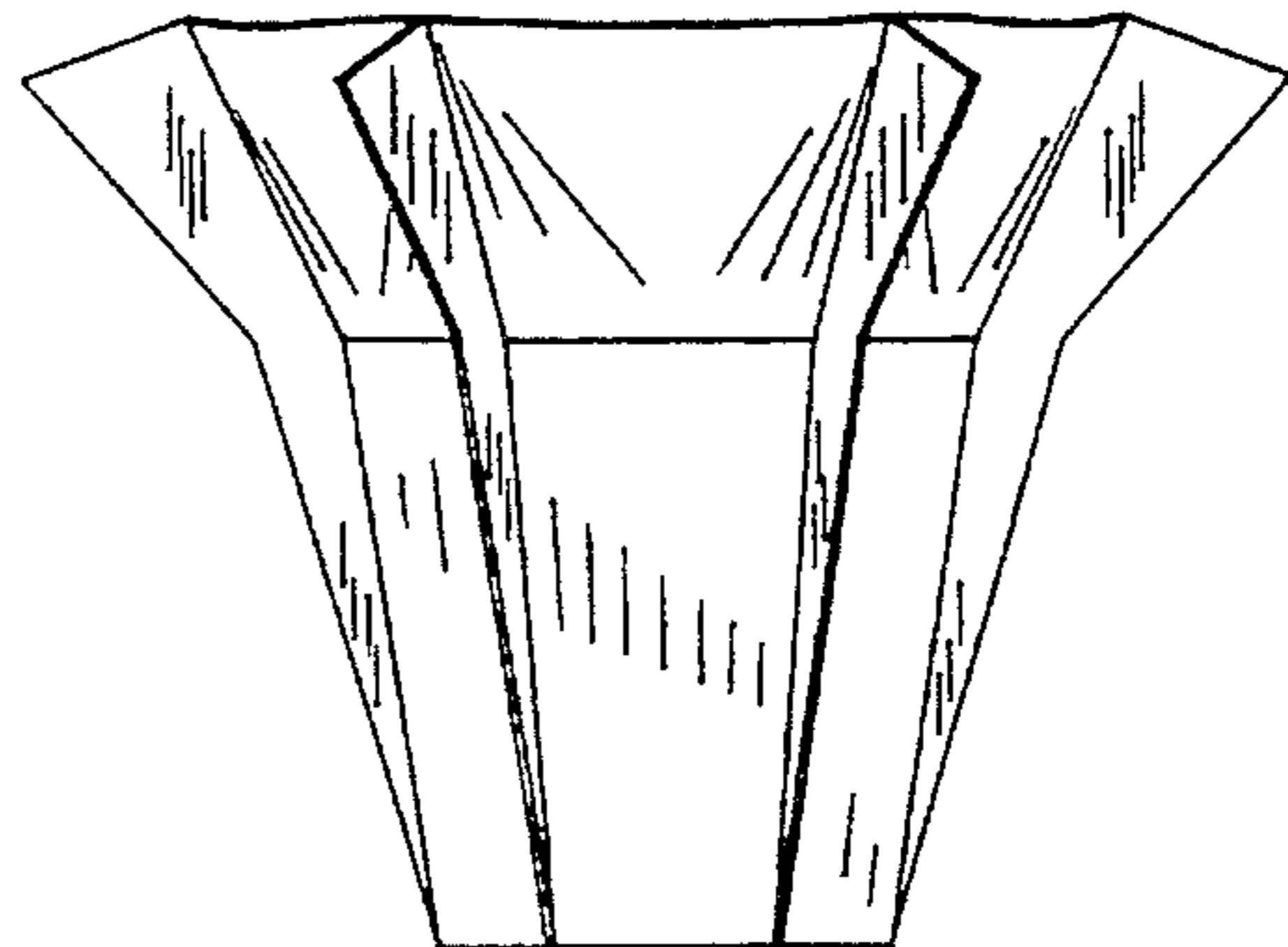

FIG. 6

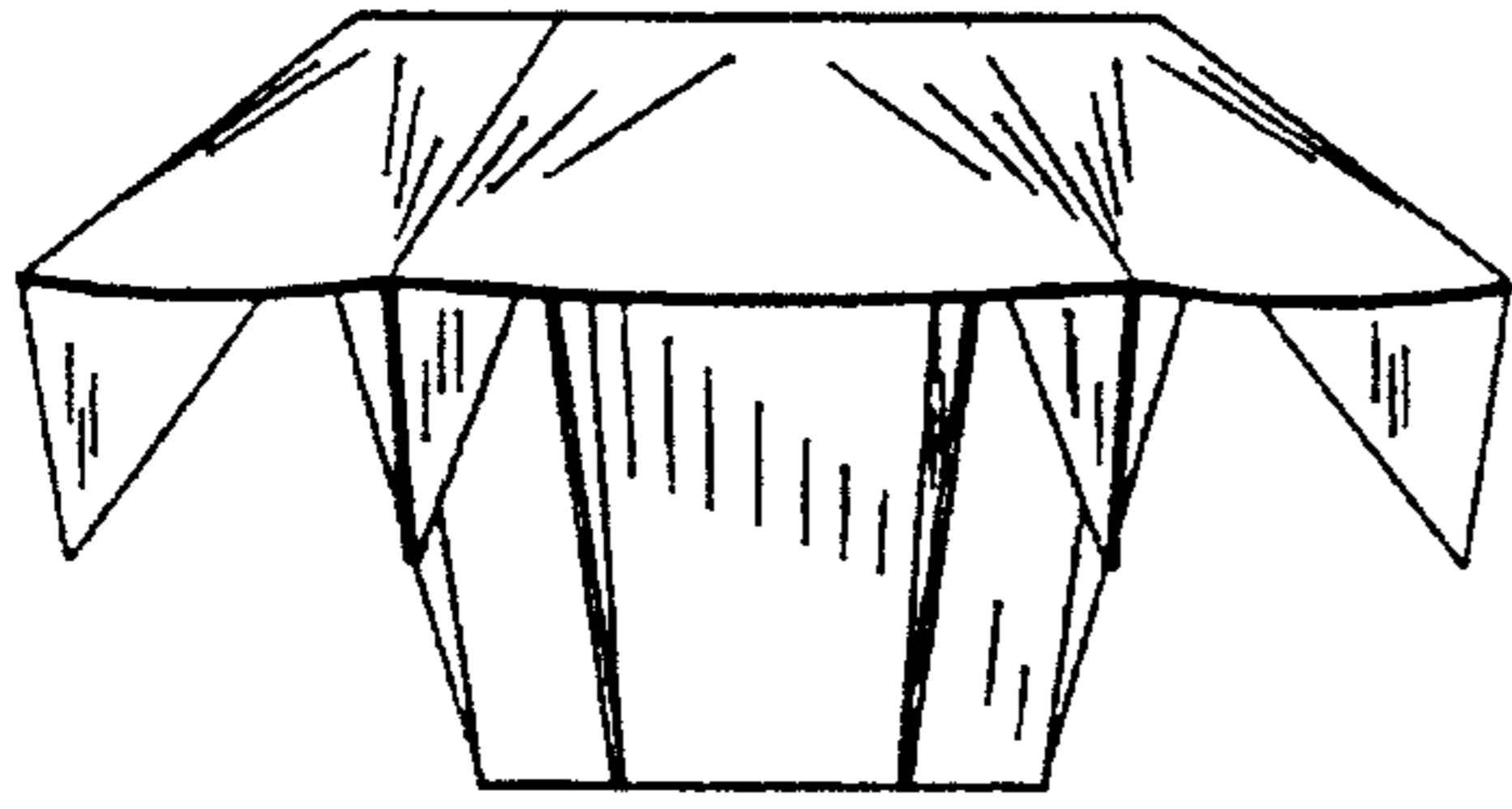

FIG. 7

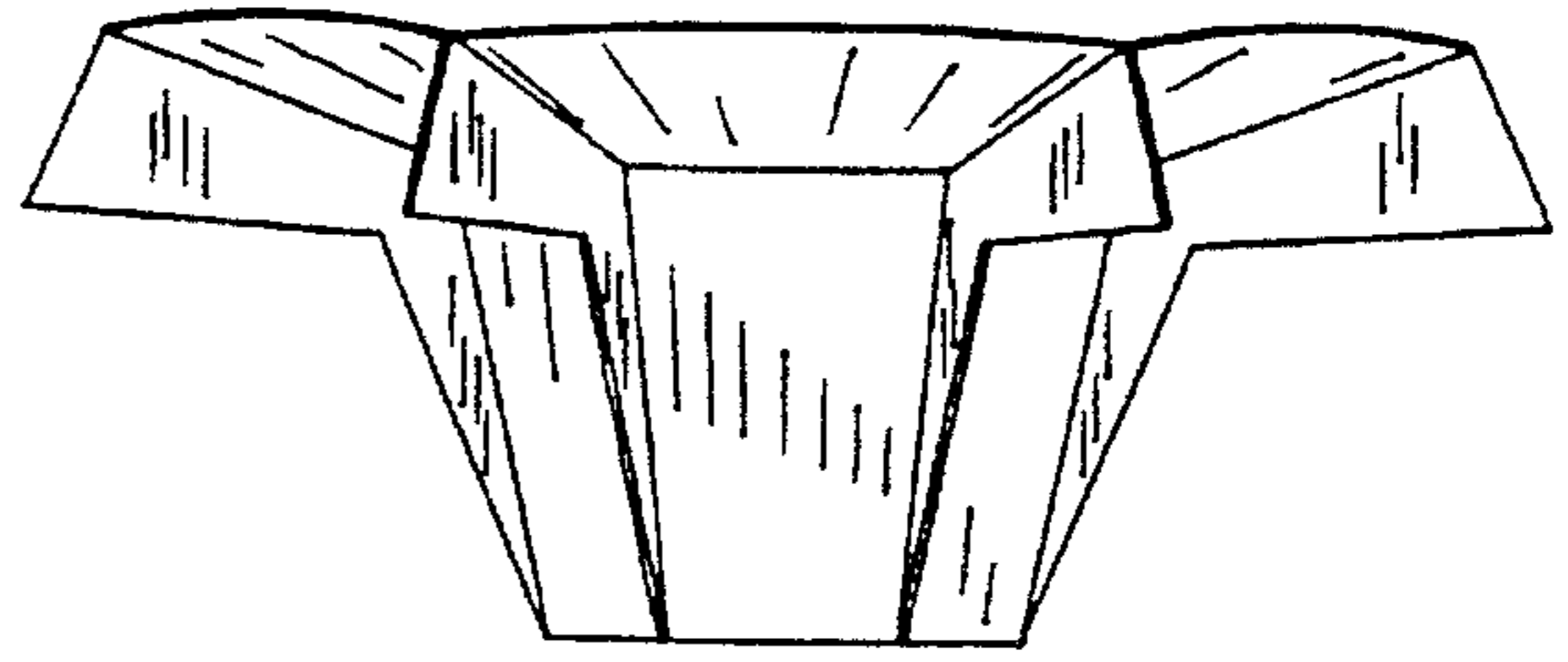

FIG. 8

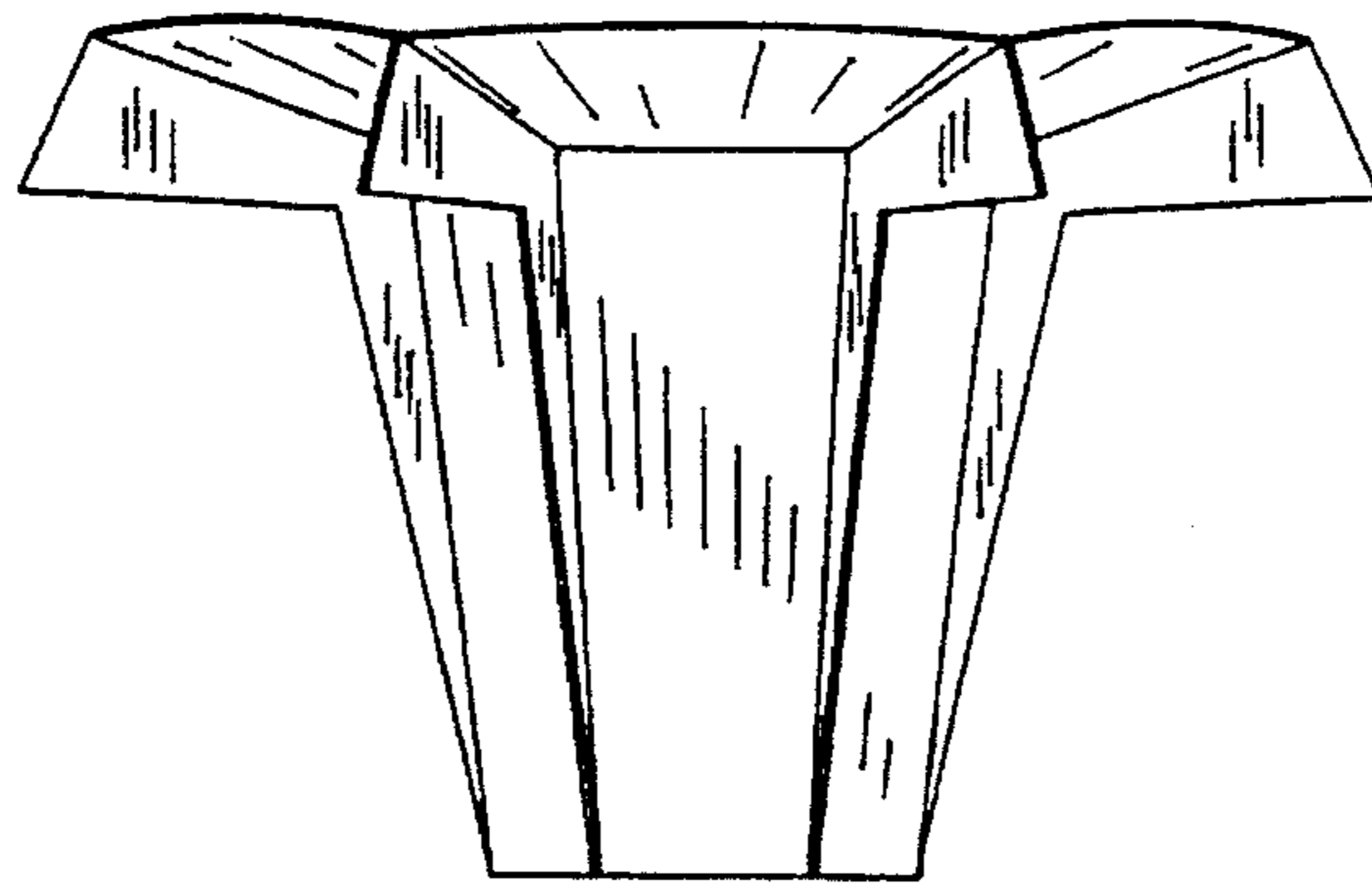

FIG. 9

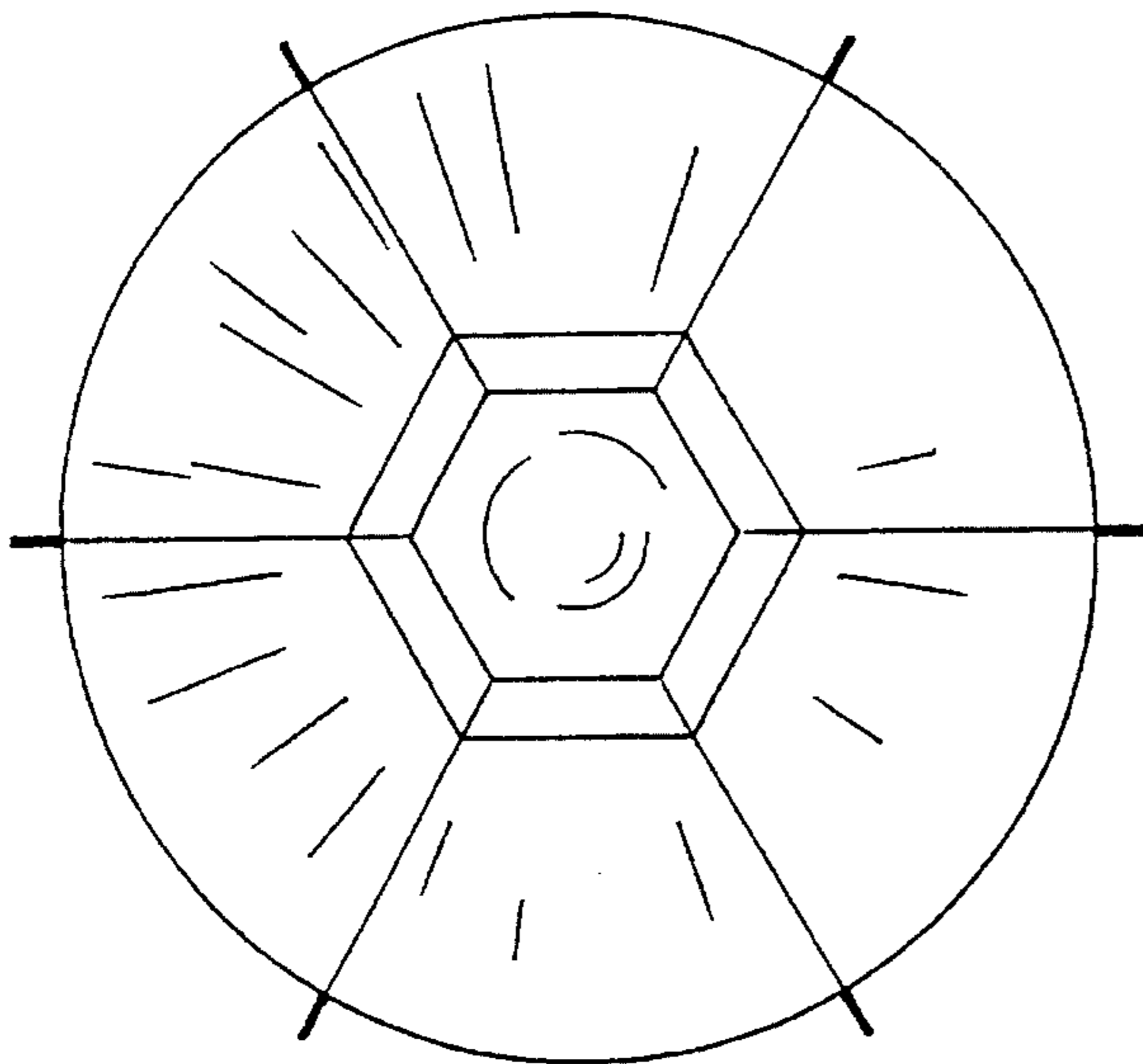

FIG. 10

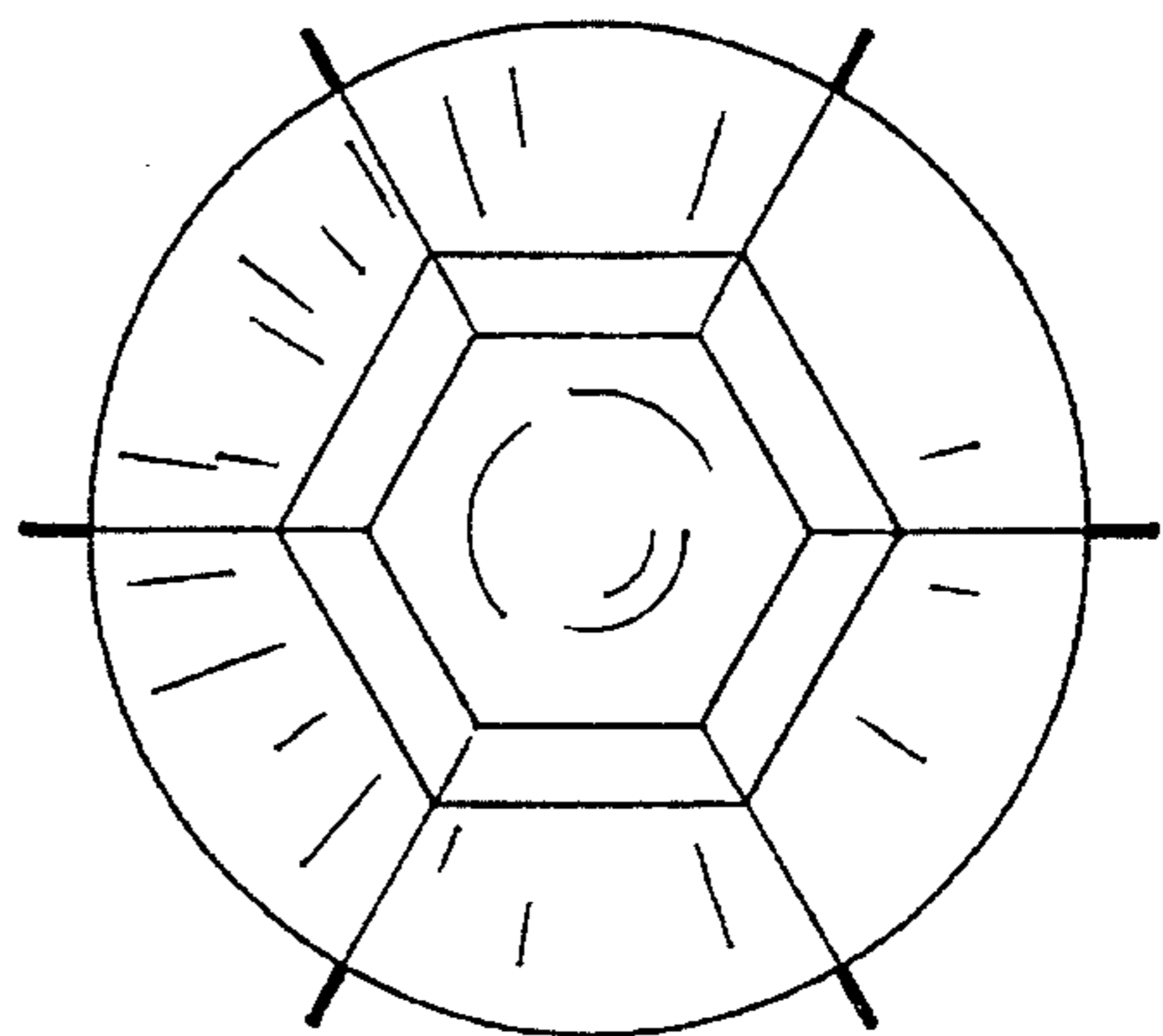

FIG. 11

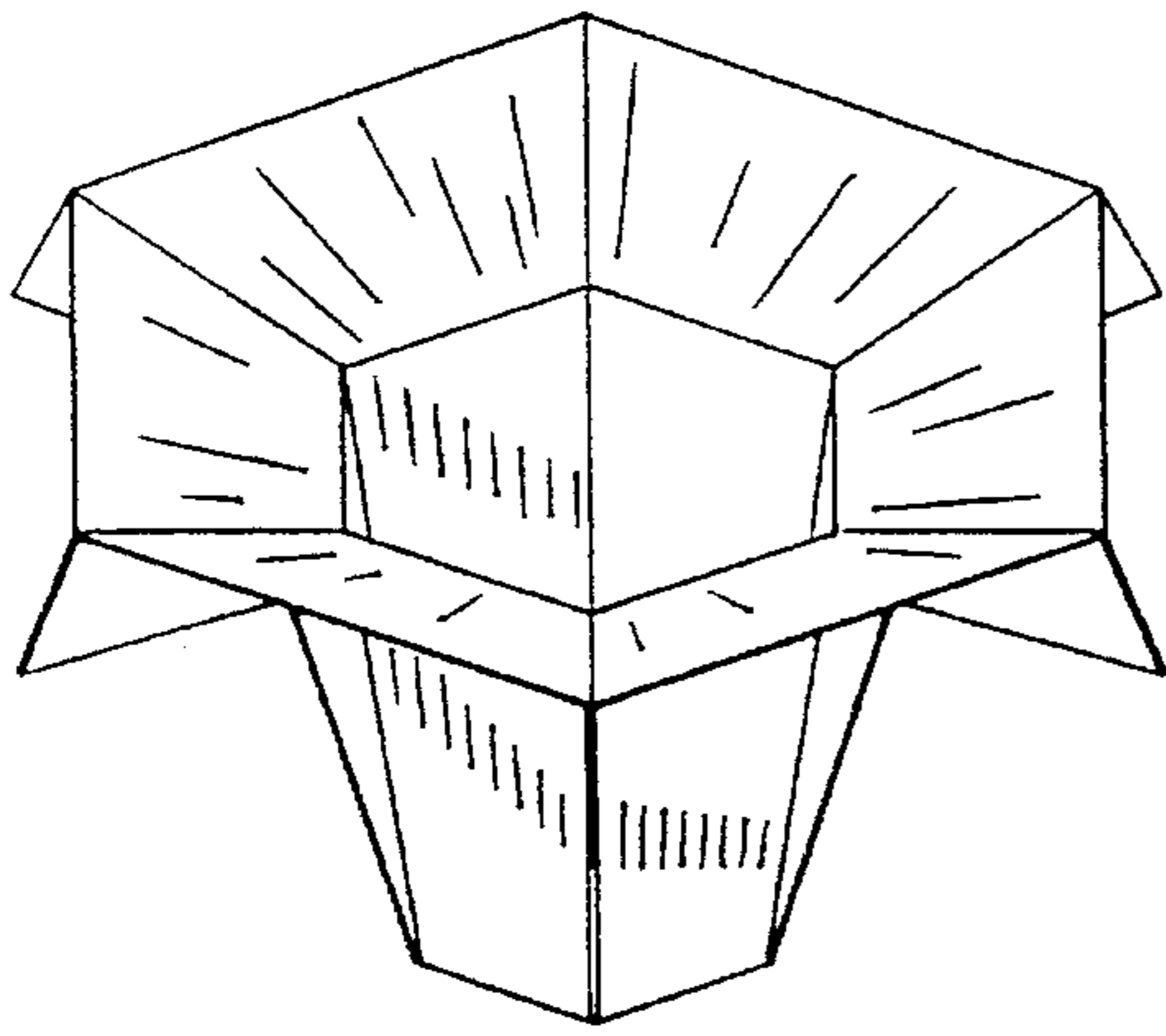

FIG. 12

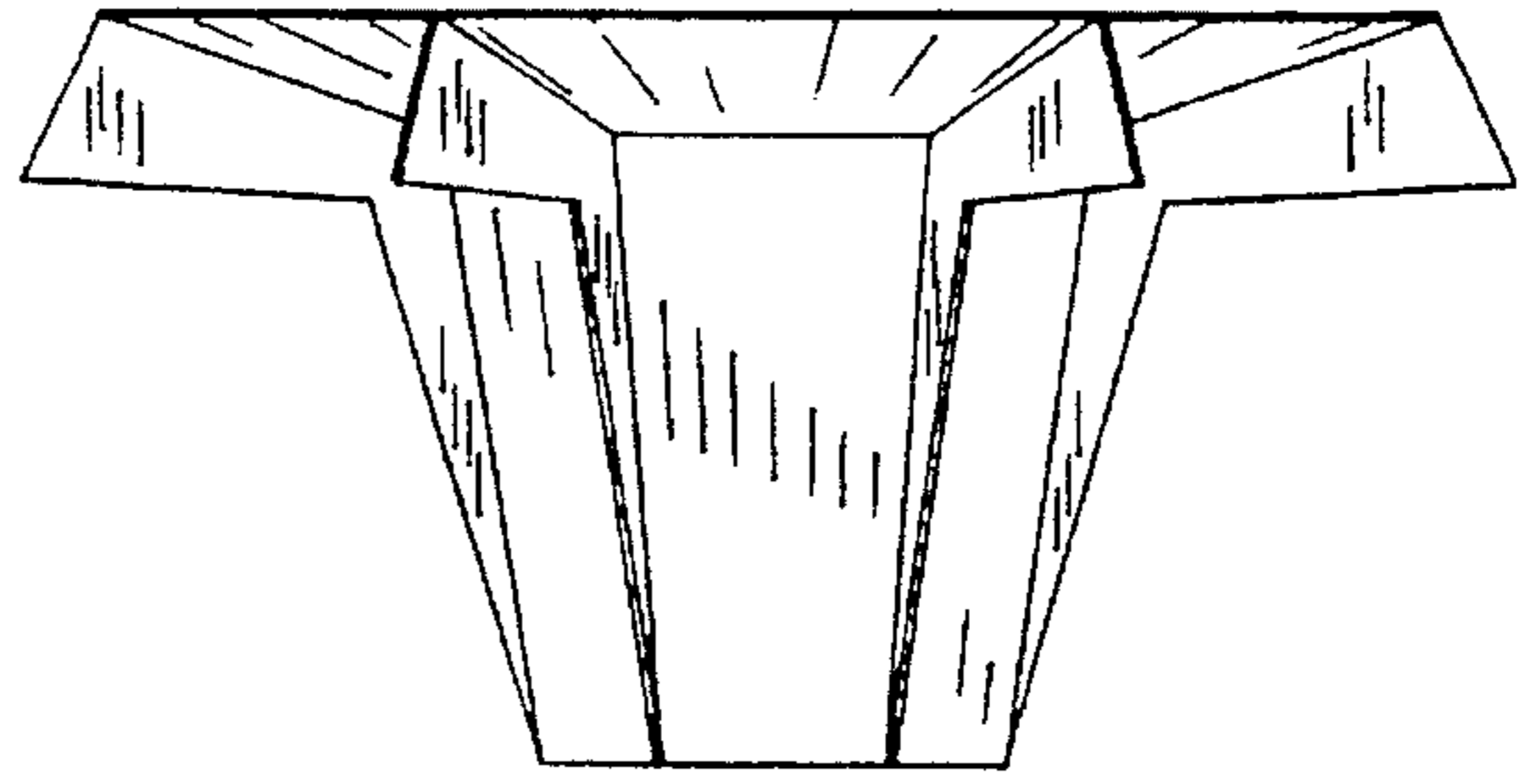

FIG. 13

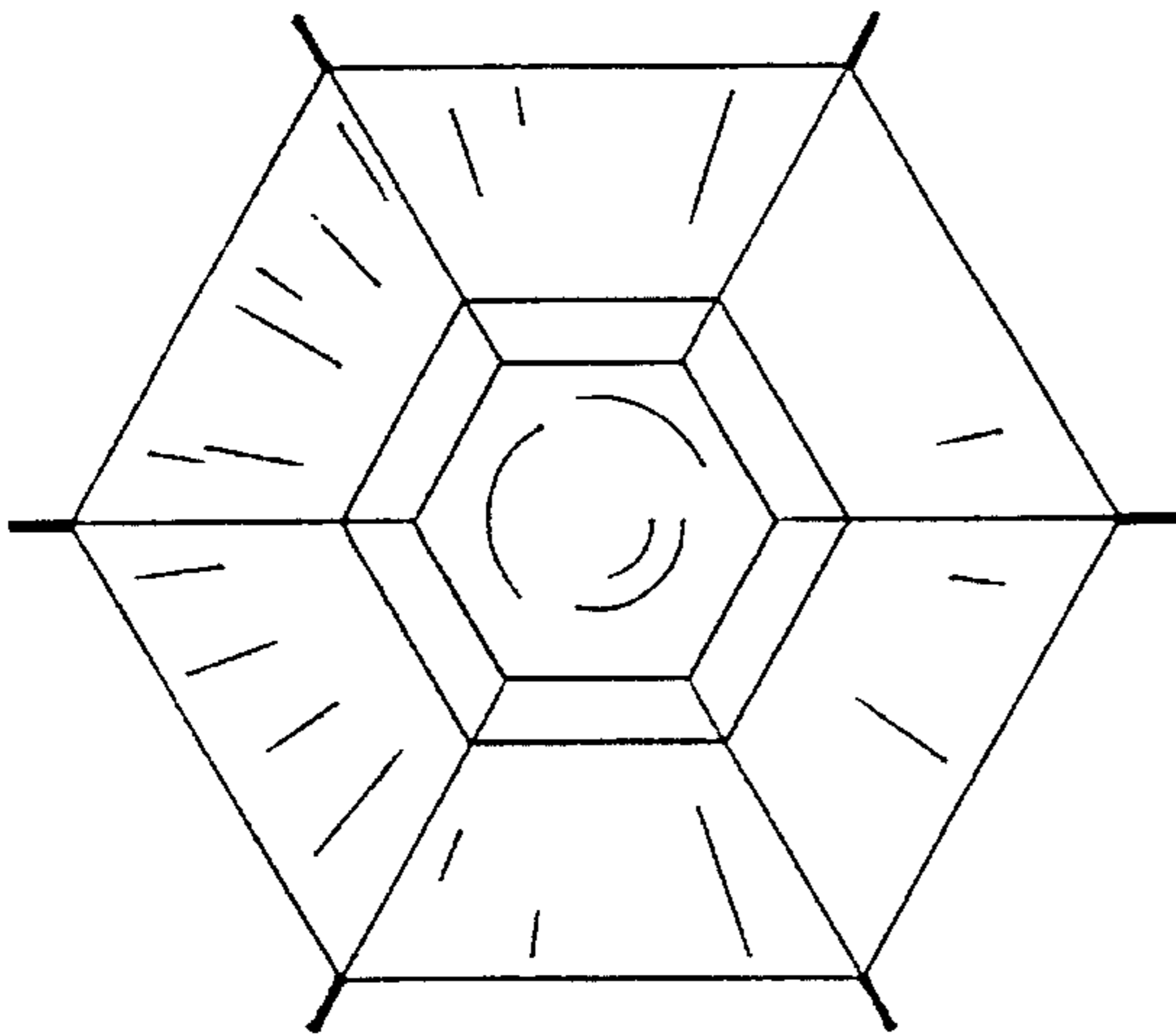

FIG. 14

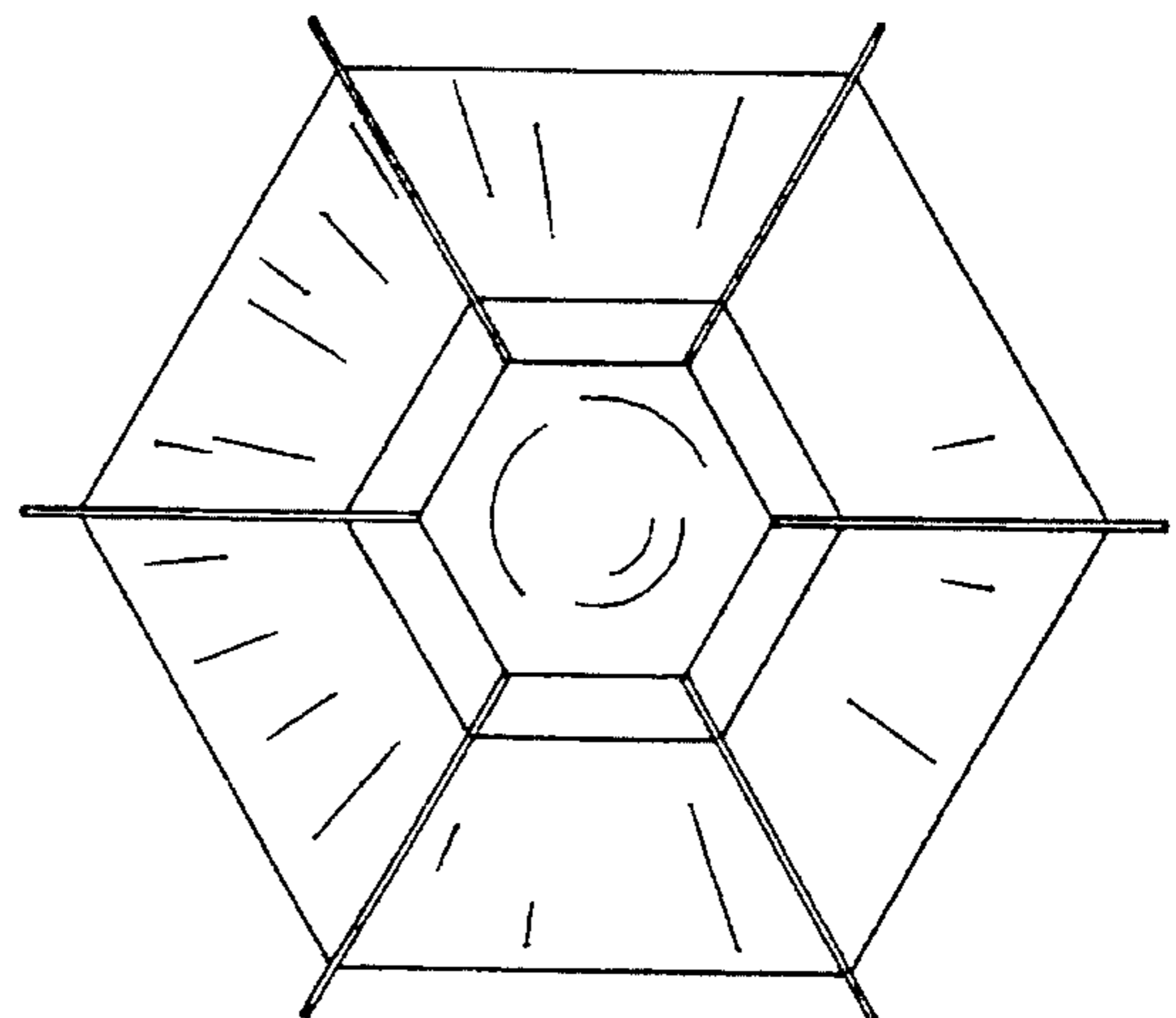

FIG. 15

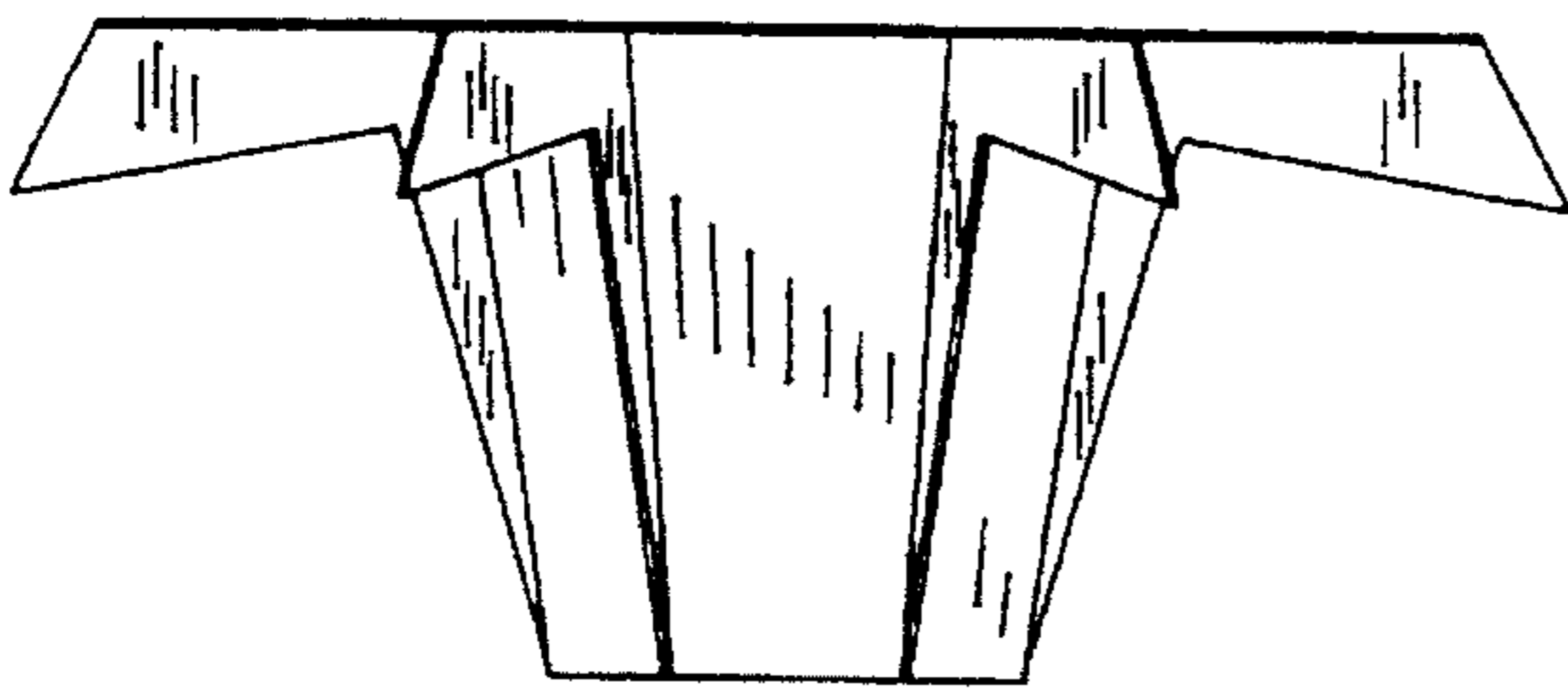

FIG. 16

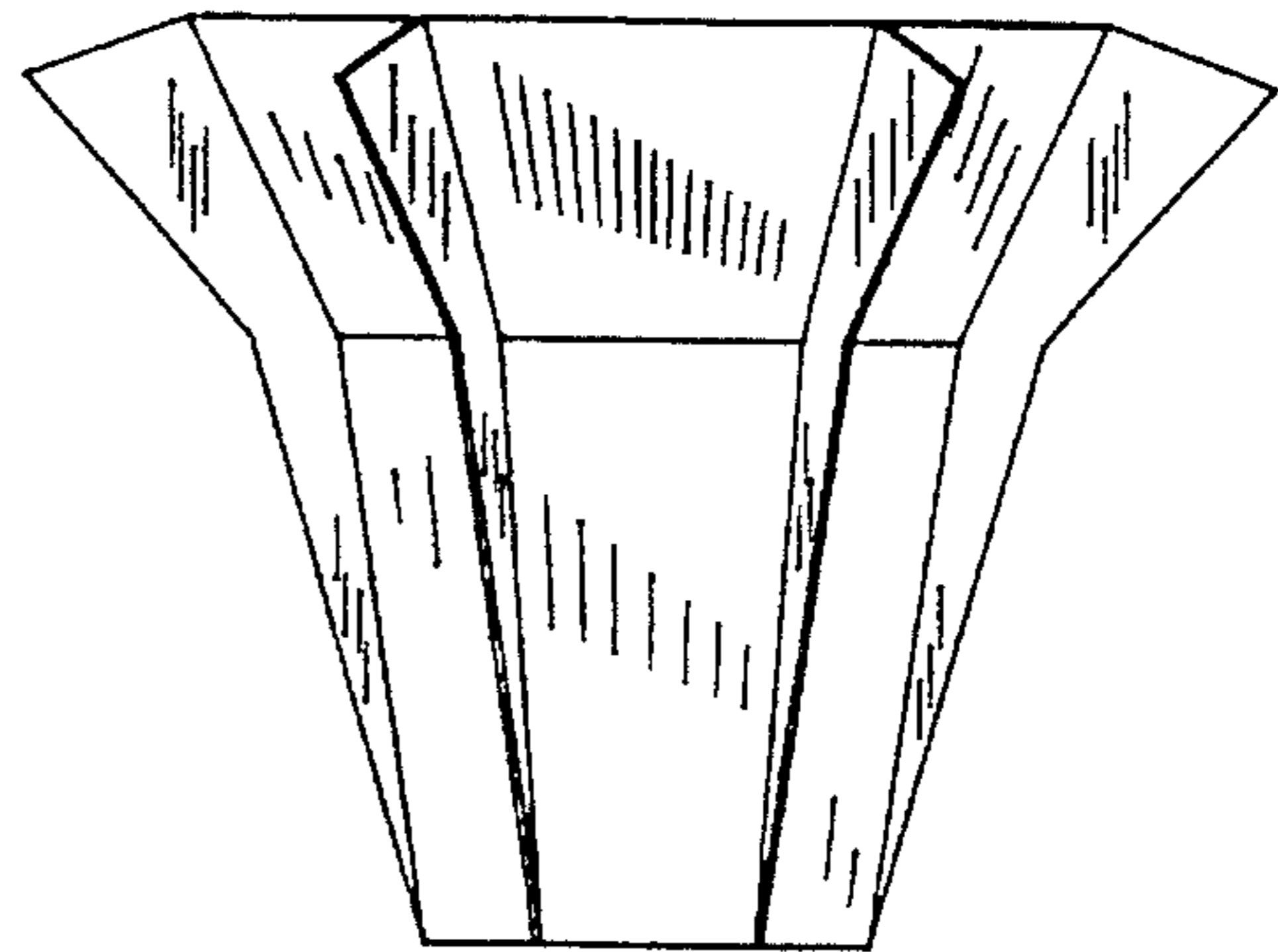

FIG. 17

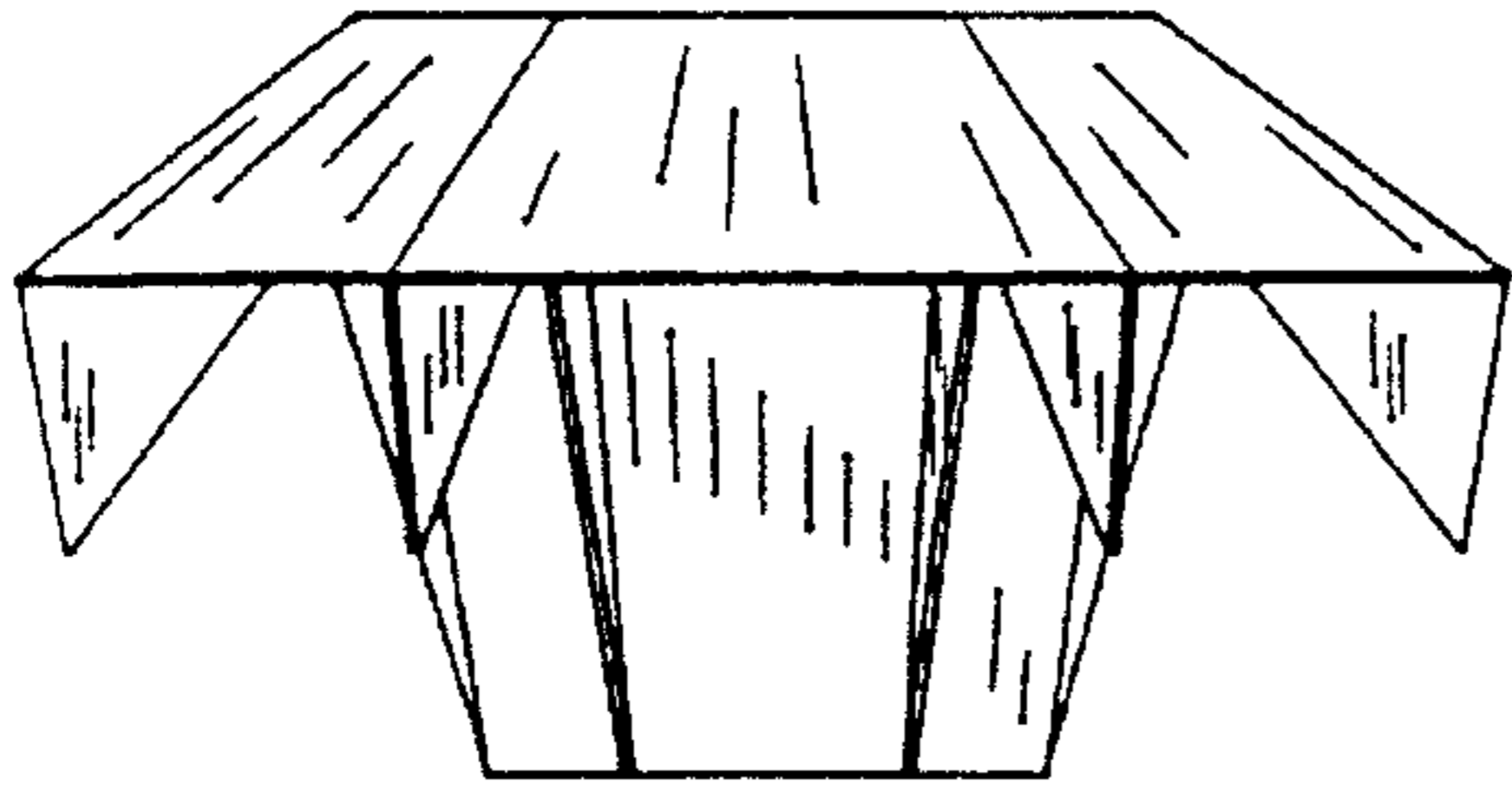

FIG. 18

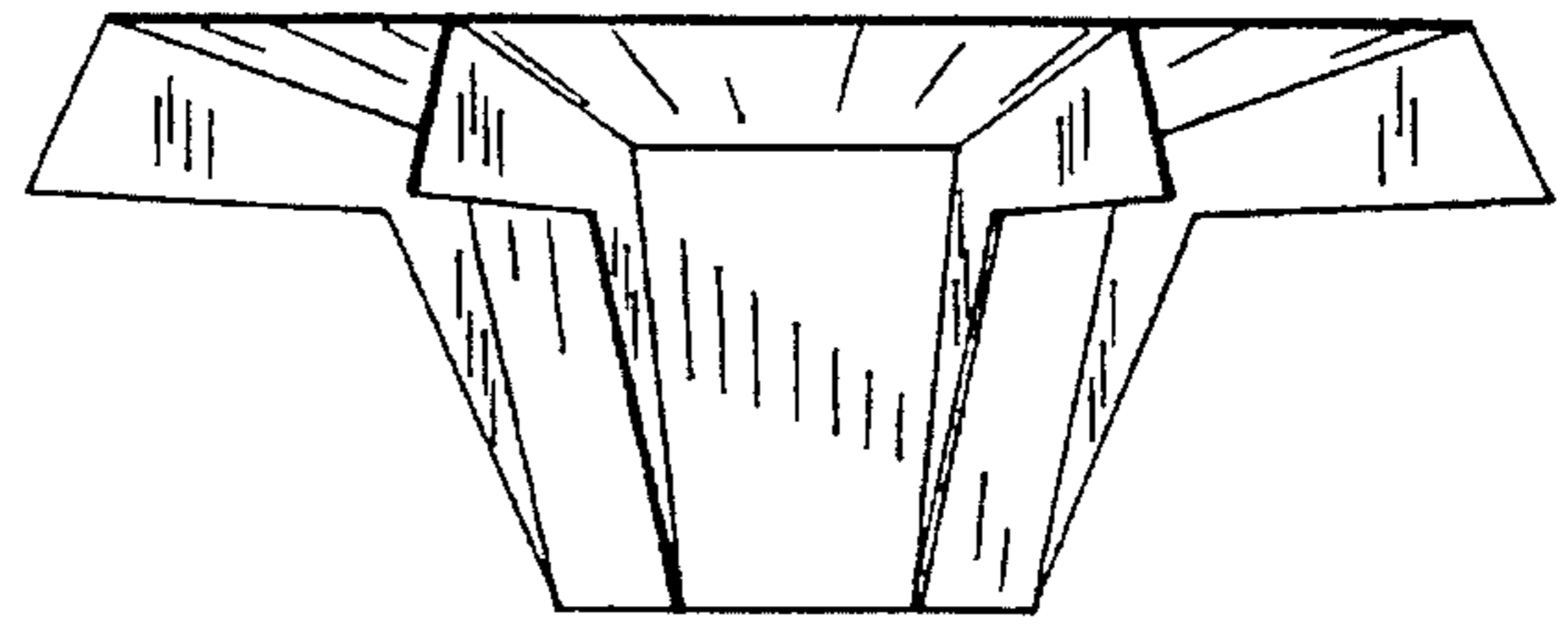

FIG. 19

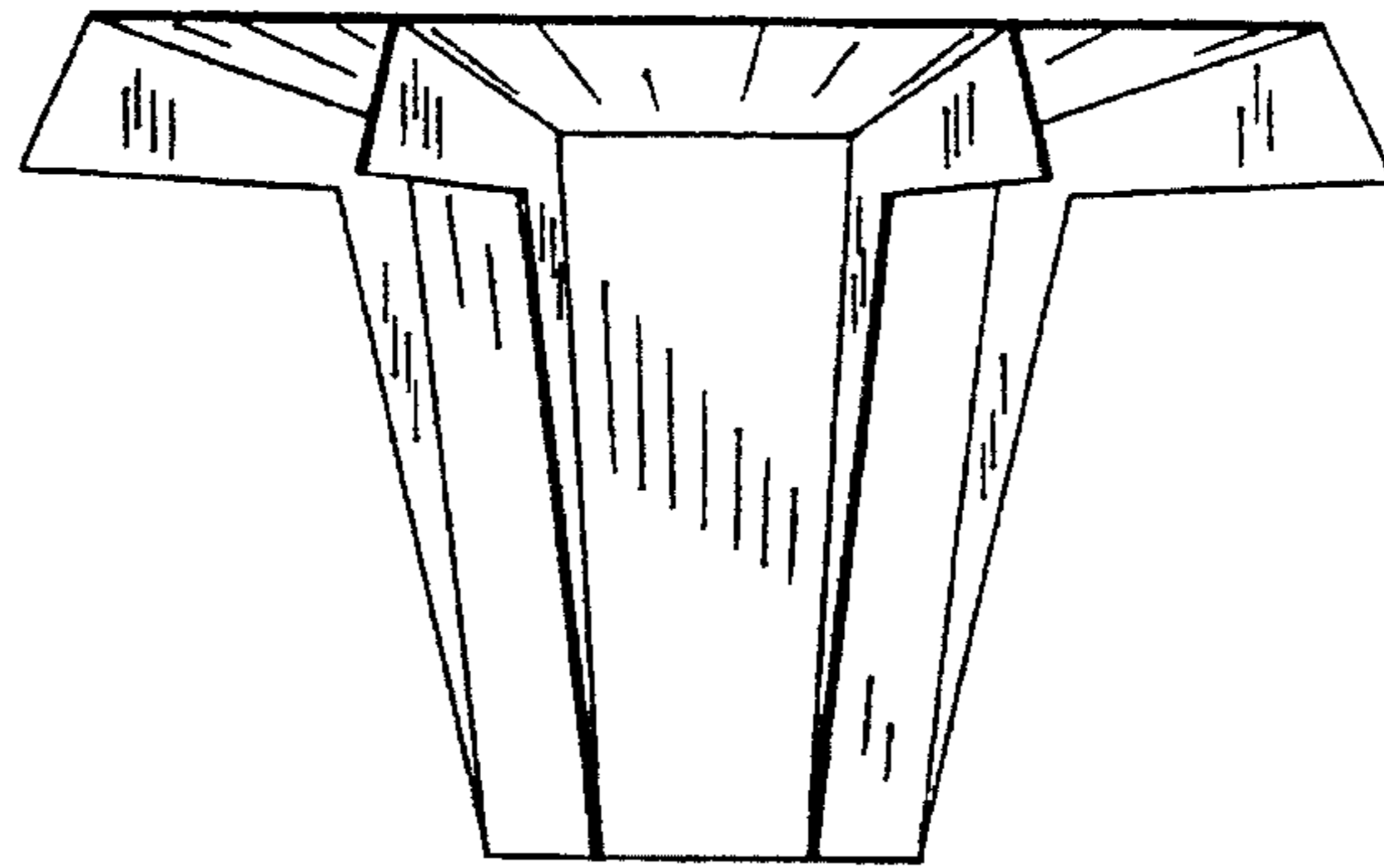

FIG. 20

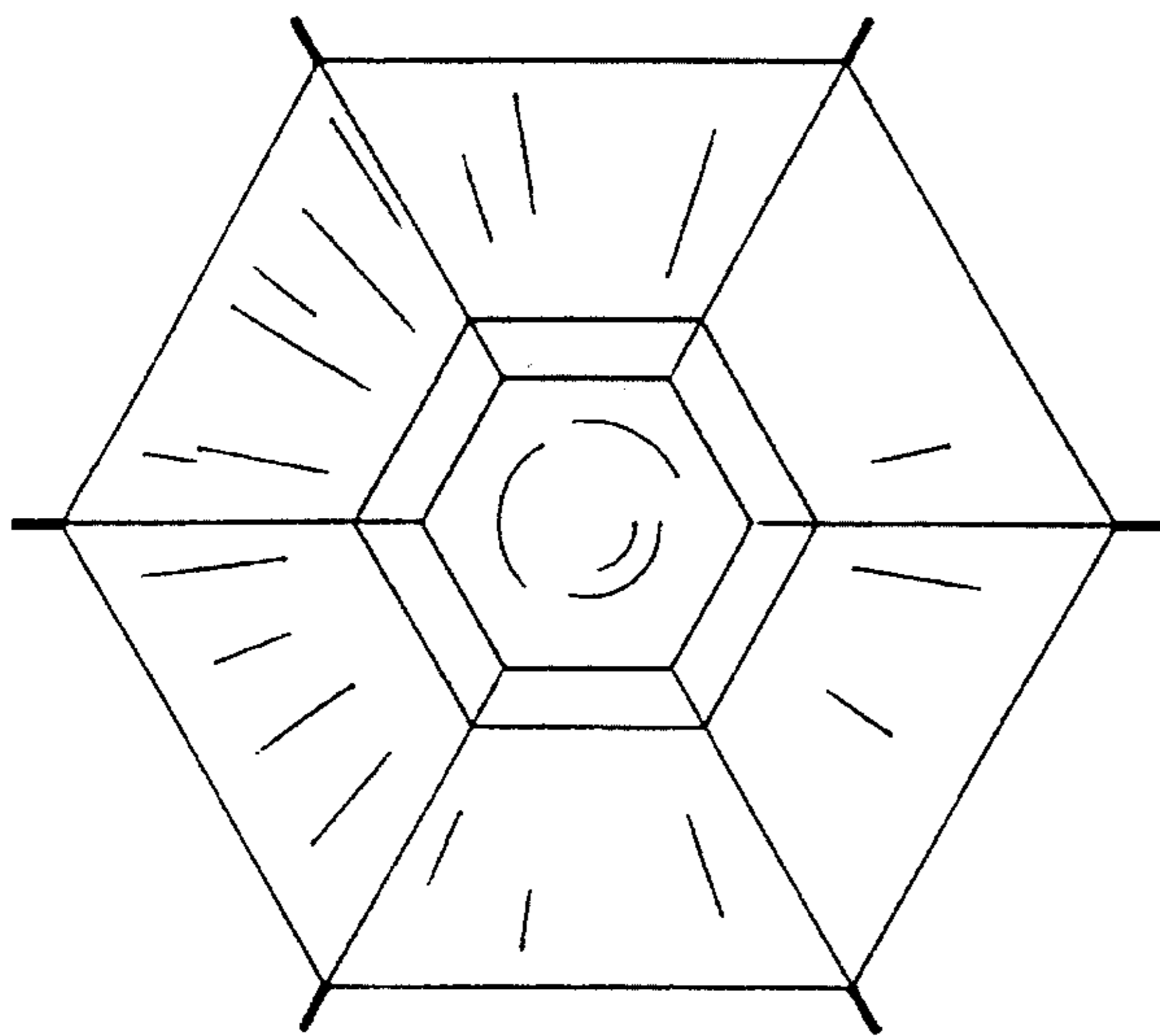

FIG. 21

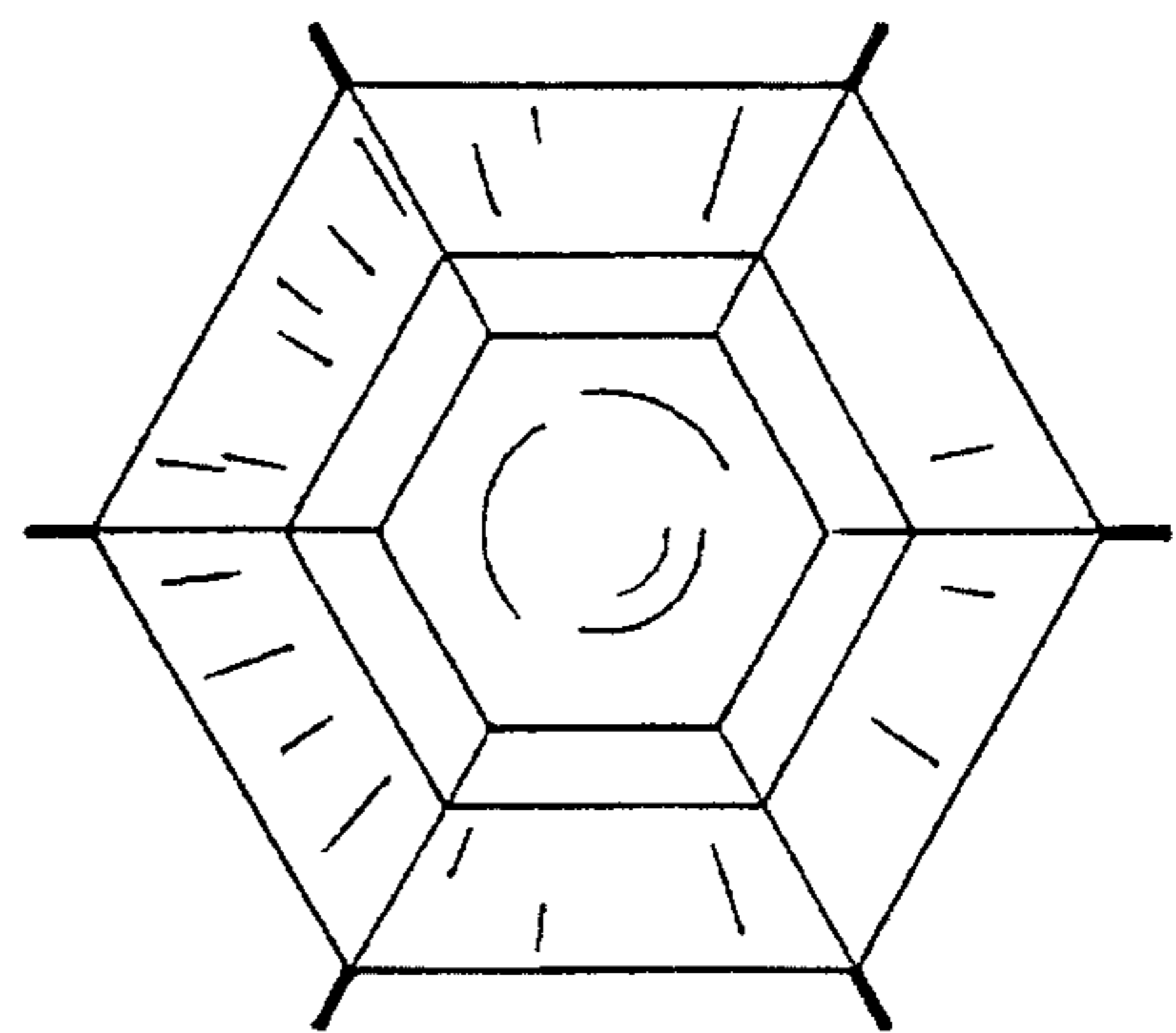

FIG. 22

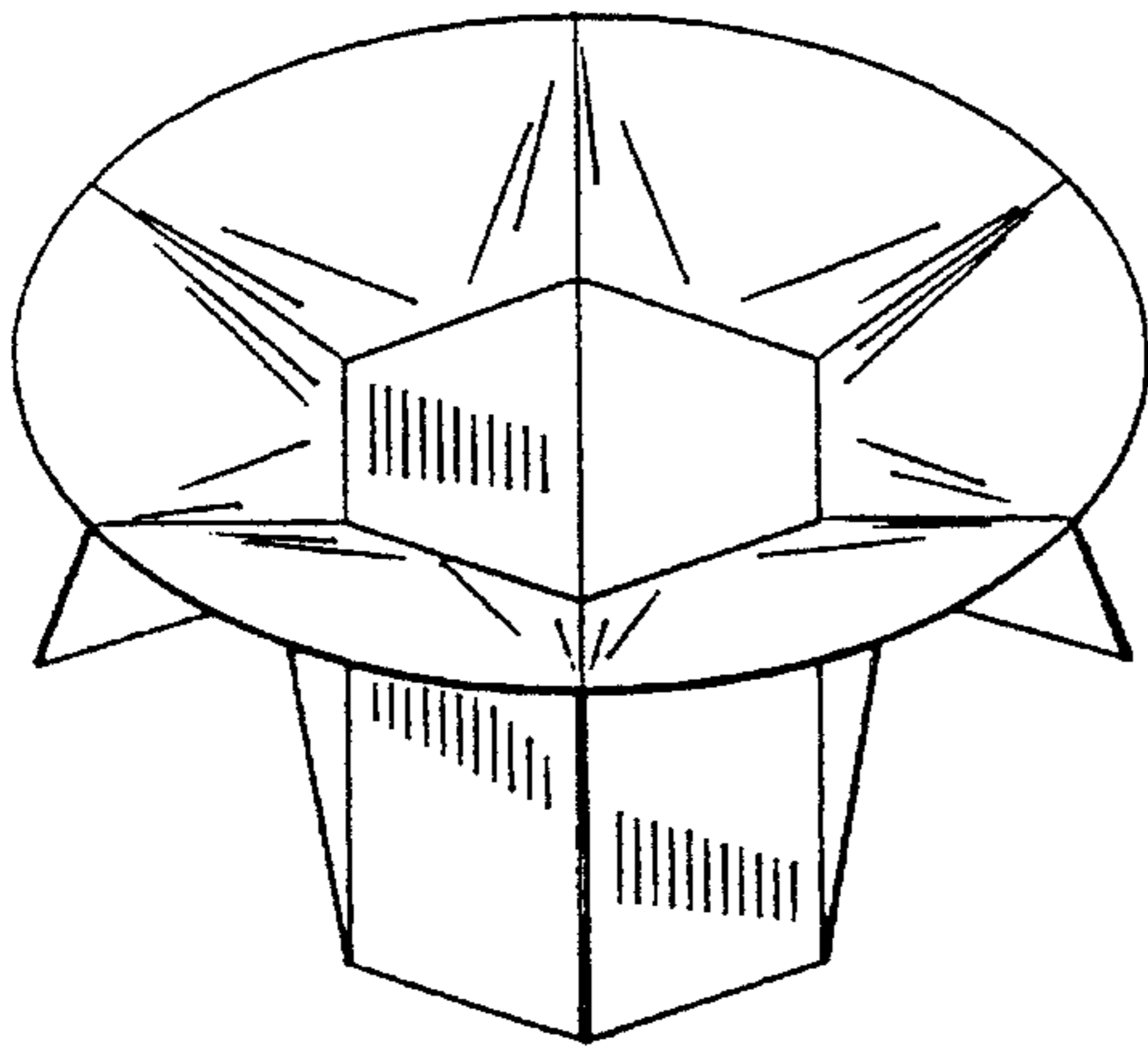

FIG. 23

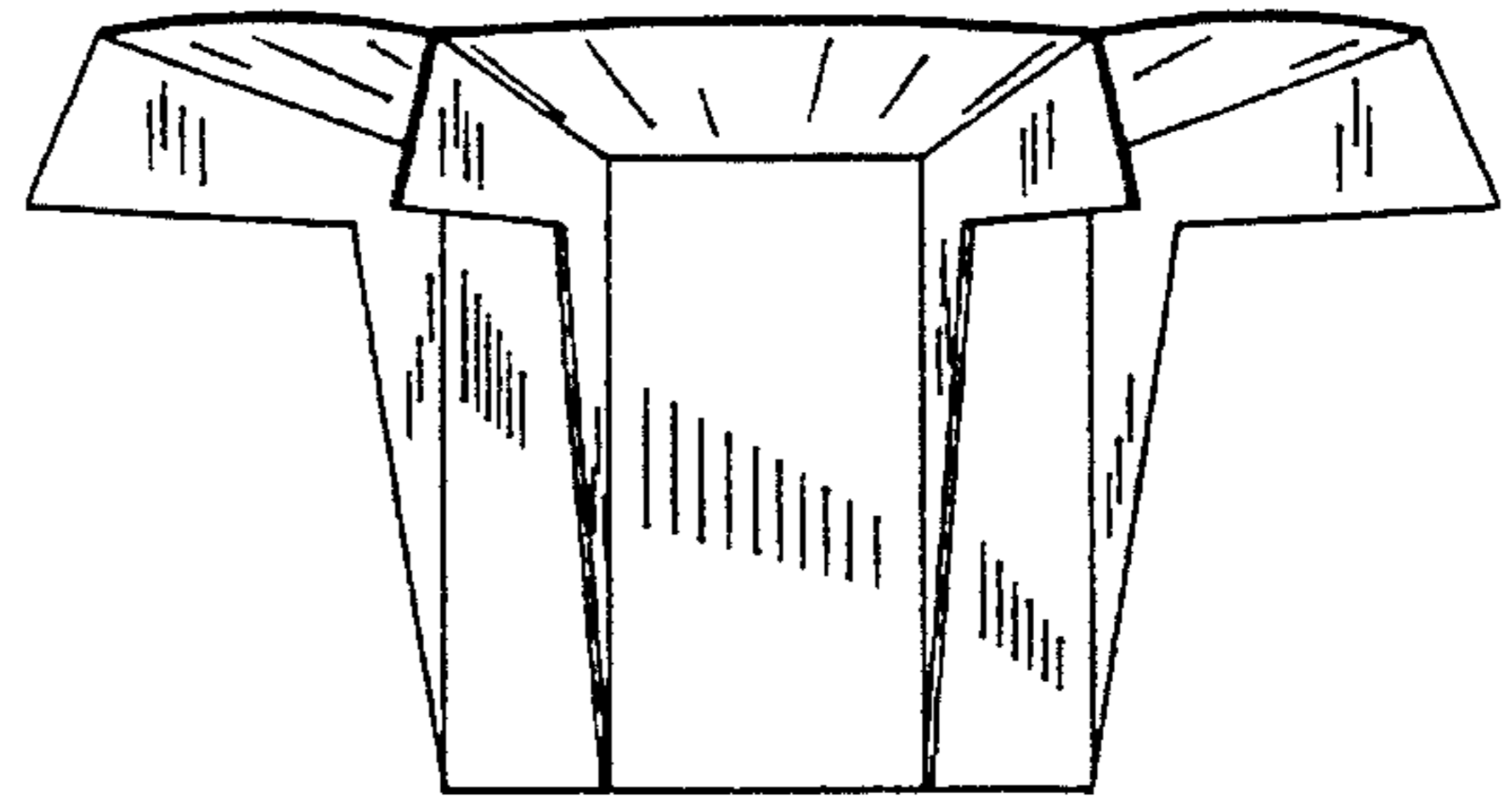

FIG. 24

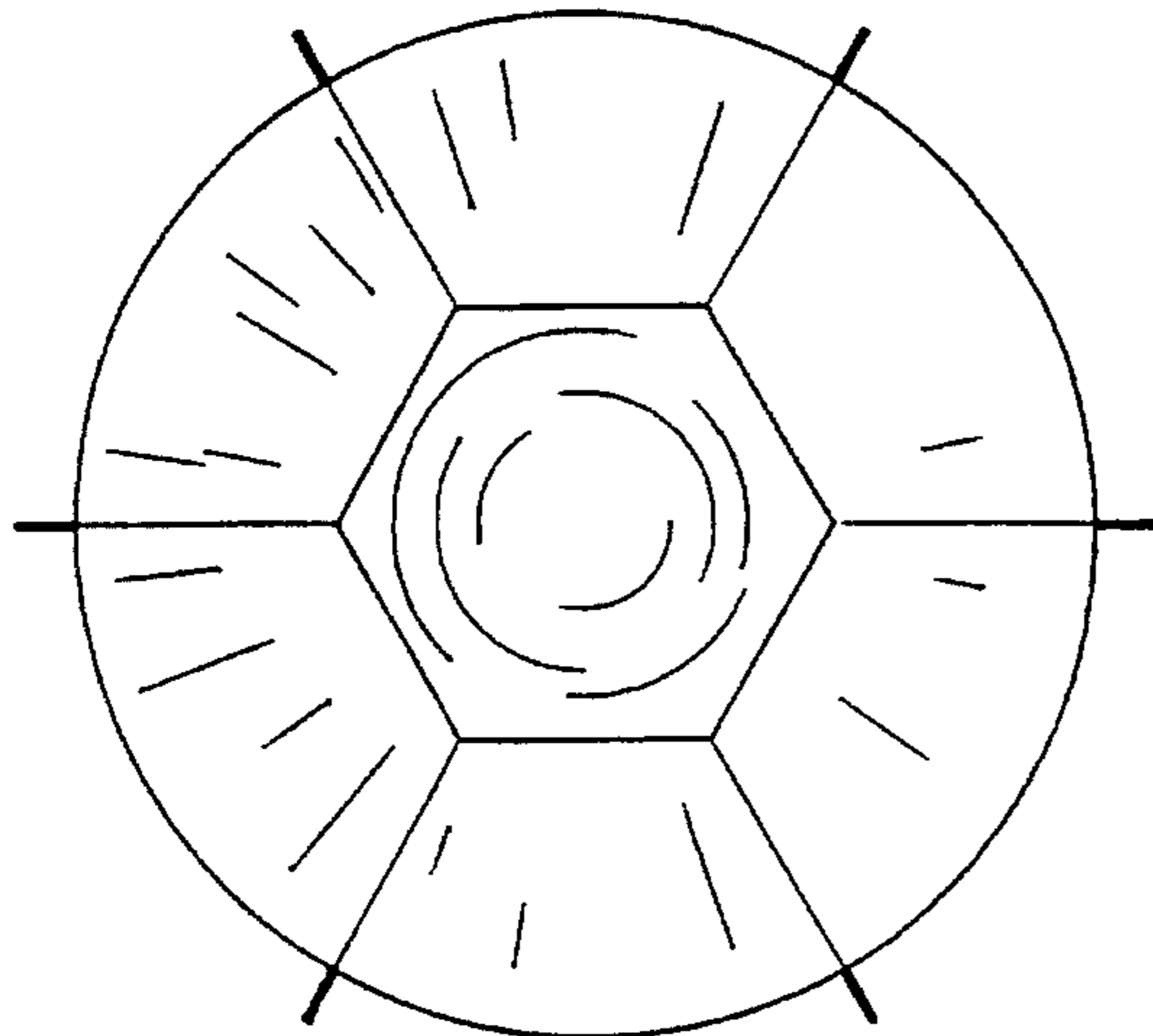

FIG. 25

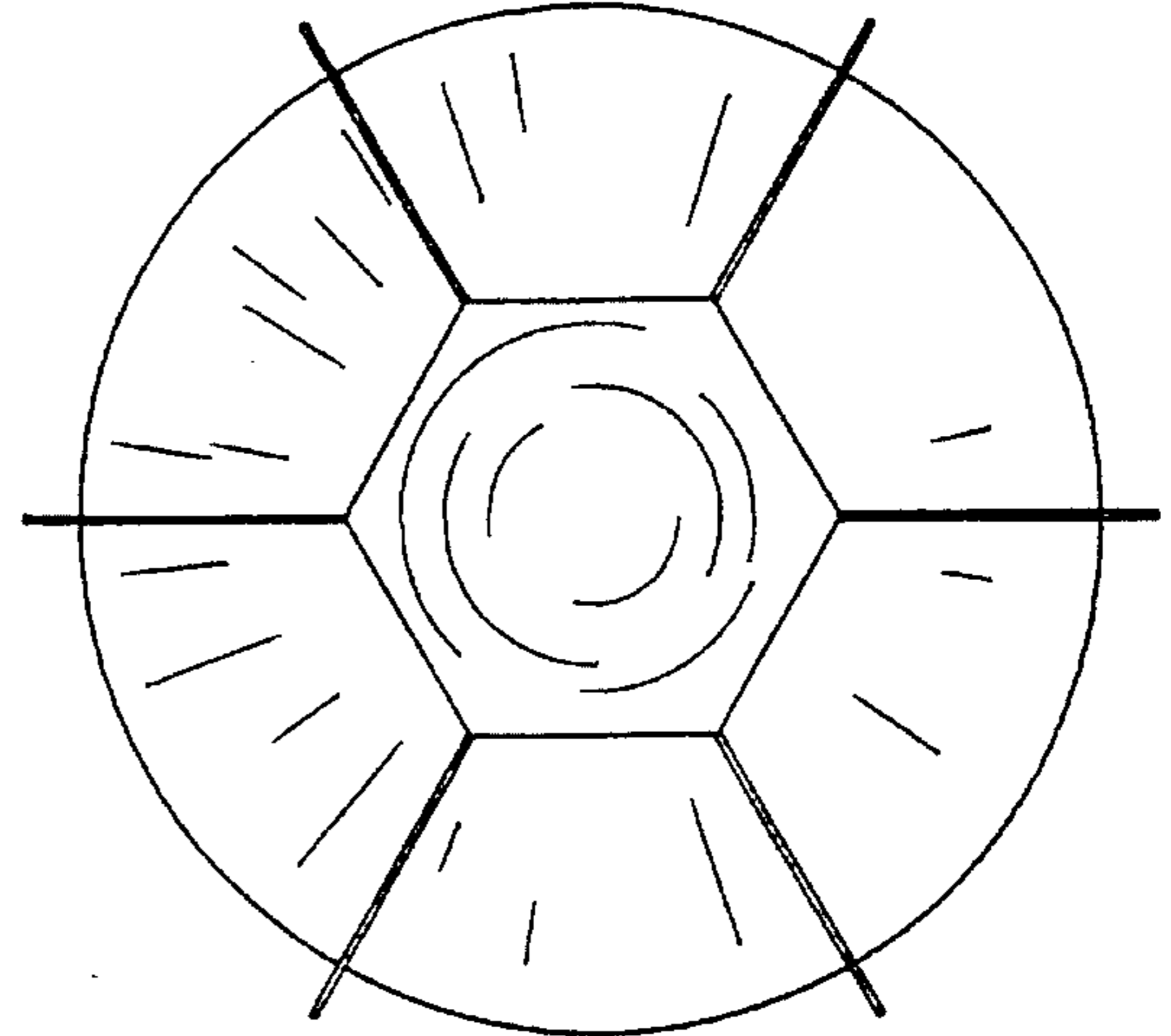

FIG. 26

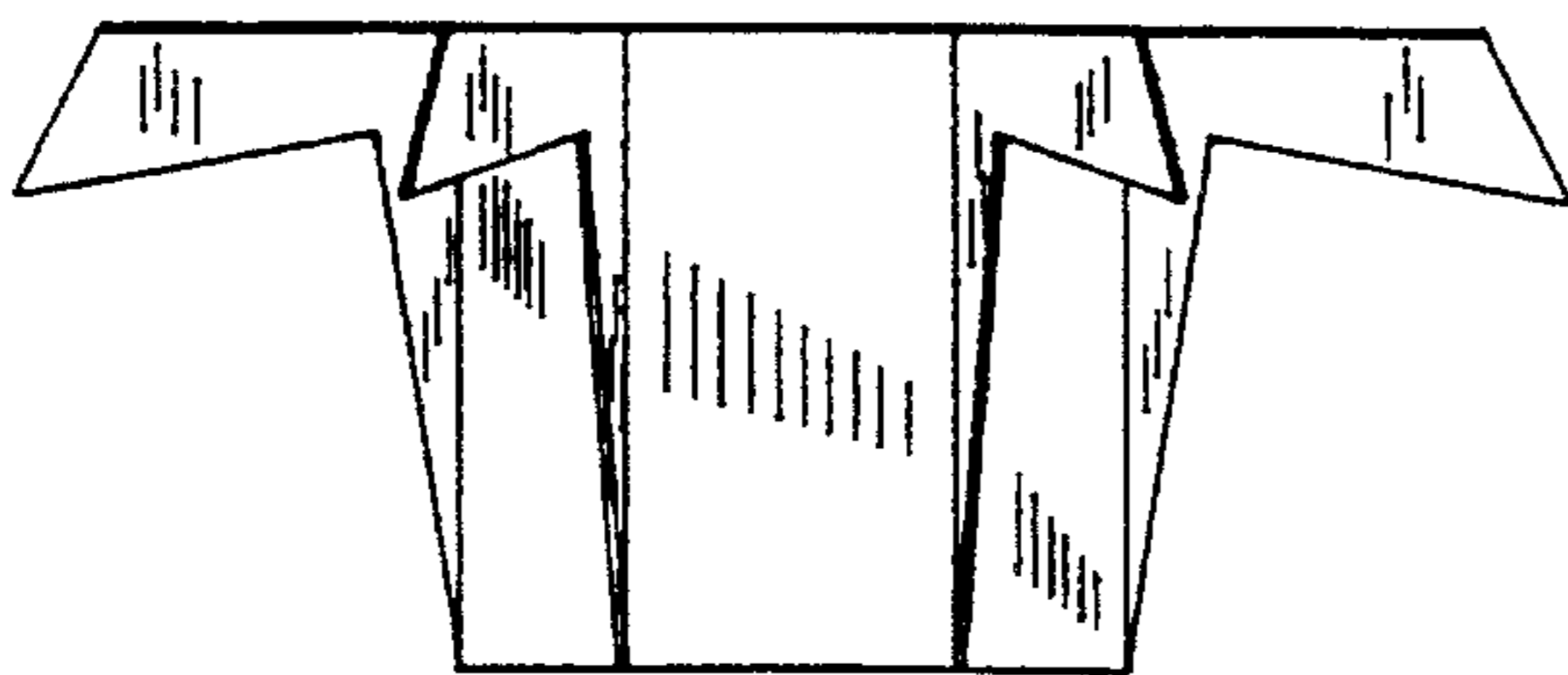

FIG. 27

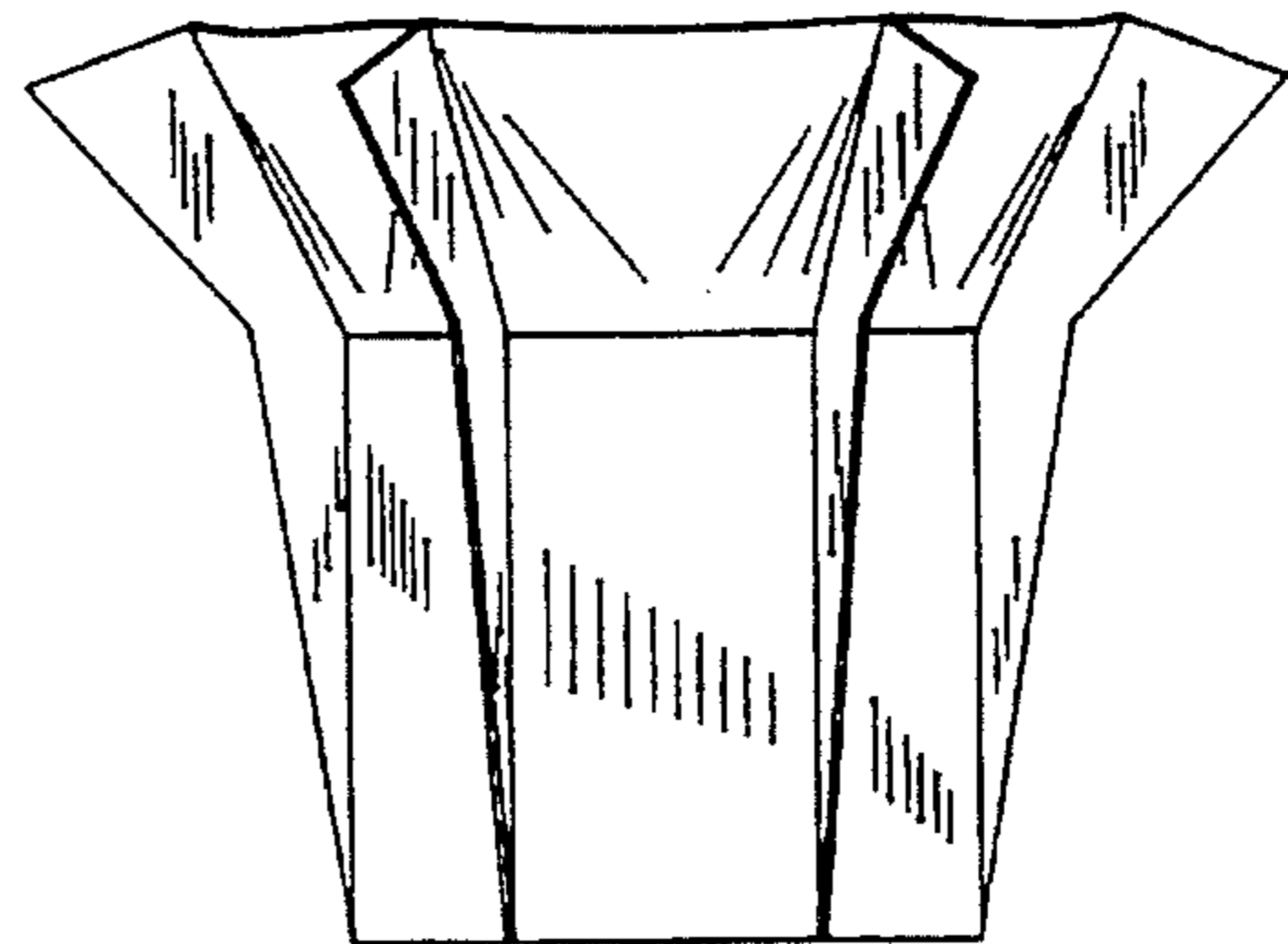

FIG. 28

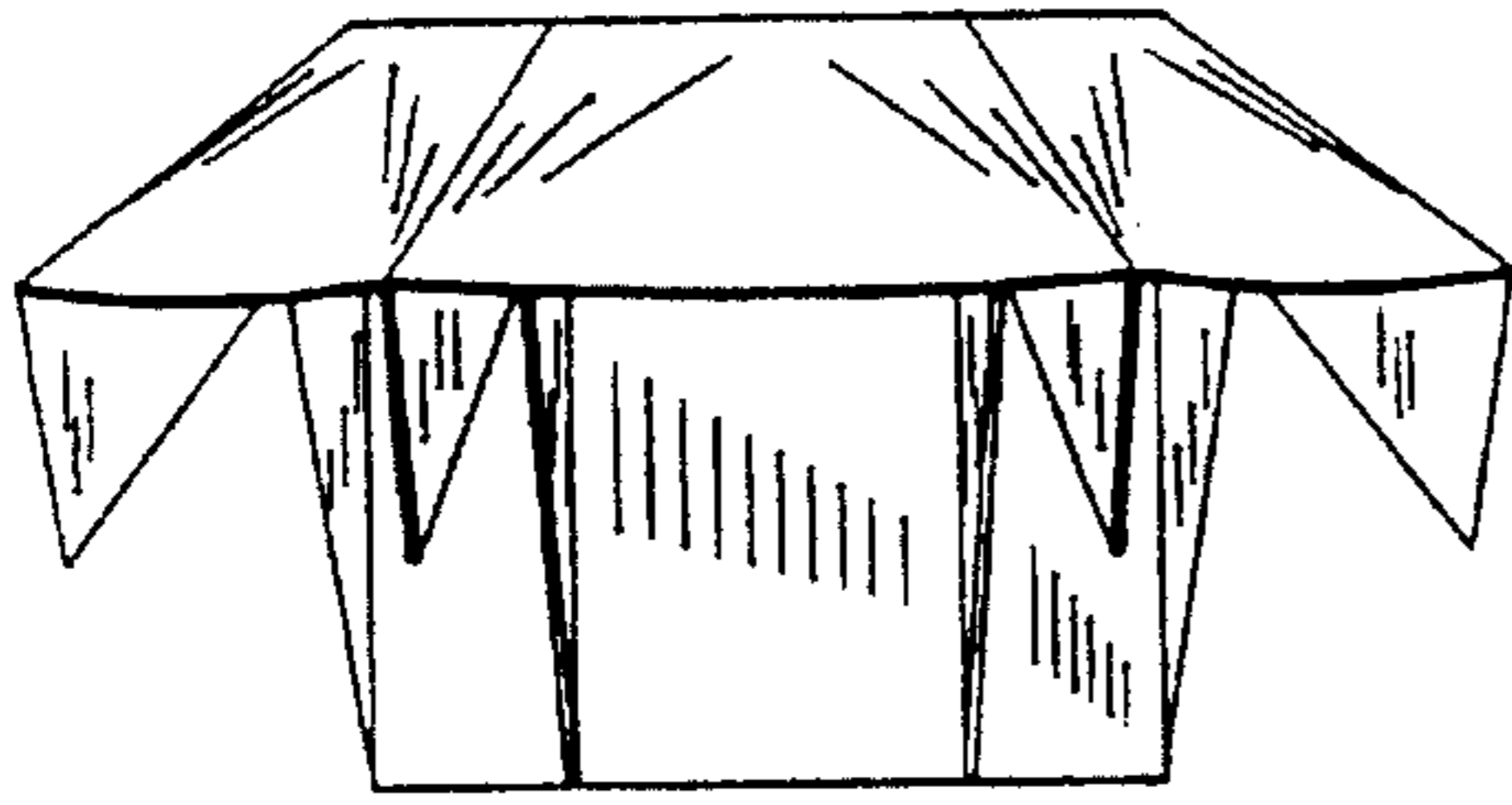

FIG. 29

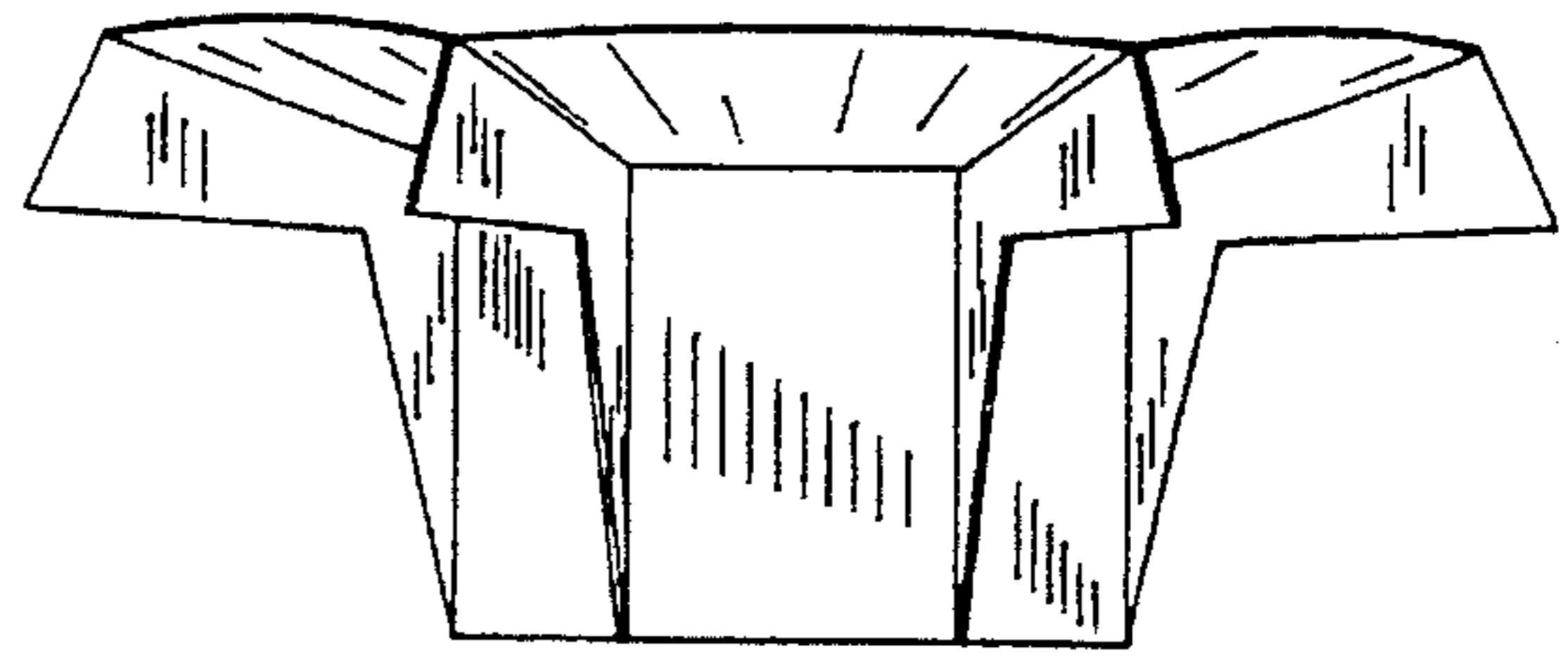

FIG. 30

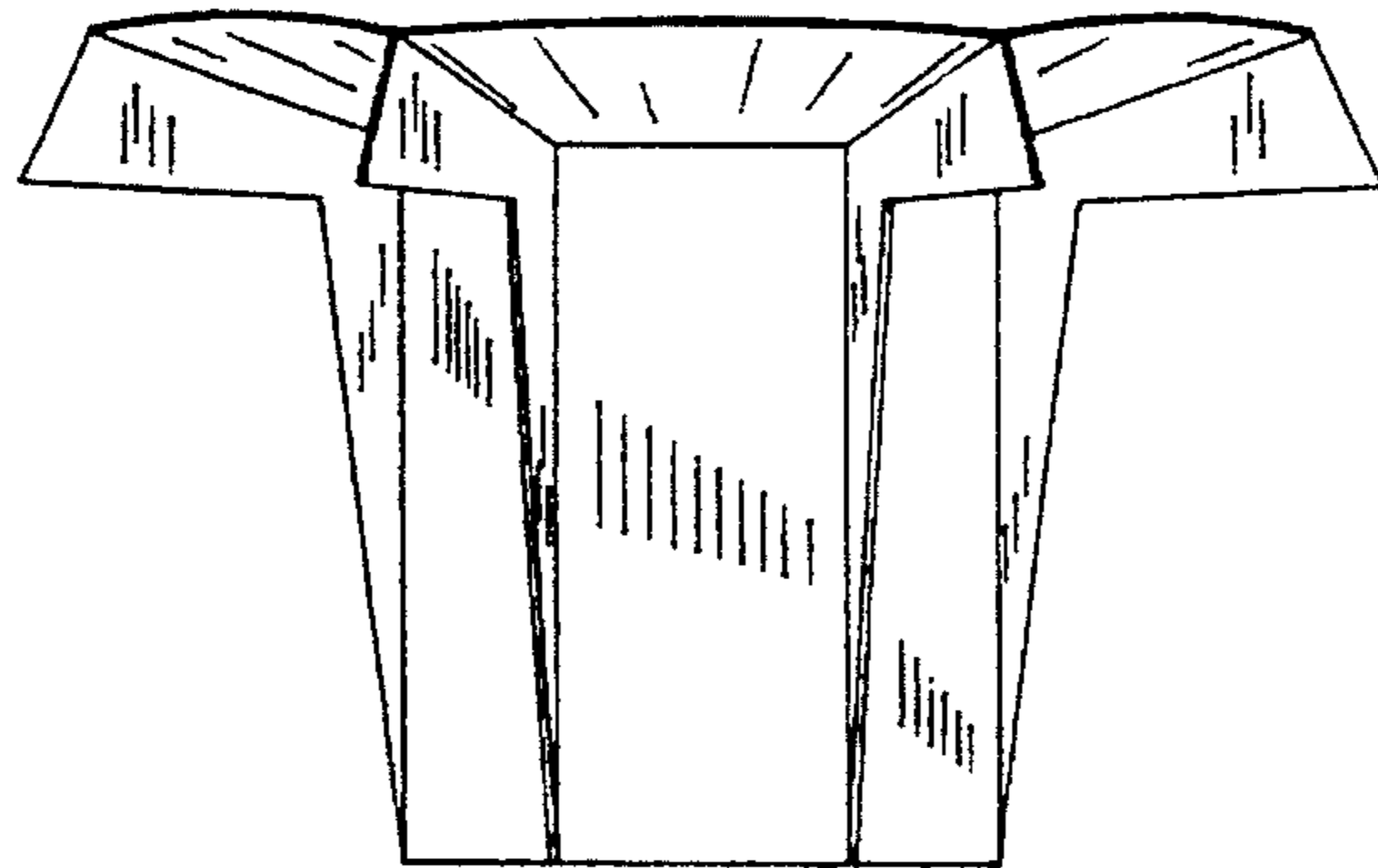

FIG. 31

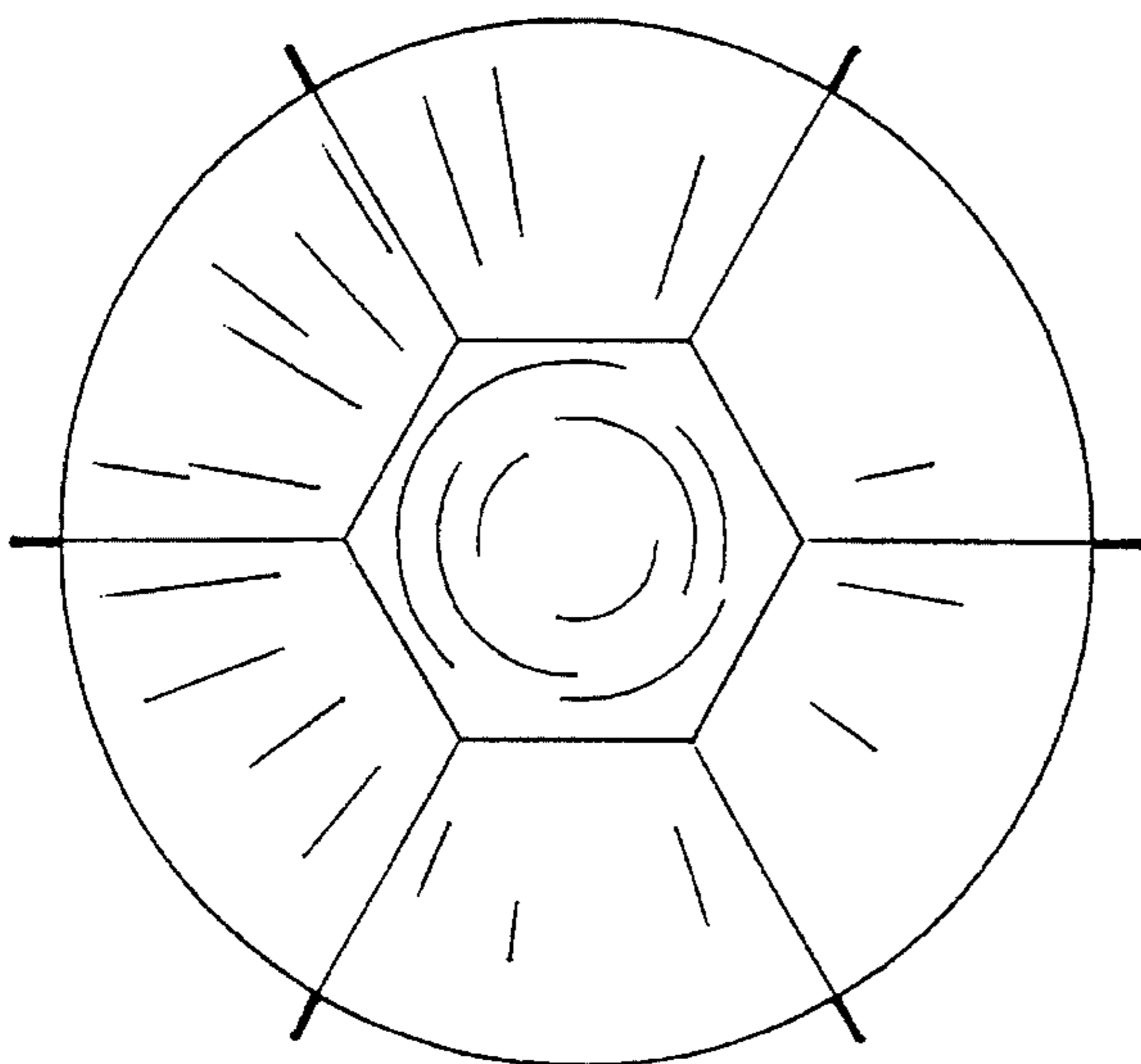

FIG. 32

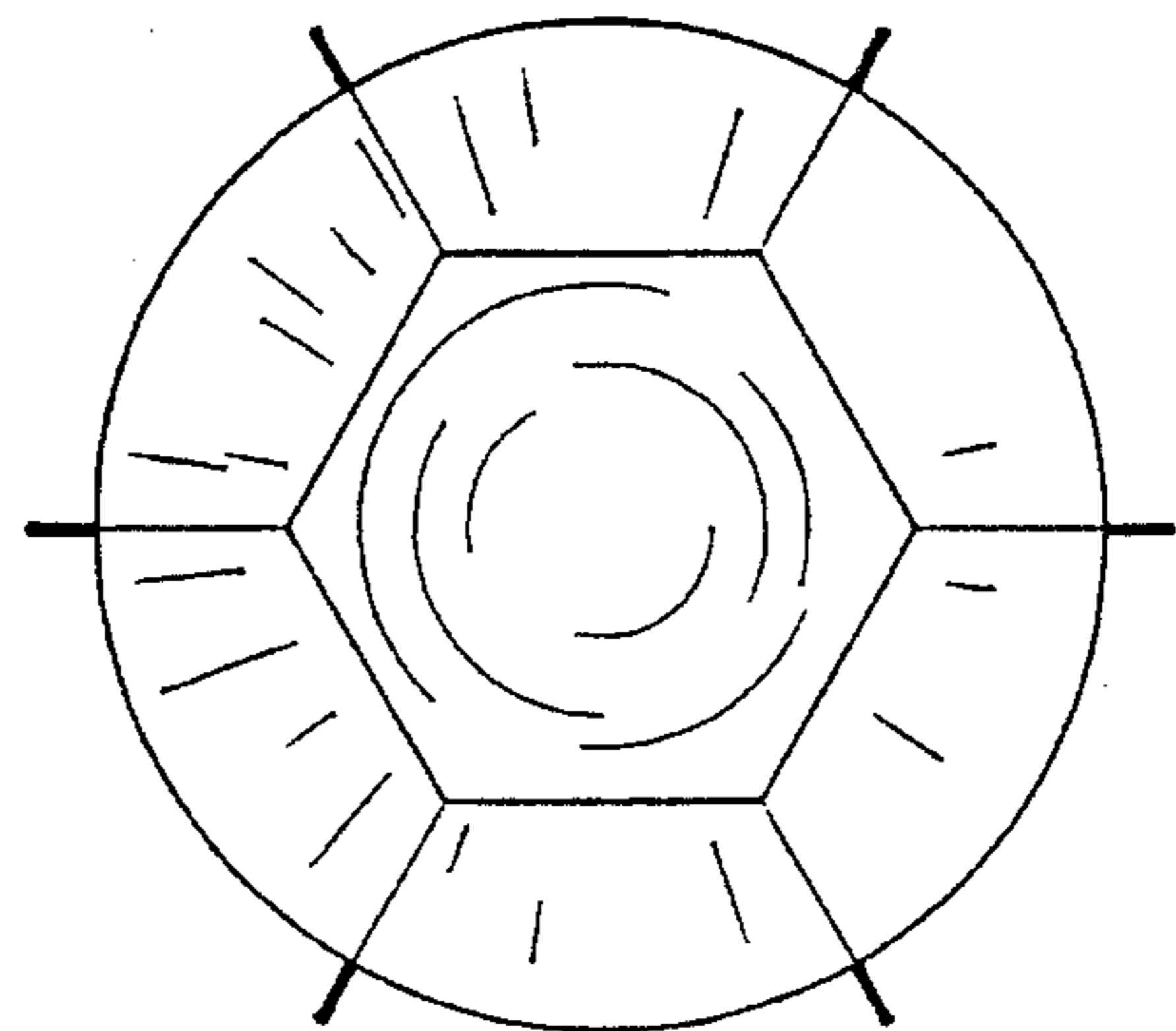

FIG. 33

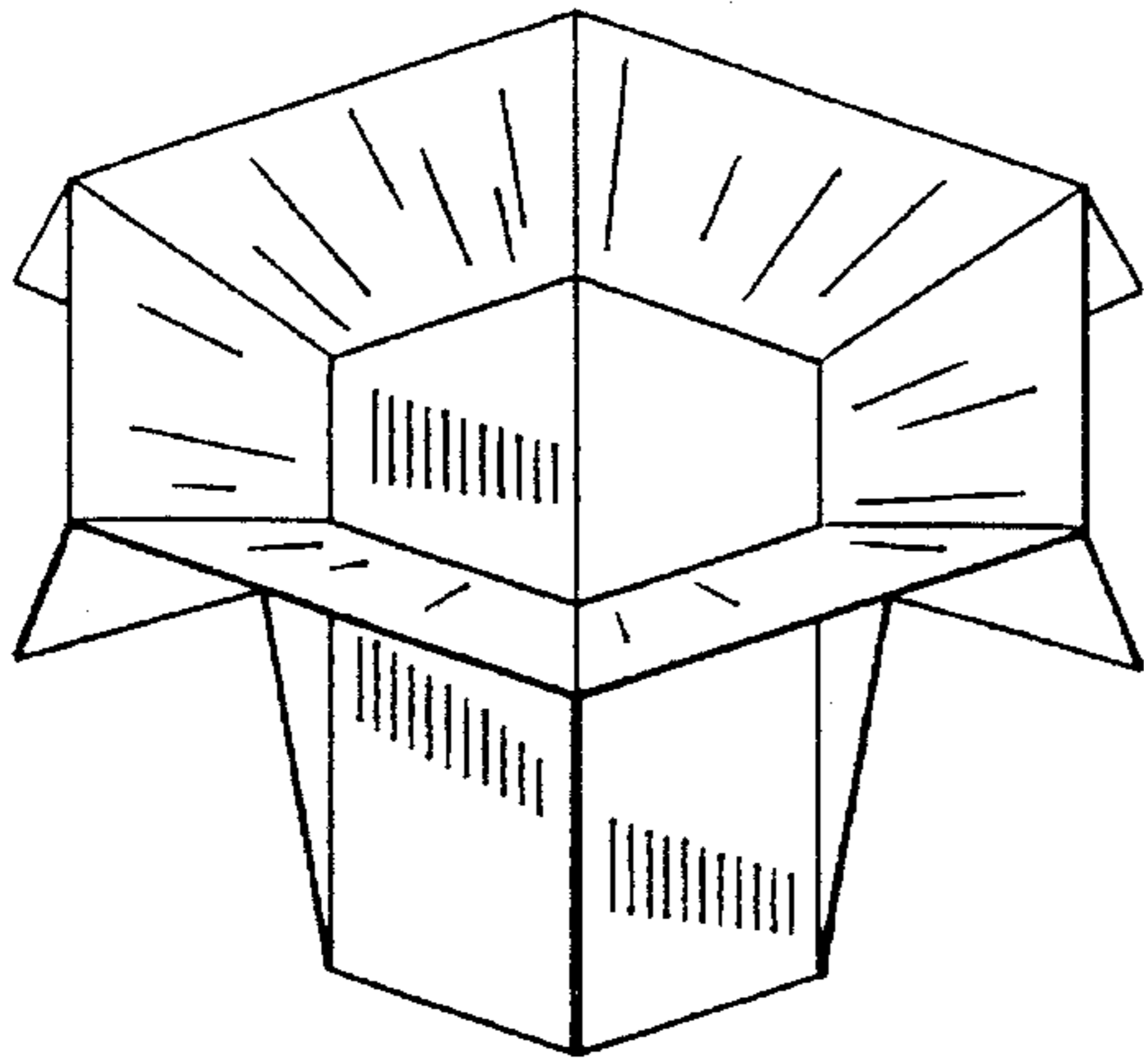

FIG. 34

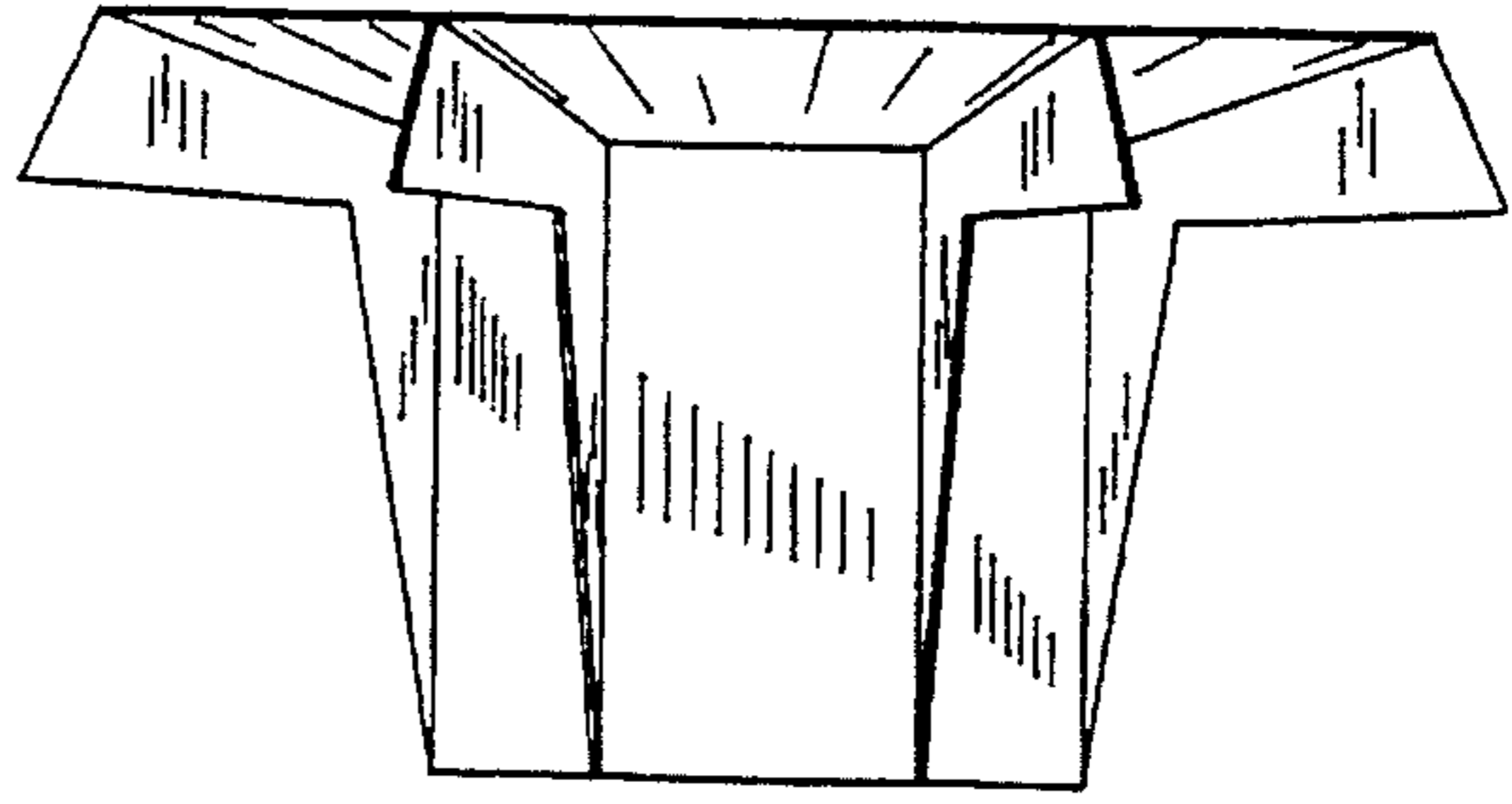

FIG. 35

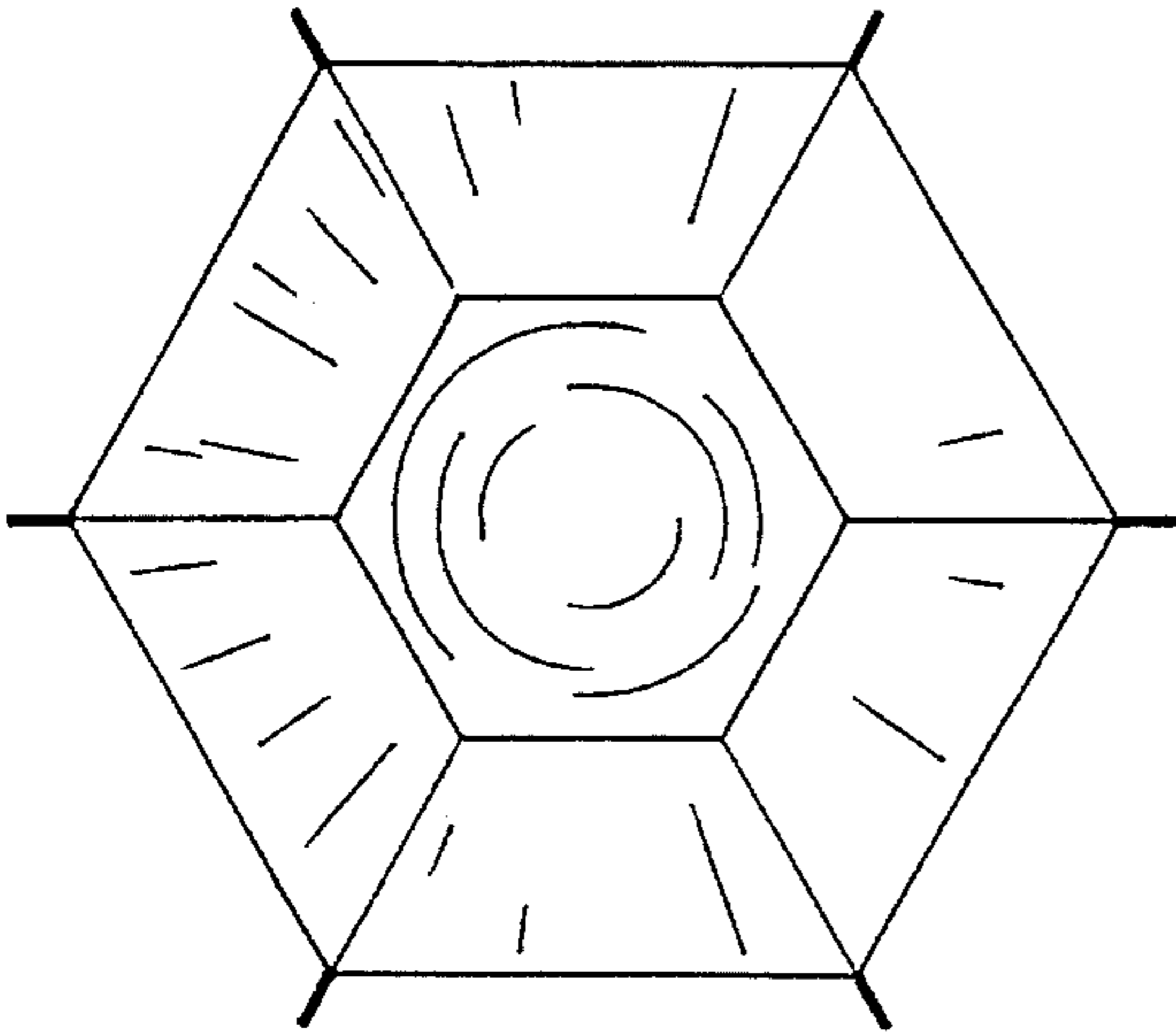

FIG. 36

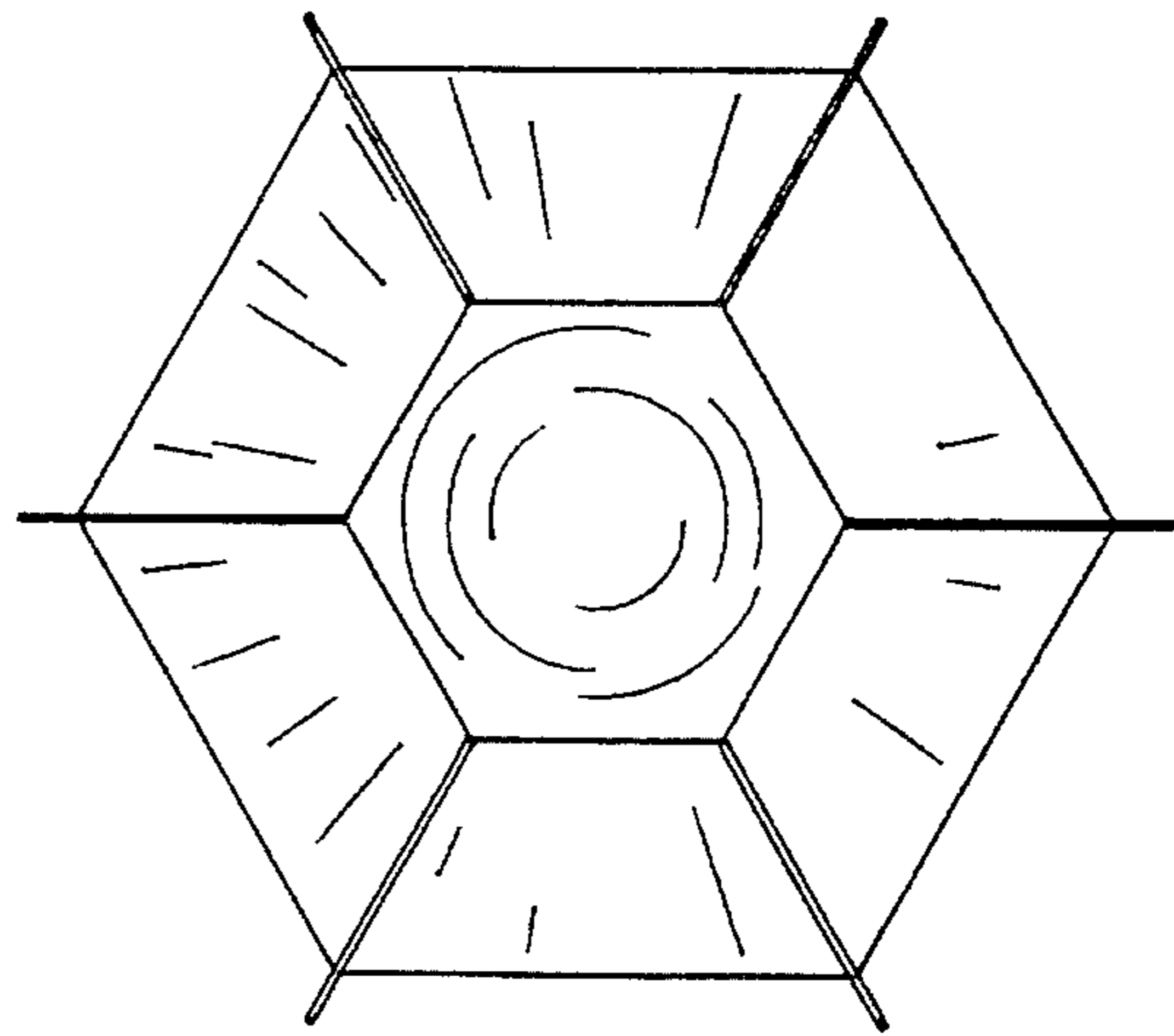

FIG. 37

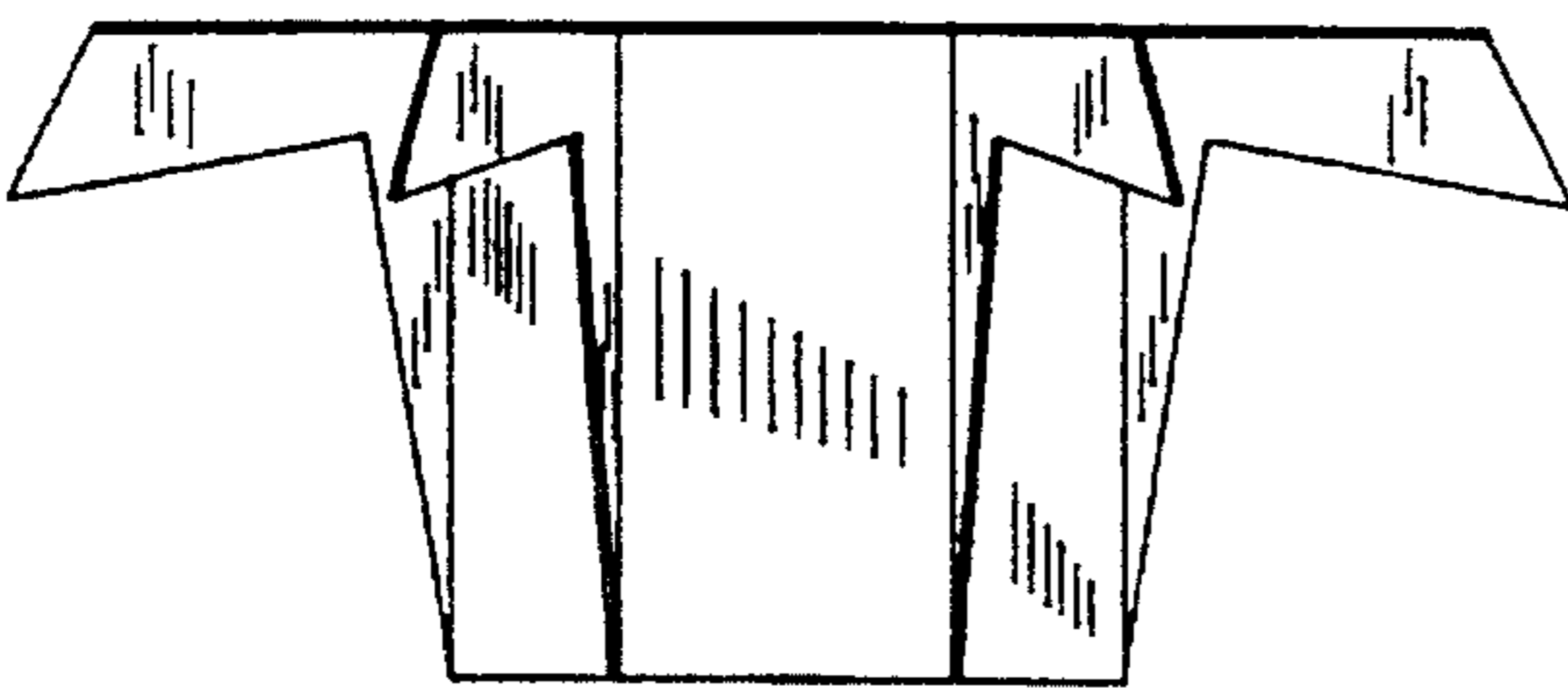

FIG. 38

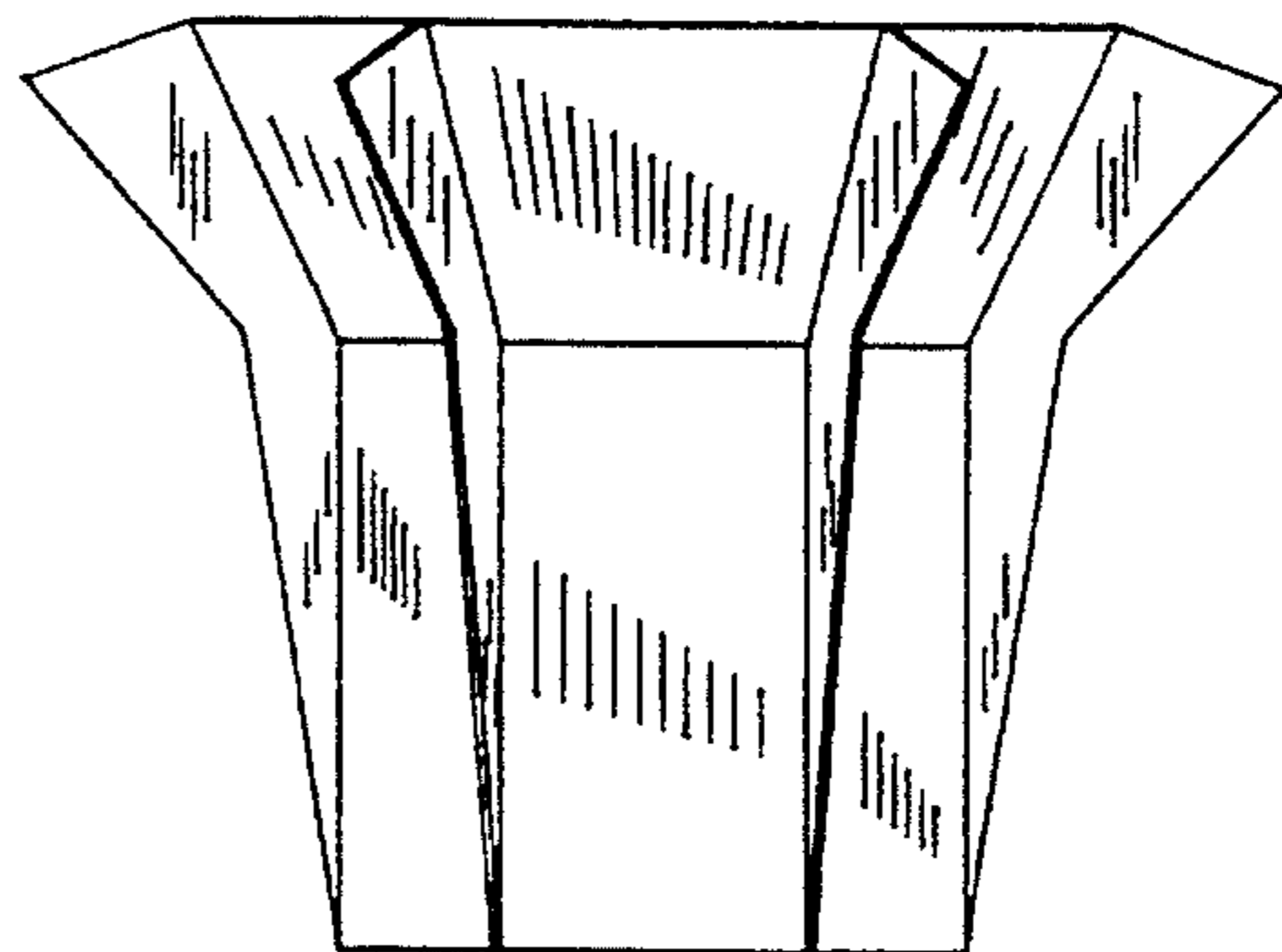

FIG. 39

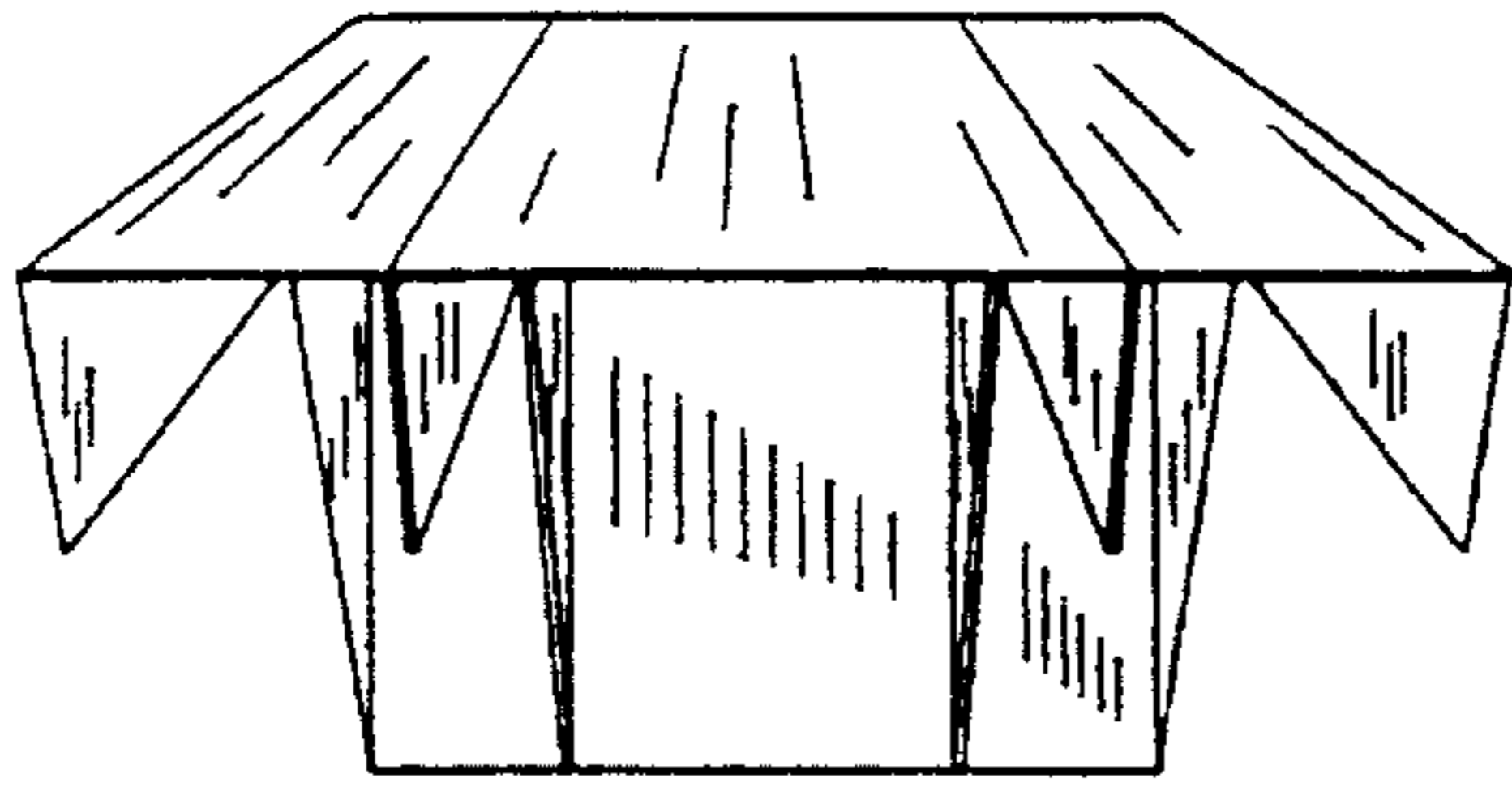

FIG. 40

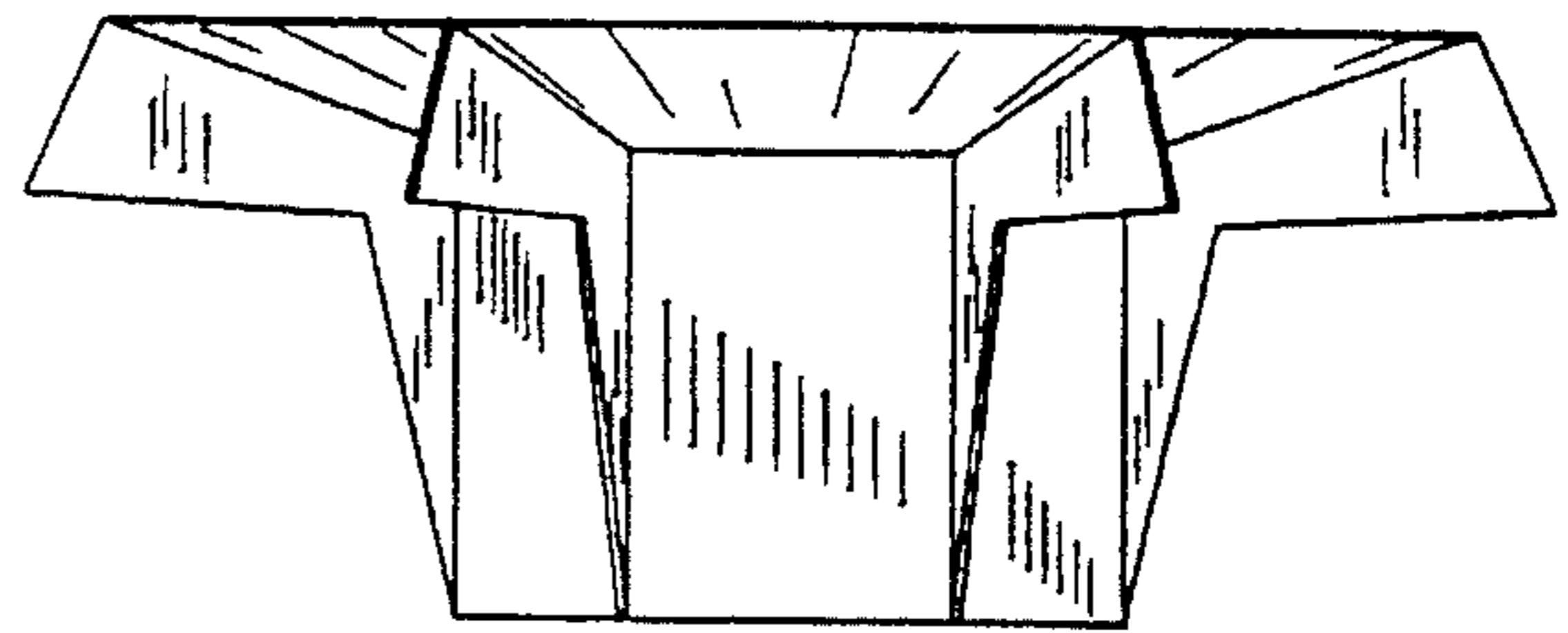

FIG. 41

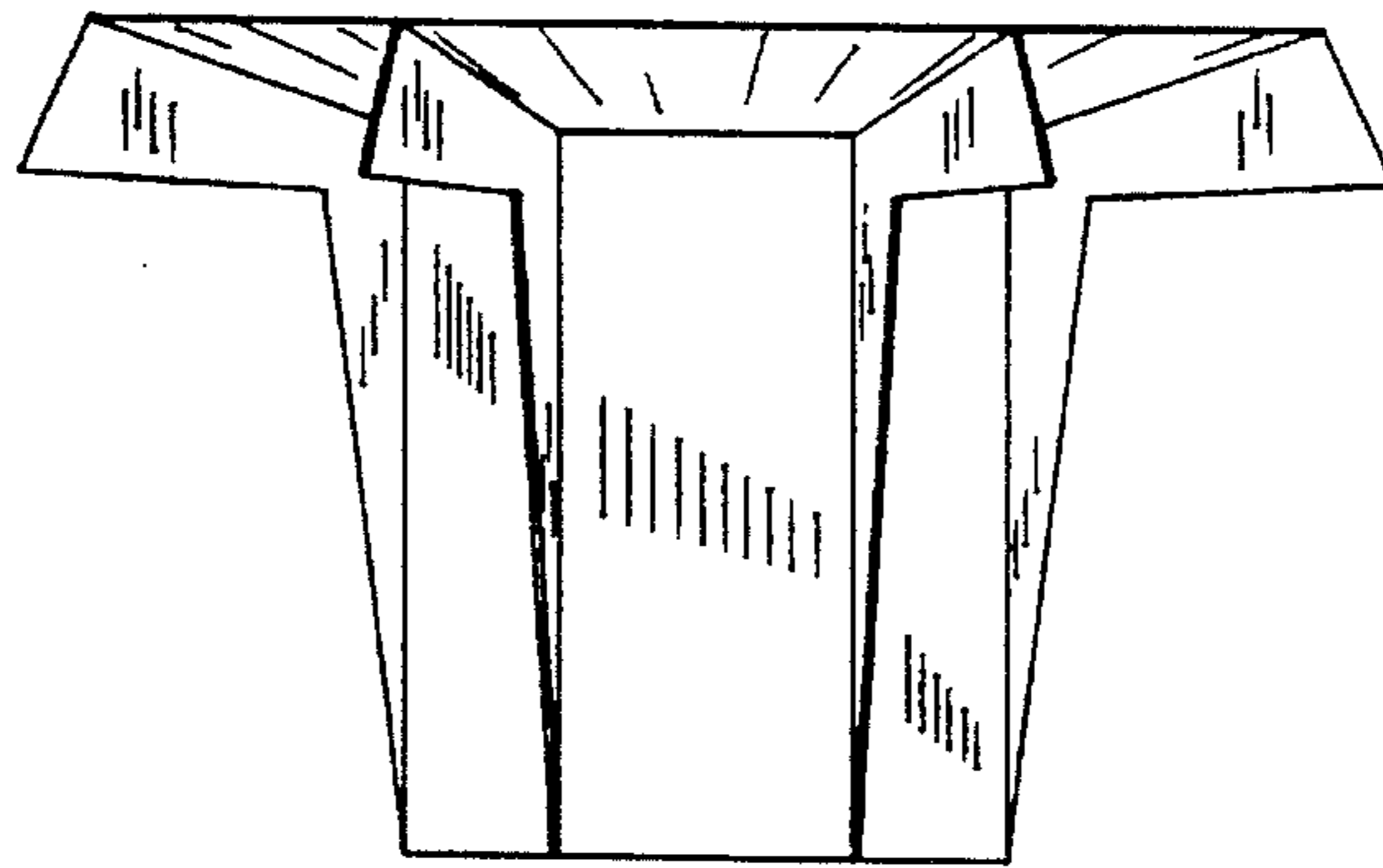

FIG. 42

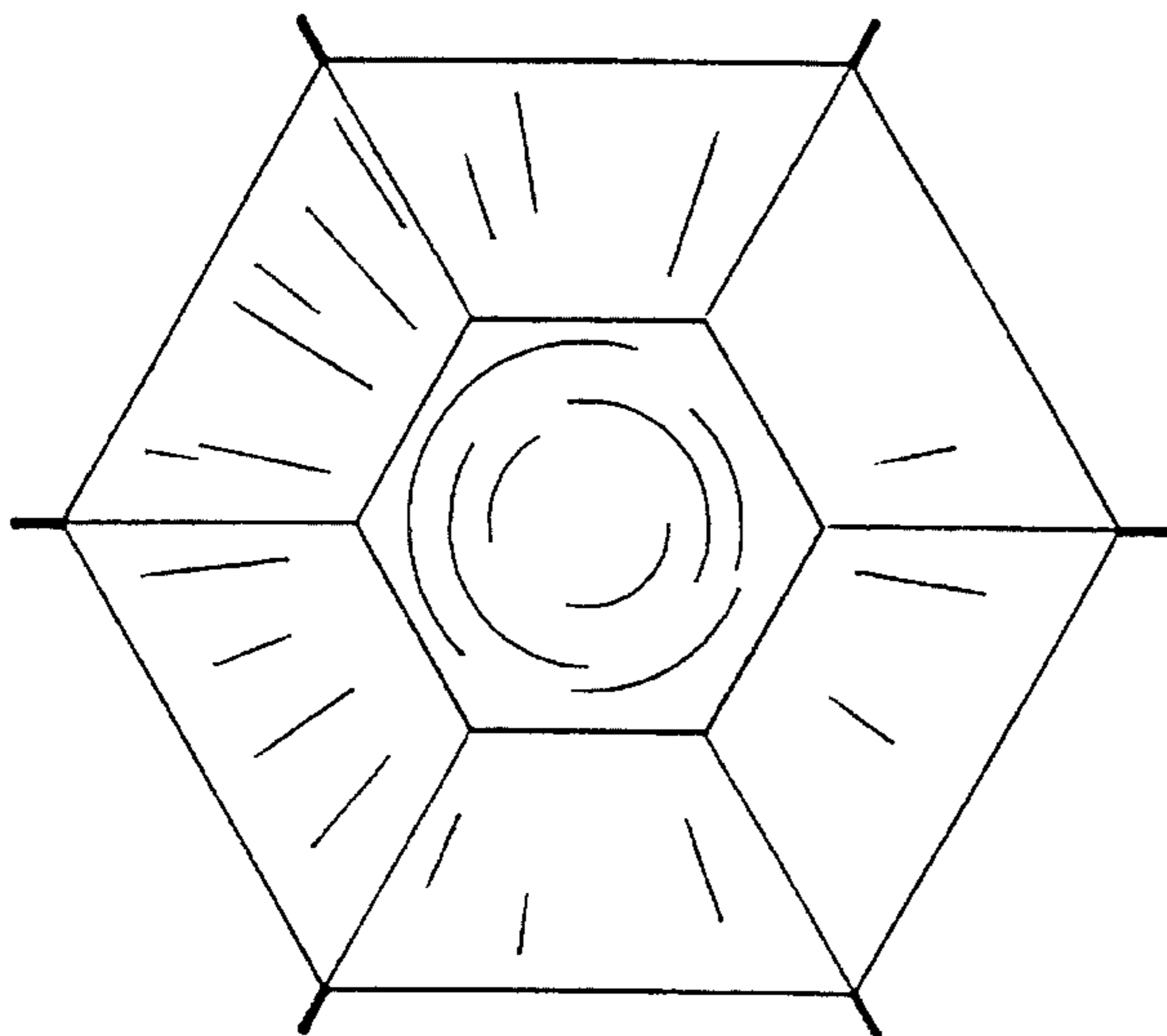

FIG. 43

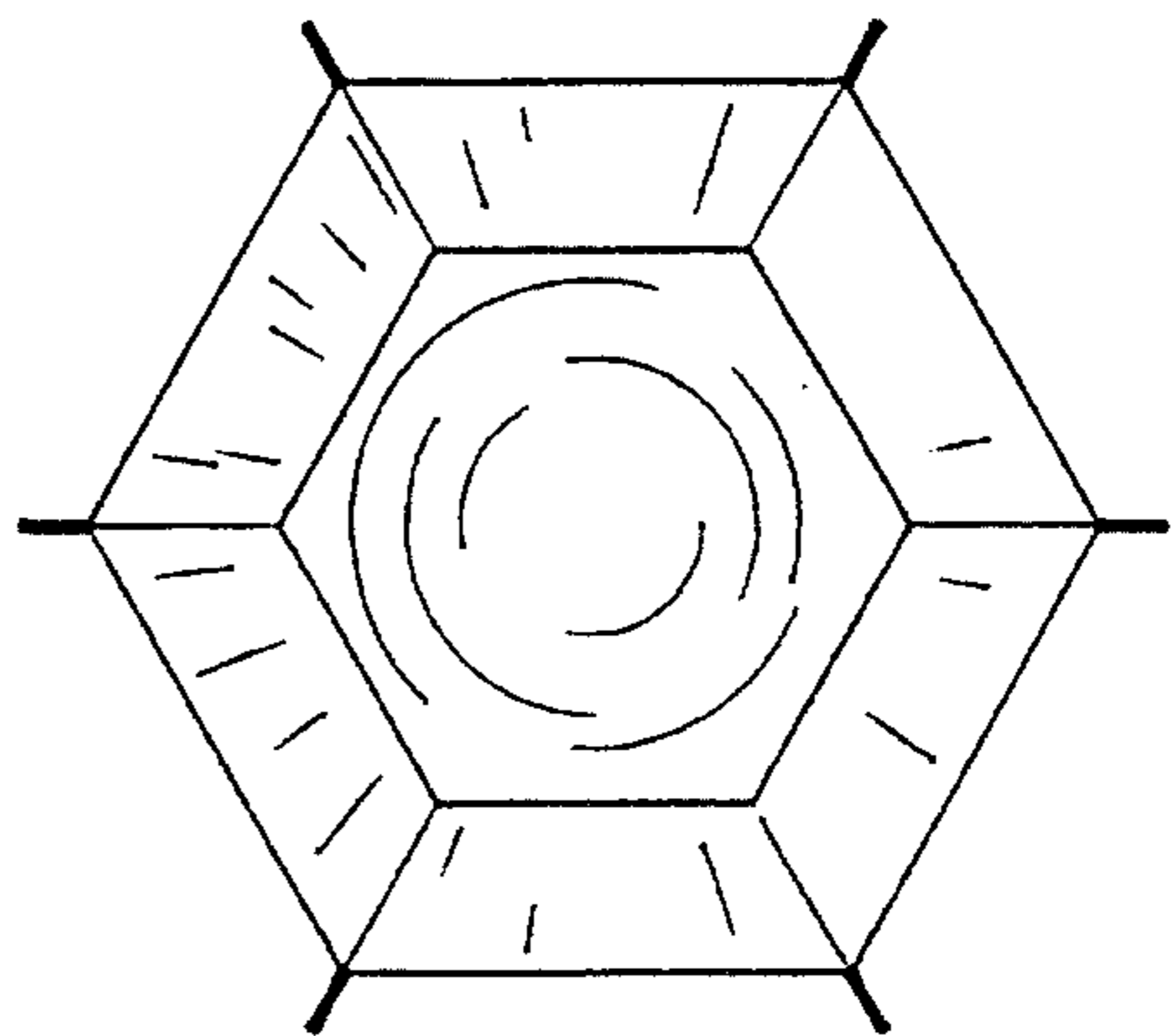

FIG. 44

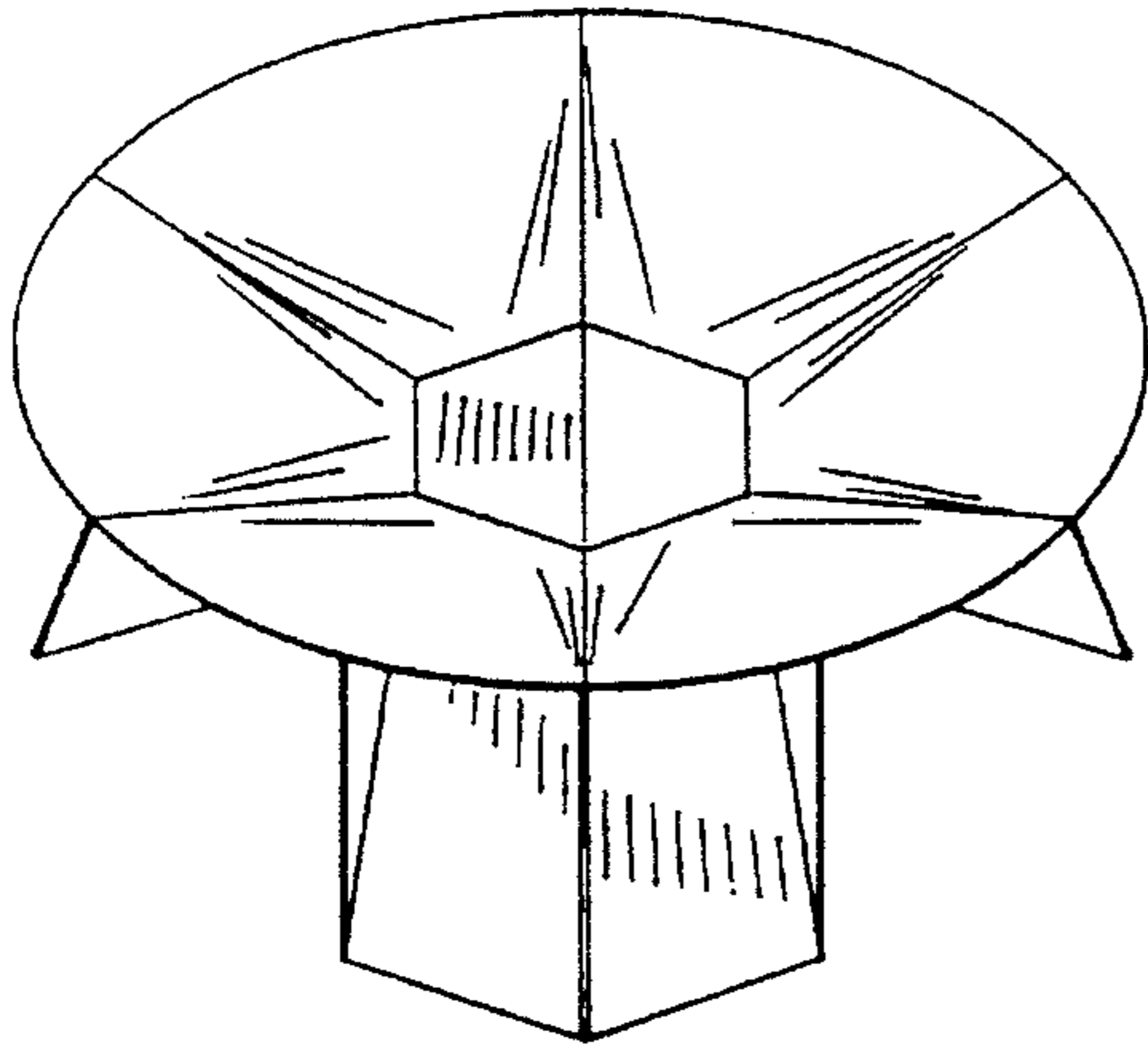

FIG. 45

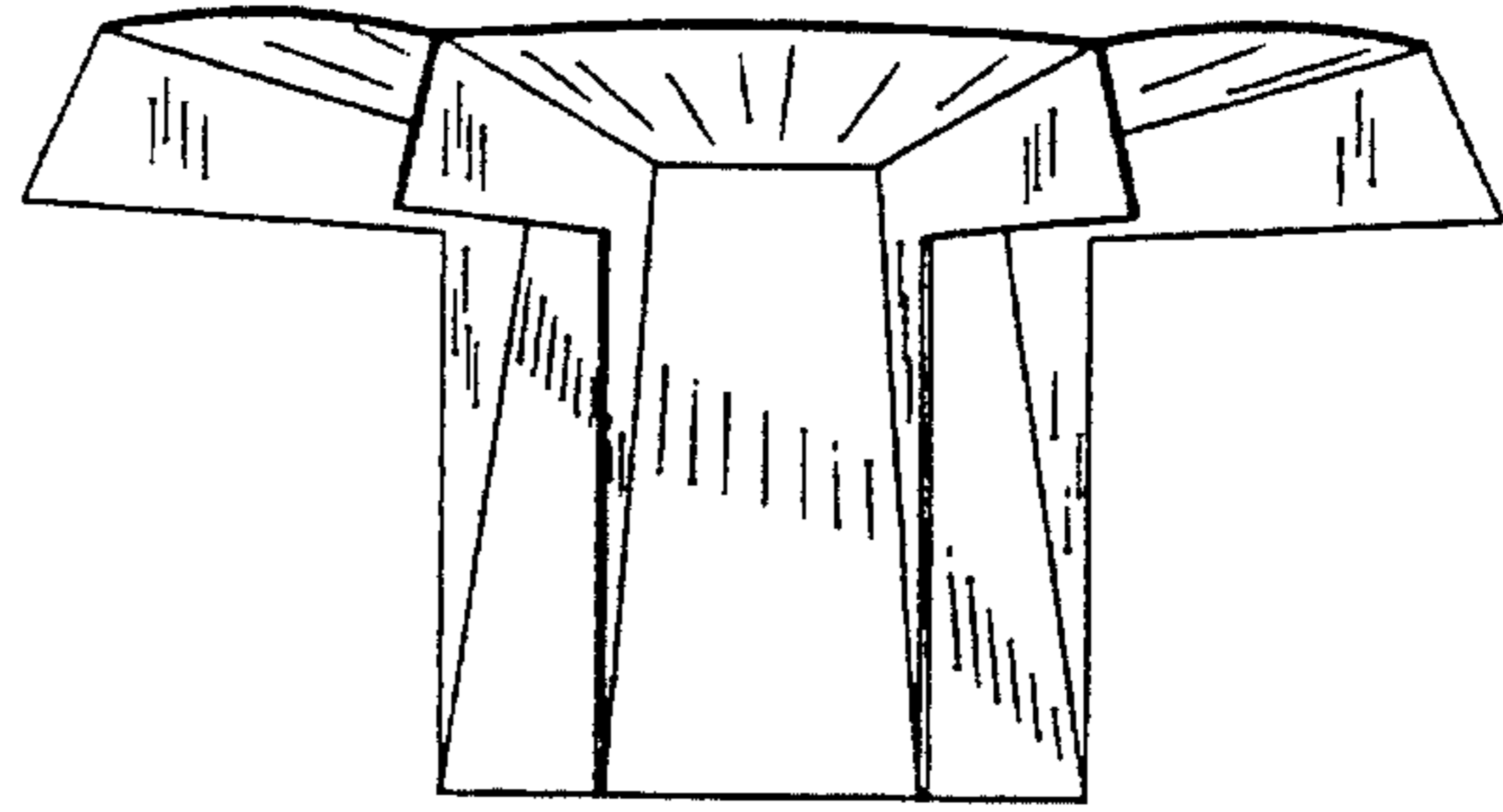

FIG. 46

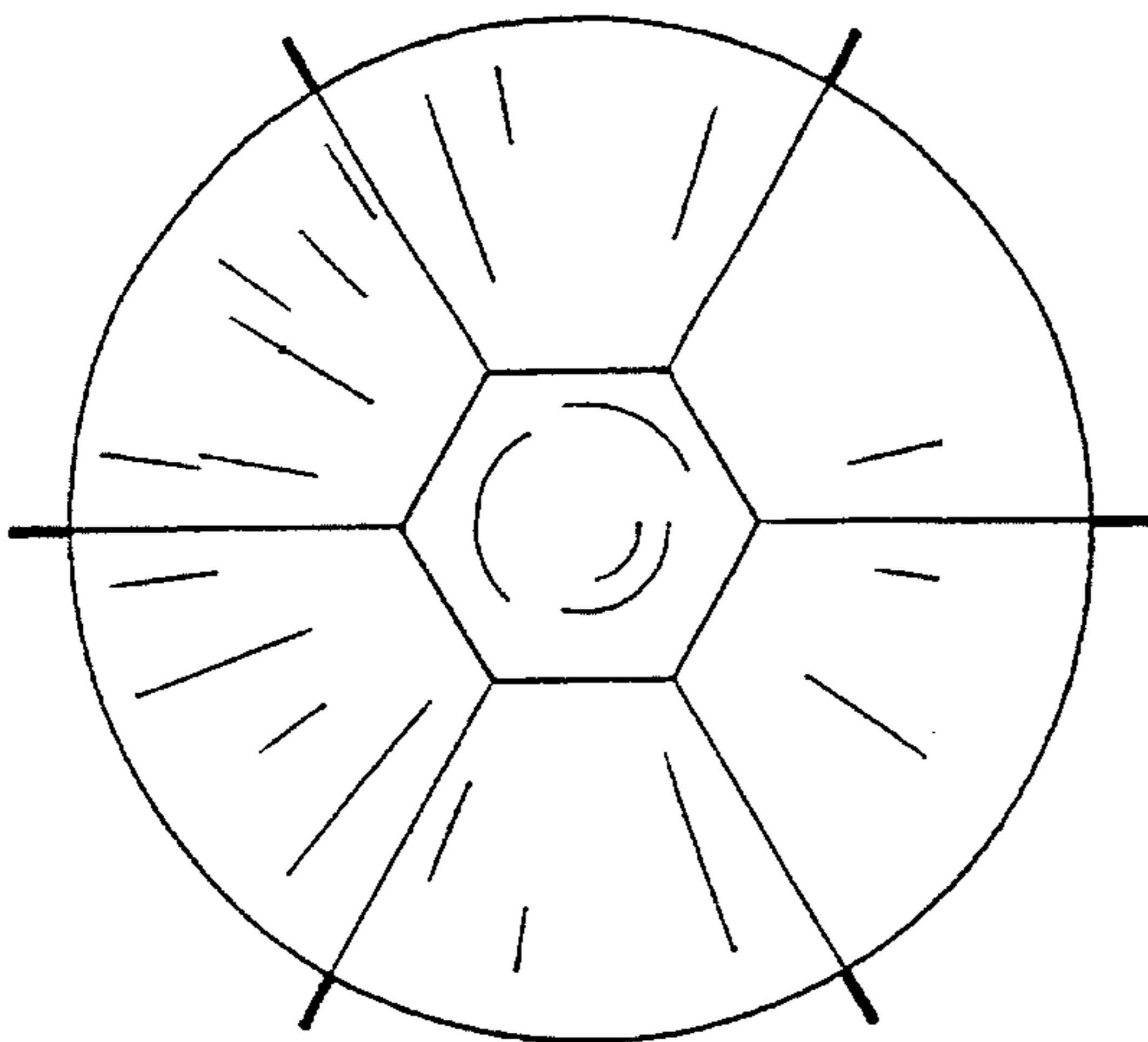

FIG. 47

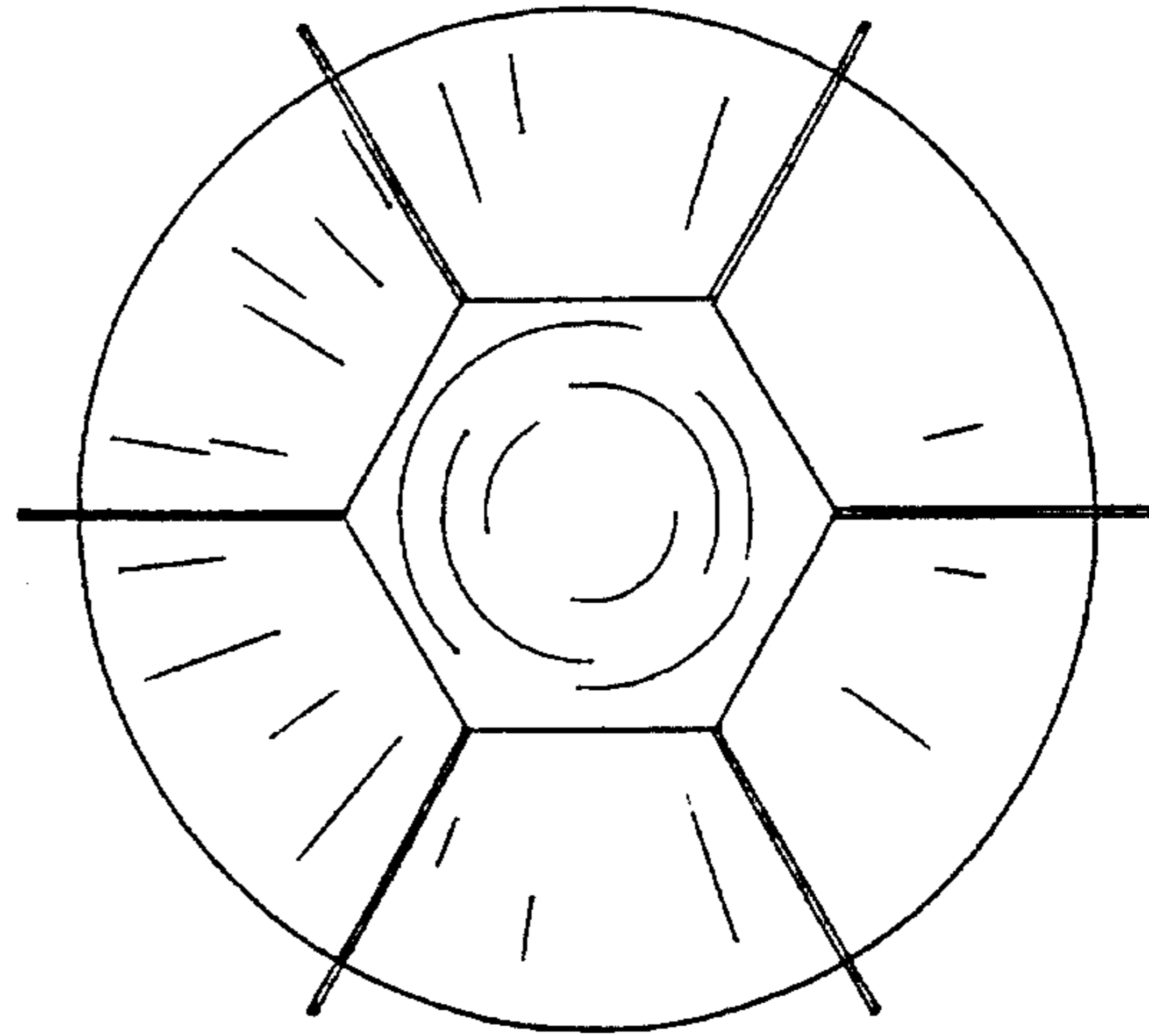

FIG. 48

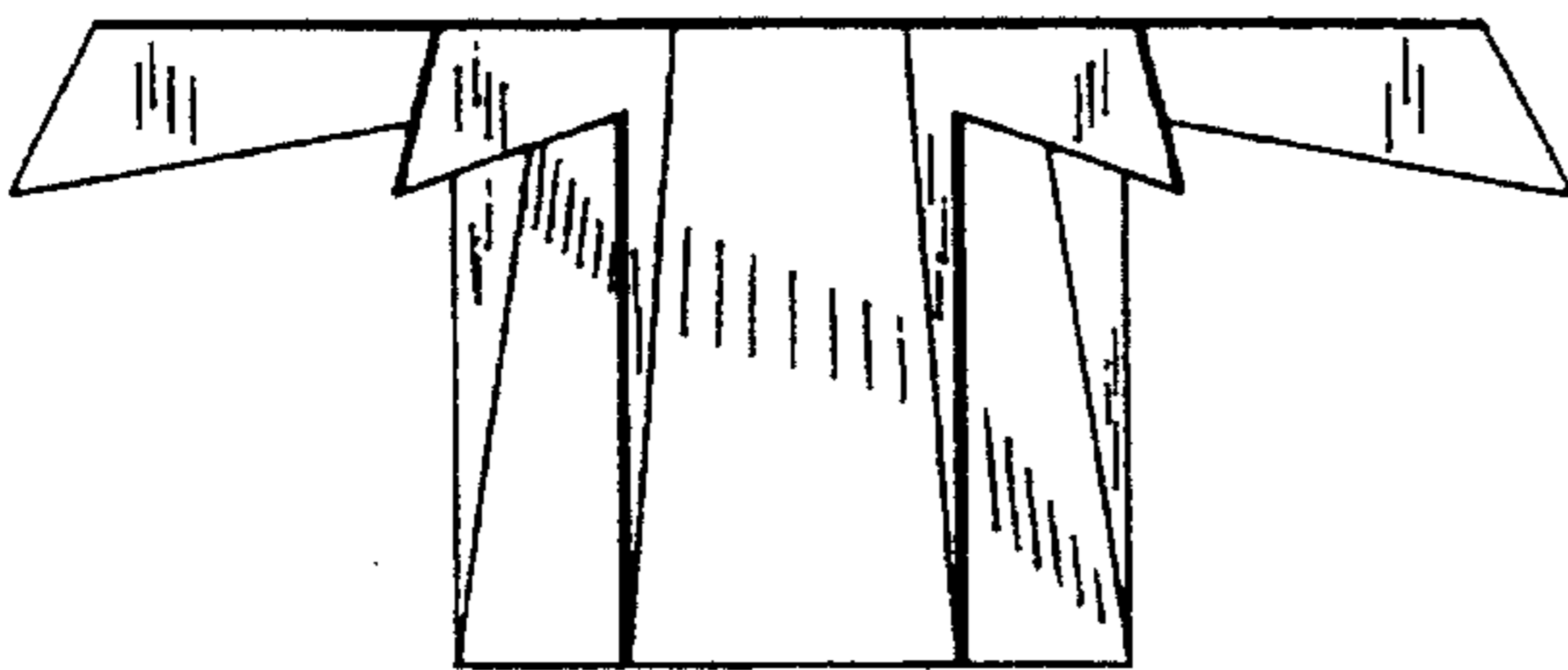

FIG. 49

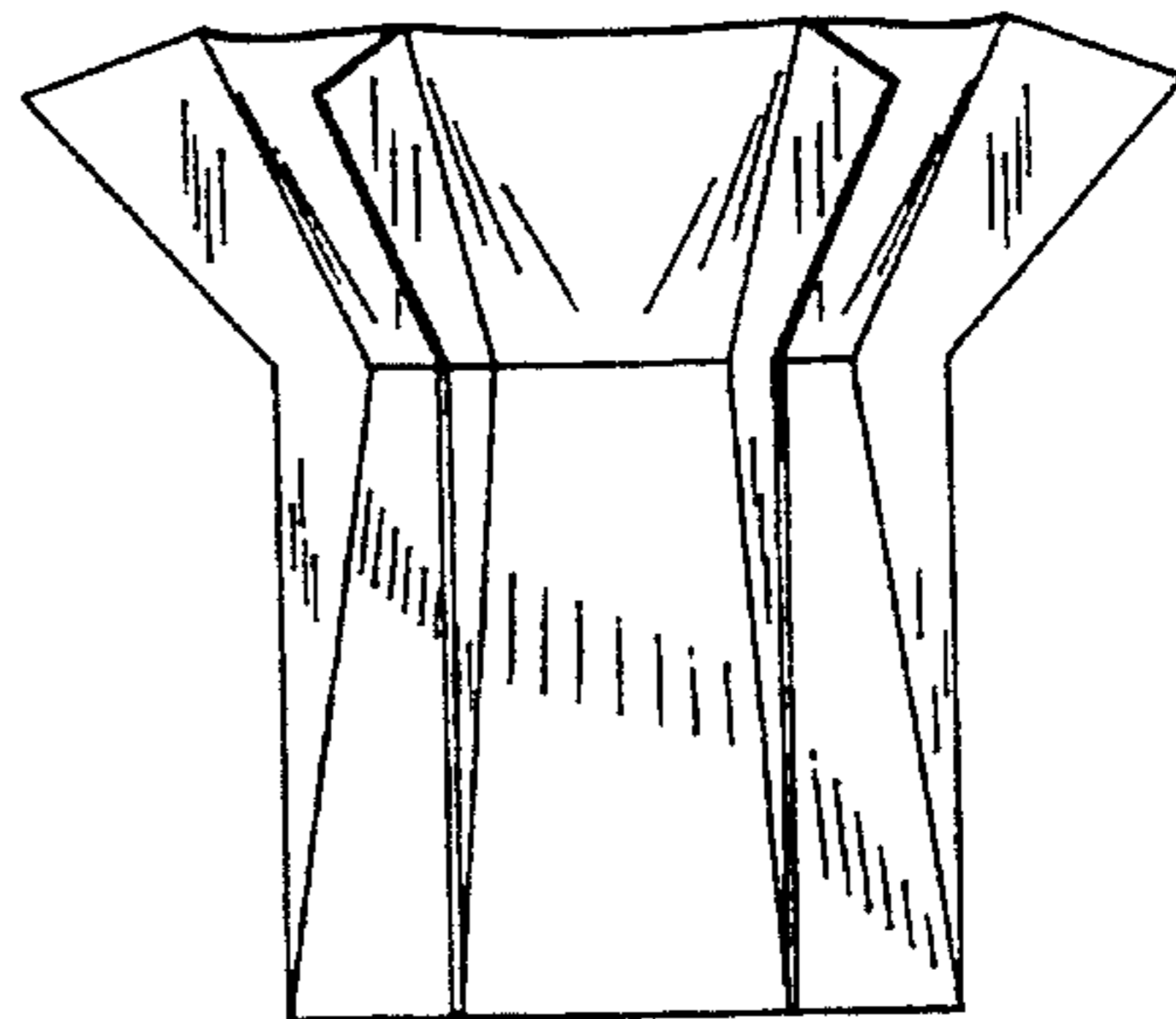

FIG. 50

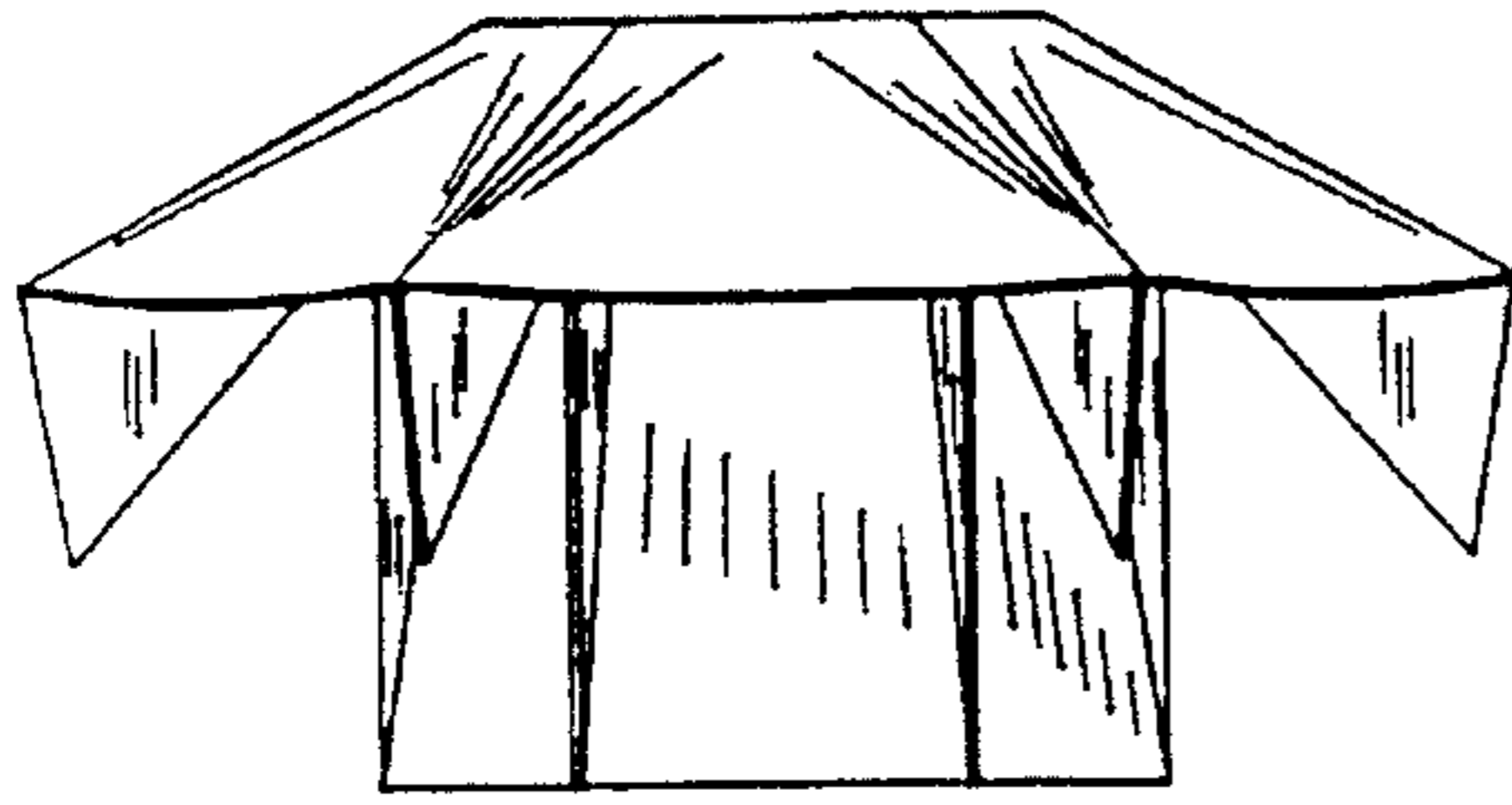

FIG. 51

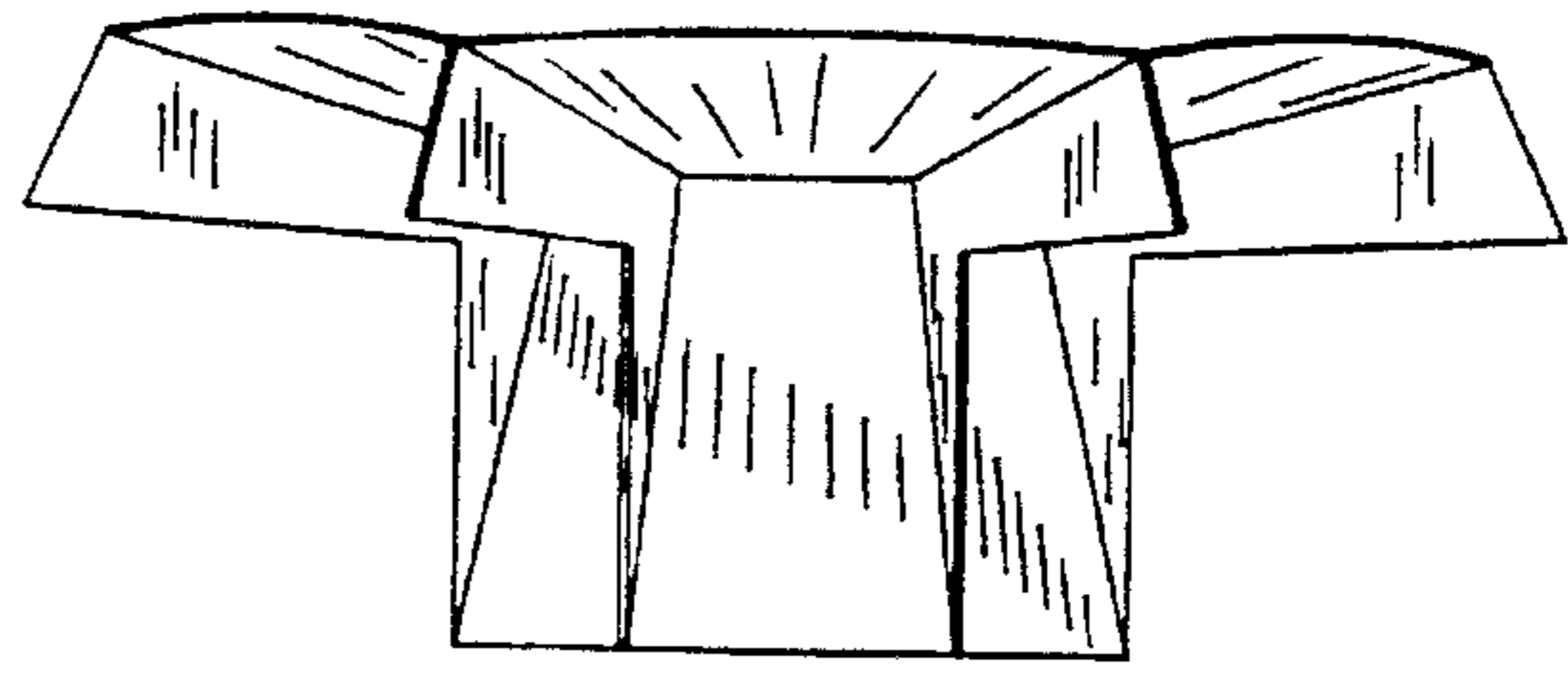

FIG. 52

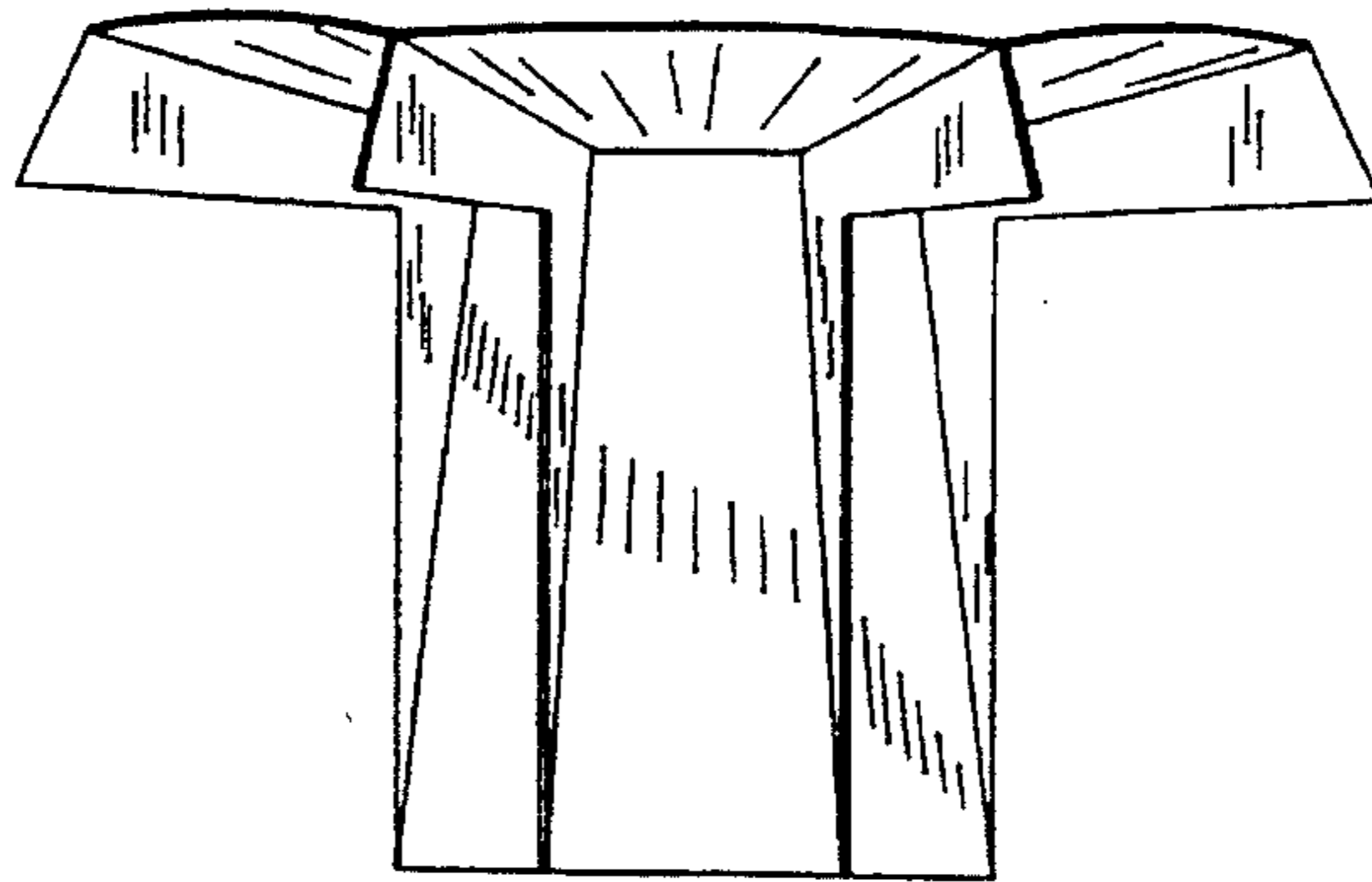

FIG. 53

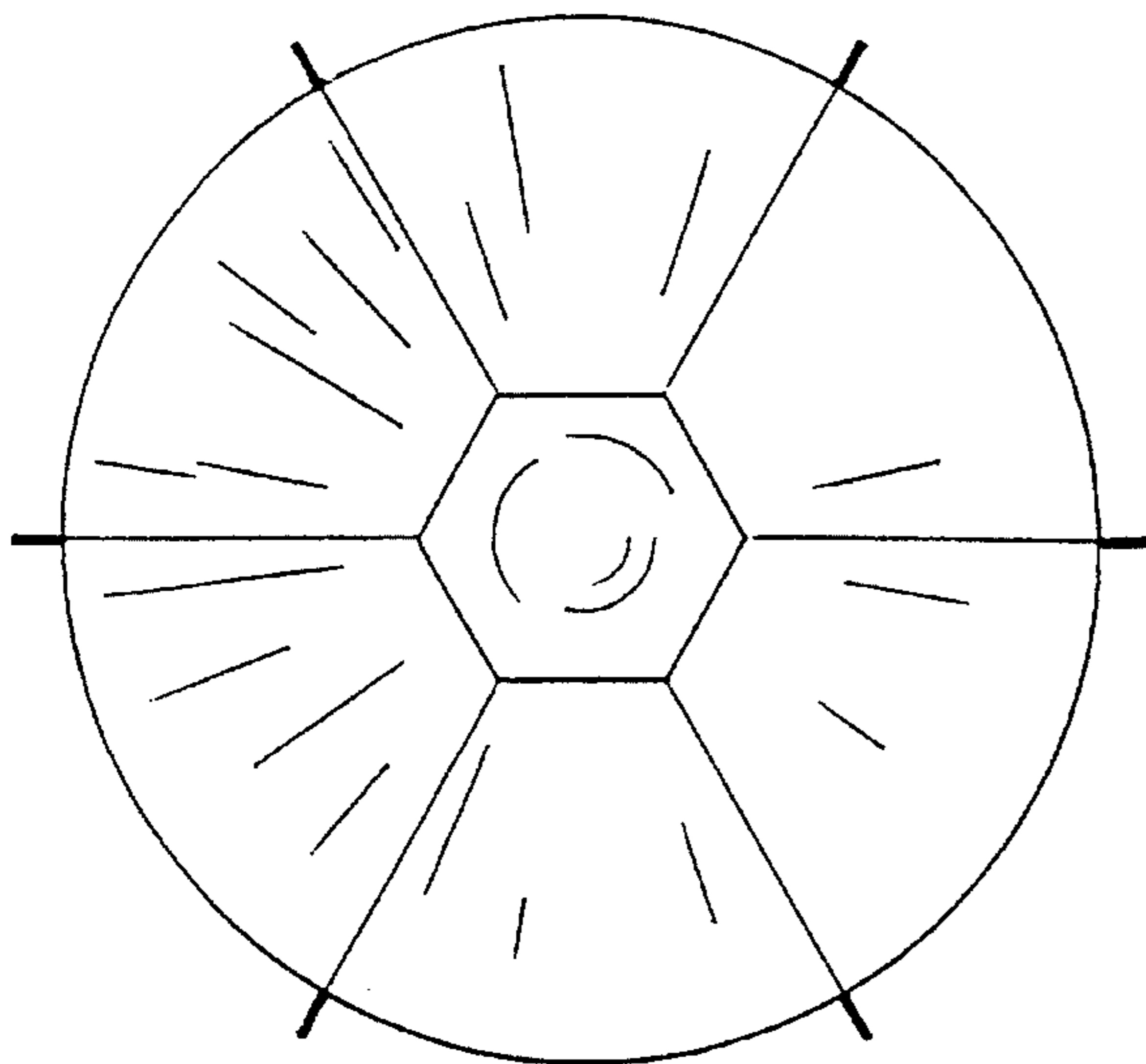

FIG. 54

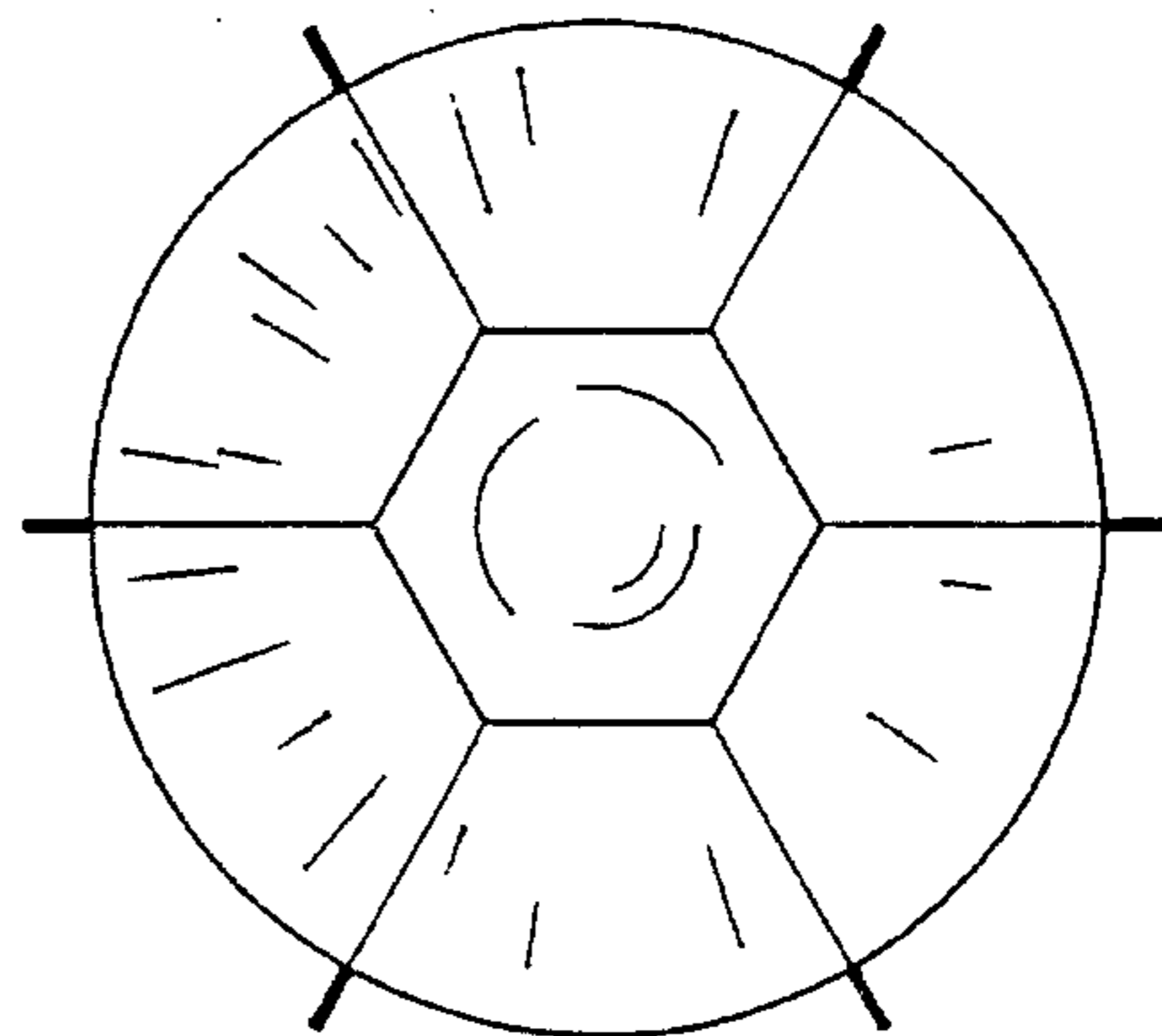

FIG. 55

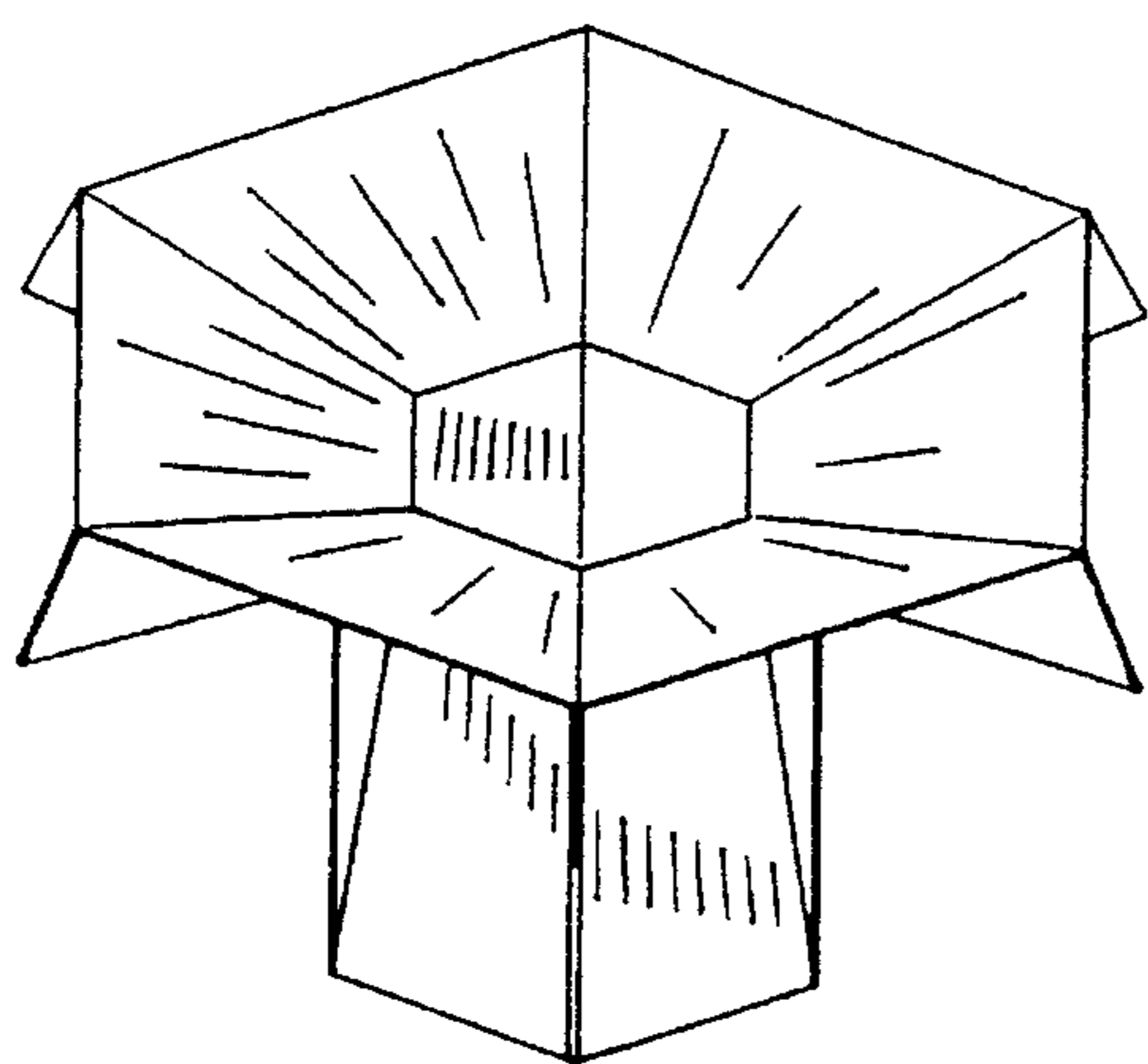

FIG. 55

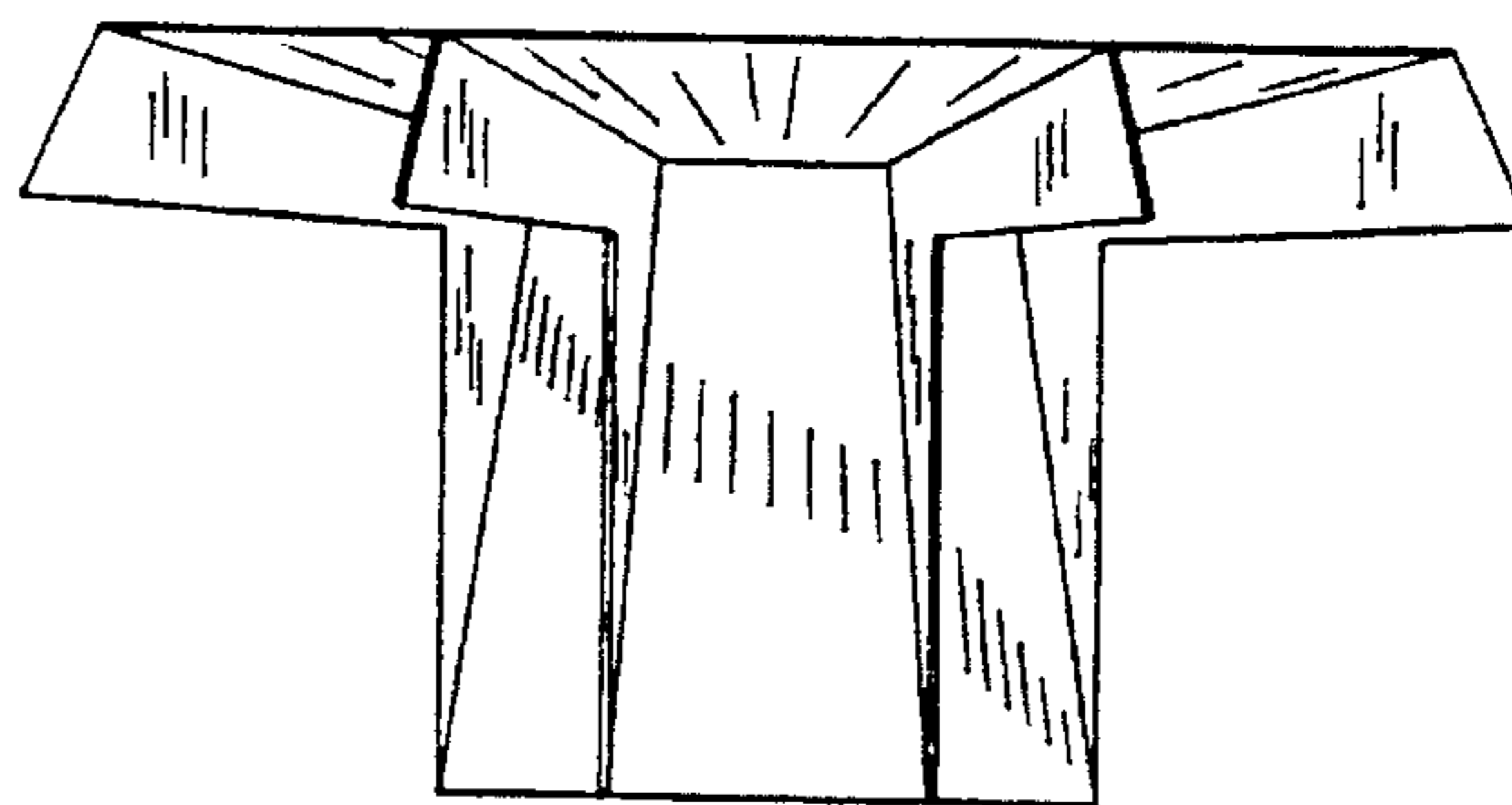

FIG. 57

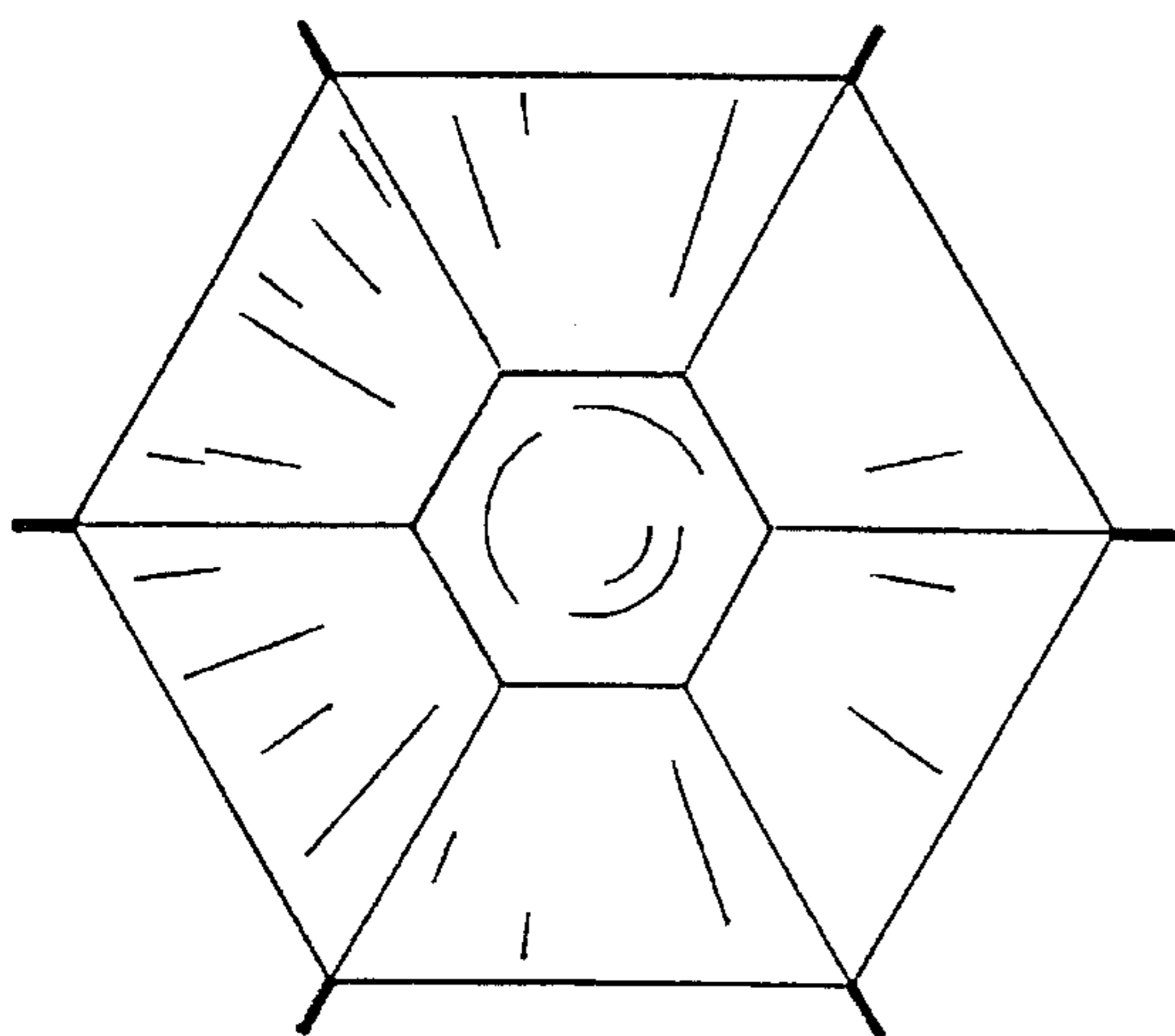

FIG. 58

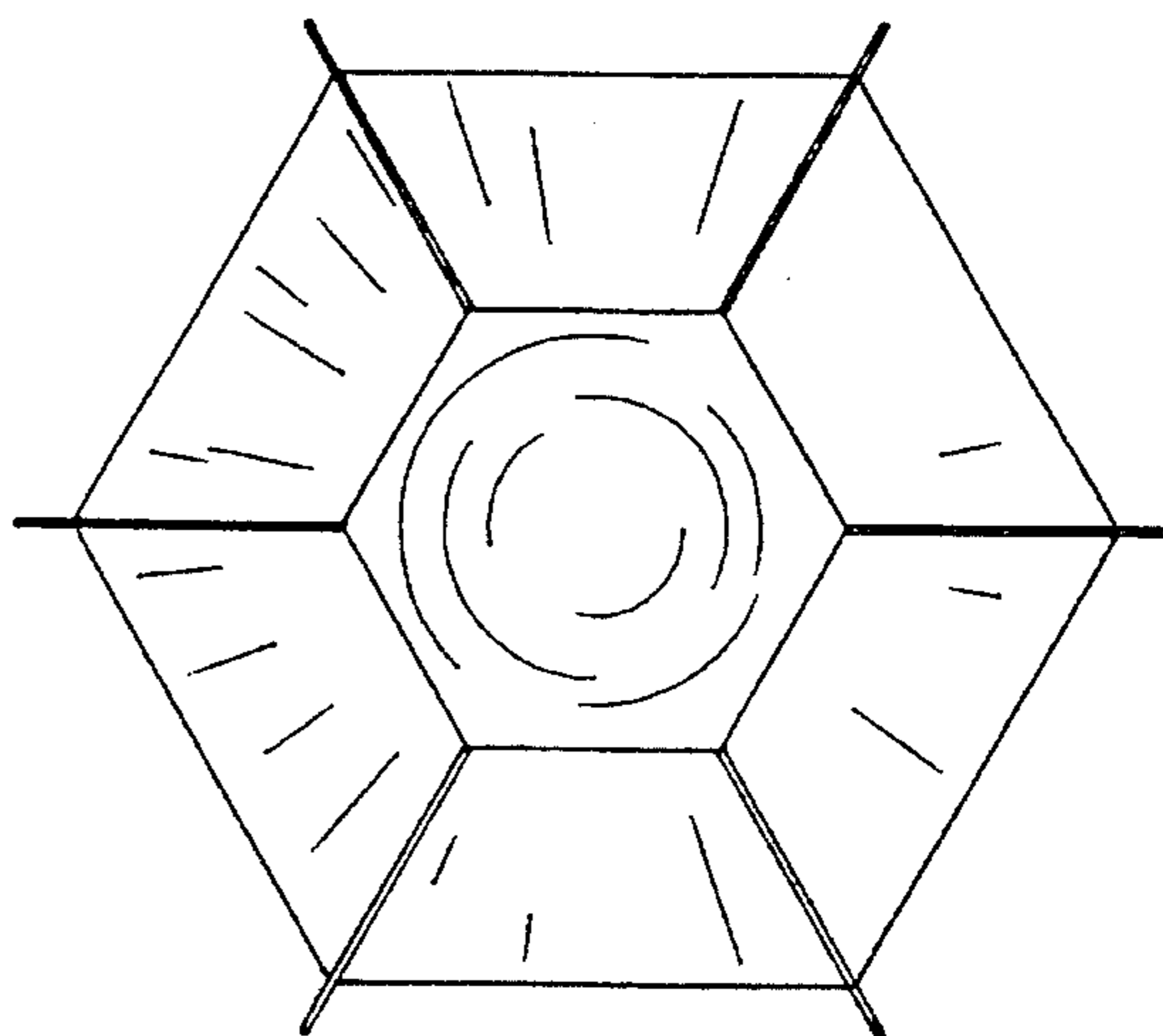

FIG. 59

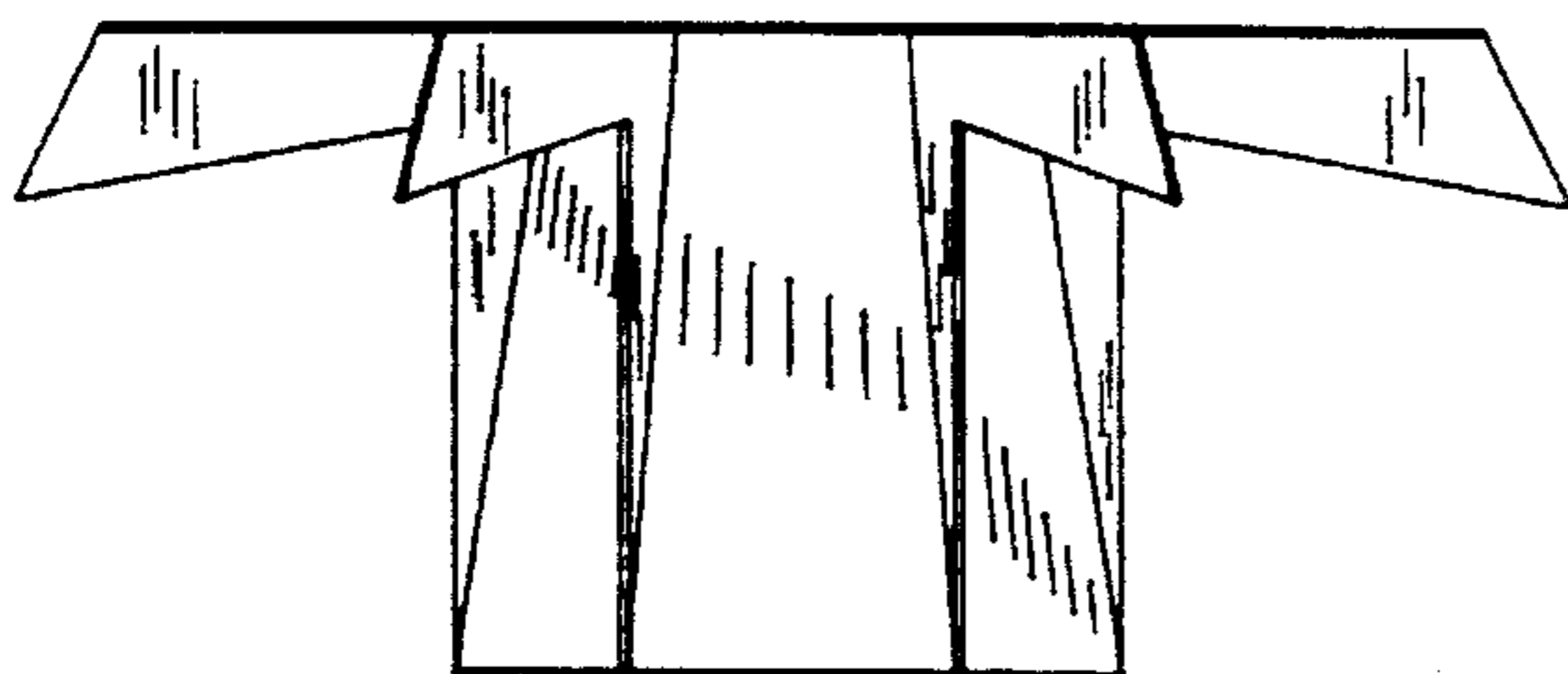

FIG. 60

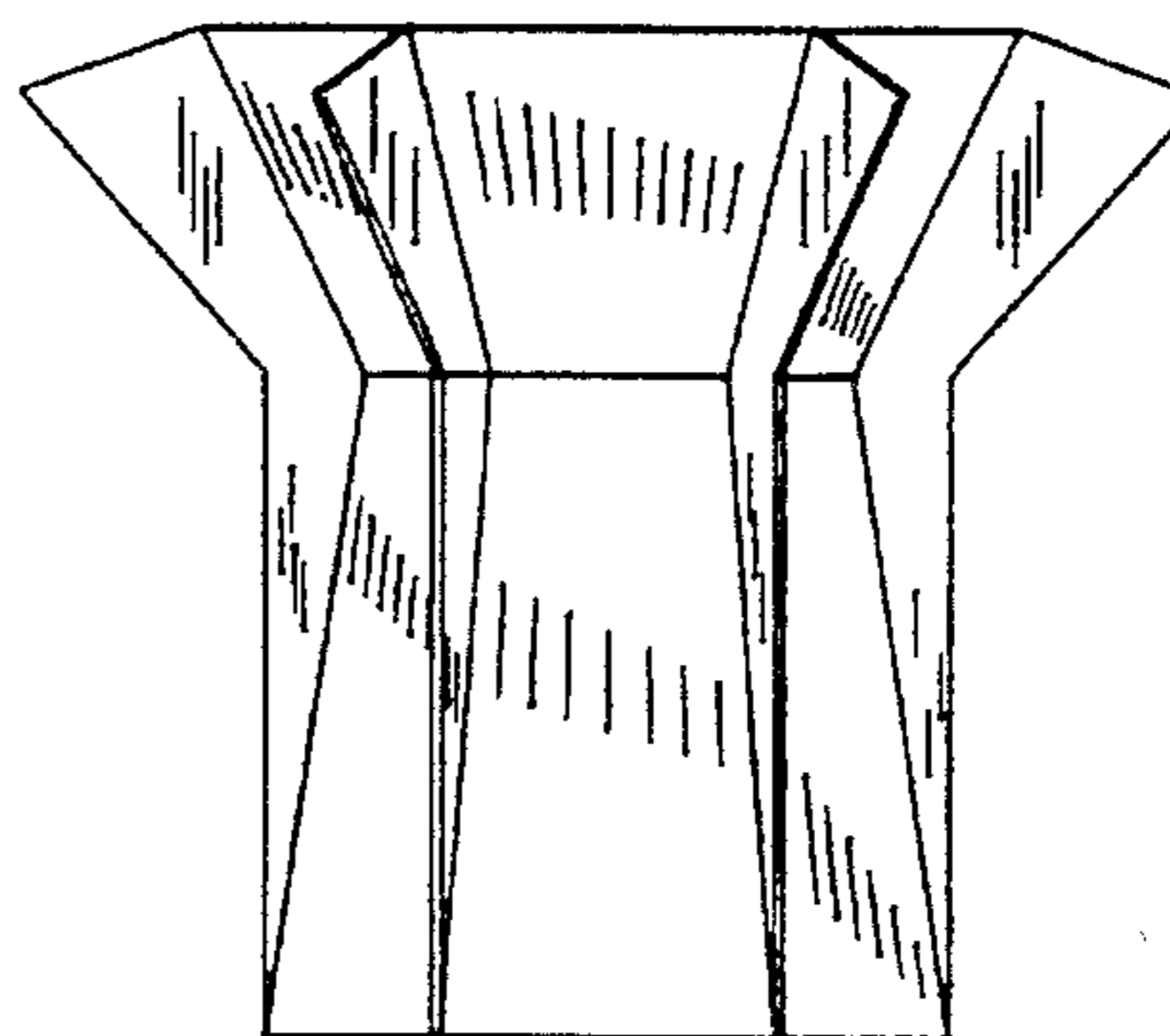

FIG. 61

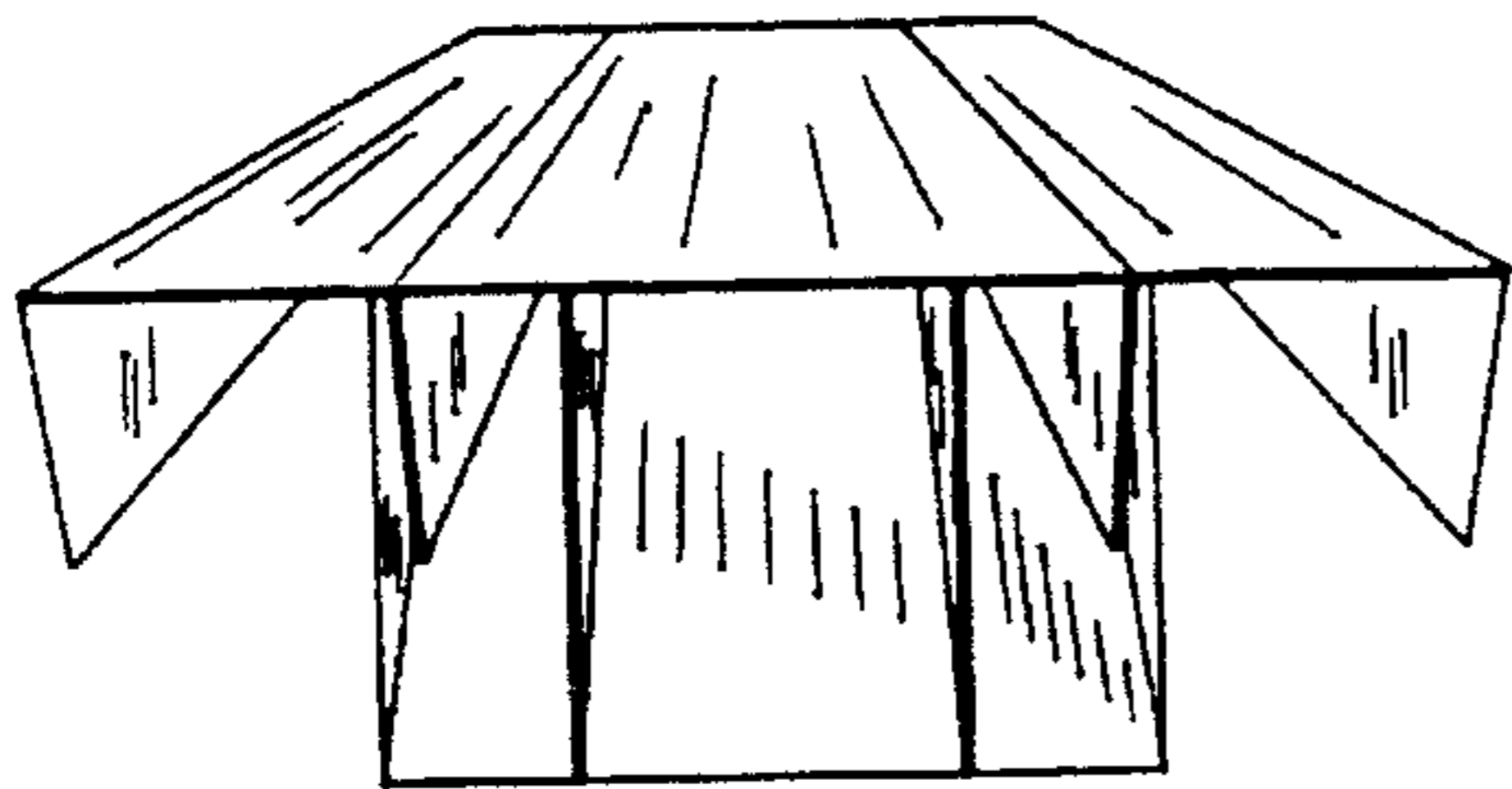

FIG. 52

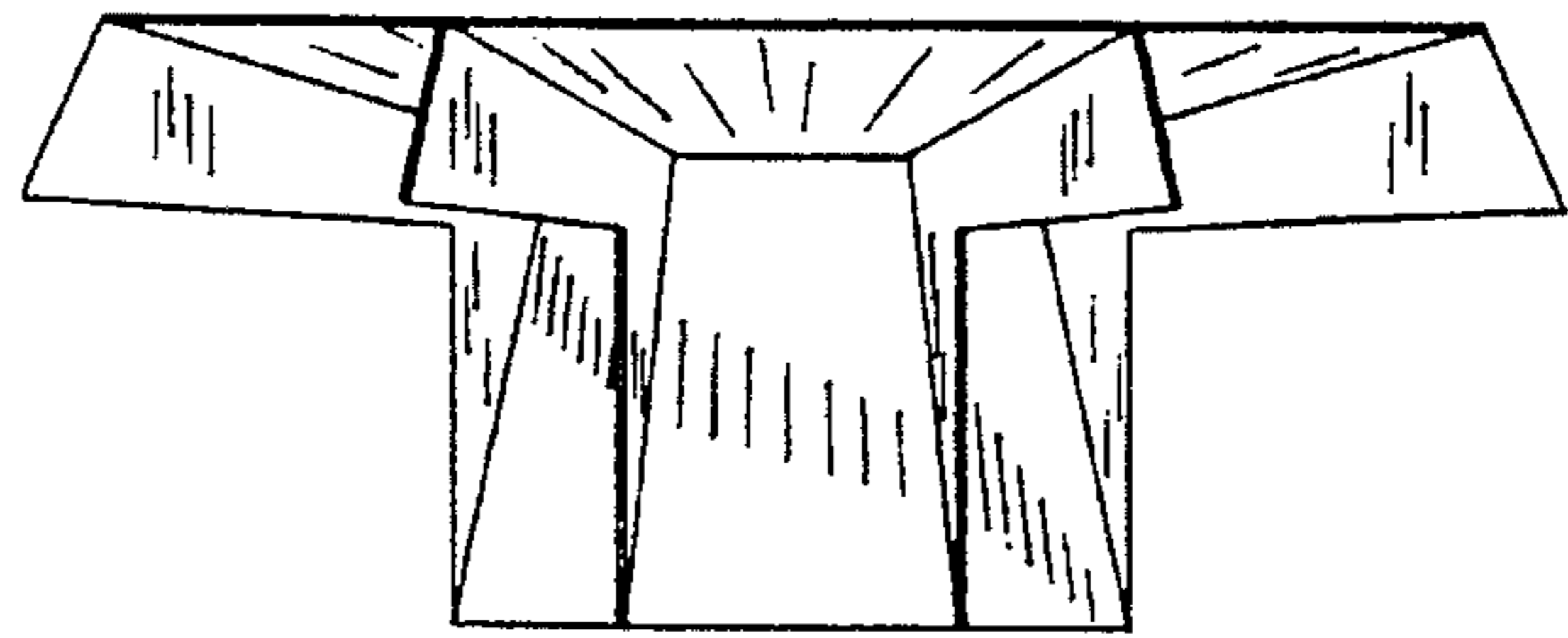

FIG. 53

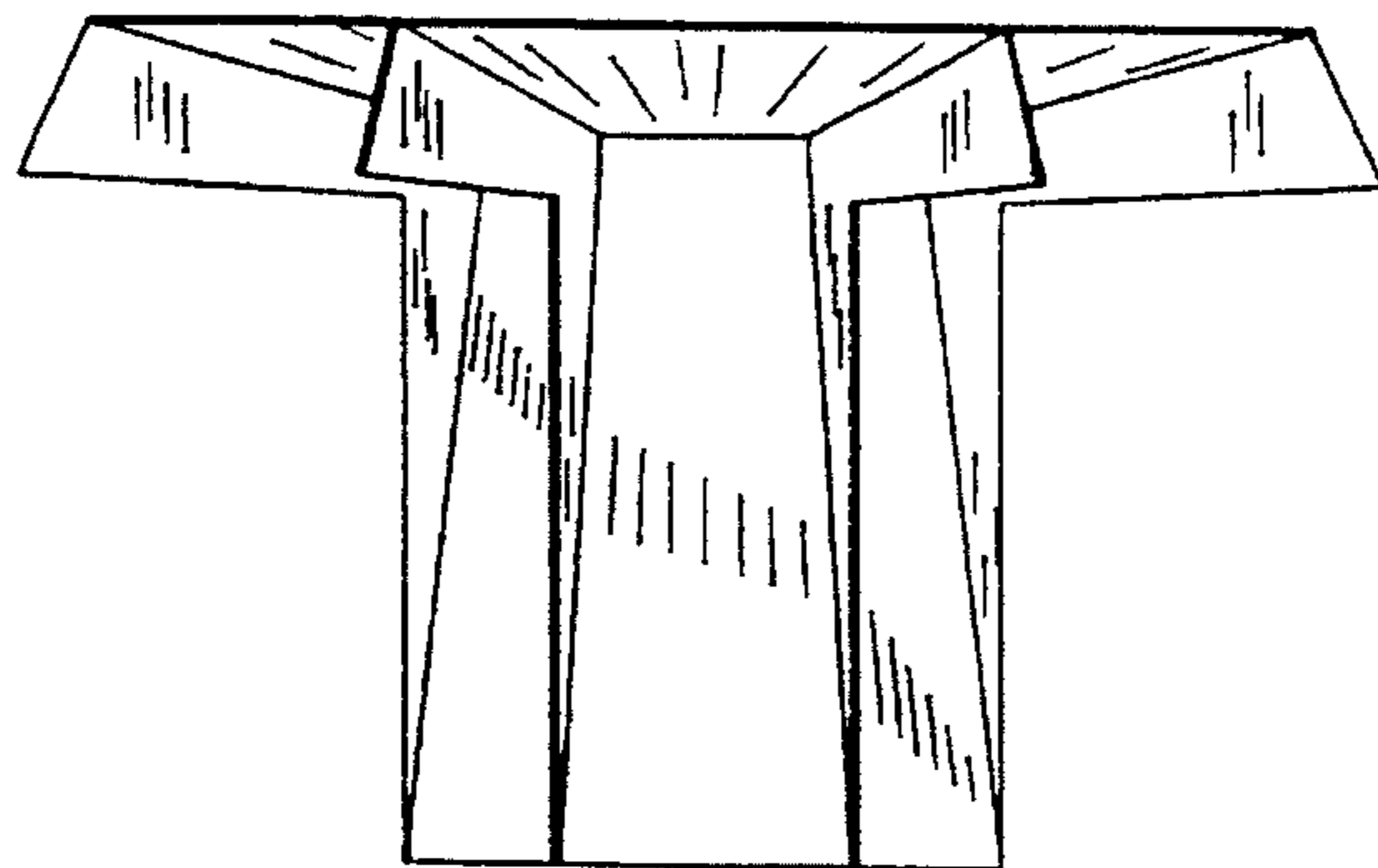

FIG. 54

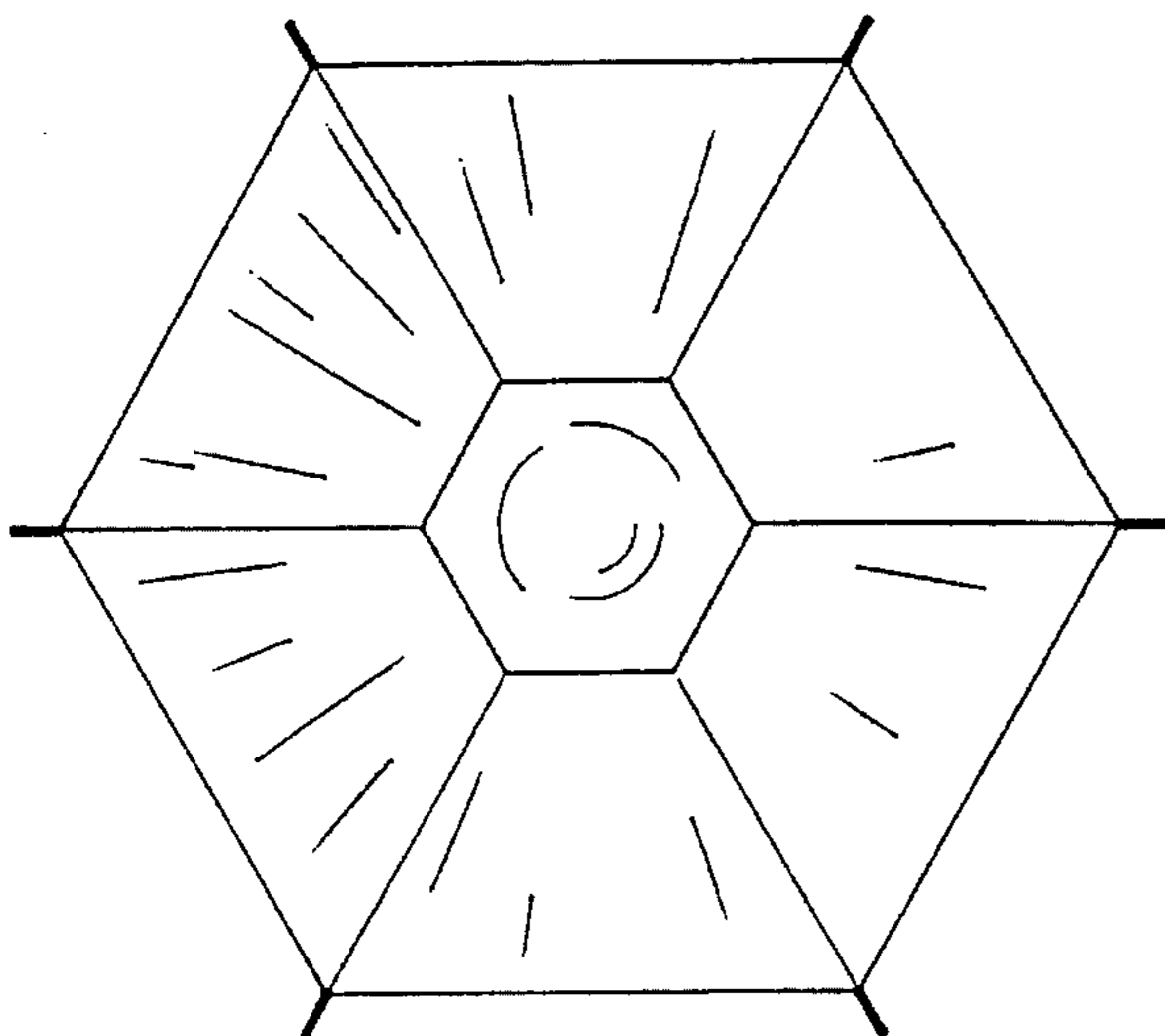

FIG. 55

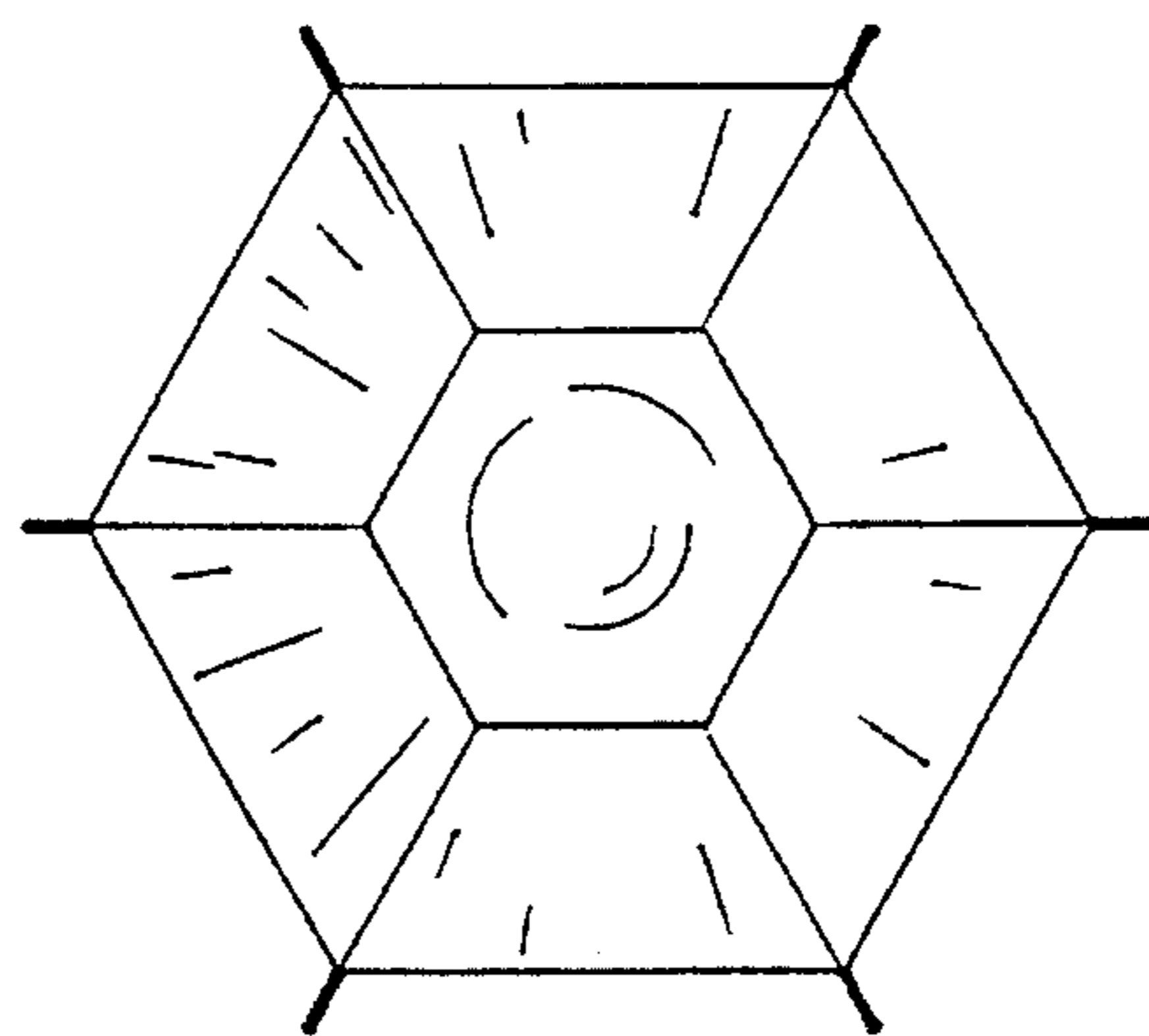

FIG. 56

UNITED STATES PATENT AND TRADEMARK OFFICE
CERTIFICATE OF CORRECTION

PATENT NO. : Des. 369,124
DATED : April 23, 1996
INVENTOR(S) : Weder et al.

It is certified that error appears in the above-identified patent and that said Letters Patent is hereby corrected as shown below:

On the title page, under item [54] insert :

-- OTHER PUBLICATIONS
Exhibit A--Speed Cover® Brochure--The Simple Solution
. . . , ©1989.--

Cover page, Description, Fig. 1, please delete "side".

Signed and Sealed this
Sixteenth Day of July, 1996

Attest:



BRUCE LEHMAN

Attesting Officer

Commissioner of Patents and Trademarks