



US00D369104S

United States Patent [19]

[11] Patent Number: **Des. 369,104**

Heiskell et al.

[45] Date of Patent: ****Apr. 23, 1996**

[54] **COMBINED FRUIT SHIPPING AND STORAGE CONTAINER**

4,993,623	2/1991	Kelly et al.	229/110 X
5,116,290	5/1992	Ross	229/915 X
5,316,207	5/1994	Ross et al.	229/915 X

[76] Inventors: **Ronald E. Heiskell**, 51 Wimbledon La., Tracy, Calif. 95376; **Ezra E. Theys**, 3706 Kenwood Ave., San Mateo, Calif. 94403

Primary Examiner—Ted Shooman
Assistant Examiner—Nanda Bondade
Attorney, Agent, or Firm—Burns, Doane, Swecker & Mathis

[**] Term: **14 Years**

[57] **CLAIM**

[21] Appl. No.: **30,174**

The ornamental design for a combined fruit shipping and storage container, as shown and described.

[22] Filed: **Oct. 21, 1994**

DESCRIPTION

[52] U.S. Cl. **D9/431; D9/423**

[58] **Field of Search** D9/346, 430-433, D9/420-423; 206/600; 220/1.5, 337, 339; 229/108-110, 120.08, 122, 125.125, 915, 916, 919

FIG. 1 is a perspective view of a combined fruit shipping and storage container with lid flaps closed showing our new design;

FIG. 2 is a right side elevational view thereof, the left side being identical;

FIG. 3 is a front elevational view thereof, the rear view being identical;

FIG. 4 is a top plan view thereof;

FIG. 5 is a bottom plan view thereof; and,

FIG. 6 is a perspective view thereof with the lid flaps open.

[56] **References Cited**

U.S. PATENT DOCUMENTS

D. 348,607	7/1994	Young	D9/432 X
3,915,372	10/1975	Crane	229/125 X
4,884,739	12/1989	Nederveld	229/109

1 Claim, 6 Drawing Sheets

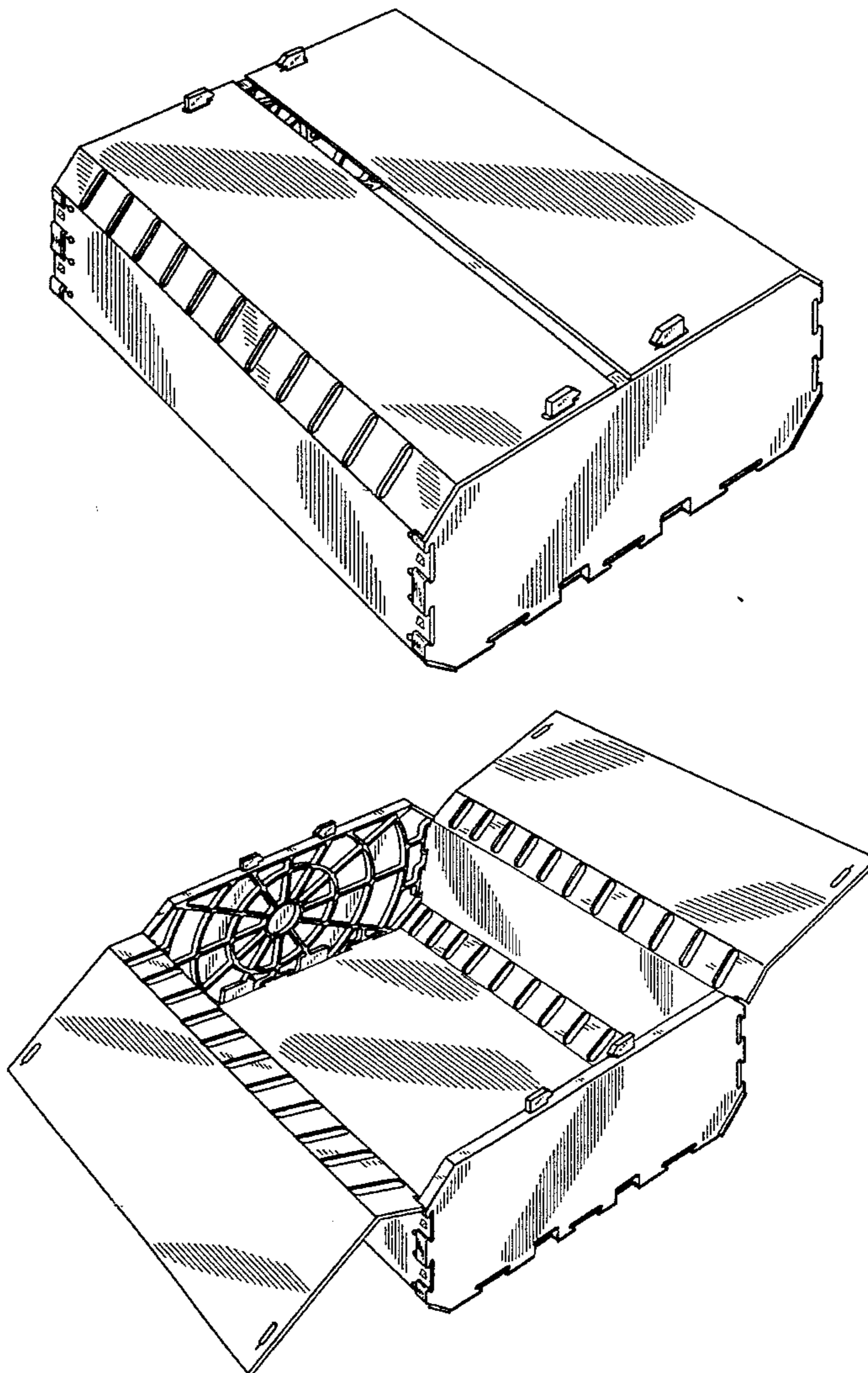

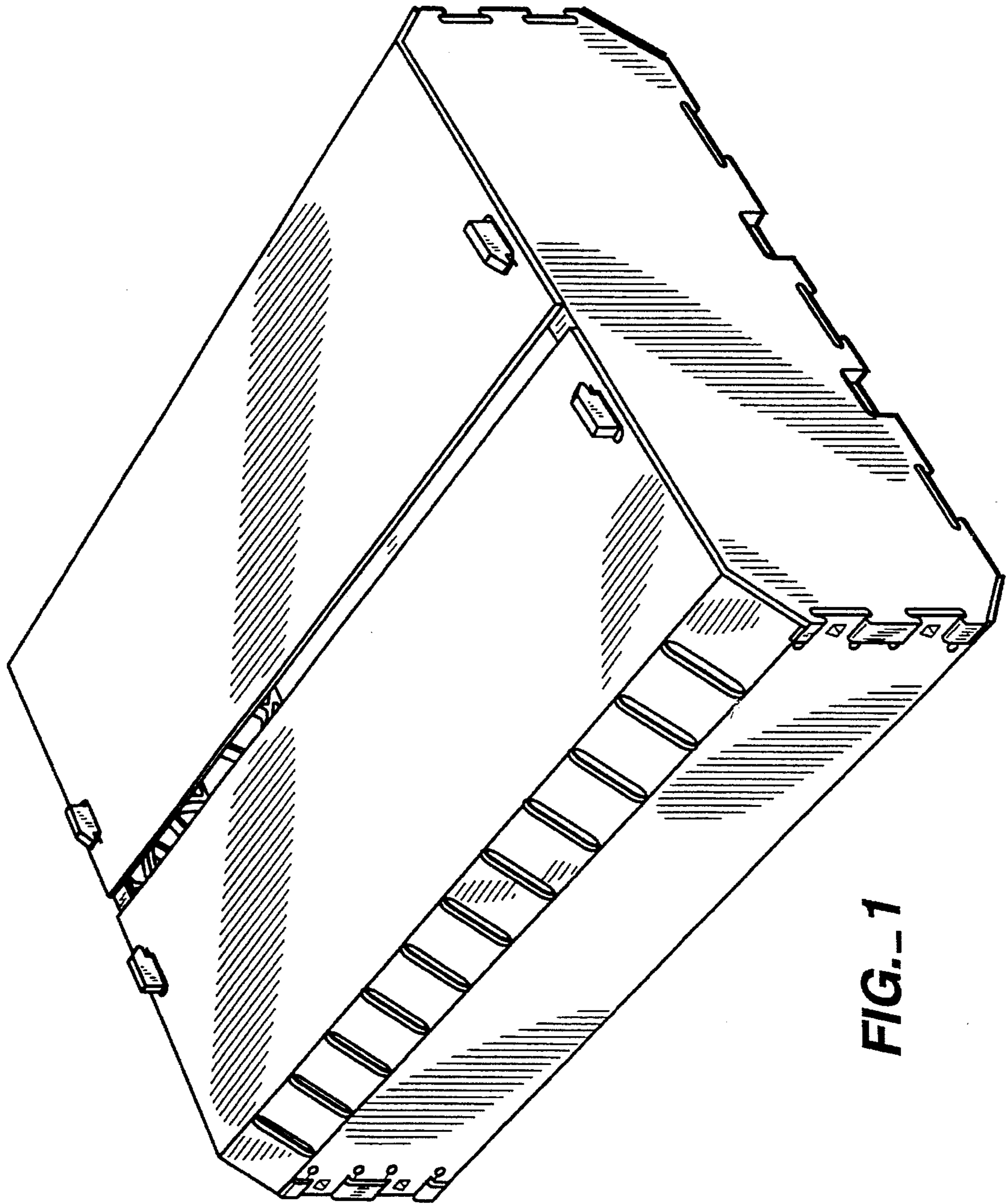

FIG.- 1

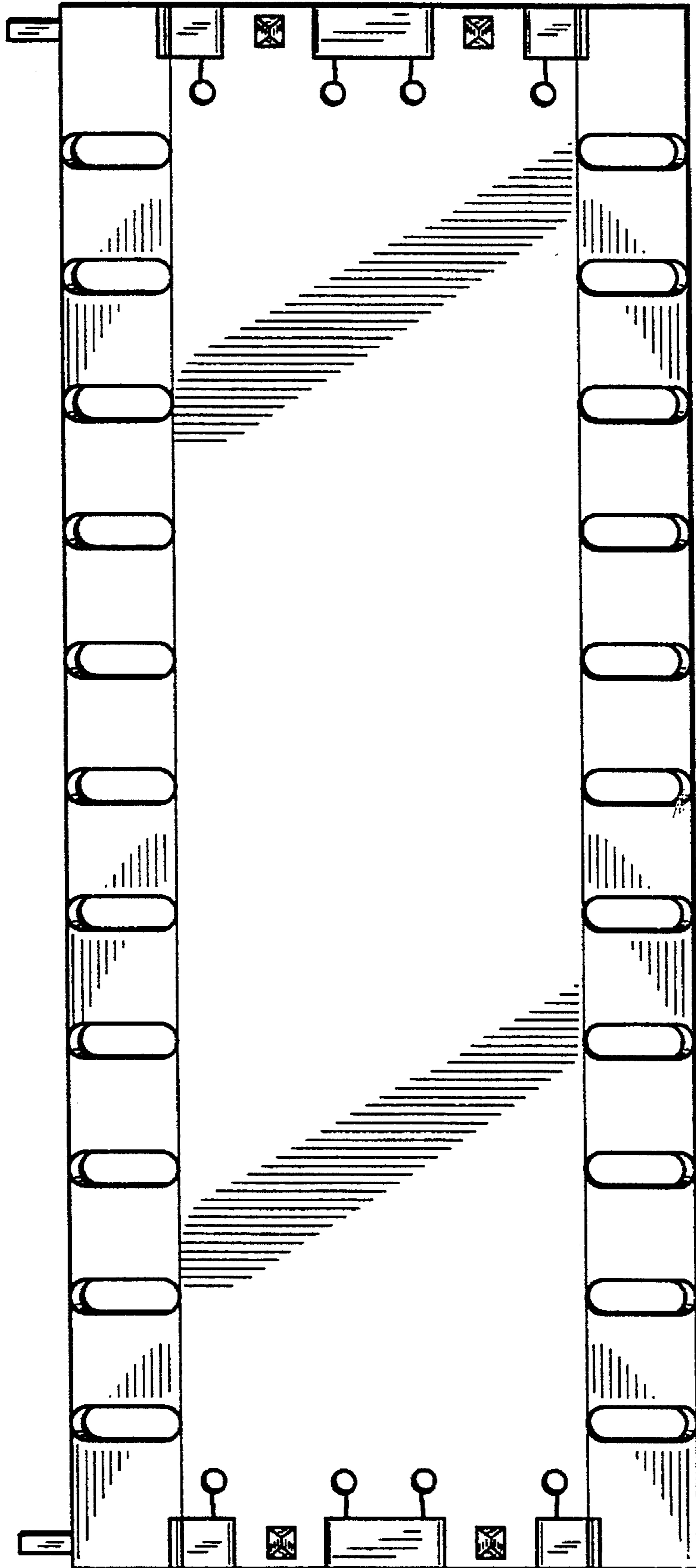

FIG.-2

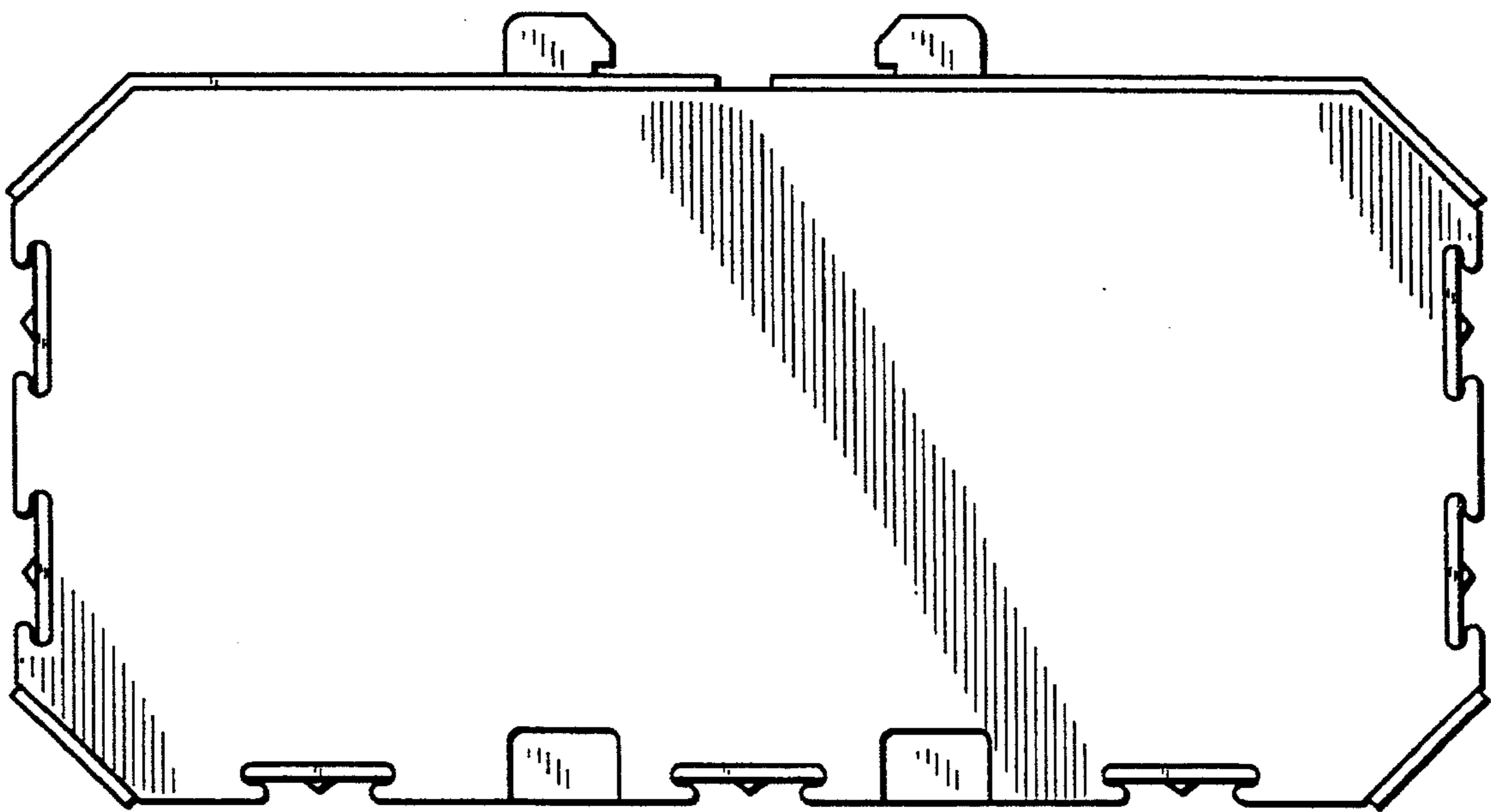

FIG. 3

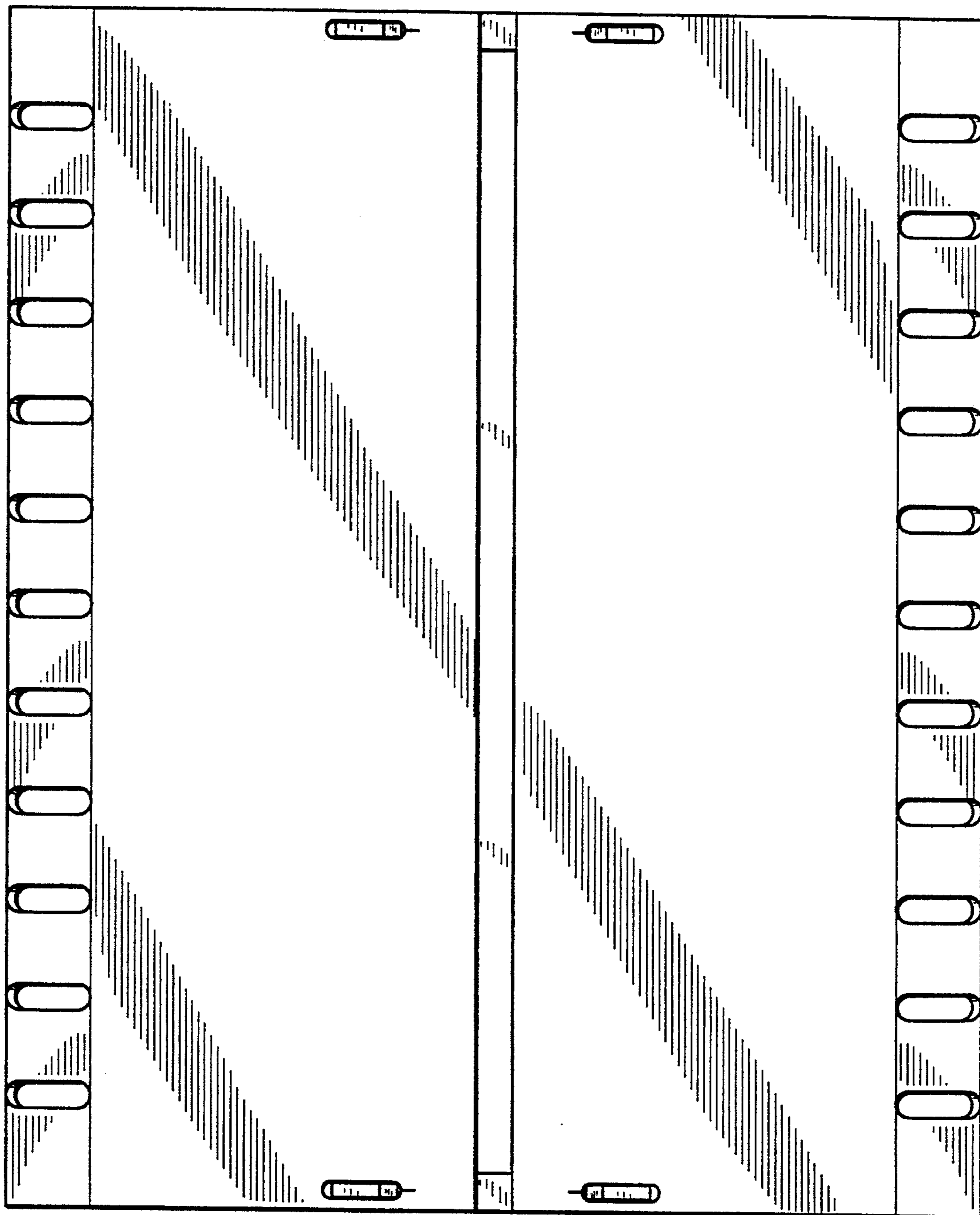

FIG. 4

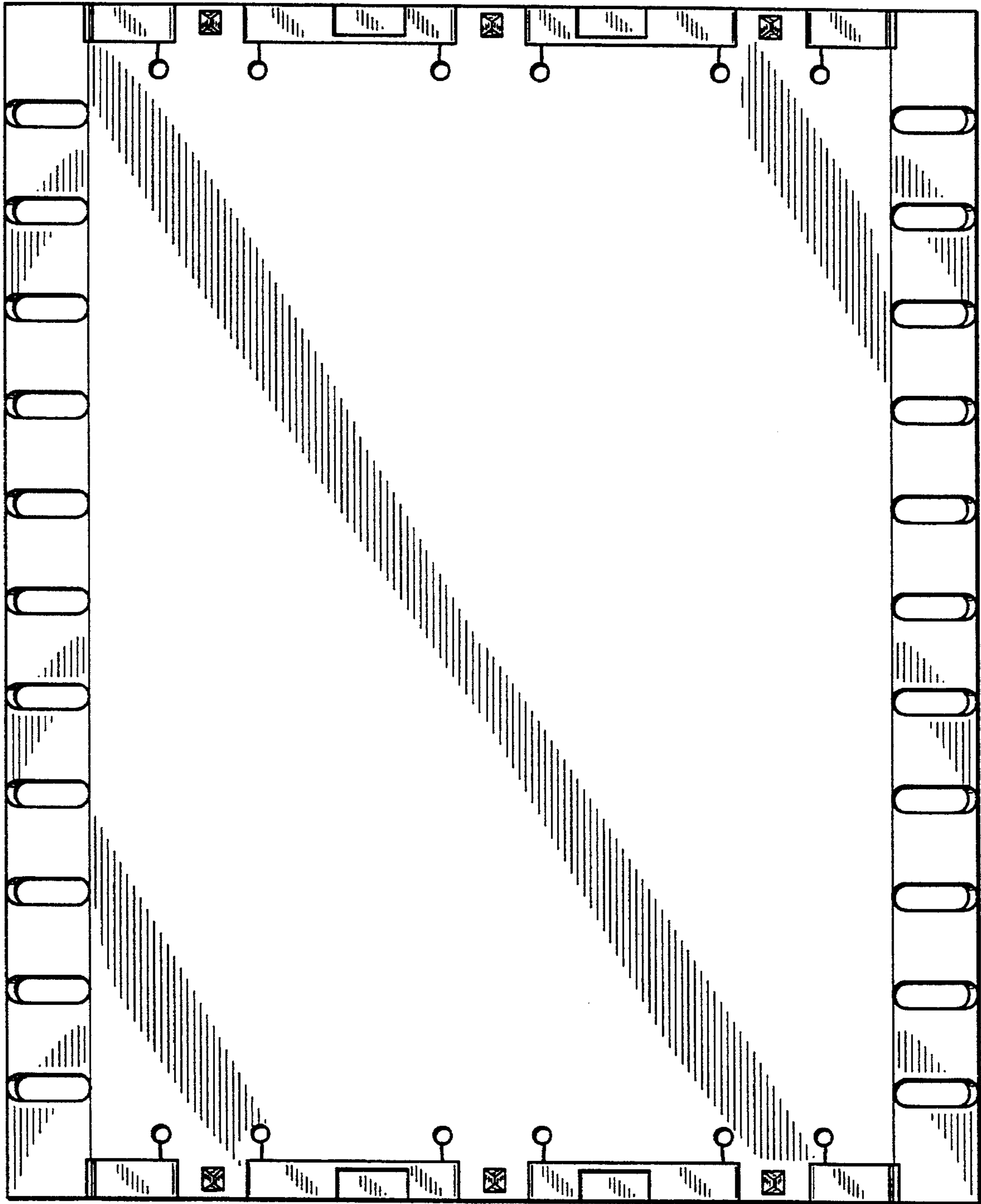

FIG. 5

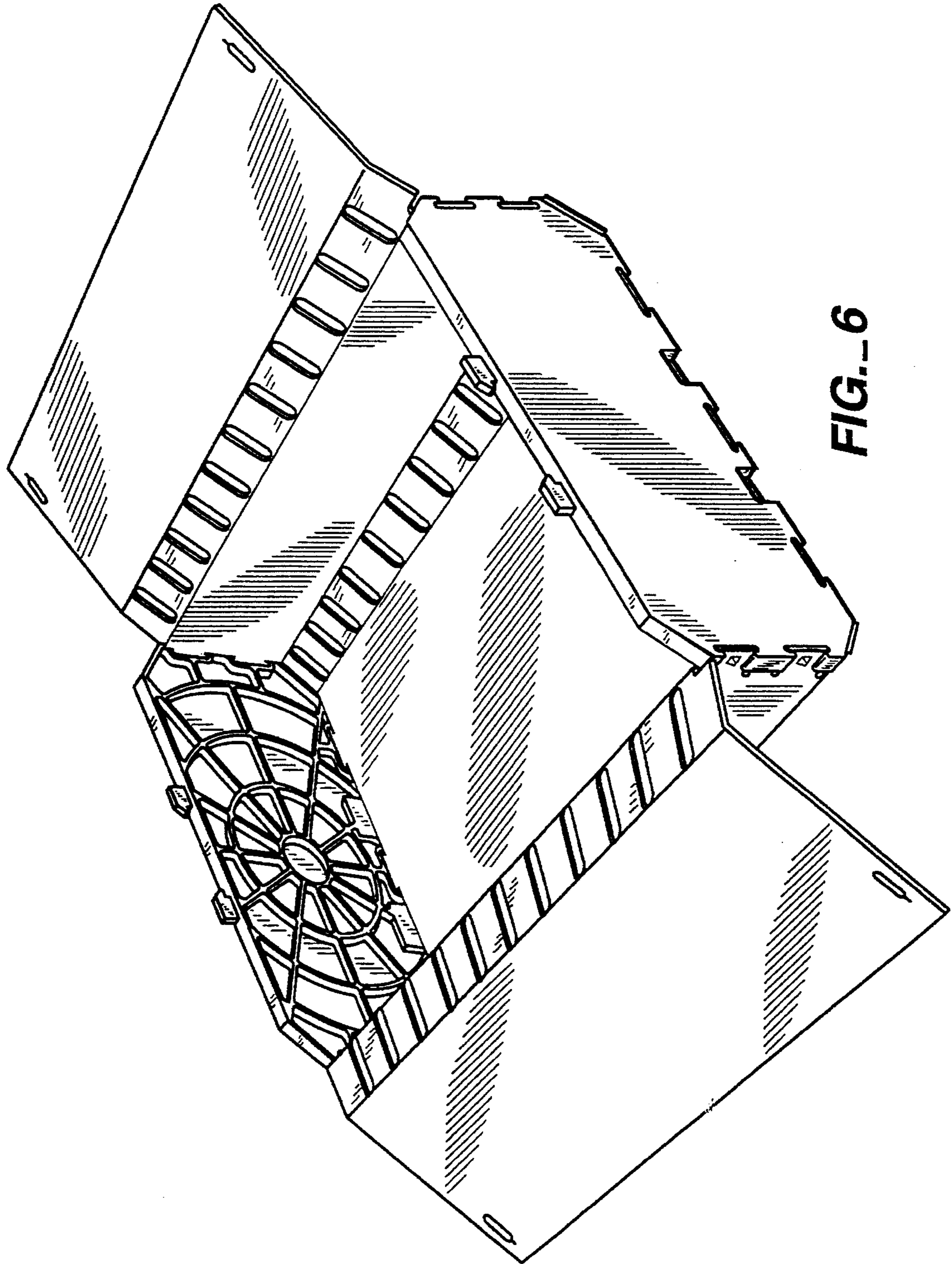

FIG.-6