



US00D369086S

**United States Patent** [19]  
**Bergen**

[11] **Patent Number: Des. 369,086**

[45] **Date of Patent: \*\*Apr. 23, 1996**

[54] **LEVER DOORKNOB ADAPTOR**

D. 289,369 1/1987 Foshee ..... D8/308  
4,648,643 3/1987 Bettger ..... 292/347

[75] Inventor: **Rodney F. Bergen**, Moorhead, Minn.

*Primary Examiner*—B. J. Bullock  
*Attorney, Agent, or Firm*—Merchant, Gould, Smith, Edell,  
Welter & Schmidt

[73] Assignee: **Extend Incorporated**, Moorhead,  
Minn.

[\*\*] Term: **14 Years**

[57] **CLAIM**

[21] Appl. No.: **32,191**

The ornamental design for a lever doorknob adaptor, as shown and described.

[22] Filed: **Nov. 30, 1994**

**DESCRIPTION**

**Related U.S. Application Data**

[63] Continuation of Ser. No. 6,372, Mar. 25, 1993, abandoned.

FIG. 1 is a front, top and right perspective view of a lever doorknob adaptor showing my new design, the broken line showing of a doorknob being for illustrative purposes only; FIG. 2 is a front elevational view thereof; FIG. 3 is a rear elevational view thereof; FIG. 4 is a bottom plan view thereof; FIG. 5 is a top plan view thereof; FIG. 6 is a right side elevational view thereof; and, FIG. 7 is a left side elevational view thereof.

[52] **U.S. Cl.** ..... **D8/308**; D8/321

[58] **Field of Search** ..... D8/308, 321; 16/110 R, 16/114 R, 121; 292/336.3, 347, 288, DIG. 2

[56] **References Cited**

**U.S. PATENT DOCUMENTS**

D. 268,984 5/1983 Bergen ..... D8/308

**1 Claim, 2 Drawing Sheets**

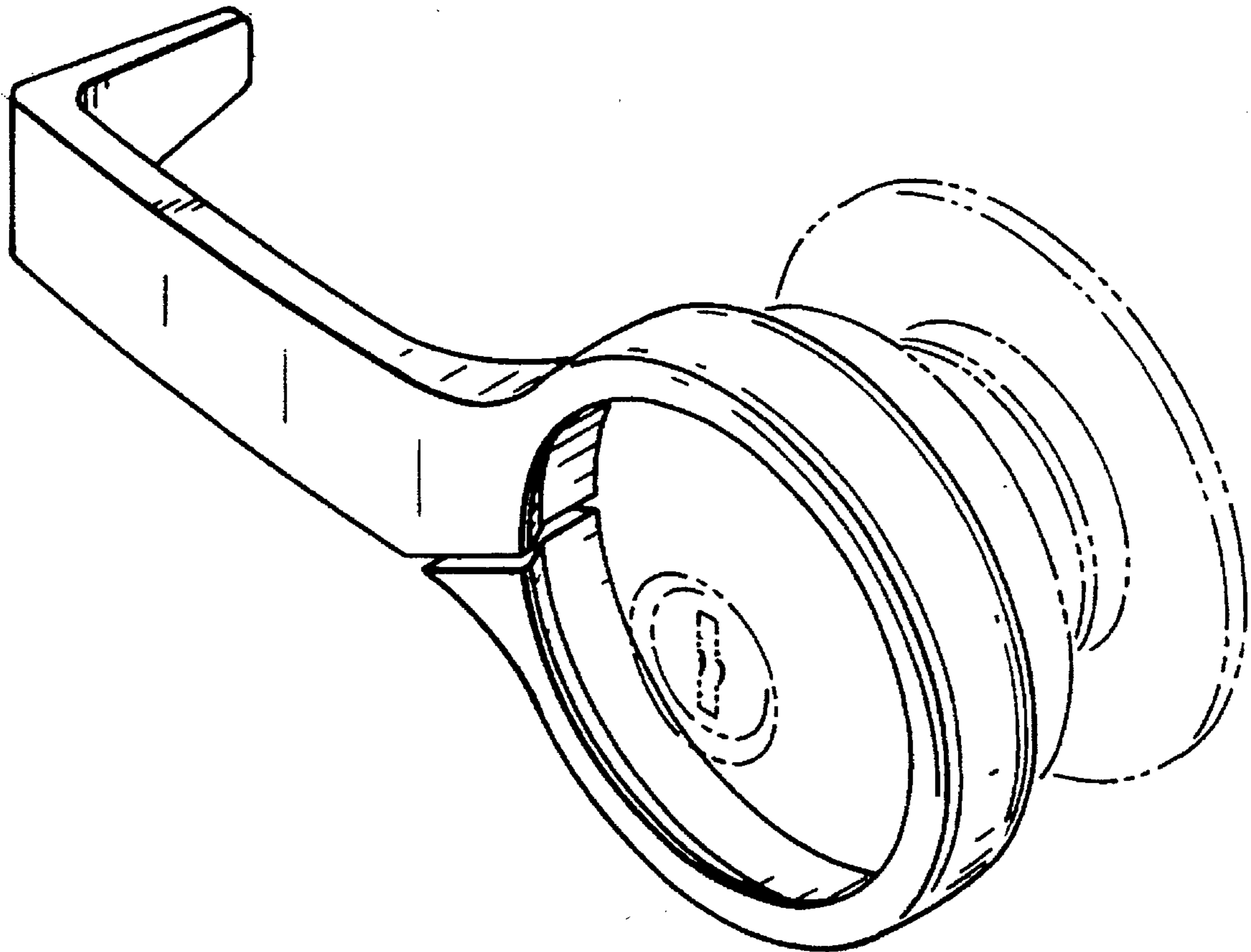

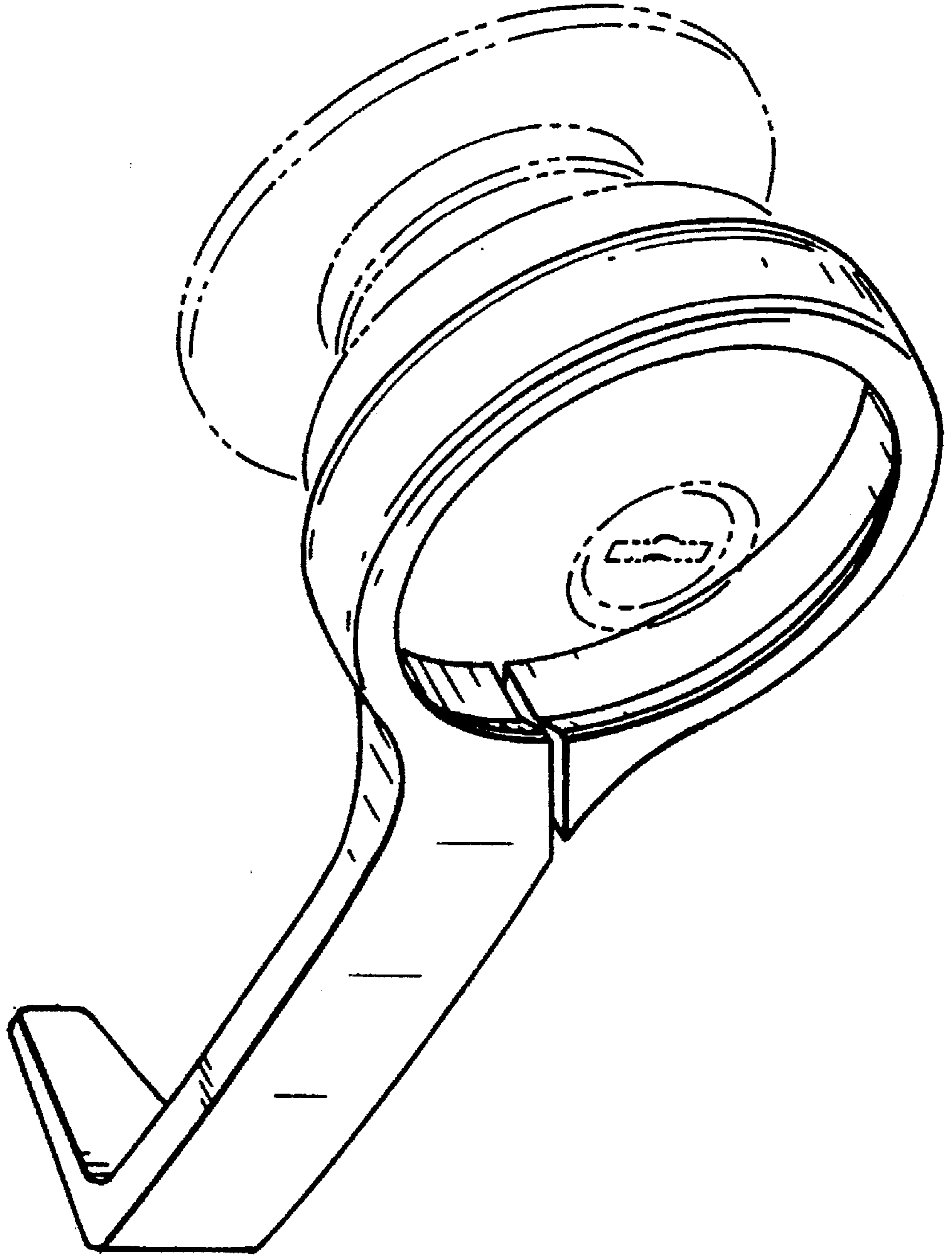

FIG. 1

FIG. 2

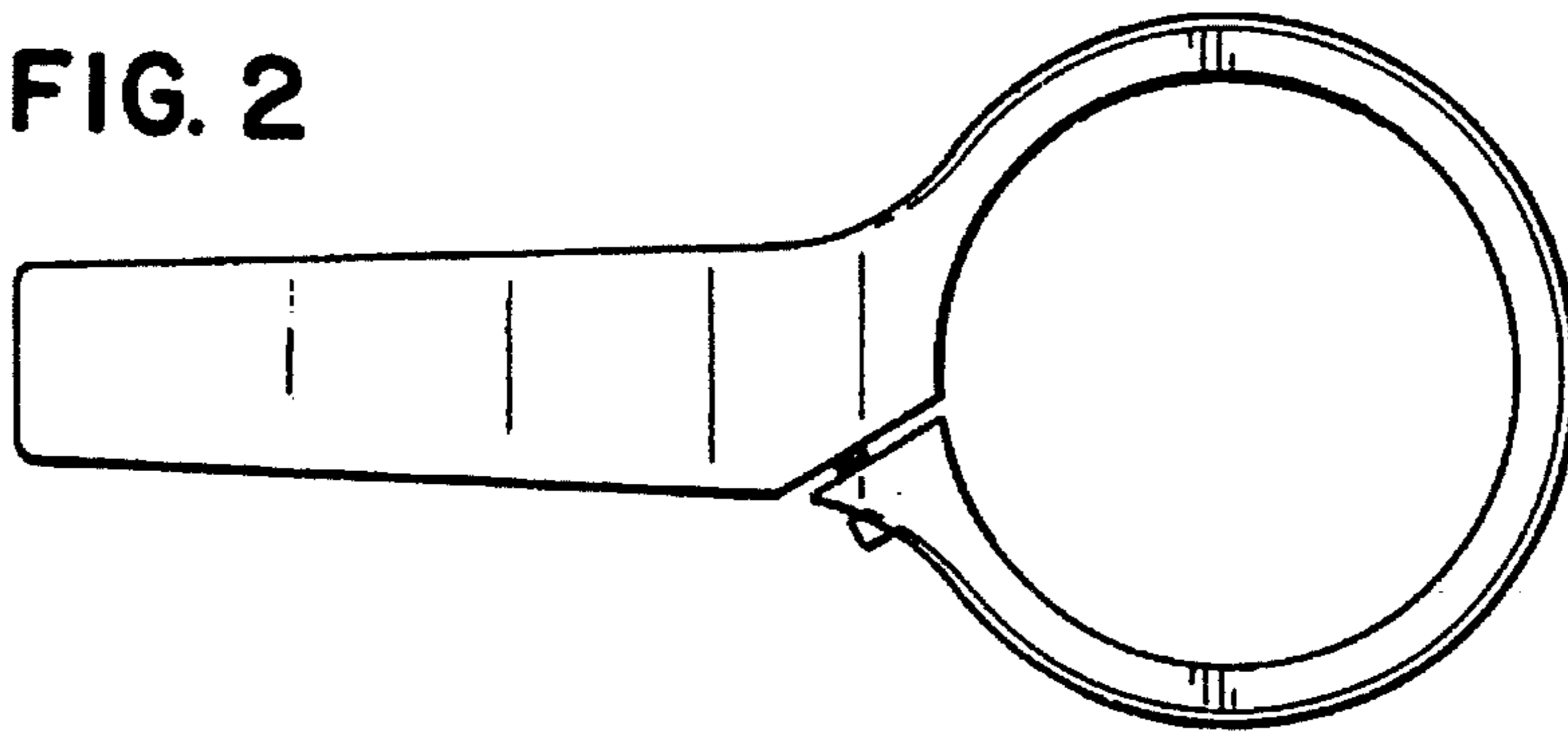

FIG. 3

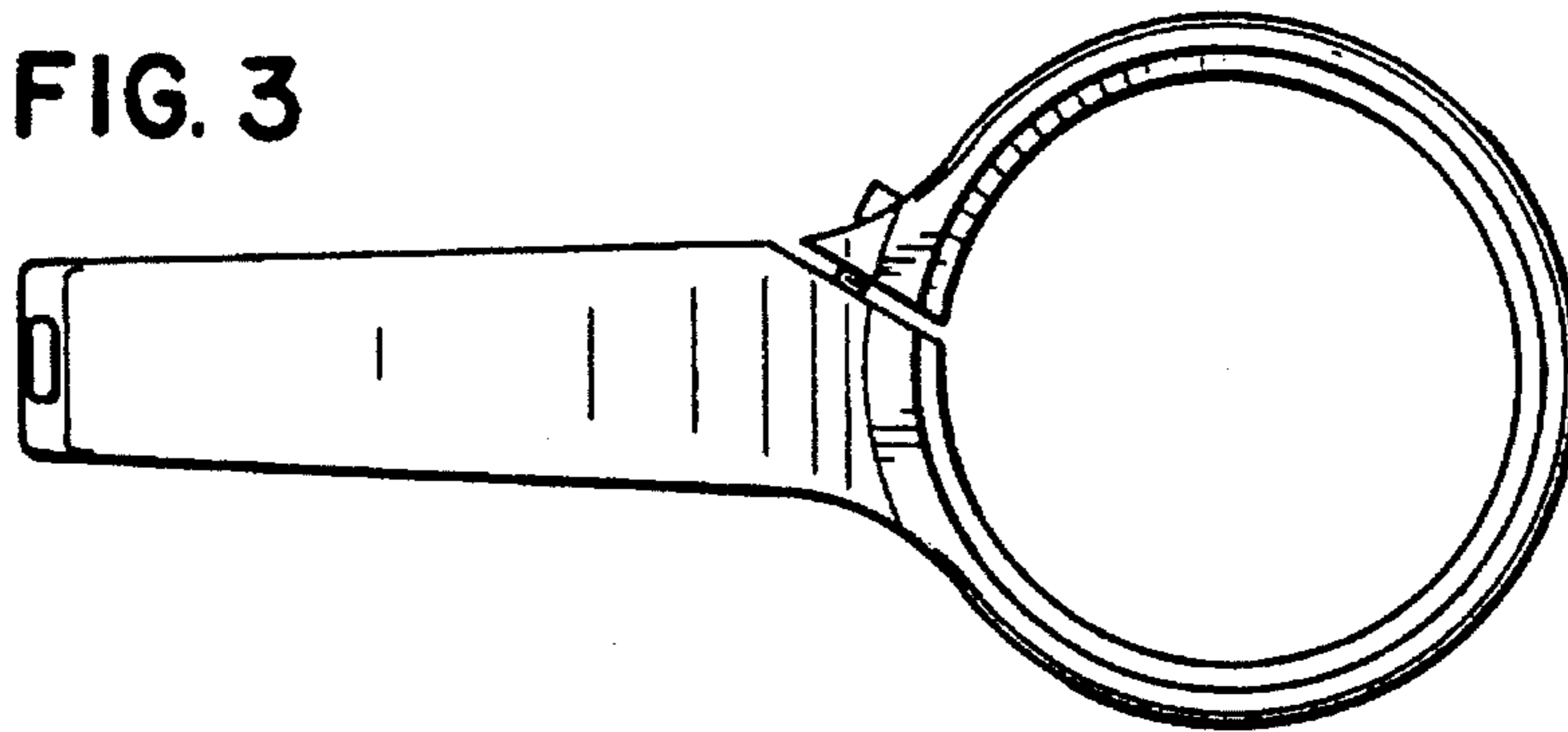

FIG. 4

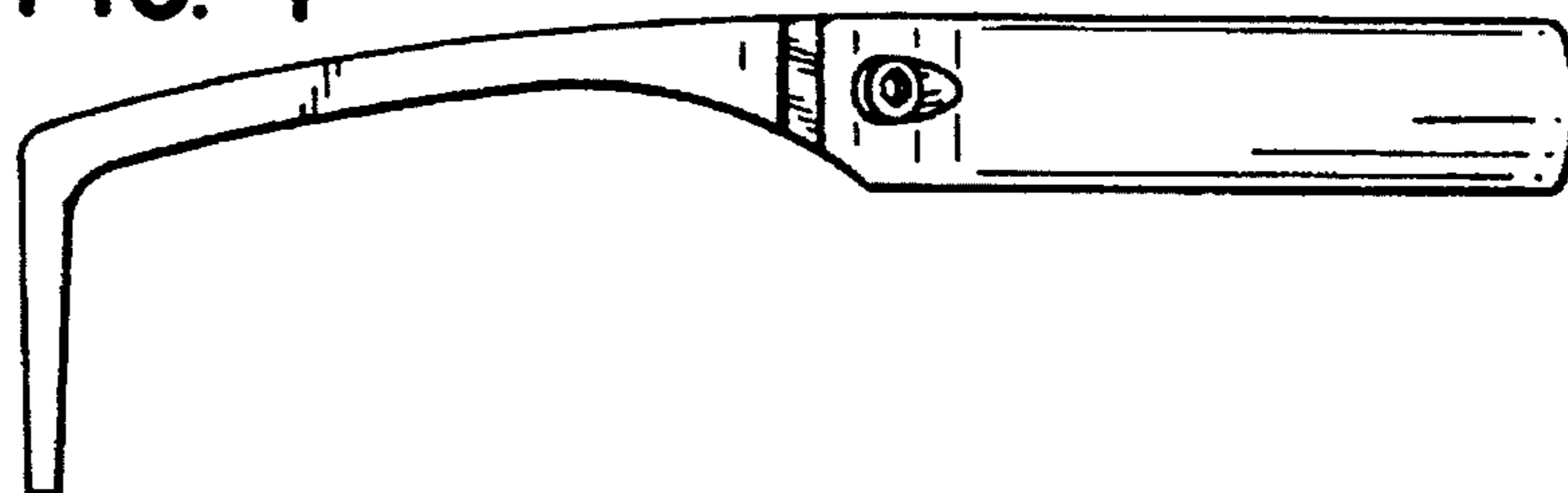

FIG. 5

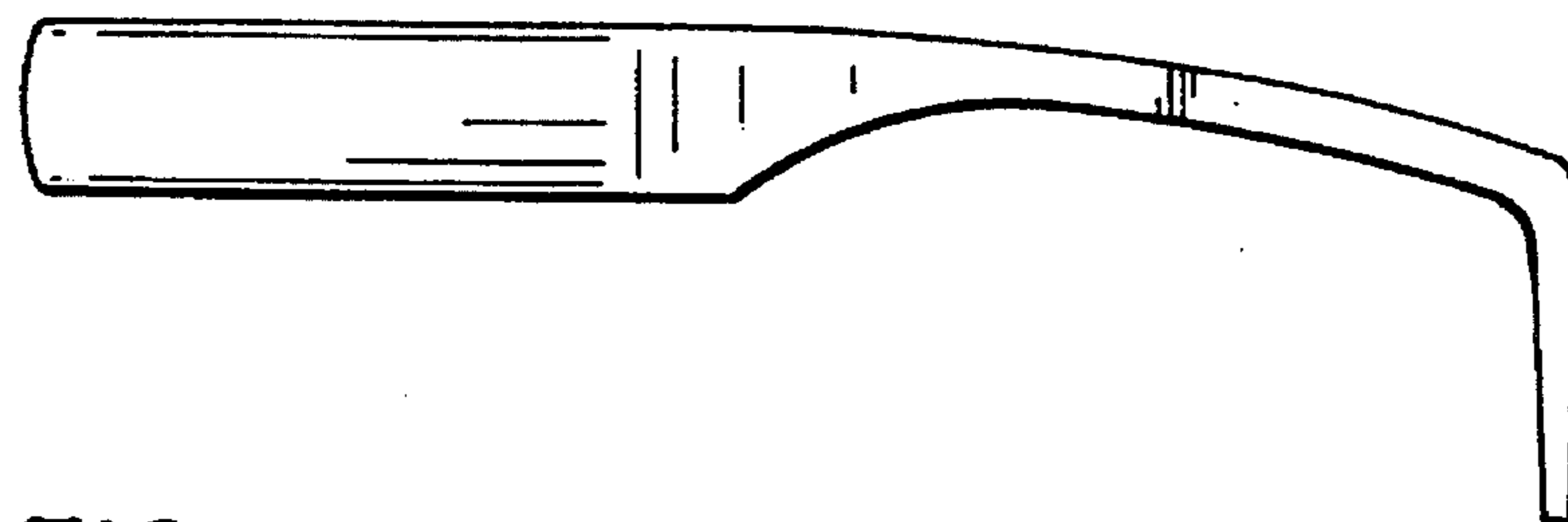

FIG. 6

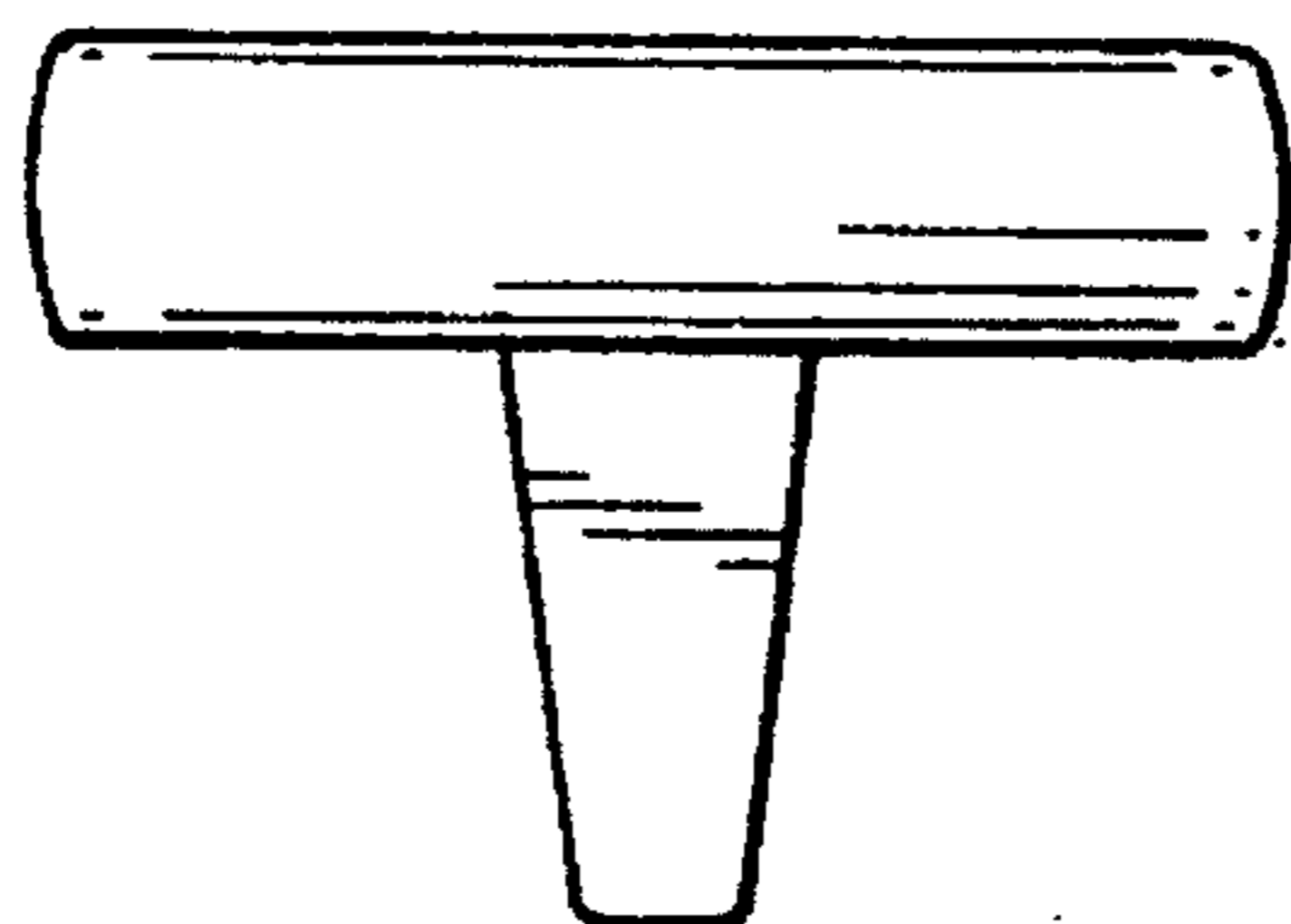

FIG. 7

