



US00D369063S

United States Patent [19]
Meisner

[11] **Patent Number: Des. 369,063**
[45] **Date of Patent: **Apr. 23, 1996**

[54] **AUTO MUG**
[75] **Inventor: Edward H. Meisner, Short Hills, N.J.**
[73] **Assignee: Eagle Affiliates, Inc., Harrison, N.J.**
[**] **Term: 14 Years**

D. 325,848 5/1992 Embree D7/533
D. 339,029 9/1993 Schaeppi .
D. 343,991 2/1994 Schaeppi .
D. 346,933 5/1994 Denny et al. D7/536
3,349,956 10/1967 Wanderer D7/511 X
5,312,014 5/1994 Hamlin 215/388 X
5,344,040 9/1994 Schaeppi .

[21] **Appl. No.: 32,754**
[22] **Filed: Dec. 27, 1994**
[52] **U.S. Cl. D7/533; D7/536; D7/511**
[58] **Field of Search D7/619, 622, 507, D7/509, 510, 511, 513, 512, 514, 515, 516, 523, 524, 531, 532, 533, 534, 535, 536; 215/396, 398, 388; 220/713, 711**

Primary Examiner—M. N. Pandozzi
Attorney, Agent, or Firm—Caesar, Rivise, Bernstein, Cohen & Pokotilow, Ltd.

[57] **CLAIM**

The ornamental design for an auto mug, as shown and described.

DESCRIPTION

FIG. 1 is an isometric view of the auto mug of the present invention;
FIG. 2 is a left side view of the auto mug of FIG. 1;
FIG. 3 is a rear view of the auto mug of FIG. 1;
FIG. 4 is a right side view of the auto mug of FIG. 1;
FIG. 5 is a front view of the auto mug of FIG. 1;
FIG. 6 is a top view of the auto mug of FIG. 1; and,
FIG. 7 is a bottom view of the auto mug of FIG. 1.

[56] **References Cited**

U.S. PATENT DOCUMENTS

D. 161,712 1/1951 Roop D7/536
D. 204,783 5/1966 Johnson D7/531
D. 274,695 7/1984 Kennedy D7/511 X
D. 285,634 9/1986 Zieff et al. D7/536
D. 286,725 11/1986 Zieff D7/531
D. 293,293 12/1987 Isles D7/536
D. 321,457 11/1991 Kahl D7/510

1 Claim, 4 Drawing Sheets

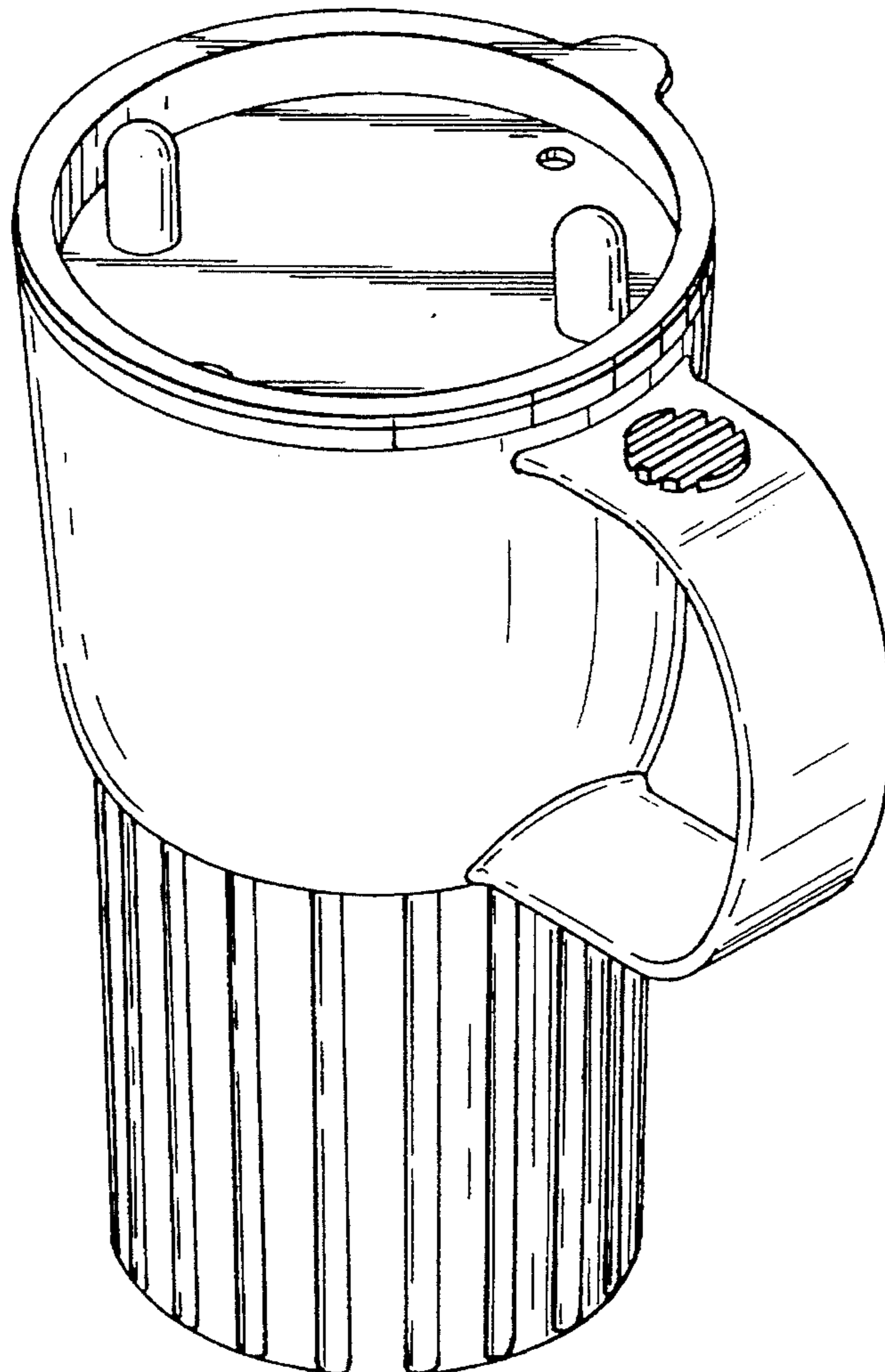
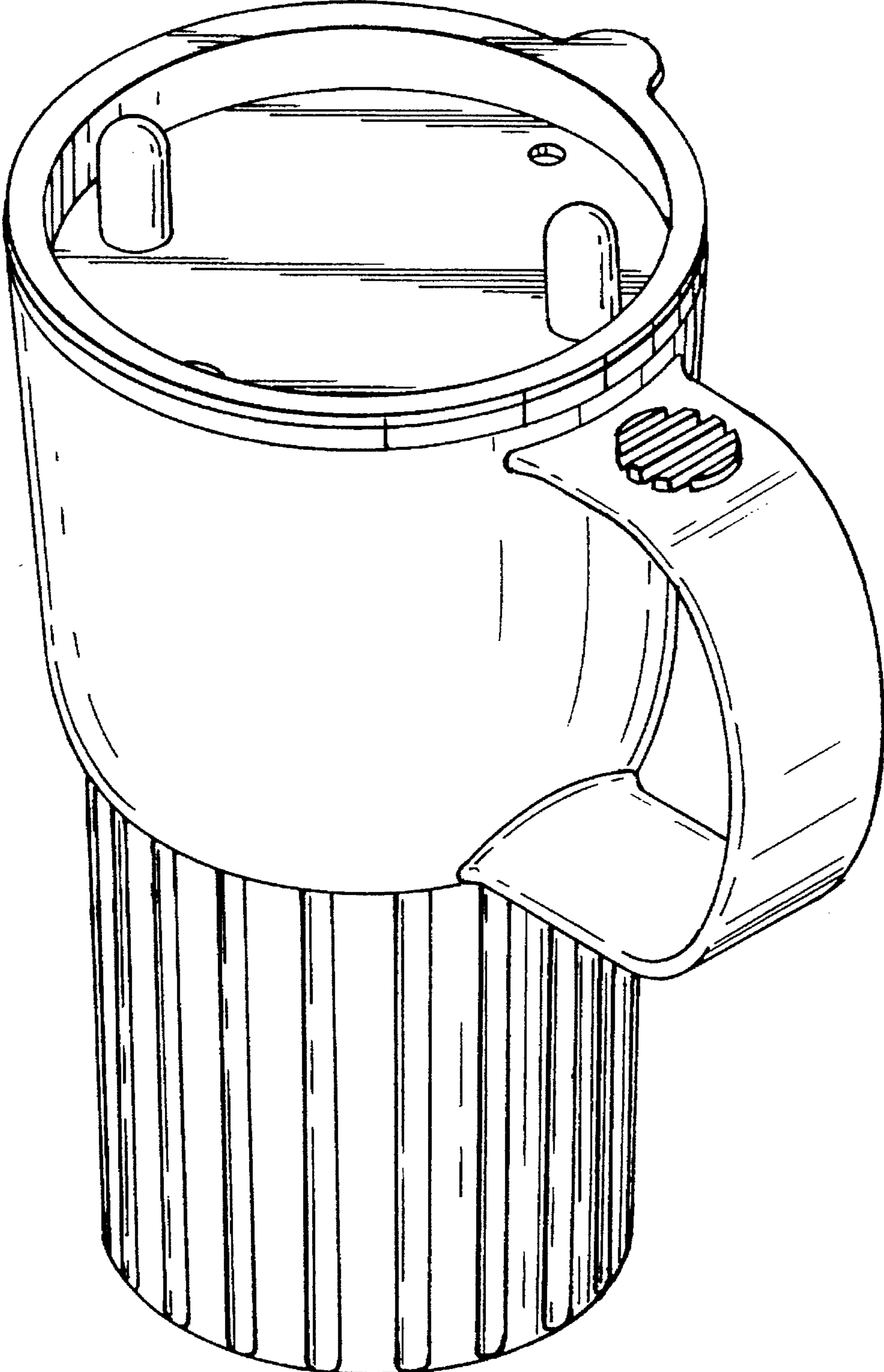

FIG. 1



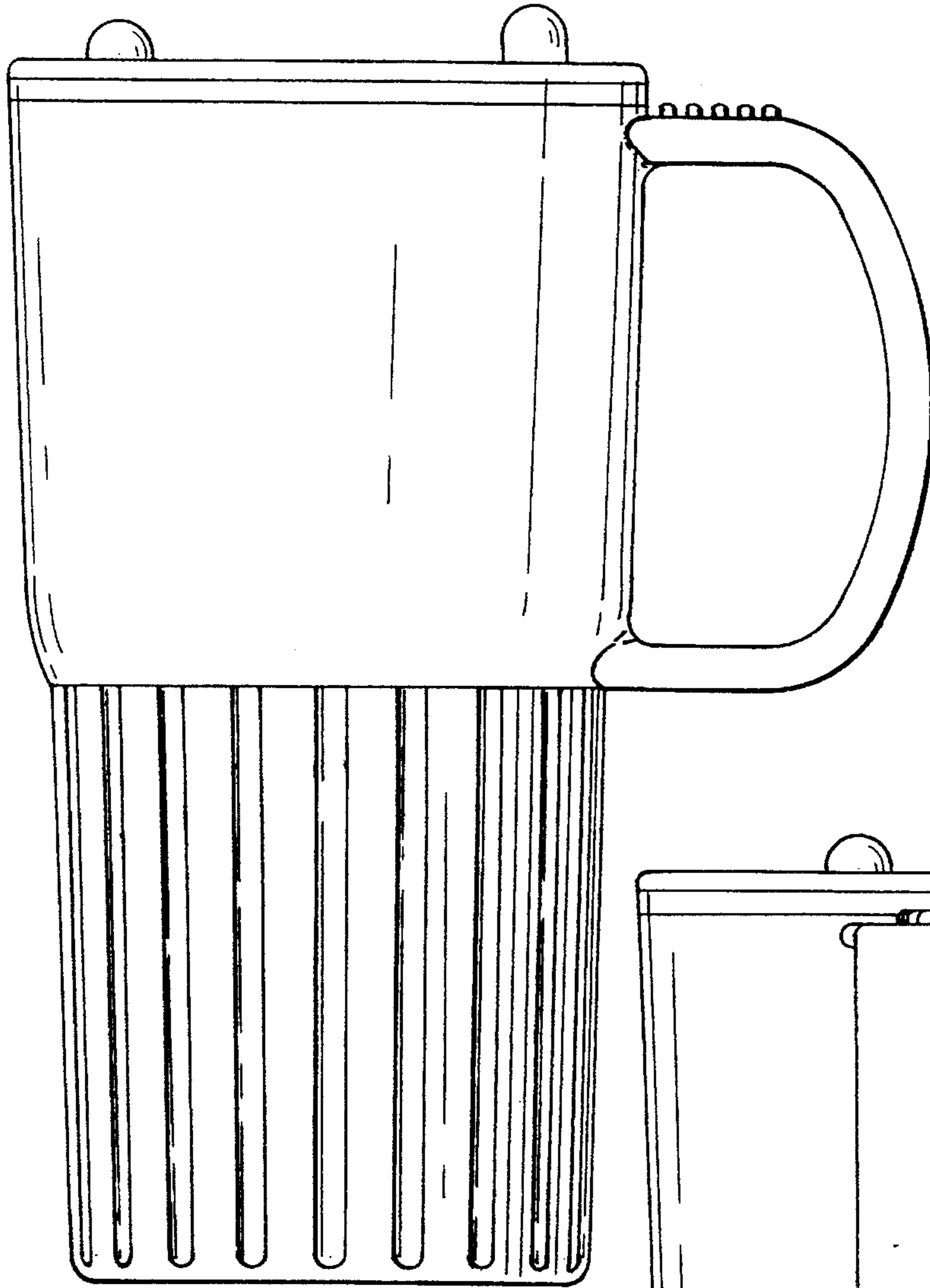

FIG. 2

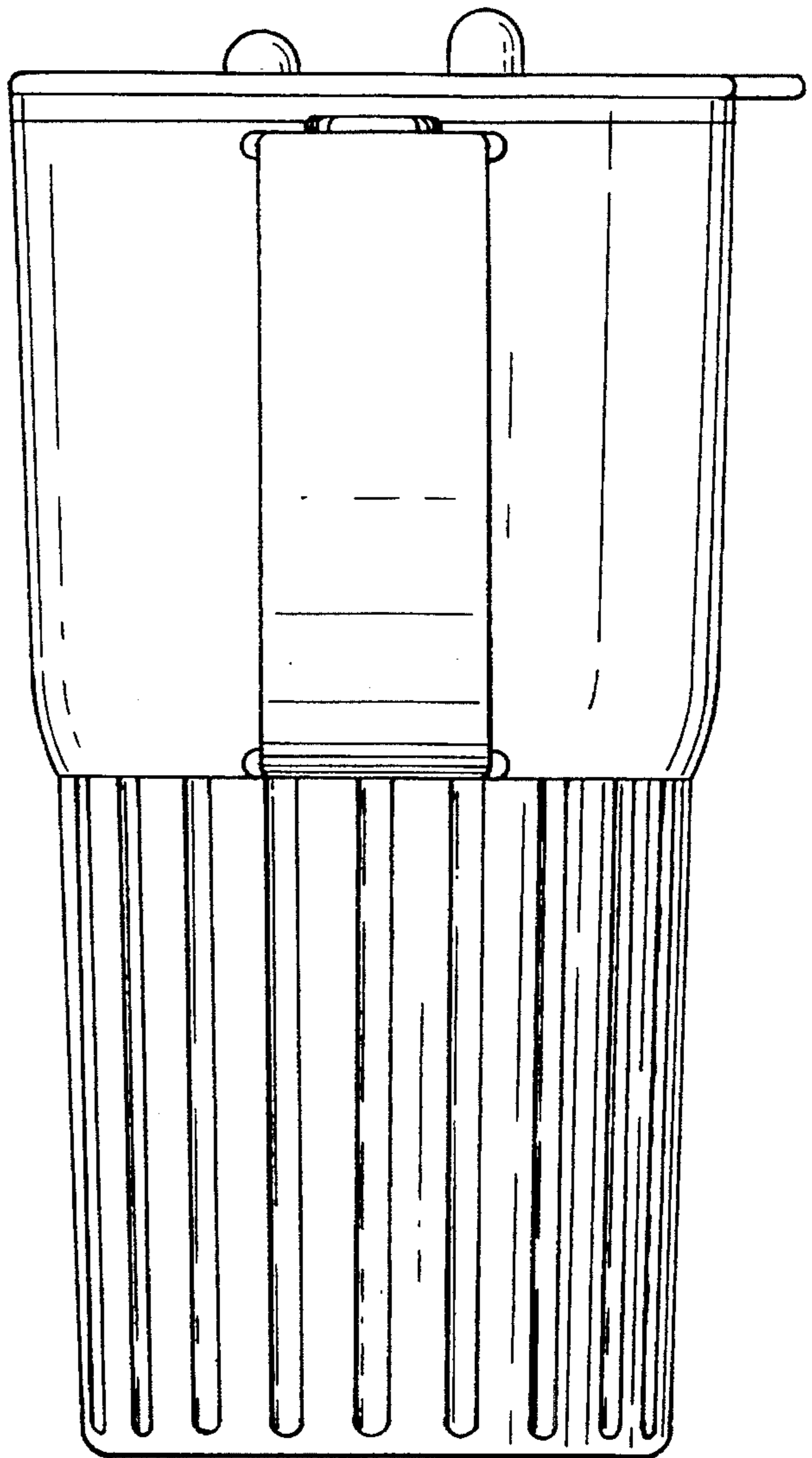

FIG. 3

FIG. 4

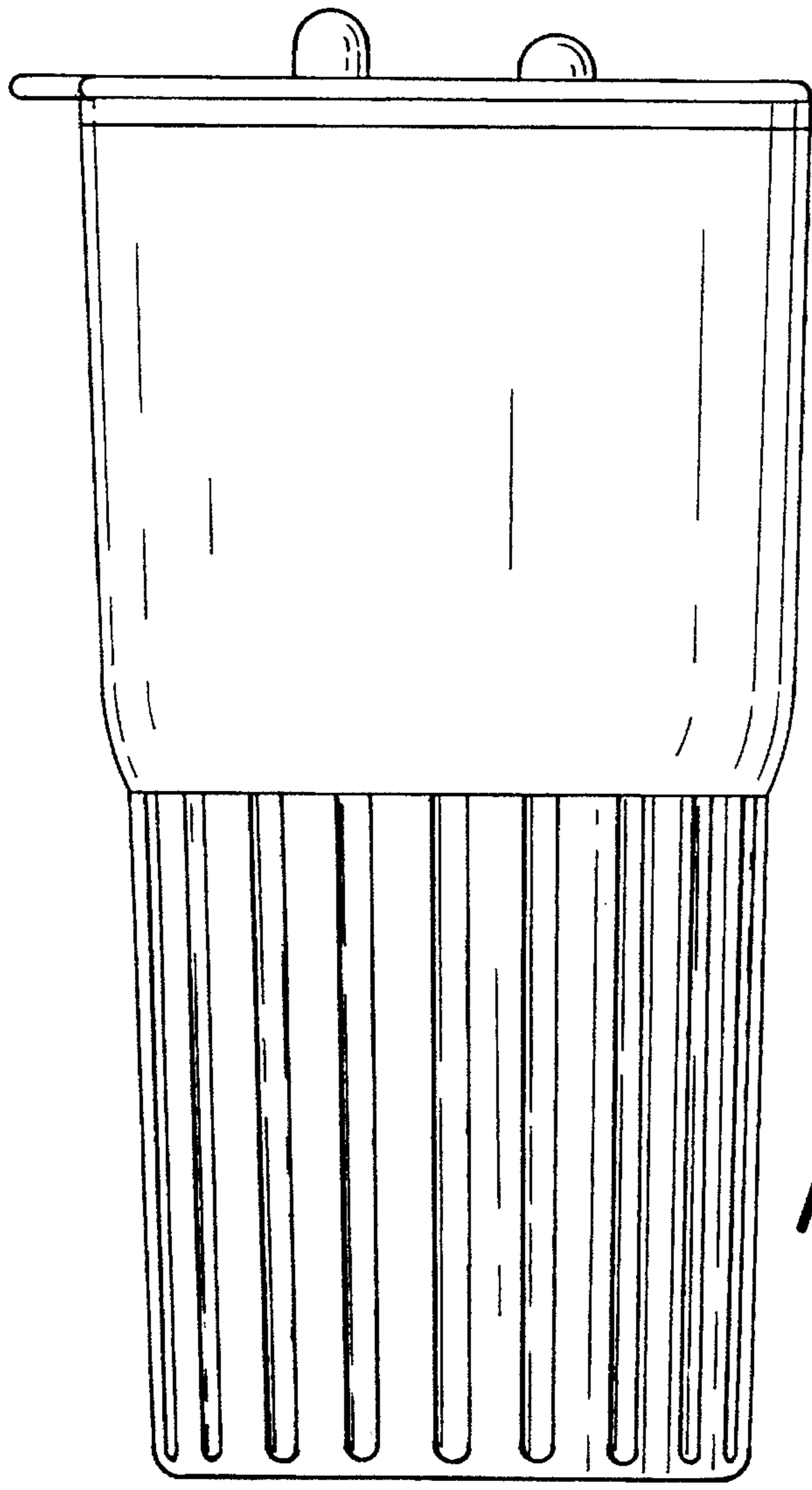
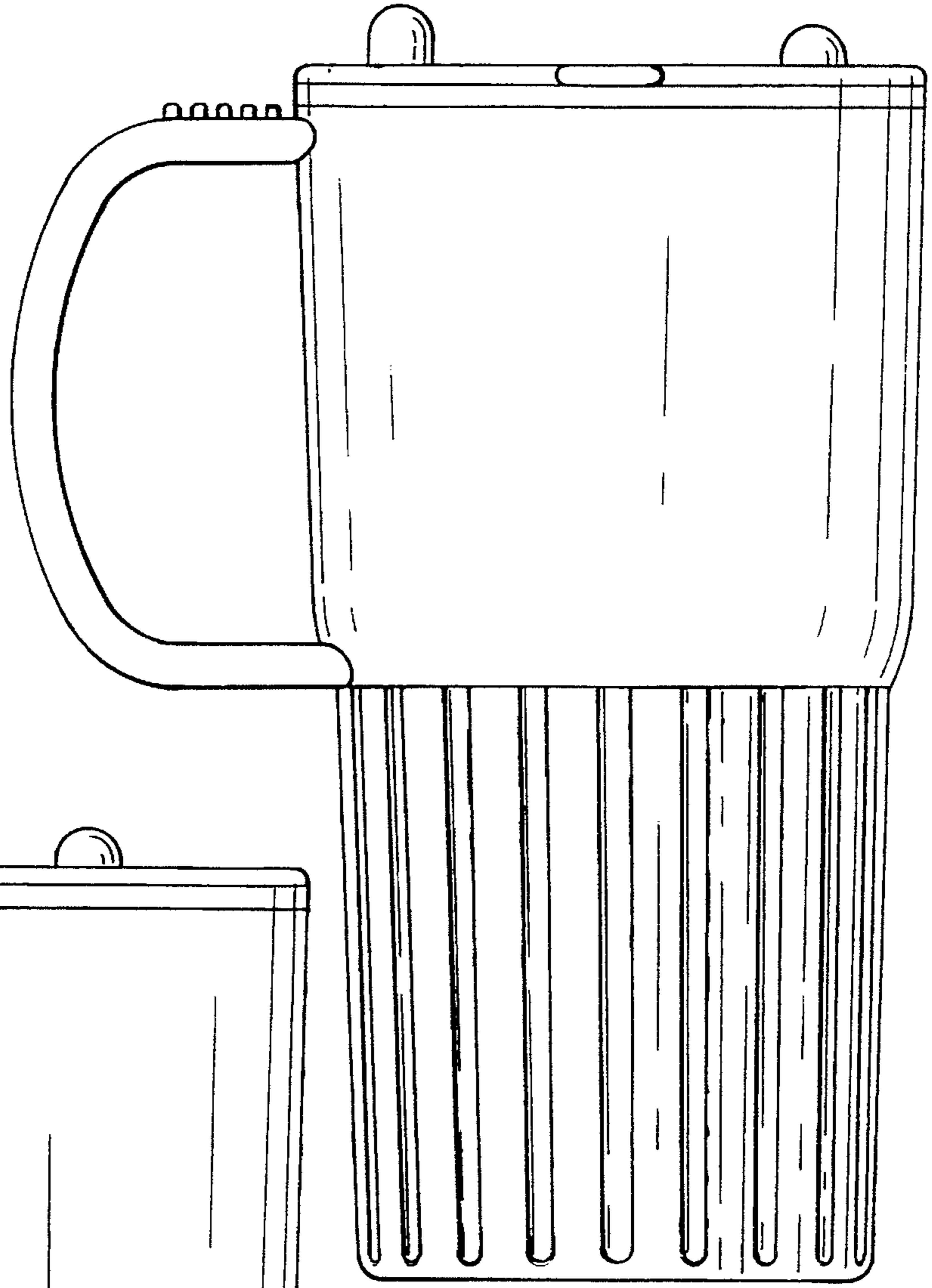

FIG. 5

FIG.6

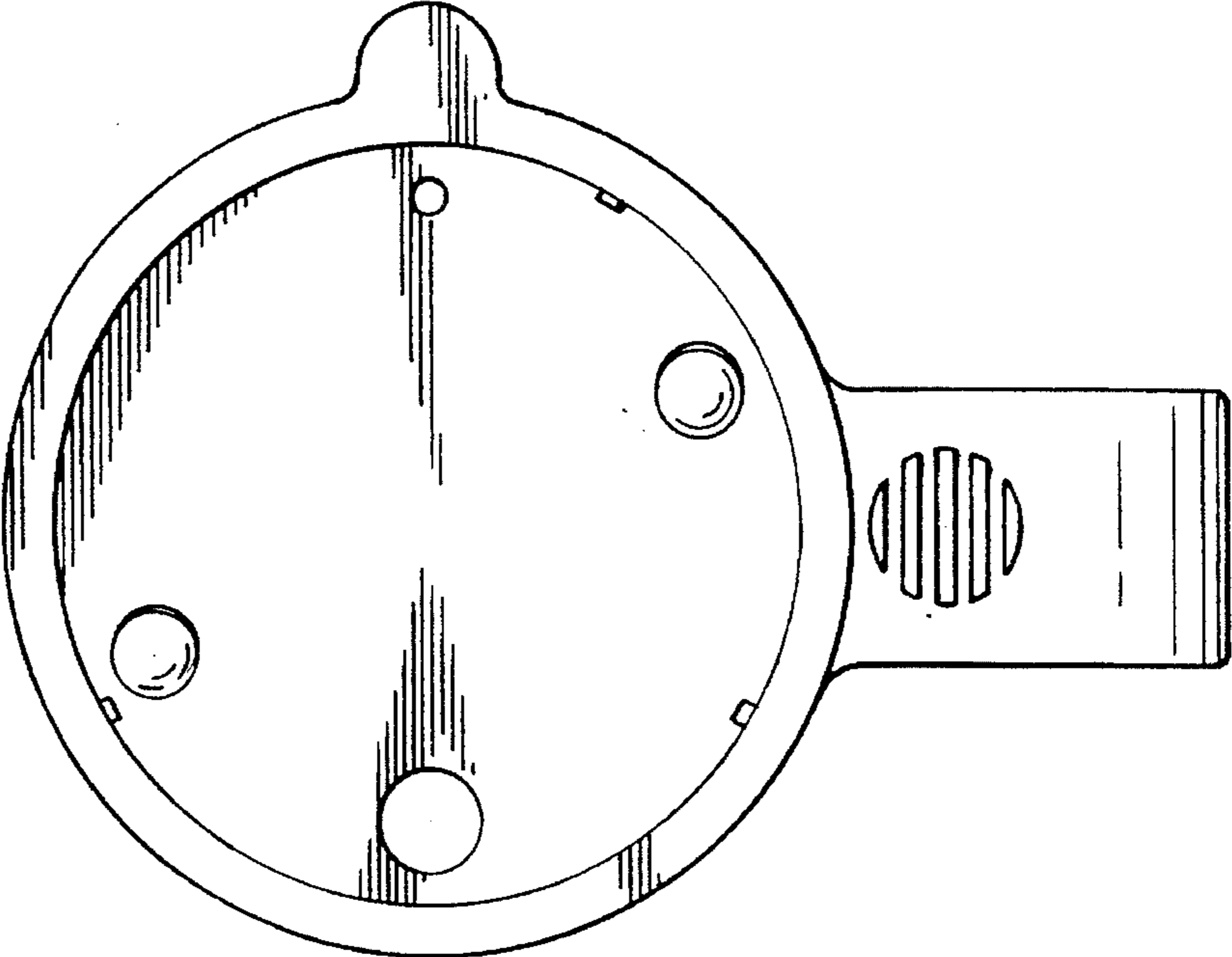

FIG.7

