



US00D368958S

United States Patent [19]

Hill et al.

[11] Patent Number: **Des. 368,958**

[45] Date of Patent: ***** Apr. 16, 1996**

[54] **FAUCET SPOUT**

[75] Inventors: **Loran R. Hill**, Indianapolis; **Anthony G. Spangler**, Sheridan, both of Ind.

[73] Assignee: **Masco Corporation of Indiana**, Taylor, Mich.

[*] Notice: The portion of the term of this patent subsequent to Jan. 9, 2010, has been disclaimed.

[**] Term: **14 Years**

[21] Appl. No.: **15,137**

[22] Filed: **Nov. 9, 1993**

[52] U.S. Cl. **D23/255**

[58] Field of Search D23/238-243, D23/250-258; 4/675, 676, 677, 678; 137/801

- D. 295,551 5/1988 Yost .
- D. 314,041 1/1991 Knapp D23/241
- D. 318,906 8/1991 Spangler .
- D. 320,645 10/1991 Knapp et al. .
- D. 321,750 11/1991 Spangler .
- D. 339,853 9/1993 Higgins et al. D23/255

OTHER PUBLICATIONS

Delta The Way Water is Brought to Life Full Line Catalog 1991.

Delta HDF Commercial Products Catalog 1991.

Primary Examiner—Louis S. Zarfes

Assistant Examiner—E. Watterson

Attorney, Agent, or Firm—Myron B. Kapustij; Malcolm L. Sutherland

[57] **CLAIM**

The ornamental design for a faucet spout, as shown and described.

DESCRIPTION

FIG. 1 is a front perspective view of a faucet spout showing our new design;

FIG. 2 is a rear perspective view thereof;

FIG. 3 is a top plan view thereof;

FIG. 4 is a front elevational view thereof;

FIG. 5 is a rear elevational view thereof;

FIG. 6 is a left side elevational view thereof, the right side being a mirror image;

FIG. 7 is a cross-sectional view taken along line 7—7 in FIG. 6; and,

FIG. 8 is a bottom plan view thereof.

The broken line showing of the aerator in FIG. 1 is for purposes of illustration only and forms no part of the claimed design.

[56] **References Cited**

U.S. PATENT DOCUMENTS

- D. 251,794 5/1979 Smith .
- D. 254,801 4/1980 Santi .
- D. 267,110 11/1982 Arnolds .
- D. 268,608 4/1983 Wilcock .
- D. 276,259 11/1984 Miller .
- D. 278,270 4/1985 Nieman .
- D. 278,271 4/1985 Nieman .
- D. 279,598 6/1985 Rademacher .
- D. 280,010 8/1985 Miller et al. .
- D. 281,095 10/1985 Arnold et al. .
- D. 286,561 11/1986 Yost .
- D. 287,747 1/1987 Miller et al. .
- D. 288,835 3/1987 Yost .
- D. 290,992 6/1987 Hill et al. .
- D. 291,117 7/1987 Ryan .
- D. 295,550 5/1988 Yost .

1 Claim, 3 Drawing Sheets

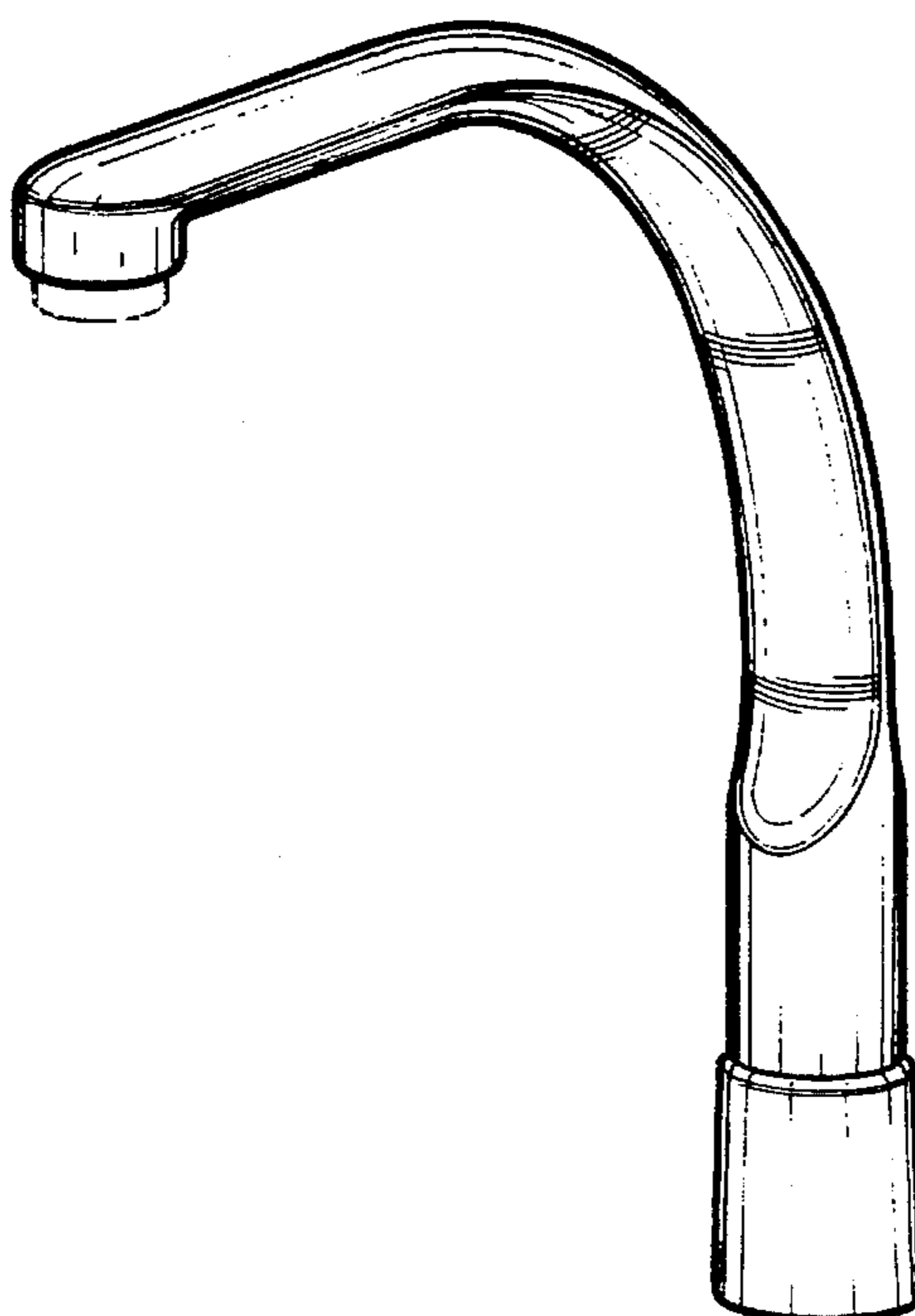

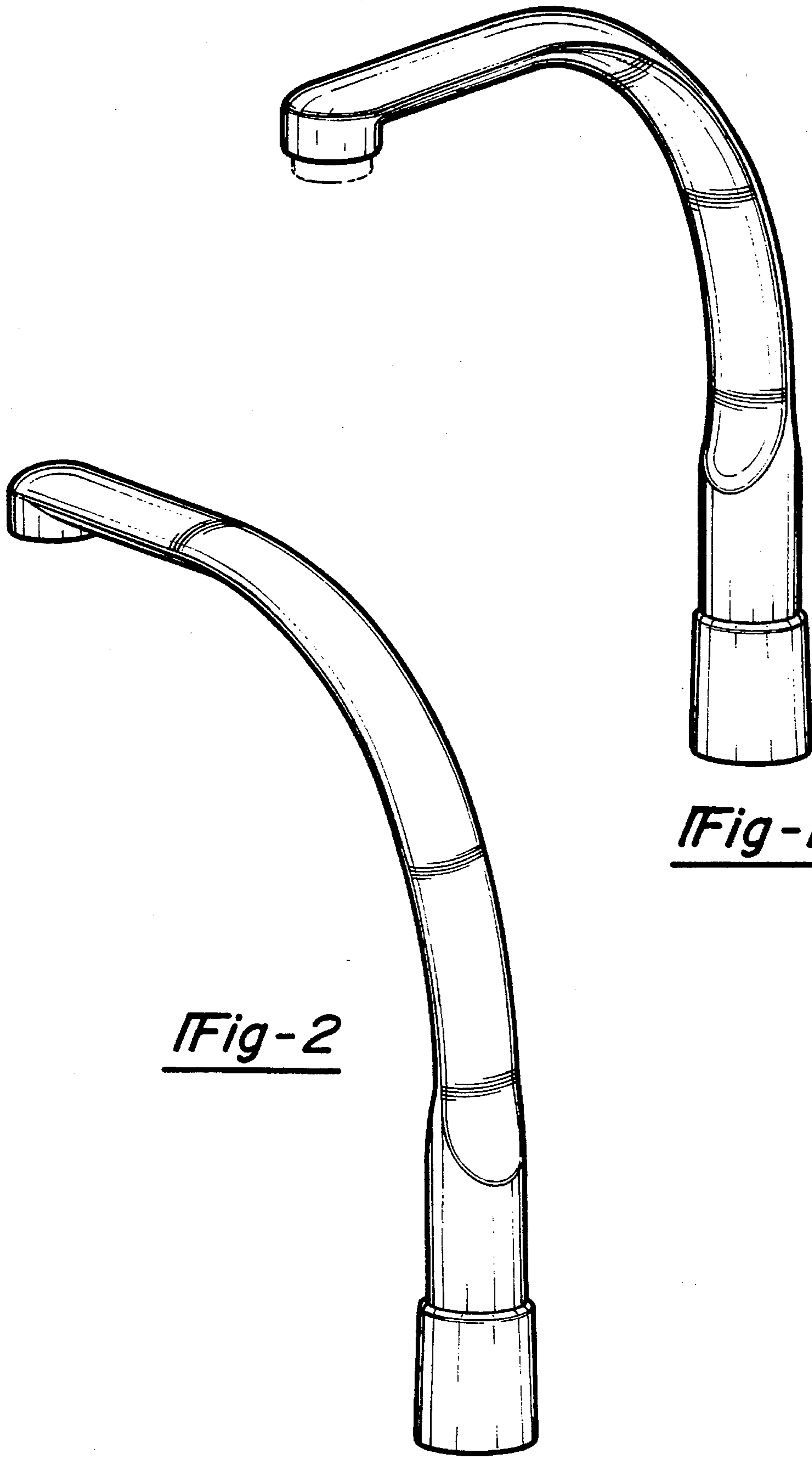

Fig-1

Fig-2

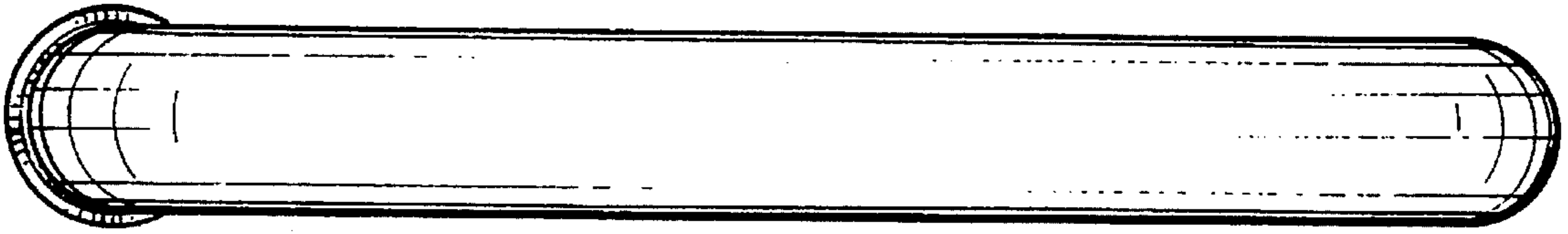

Fig-3

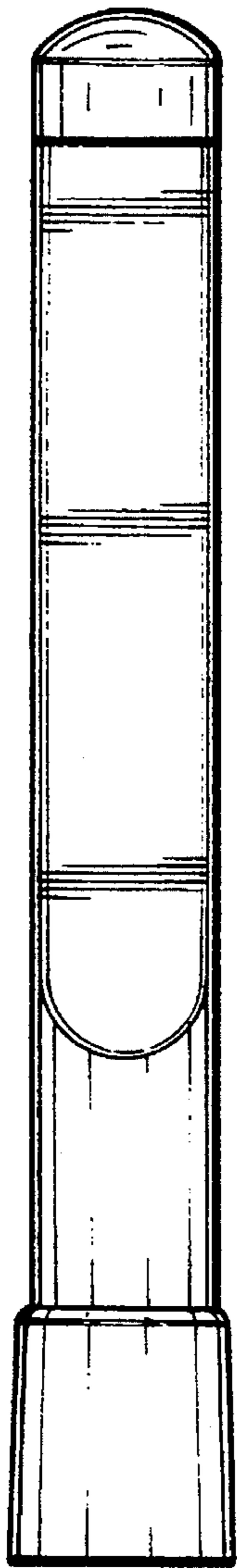

Fig-4

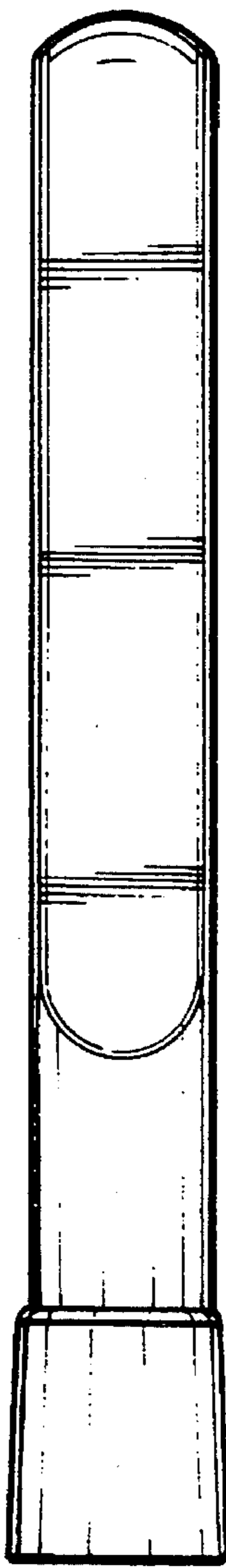

Fig-5

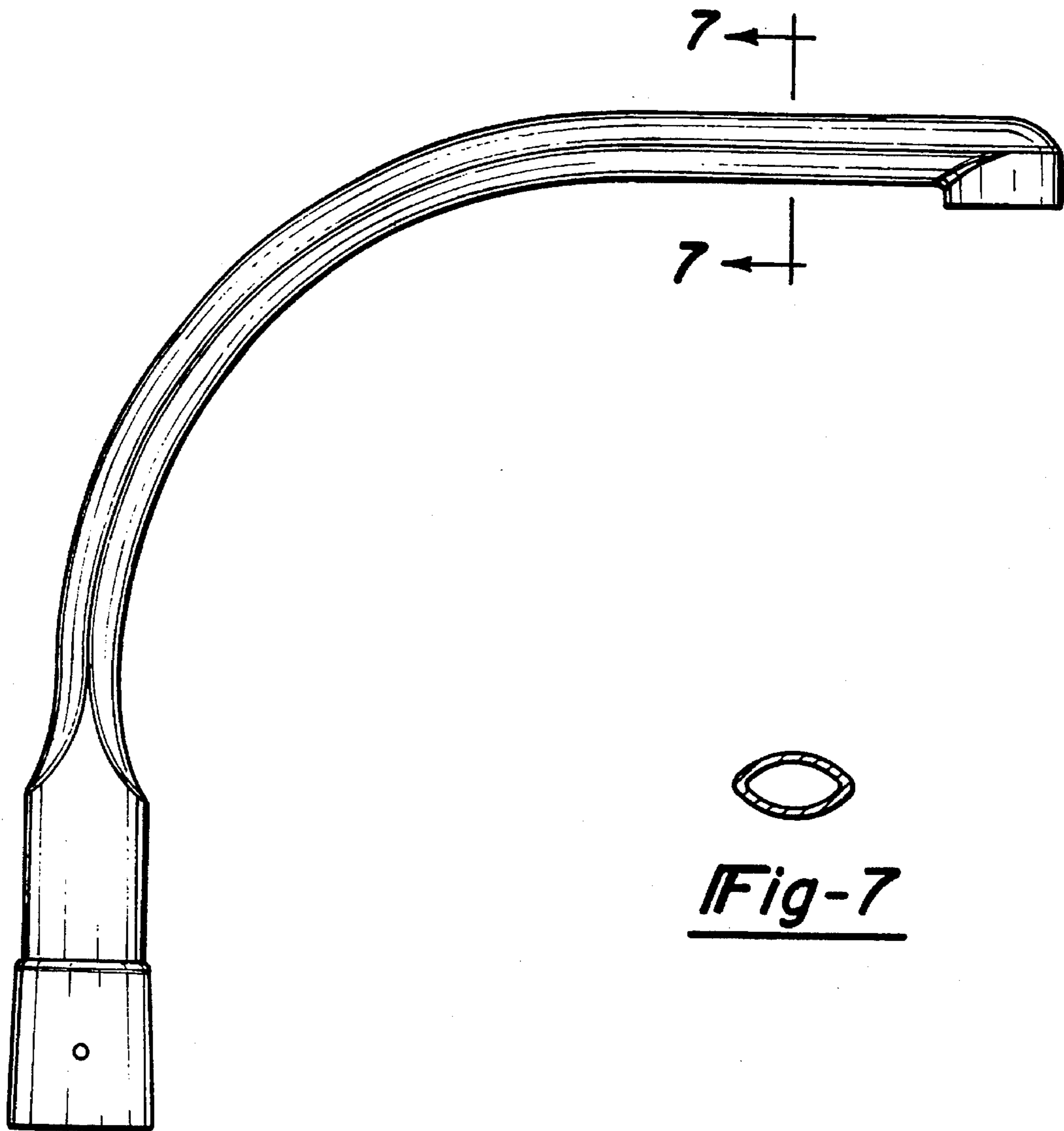

Fig-6



Fig-7

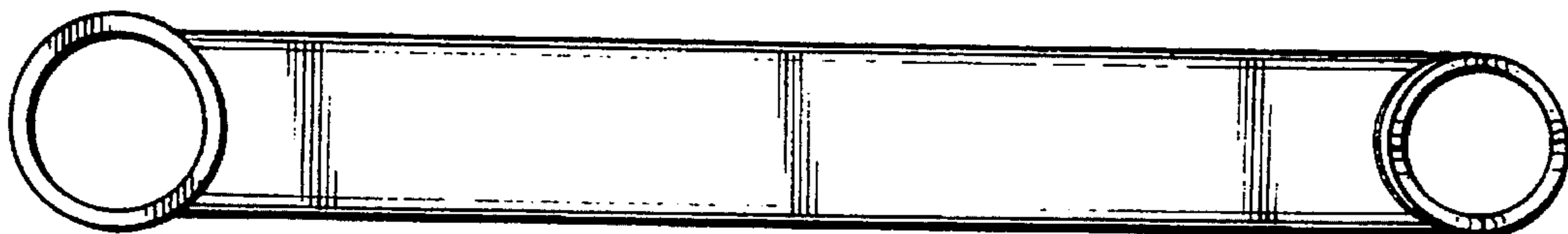

Fig-8