



US00D368946S

# United States Patent [19]

Blough et al.

[11] Patent Number: Des. 368,946

[45] Date of Patent: \*\*\* Apr. 16, 1996

[54] GOLF CLUB HEAD

[75] Inventors: R. Thomas Blough, Mineral, Va.;  
Michael E. Finn, Ft. Worth, Tex.

[73] Assignee: Ben Hogan Company, Richmond, Va.

[\*] Notice: The portion of the term of this patent subsequent to Oct. 3, 2009, has been disclaimed.

[\*\*] Term: 14 Years

[21] Appl. No.: 28,678

[22] Filed: Sep. 20, 1994

[52] U.S. Cl. .... D21/220

[58] Field of Search ..... D21/220; 273/167-175

### [56] References Cited

#### U.S. PATENT DOCUMENTS

D. 328,936	8/1992	Antonious .....	D21/220
D. 354,786	1/1995	Manning et al. ....	D21/220
D. 355,234	2/1995	MacNally et al. ....	D21/220
3,059,926	10/1962	Johnstone .	
3,655,188	4/1972	Solheim .	
4,848,747	7/1989	Fujimura et al. .	
5,011,151	4/1991	Antonious .	
5,026,056	6/1991	McNalley et al. .	

5,160,136 11/1992 Eger .  
5,160,137 11/1992 Katayama .  
5,209,473 5/1993 Fisher .

### OTHER PUBLICATIONS

Golf World; Mar. 4, 1988; p. 19; "Titleist DTR" Iron, middle right of page.

Primary Examiner—Ted Shooman  
Assistant Examiner—Mitchell I. Siegel  
Attorney, Agent, or Firm—Martin Smolowitz

### [57] CLAIM

The ornamental design for a golf club head, as shown and described.

### DESCRIPTION

FIG. 1 is a front elevational view of the golf club head showing our new design; FIG. 2 is a top plan view thereof; FIG. 3 is a right side view thereof; FIG. 4 is a left side view thereof; FIG. 5 is a bottom plan view thereof; FIG. 6 is a rear elevational view thereof; and, FIG. 7 is a cross-sectional view taken along lines 7/7 of FIG. 1.

1 Claim, 3 Drawing Sheets

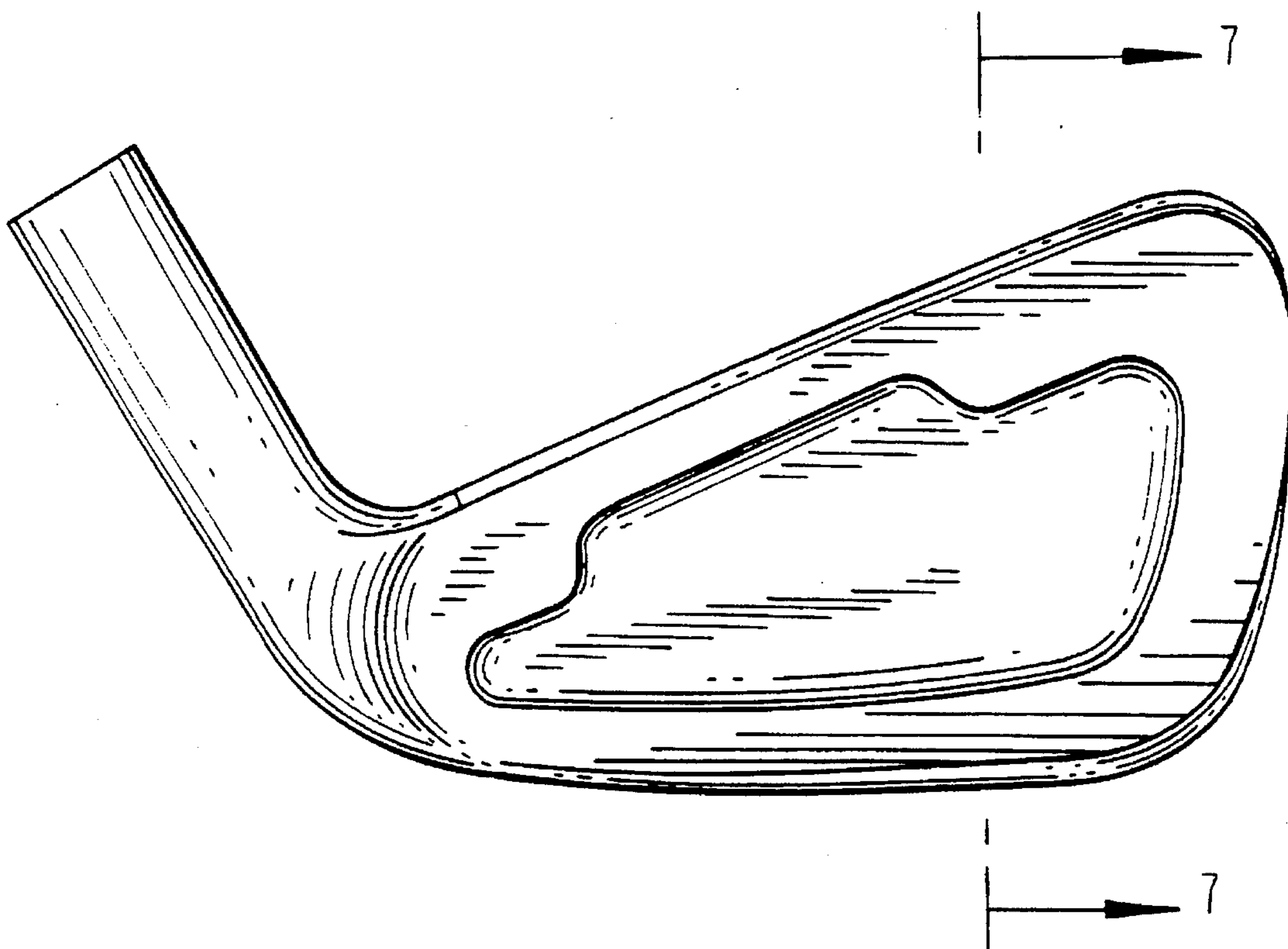

*FIG. 1*

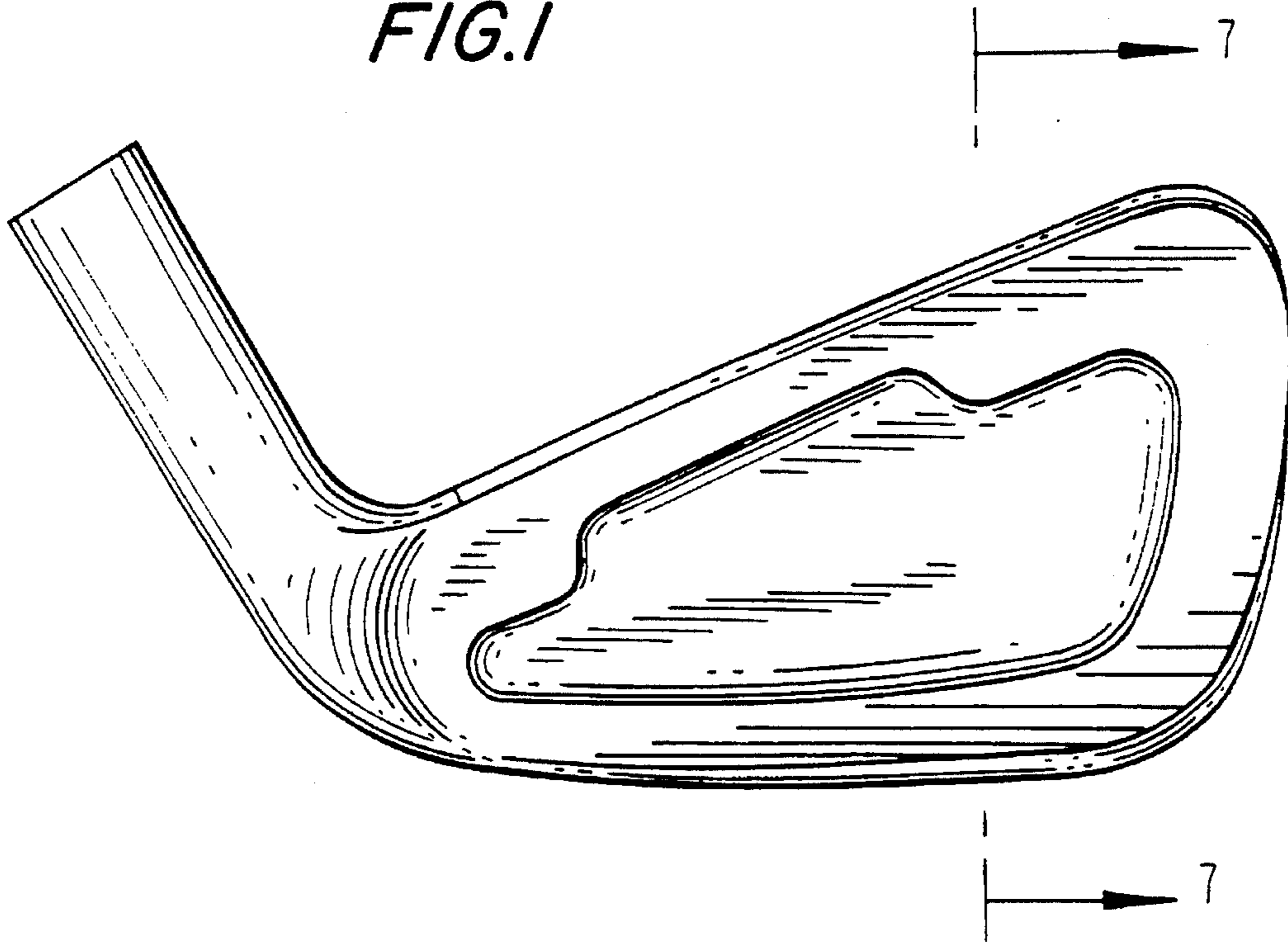

*FIG. 2*

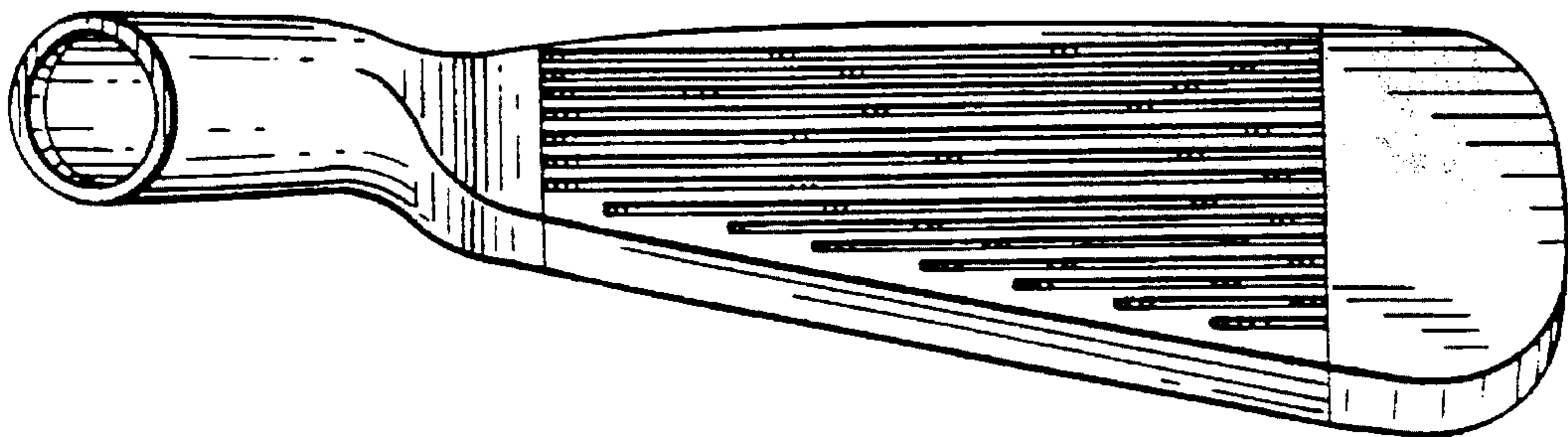

*FIG. 3*

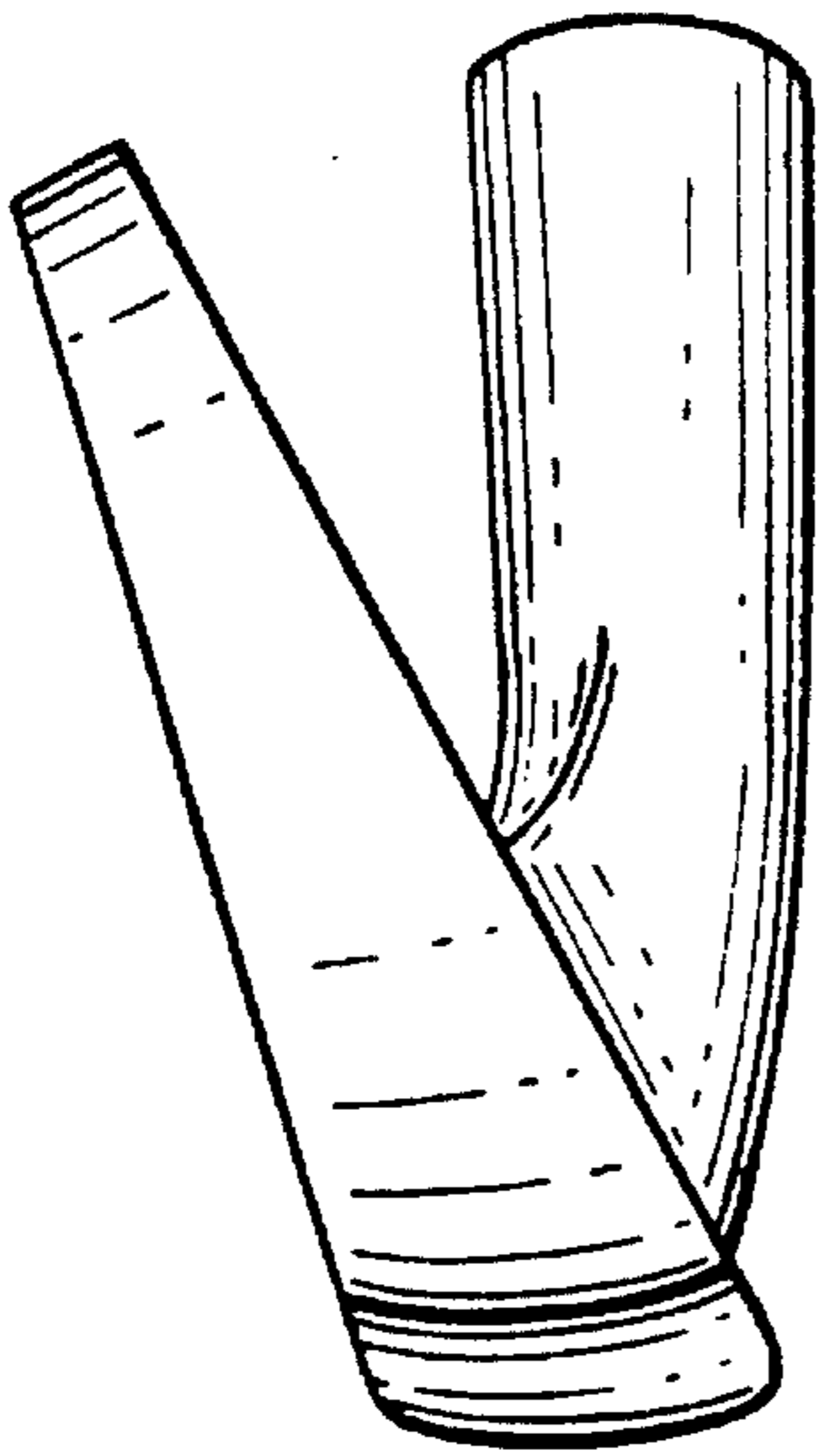

*FIG. 4*

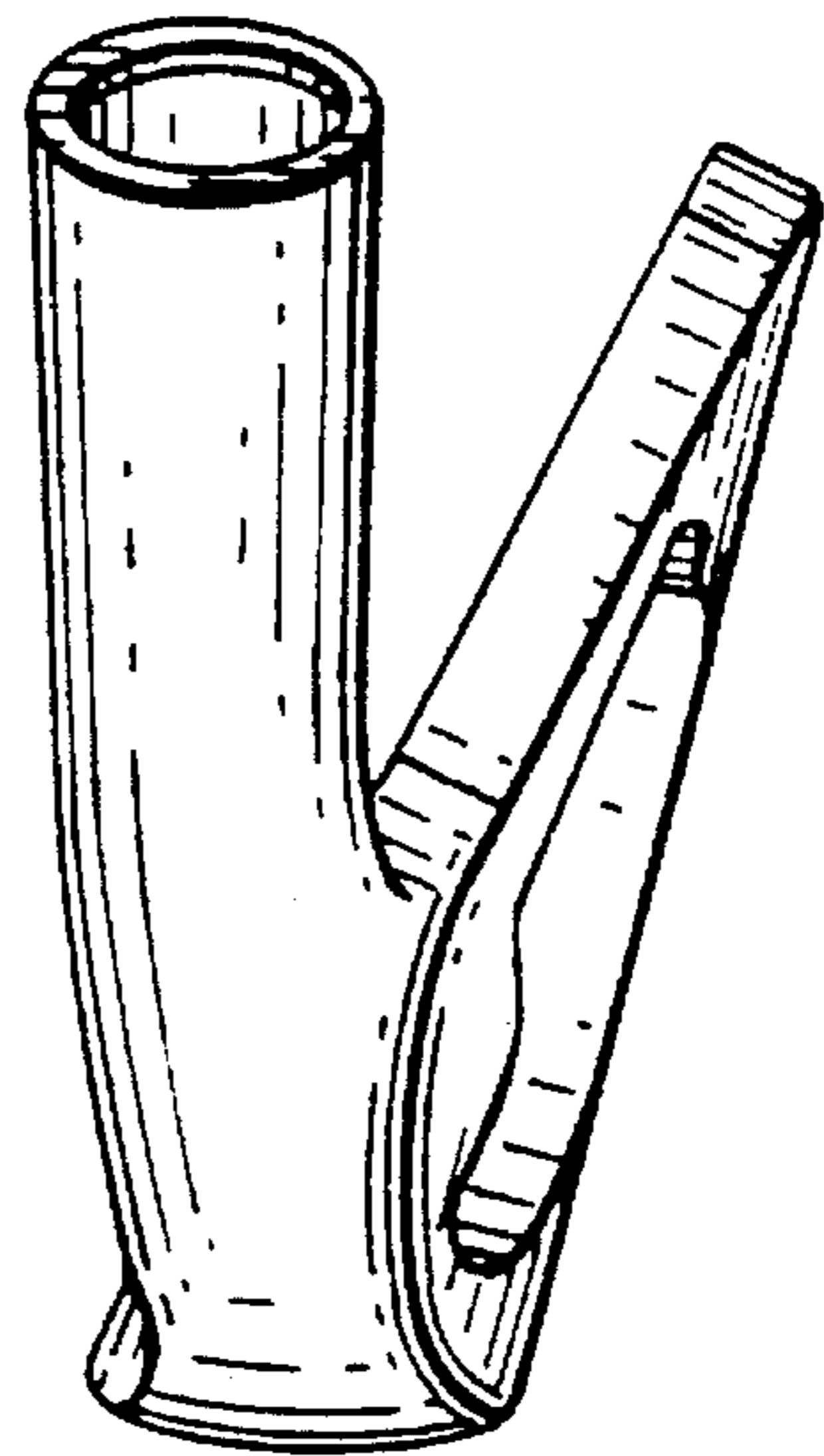

*FIG. 5*

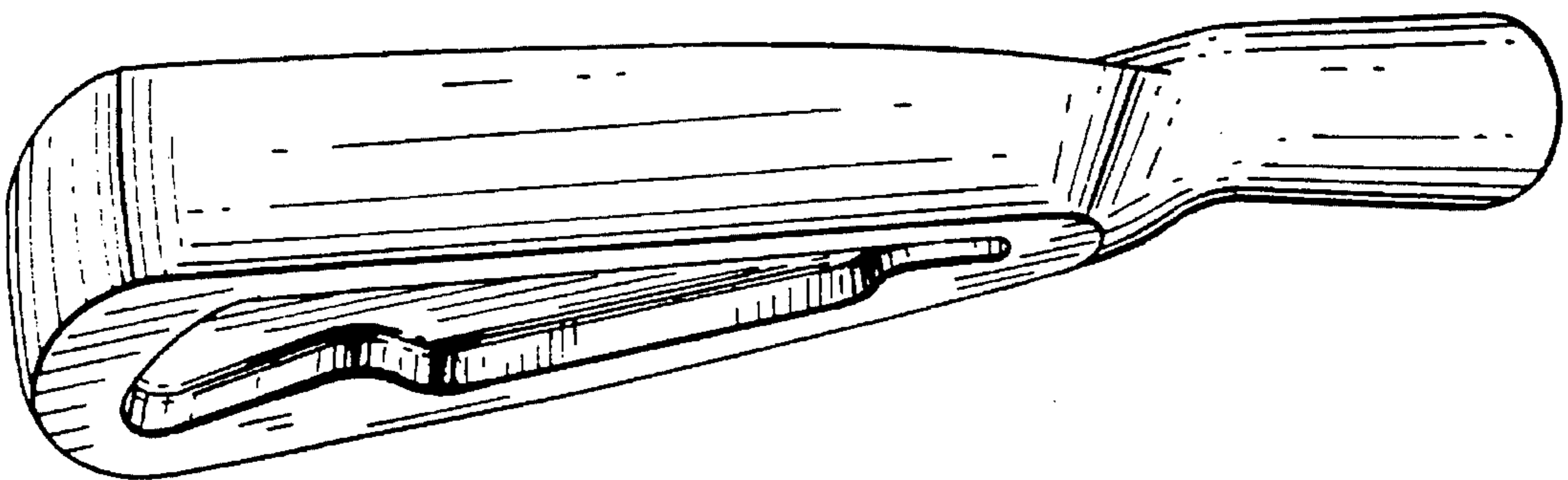

*FIG. 6*

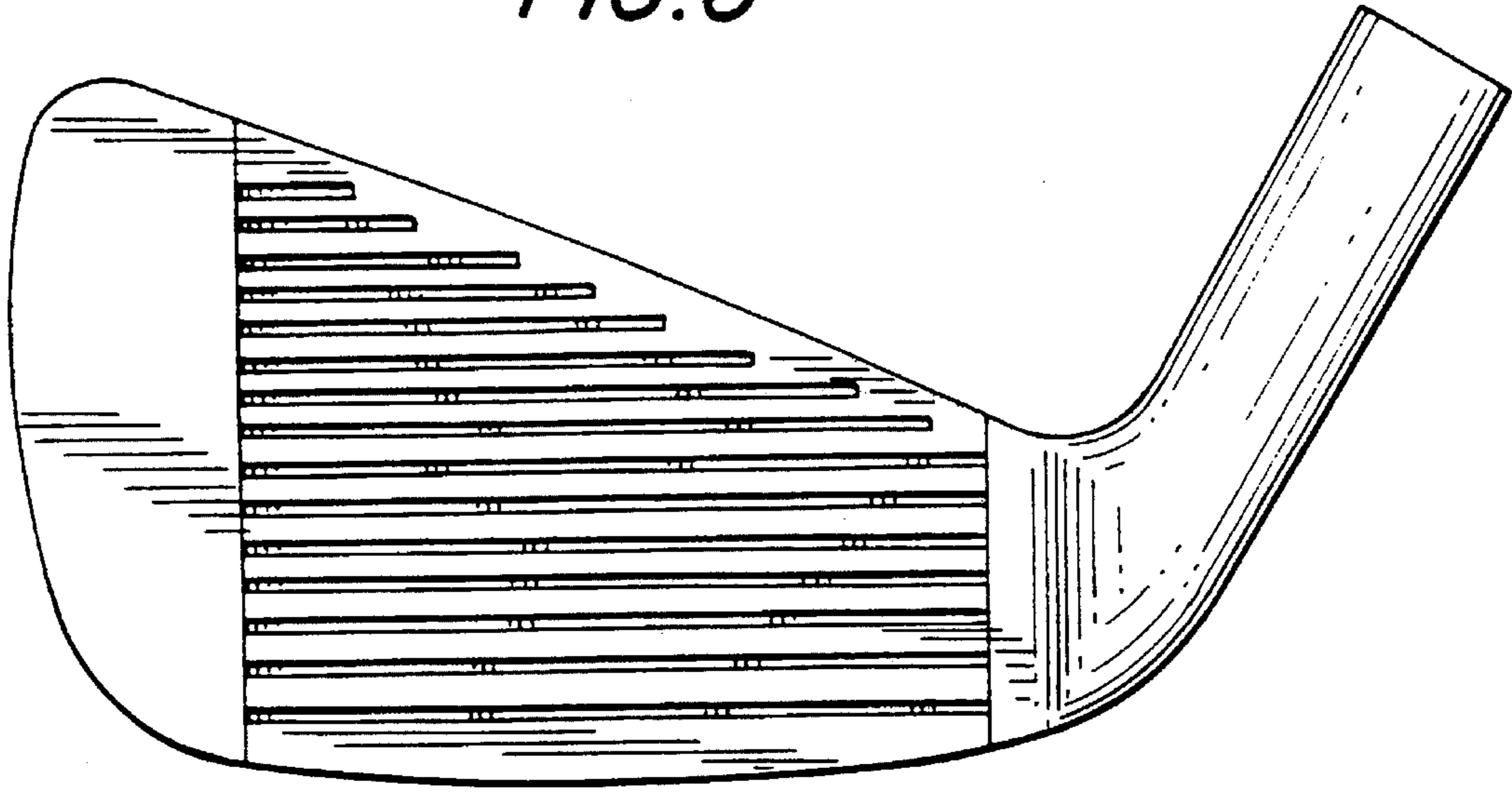

*FIG. 7*

