



US00D368937S

United States Patent [19]

Aker et al.

[11] Patent Number: **Des. 368,937**

[45] Date of Patent: ****Apr. 16, 1996**

[54] **TOY TAPE RECORDER**

[75] Inventors: **Kevin R. Aker**, Hudson; **Michael S. Jaeb**, Hiram, both of Ohio; **Mark A. Strayer**, Orchard Park, N.Y.

[73] Assignee: **The Little Tikes Company**, Hudson, Ohio

[**] Term: **14 Years**

[21] Appl. No.: **34,437**

[22] Filed: **Feb. 6, 1995**

[52] U.S. Cl. **D21/59**; D21/64; D21/112

[58] Field of Search D21/59, 64, 112; 446/397, 408; D14/161, 165, 167

P. 25, Toy tape recorder; Mattel, Inc., El Segundo, California 90245. Publication date 1991.

P. 89, Toy tape recorders; Playskool, A Division of Hasbro, Inc., 1027 Newport Avenue, P.O. Box 1059, Pawtucket, Rhode Island 02862-1059. Publication date 1993.

Pp. 80 and 81, Toy tape recorders; Tyco Playtime, 1107 Broadway, 11th Floor, New York, New York 10010. Publication date 1994.

Primary Examiner—Dominic Simone
Attorney, Agent, or Firm—Richard B. O’Planick; Lisa B. Riedesel

[57] **CLAIM**

The ornamental design for a toy tape recorder, as shown and described.

[56] **References Cited**

U.S. PATENT DOCUMENTS

D. 287,521	12/1986	Obara	D21/59	X
D. 350,132	8/1994	Klitsner et al.	D21/112	X
3,114,216	12/1963	Crawford et al.	446/408	

OTHER PUBLICATIONS

P. 23, Toy tape recorders; Toys “R” Us Flyer, *Akron Beacon Journal*, Akron, Ohio. Publication date Dec. 4, 1994.

Pp. 66 and 67, Toy tape recorders; Fisher-Price, Inc., 620 Girard Avenue, East Aurora, New York 14052-1879. Publication date 1994.

DESCRIPTION

FIG. 1 is a top left front perspective view of a toy tape recorder showing our new design;

FIG. 2 is a front elevational view thereof;

FIG. 3 is a rear elevational view thereof;

FIG. 4 is a right side elevational view thereof;

FIG. 5 is a left side elevational view thereof;

FIG. 6 is a top plan view thereof; and,

FIG. 7 is a bottom plan view thereof.

1 Claim, 3 Drawing Sheets

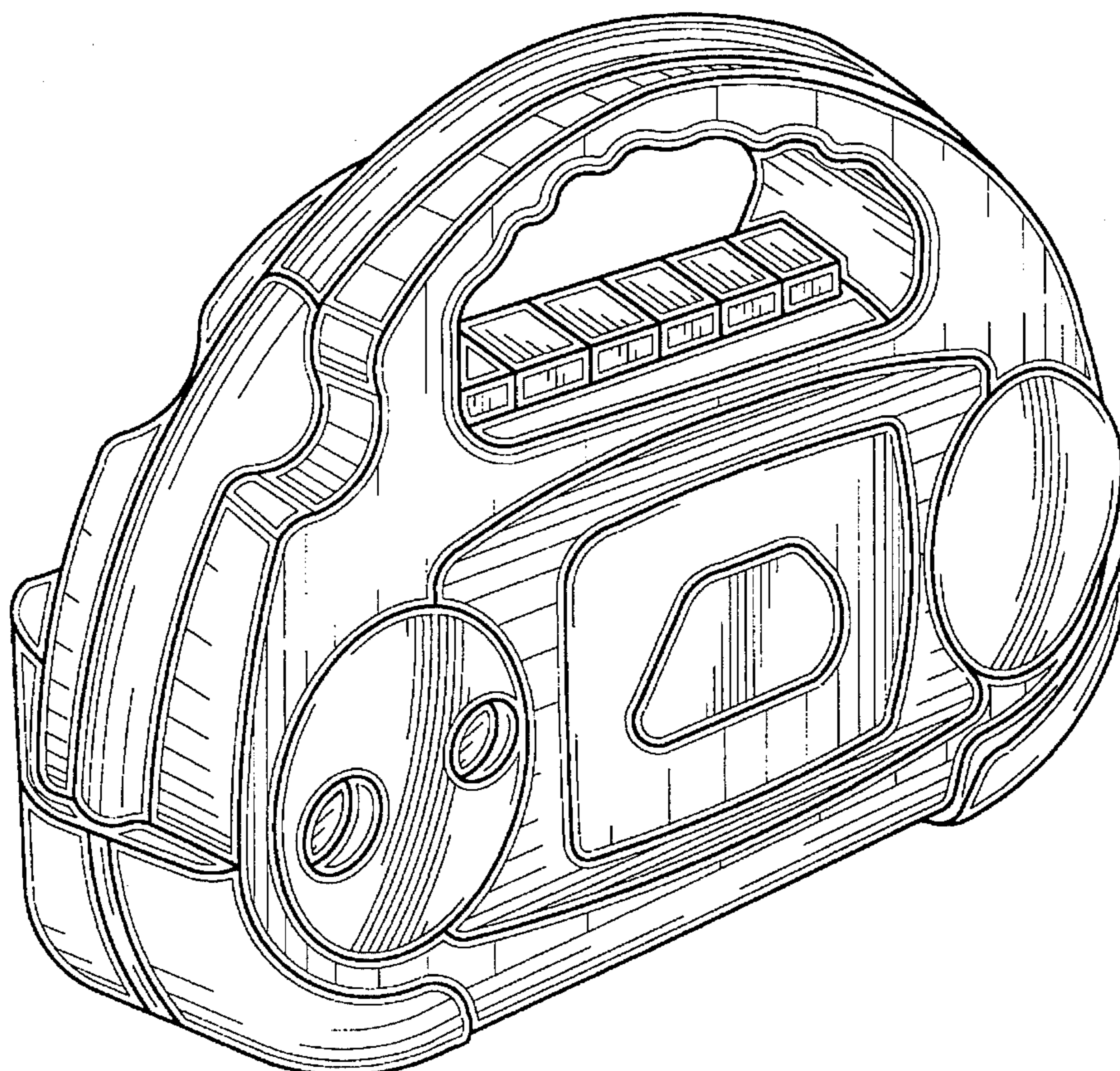

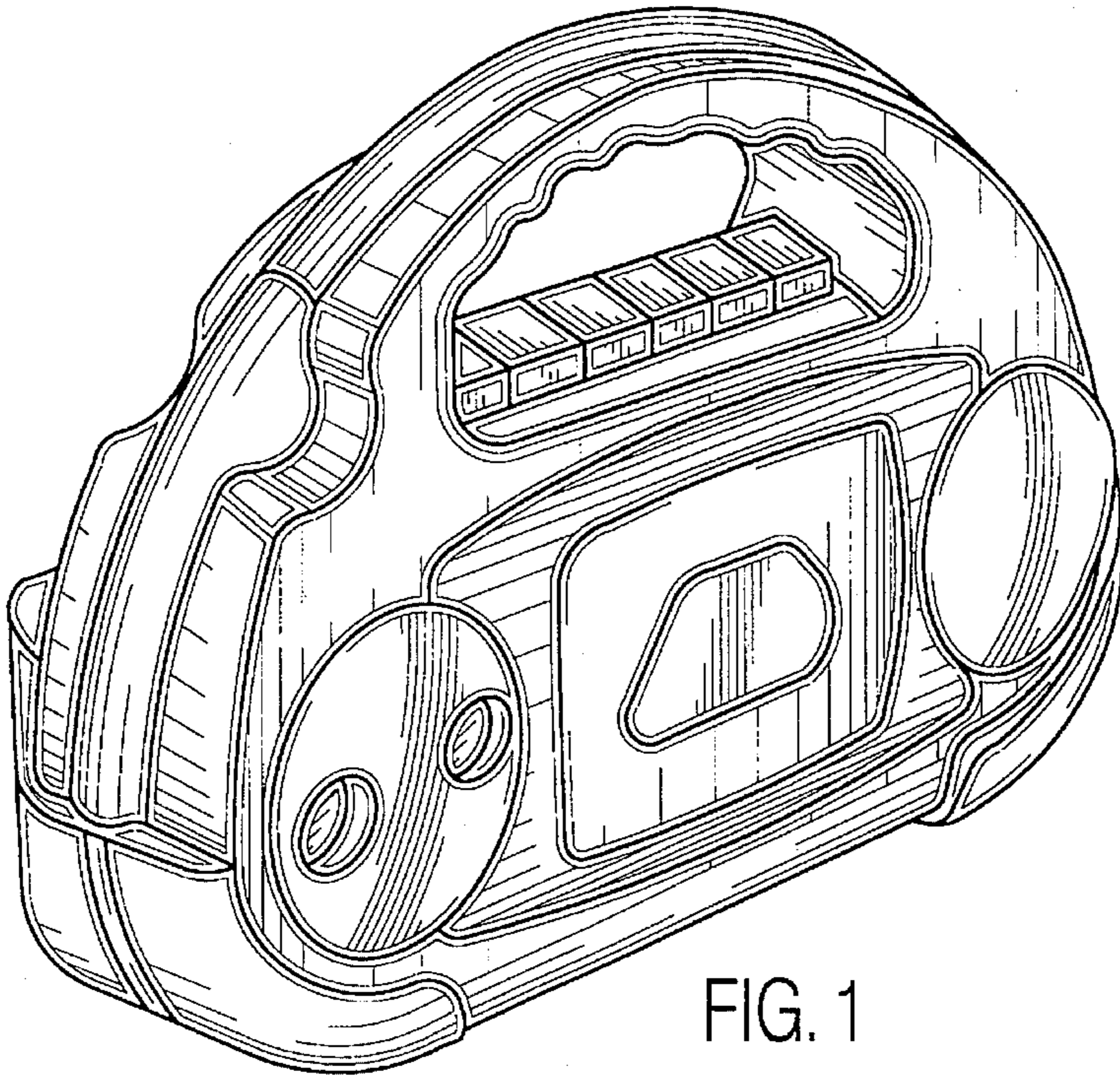

FIG. 1

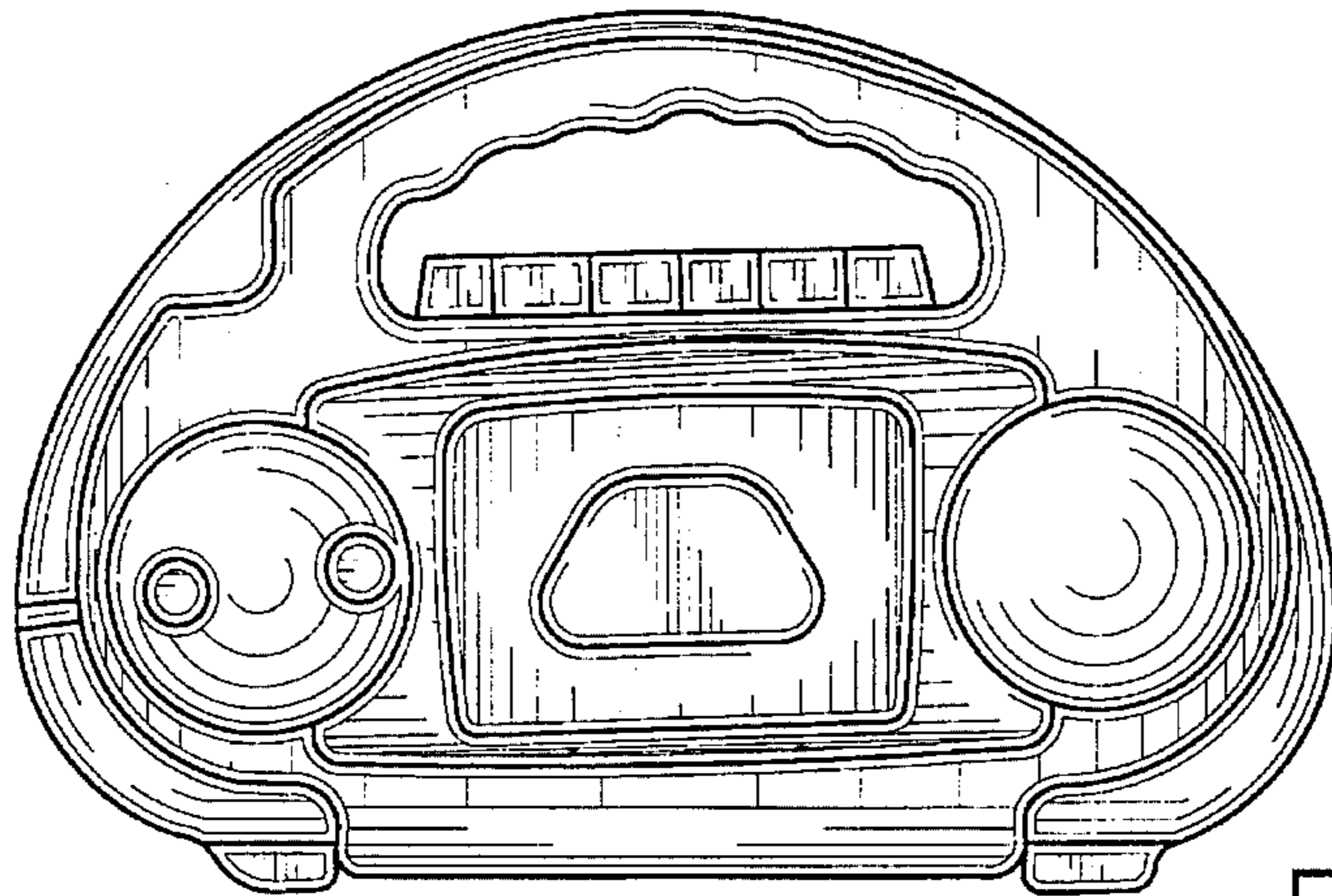

FIG. 2

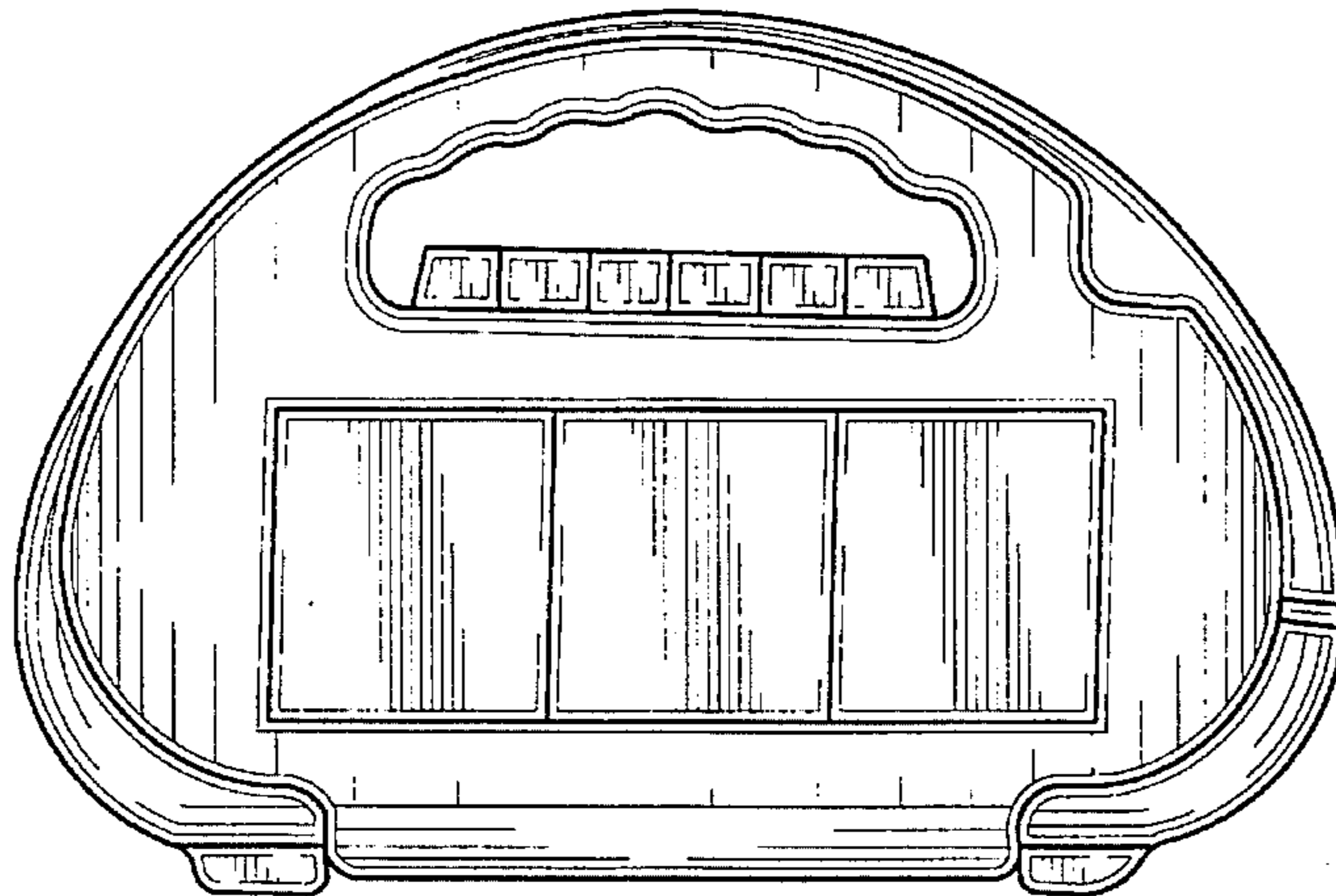

FIG. 3

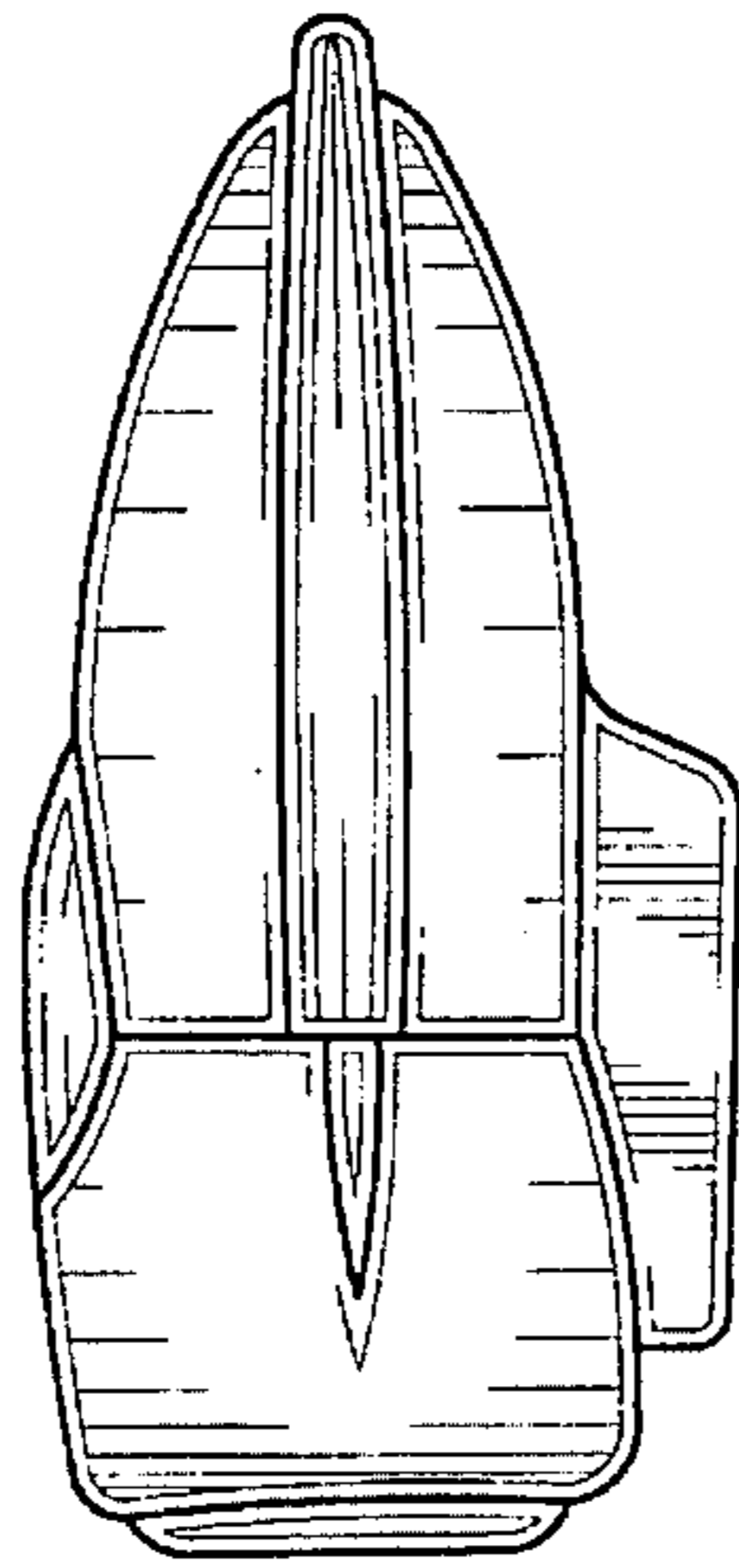

FIG. 4

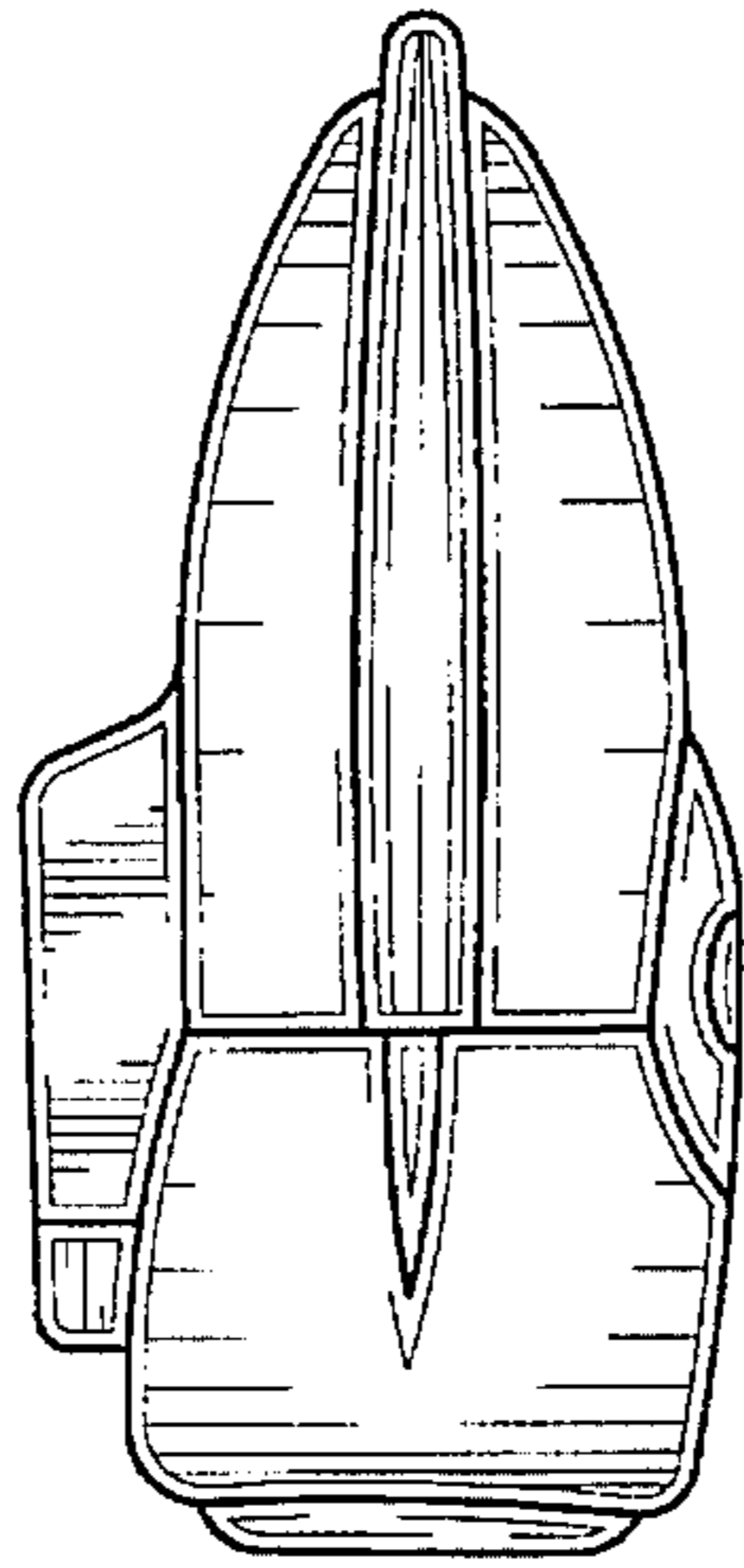

FIG. 5

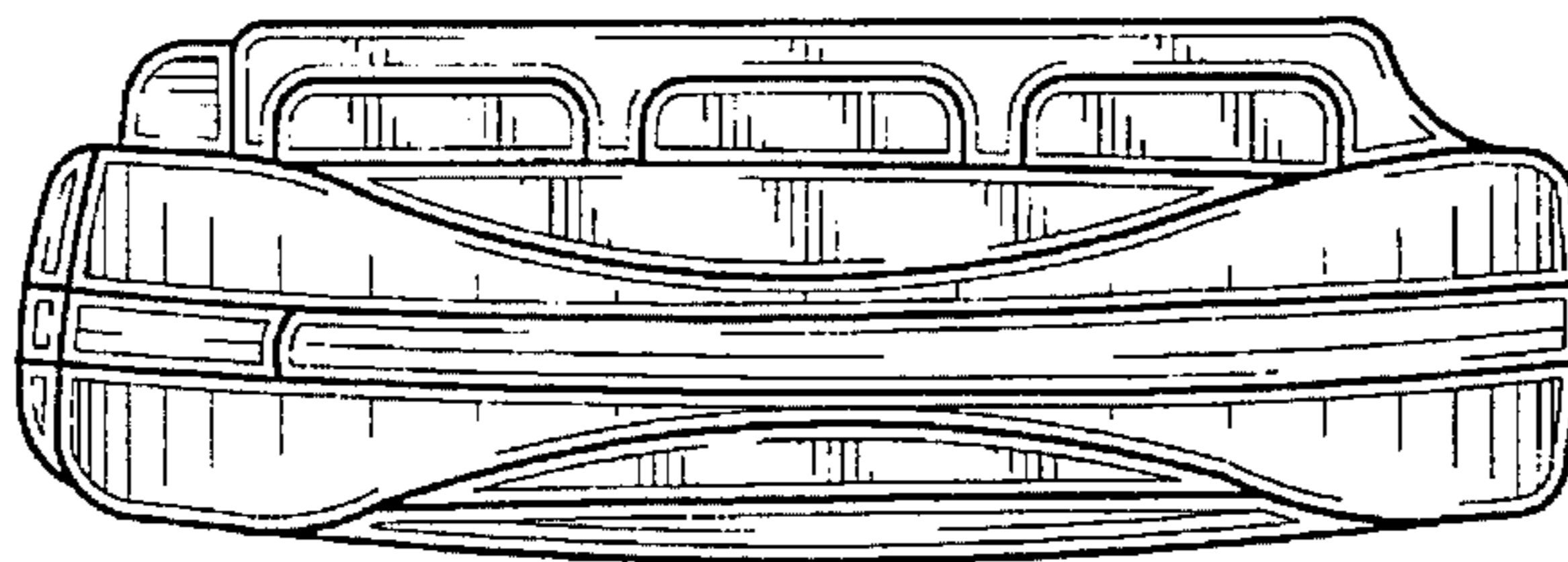

FIG. 6

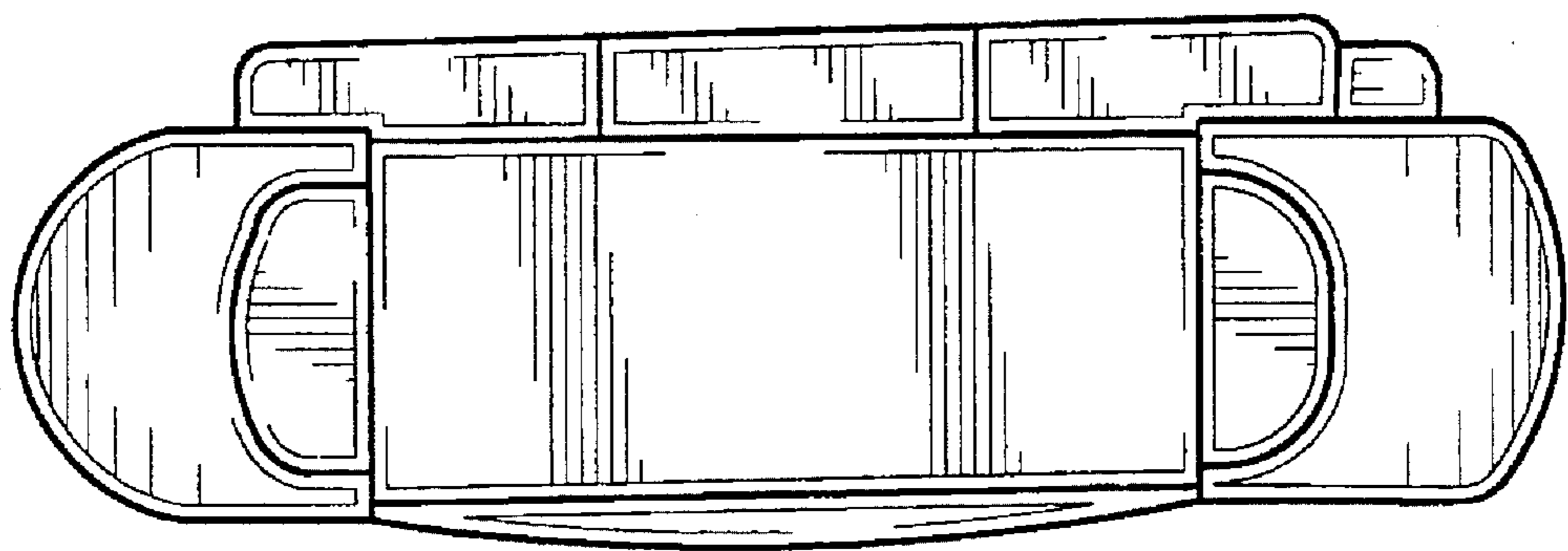

FIG. 7