



US00D368925S

United States Patent [19]
Horii

[11] **Patent Number:** **Des. 368,925**
[45] **Date of Patent:** ****Apr. 16, 1996**

[54] **ELECTRONIC WARNING MACHINE WITH CALCULATOR**

[75] Inventor: **Tsuyoshi Horii**, Tokyo, Japan

[73] Assignee: **Casio Computer Co., Ltd.**, Tokyo, Japan

[**] Term: **14 Years**

[21] Appl. No.: **25,084**

[22] Filed: **Jun. 27, 1994**

[52] U.S. Cl. **D18/2**

[58] Field of Search D14/100, 106,
D14/115; D18/2, 6, 7; 364/706, 707, 708.1,
709.01-709.16, 710

[56] **References Cited**

U.S. PATENT DOCUMENTS

D. 309,601	7/1990	Sawada et al.	D18/7 X
D. 317,440	6/1991	Sawada et al.	D18/7 X
D. 328,089	7/1992	Haneda	D18/7 X
D. 334,736	4/1993	Sawada et al.	D14/100

Primary Examiner—Alan P. Douglas

Assistant Examiner—S. Snapp

Attorney, Agent, or Firm—Frishauf, Holtz, Goodman, Langer & Chick

[57] **CLAIM**

The ornamental design for an electronic warning machine with calculator, as shown and described.

DESCRIPTION

FIG. 1 is a front elevational view of an electronic warning

machine (the machine) with calculator showing my new design;

FIG. 2 is a right side elevational view thereof;

FIG. 3 is a left side elevational view thereof;

FIG. 4 is a top plan view thereof;

FIG. 5 is a bottom plan view thereof;

FIG. 6 is a rear elevational view thereof;

FIG. 7 is a perspective view thereof;

FIG. 8 is a rear elevational view of the machine with a hanging member in position;

FIG. 9 is a right side elevational view of FIG. 8;

FIG. 10 is a front elevational view of the machine with the cover opened;

FIG. 11 is a right side elevational view of the machine with the cover opened;

FIG. 12 is a left side elevational view of the machine with the cover opened;

FIG. 13 is a top plan view of the machine with the cover opened; and,

FIG. 14 is a bottom plan view of the machine with the cover opened.

1 Claim, 4 Drawing Sheets

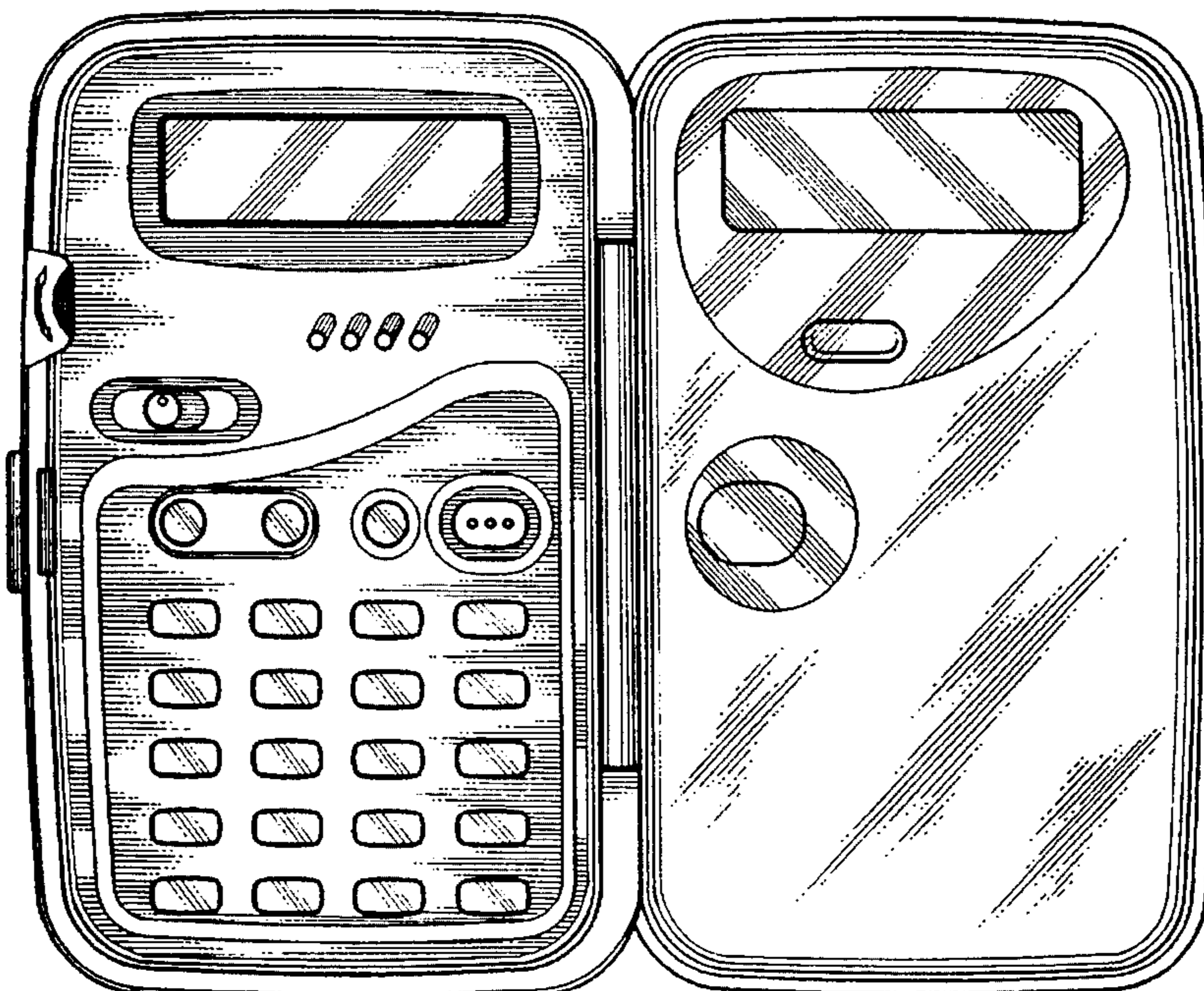

FIG. 4

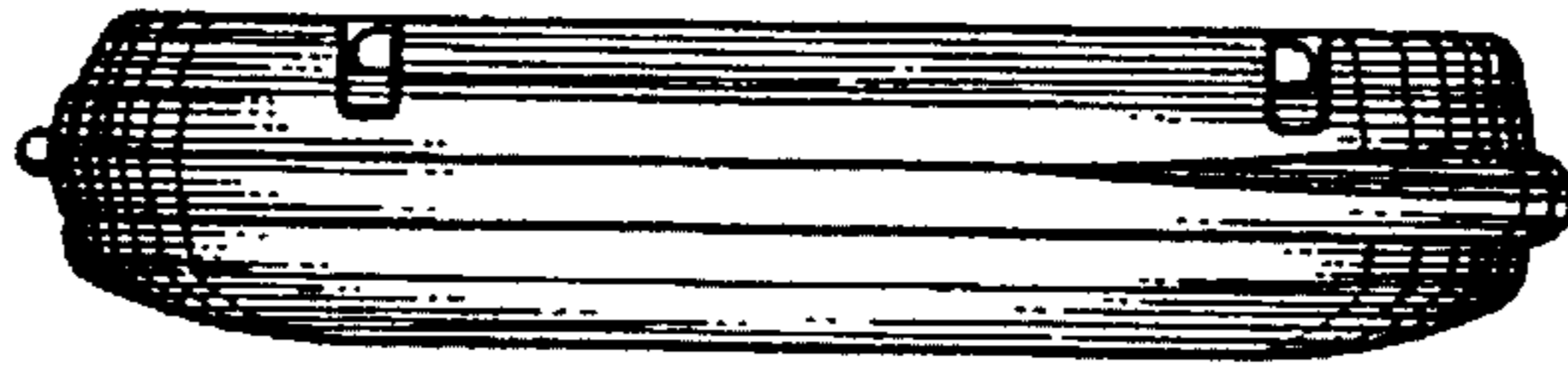

FIG. 3

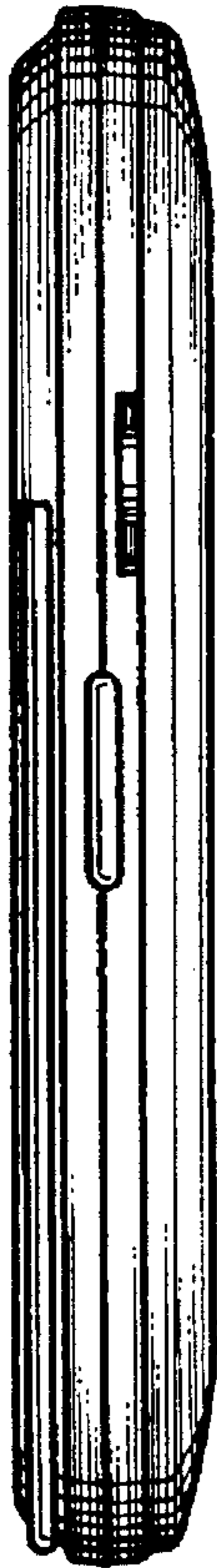

FIG. 1

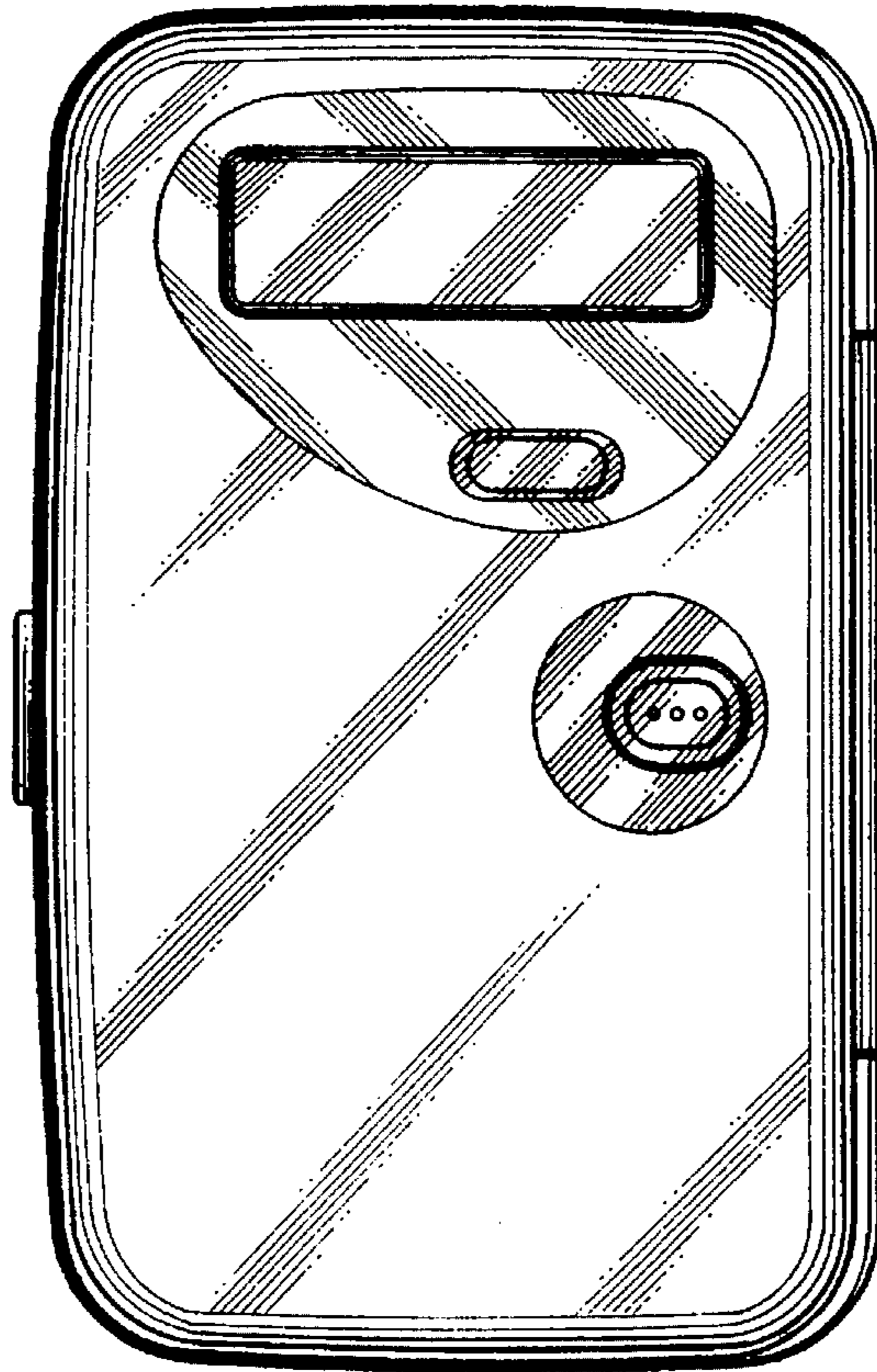

FIG. 2

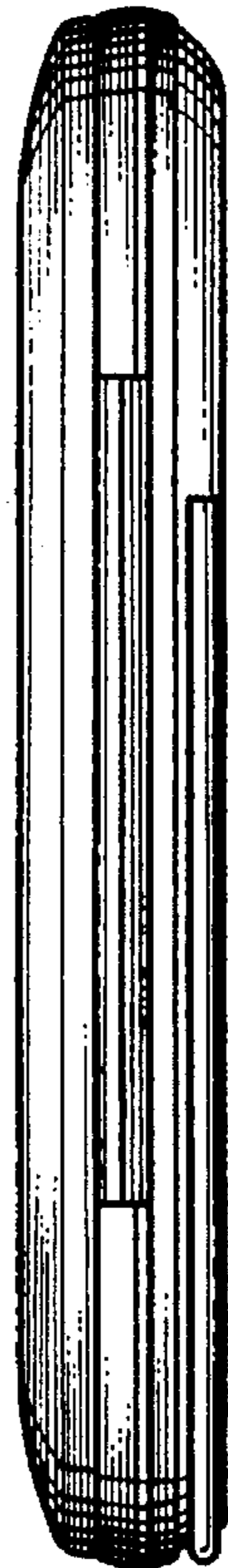
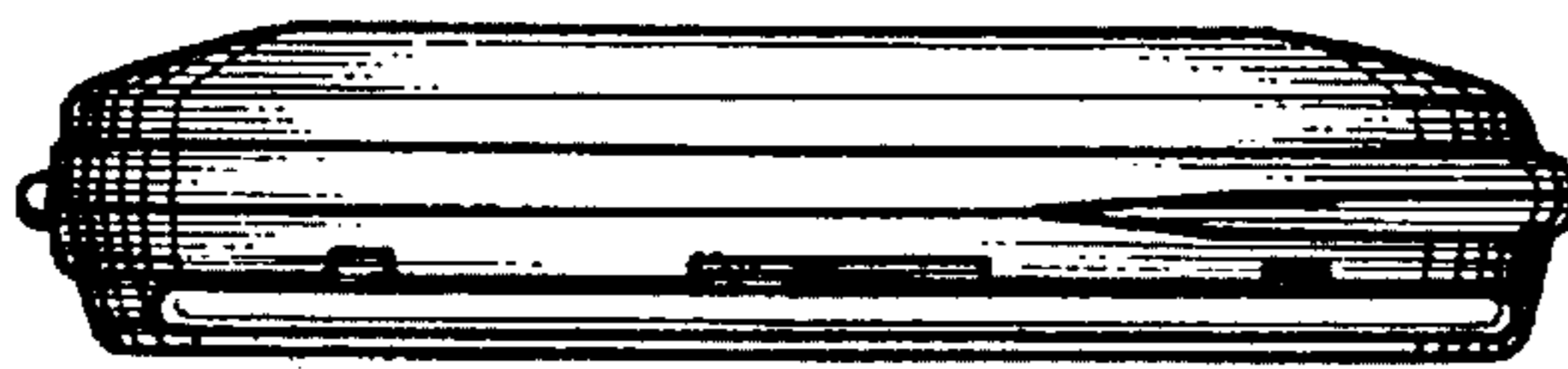

FIG. 5



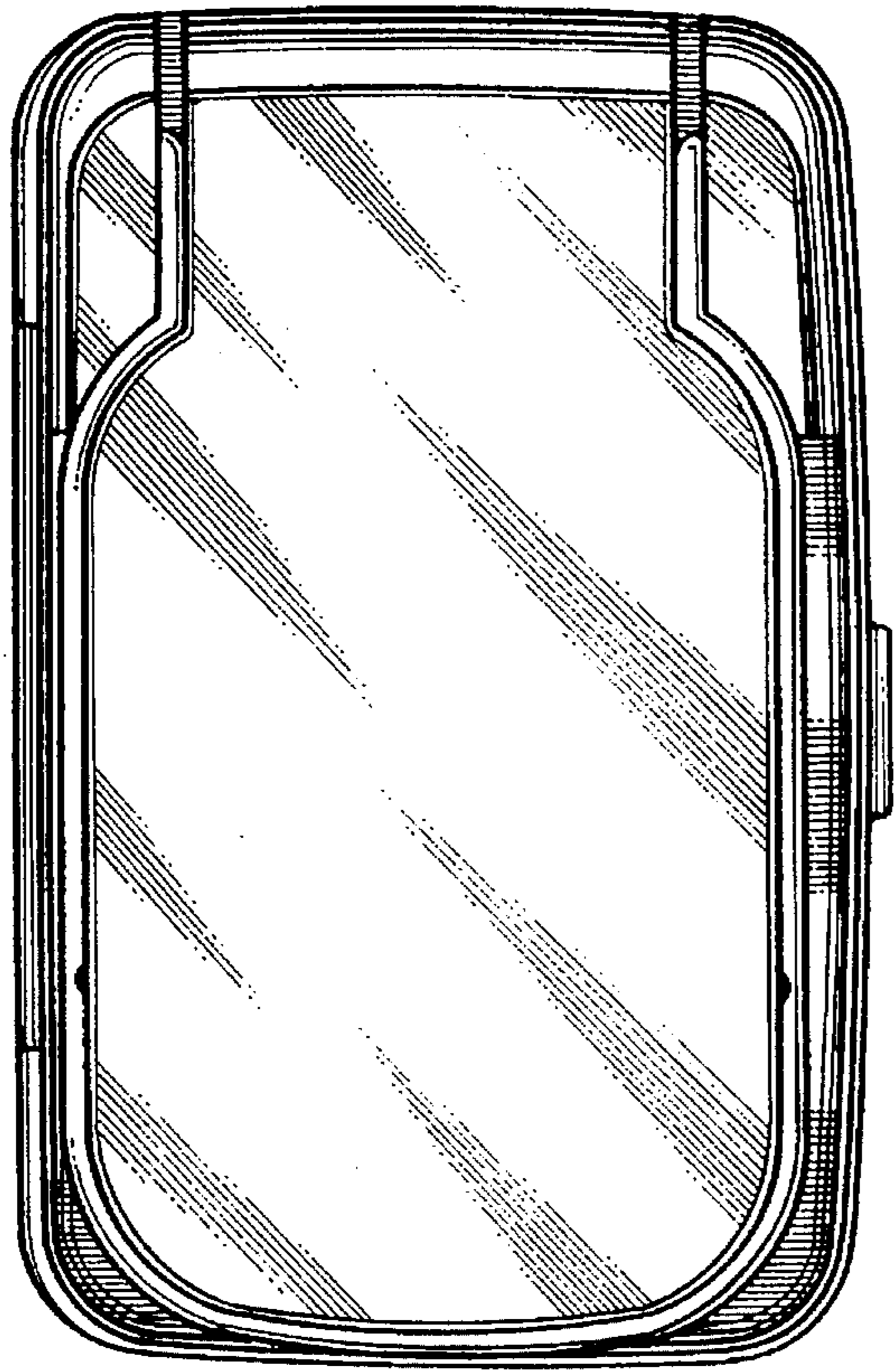

FIG. 6

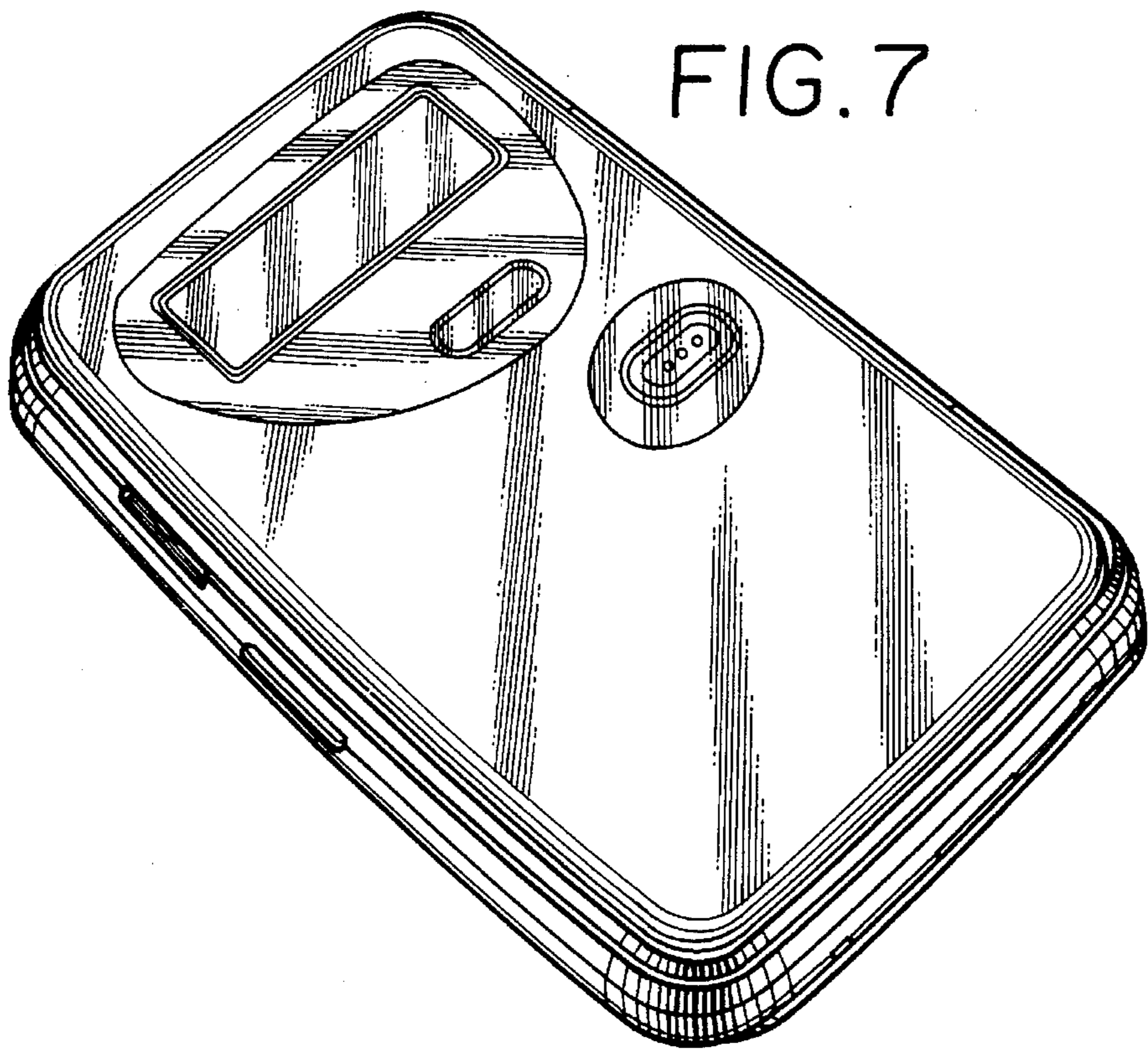

FIG. 7

FIG. 8

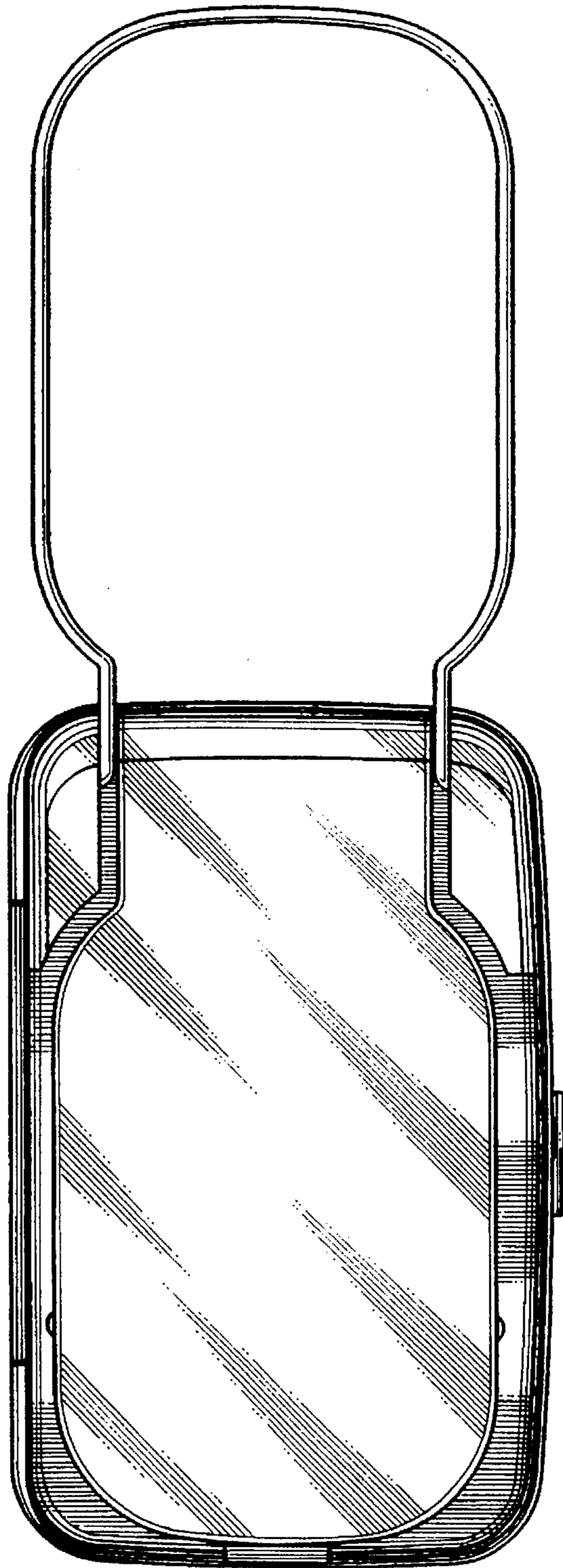

FIG. 9



FIG.13

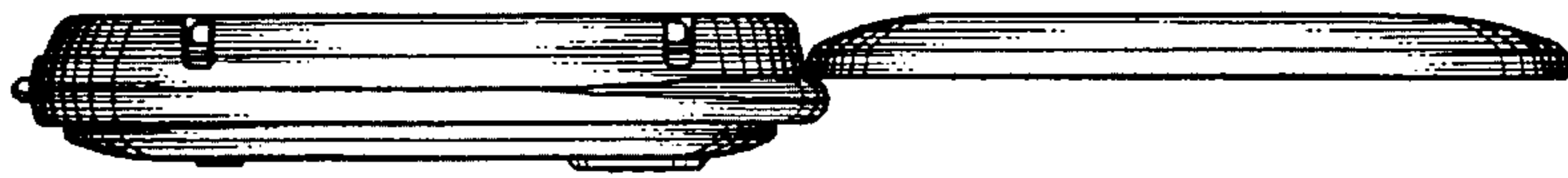

FIG.12



FIG.10

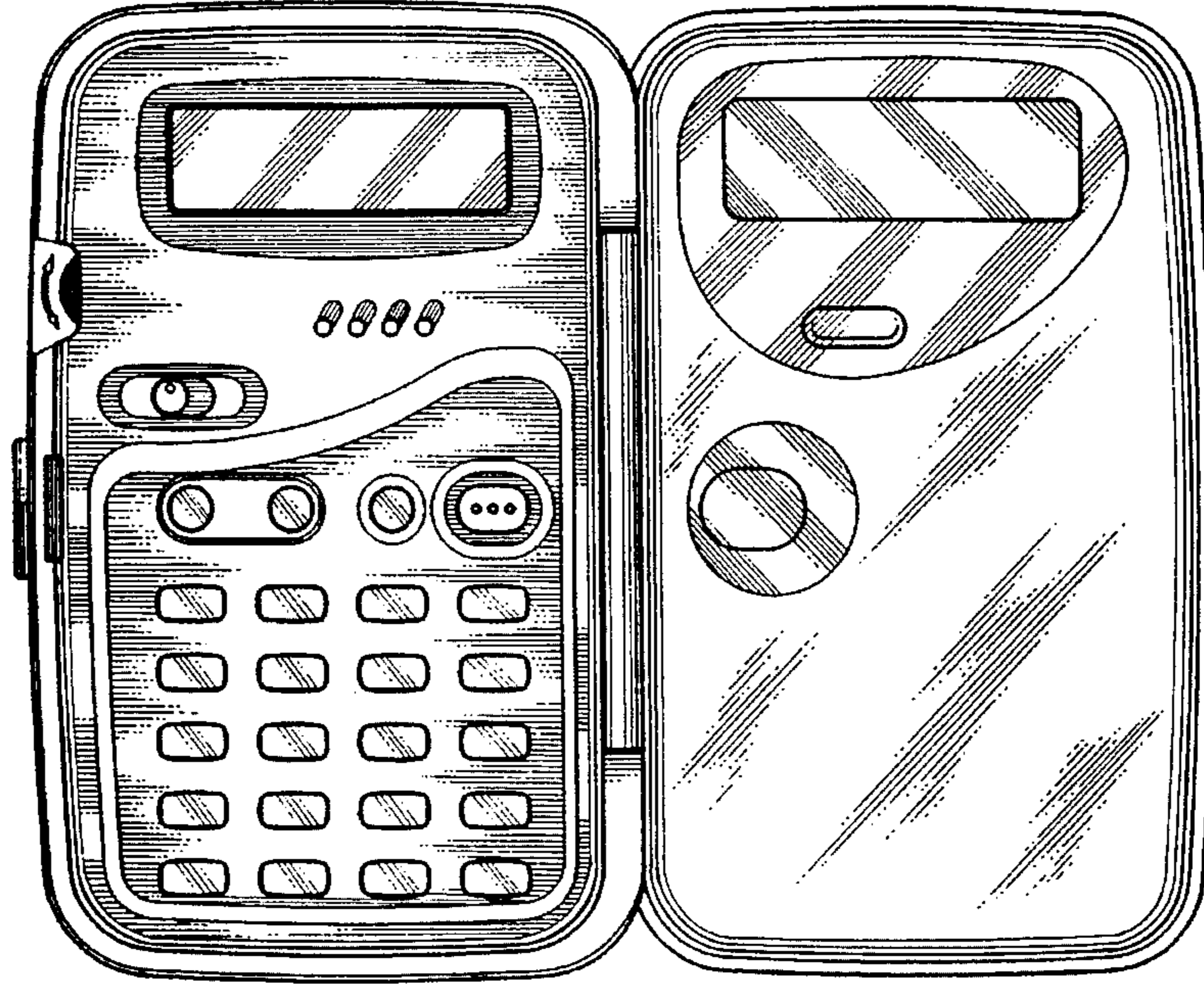

FIG.11



FIG.14

