



US00D368915S

United States Patent [19]

[11] Patent Number: **Des. 368,915**

Braun

[45] Date of Patent: ****Apr. 16, 1996**

[54] **APPARATUS KIT FOR MAKING BIAS STRIPS**

Primary Examiner—Antoine Duval Davis
Attorney, Agent, or Firm—Richard C. Litman

[76] Inventor: **Elaine A. Braun**, P.O. Box 211145,
Auke Bay, Ak. 99821

[57] **CLAIM**

[**] Term: **14 Years**

The ornamental design for an apparatus kit for making bias strips, as shown and described.

[21] Appl. No.: **38,427**

DESCRIPTION

[22] Filed: **May 5, 1995**

[52] U.S. Cl. **D15/78**

[58] Field of Search D15/66-68, 77,
D15/78; D10/64, 65; 33/2 R, 2 H, 2 A,
11-17 A; 38/102.2, 102.3; 223/1, 44, 52,
52.5, 52.6

FIG. 1 is a perspective view of an apparatus kit for making bias strips of the first embodiment showing my new design. The other three embodiments being identical except for the width of the centrally disposed depression and the width of the template;

[56] References Cited

U.S. PATENT DOCUMENTS

D. 29,500	10/1898	Draper	D15/78
3,029,004	4/1962	Schiavone	33/16 X
3,197,875	8/1965	D'Azzo	33/2 R X
3,478,366	11/1969	Kaufman	.	
4,353,760	10/1982	Moertel	223/44 X
4,395,964	8/1983	Warren	.	
5,141,140	8/1992	Moffett-Hall	.	

FIG. 2 is a front elevational view of embodiment 2;
FIG. 3 is a front elevational view of embodiment 1;
FIG. 4 is a front elevational view of embodiment 3;
FIG. 5 is a front elevational view of embodiment 4;
FIG. 6 is a rear elevational view of embodiment 2;
FIG. 7 is a rear elevational view of embodiment 1;
FIG. 8 is a rear elevational view of embodiment 3;
FIG. 9 is a rear elevational view of embodiment 4;
FIG. 10 is a top view of embodiment 2;
FIG. 11 is a top view of embodiment 1;
FIG. 12 is a top view of embodiment 3;
FIG. 13 is a top view of embodiment 4; and,
FIG. 14 is a typical right side elevational view, with the left side elevational view being a mirror image thereof.

FOREIGN PATENT DOCUMENTS

59-53773 3/1984 Japan .

1 Claim, 8 Drawing Sheets

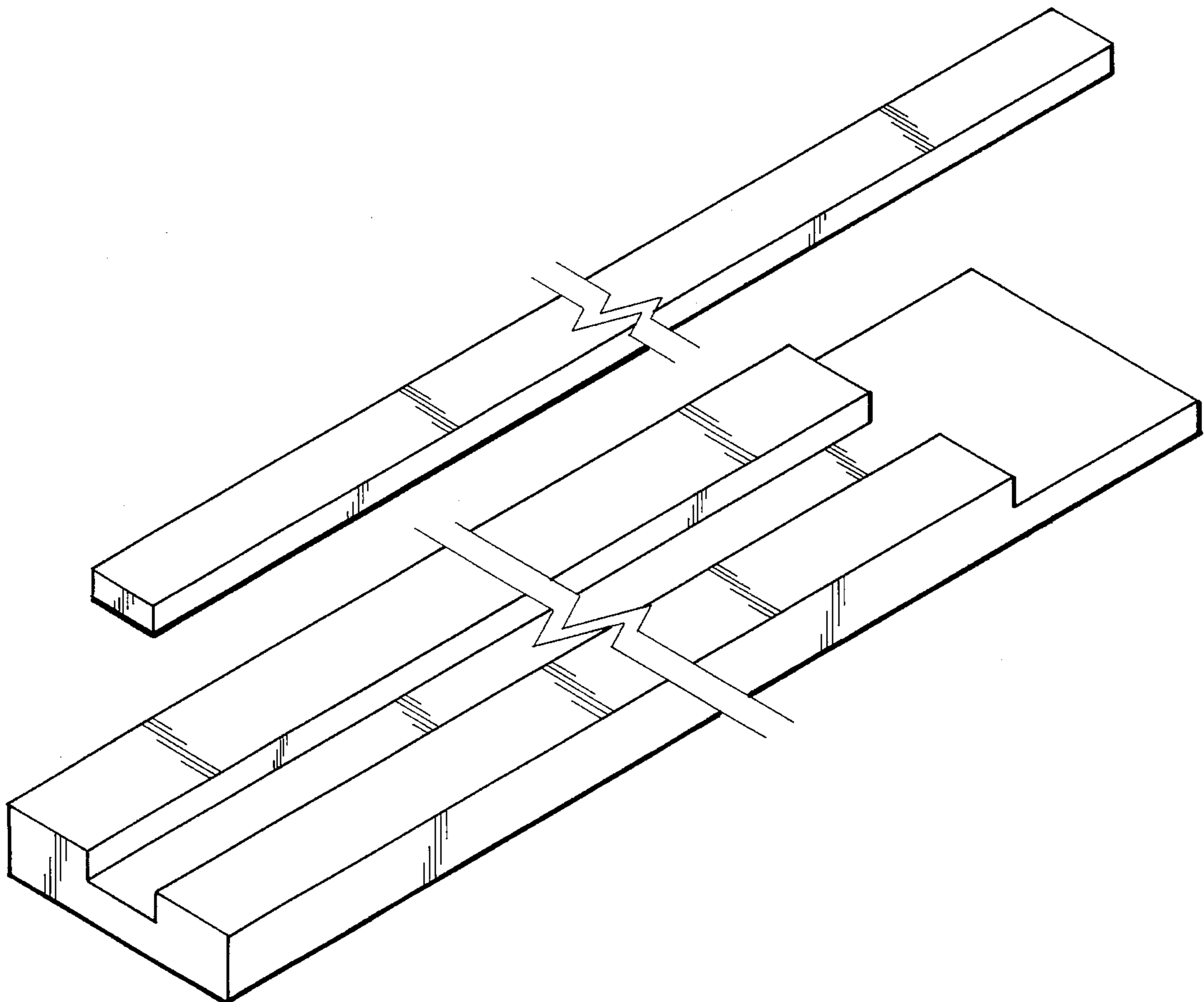

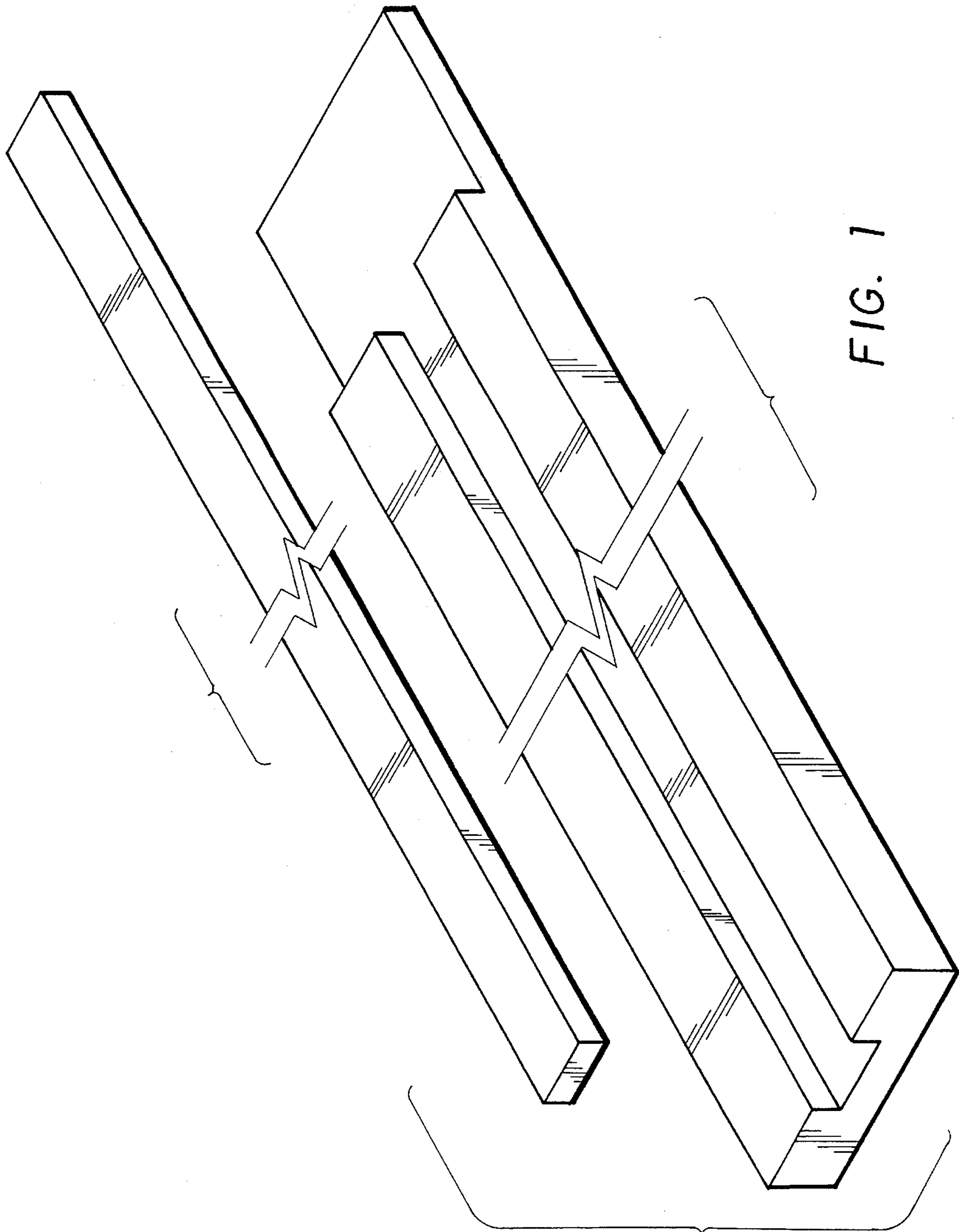

FIG. 1

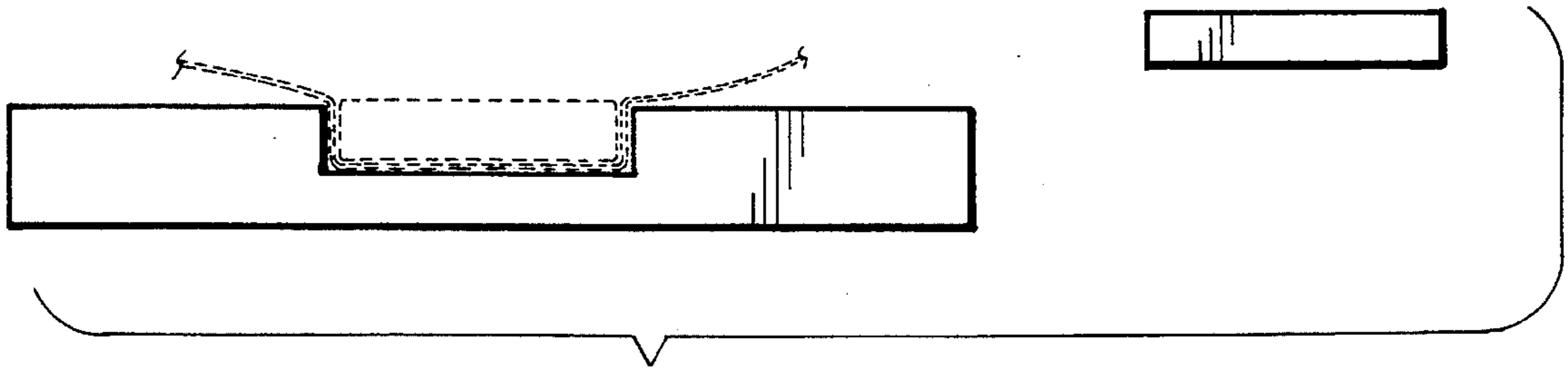

FIG. 2

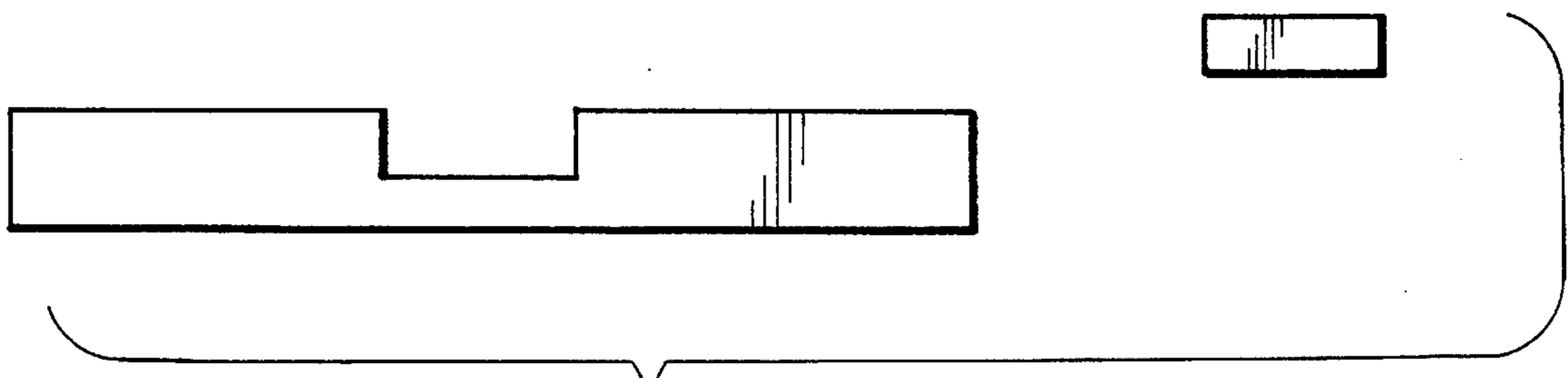

FIG. 3

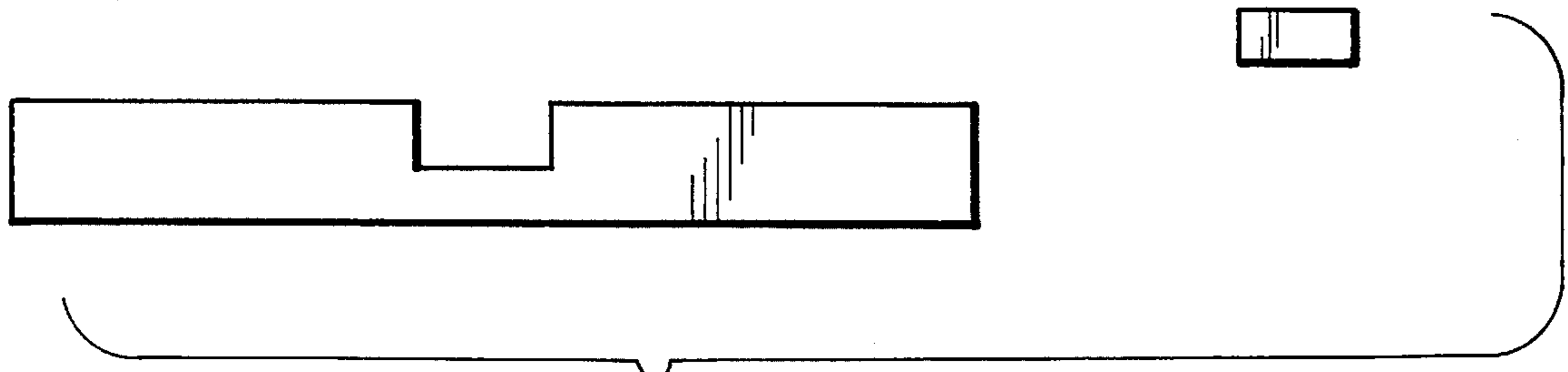

FIG. 4

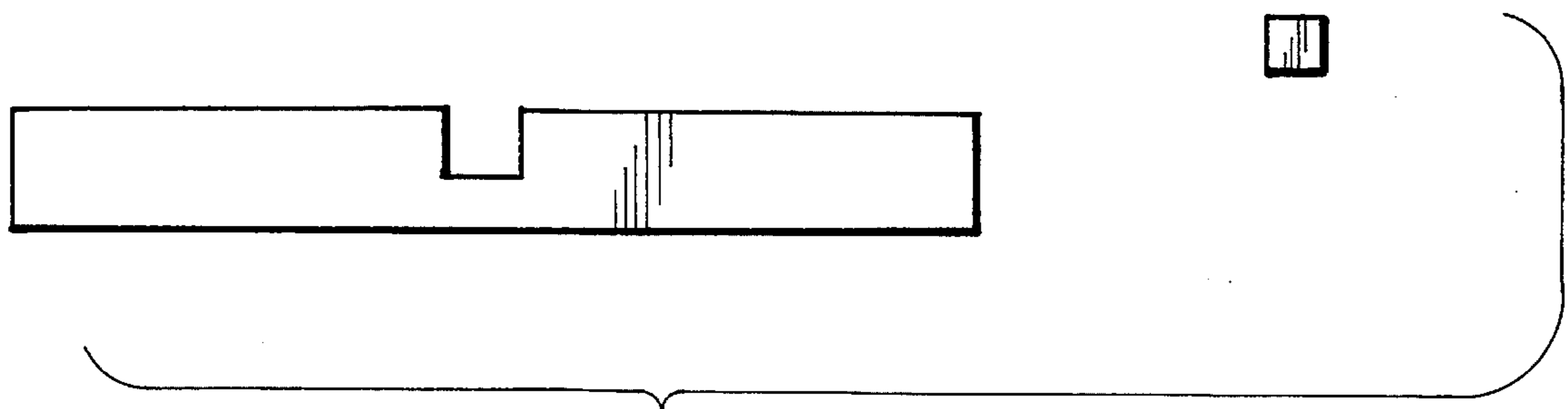

FIG. 5

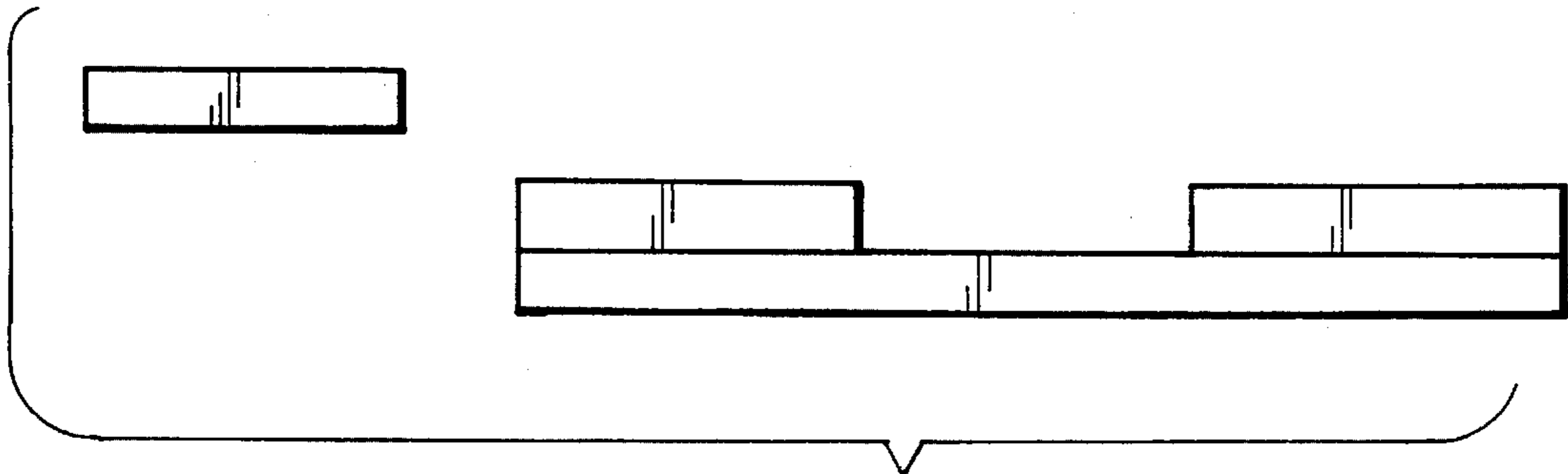

FIG. 6

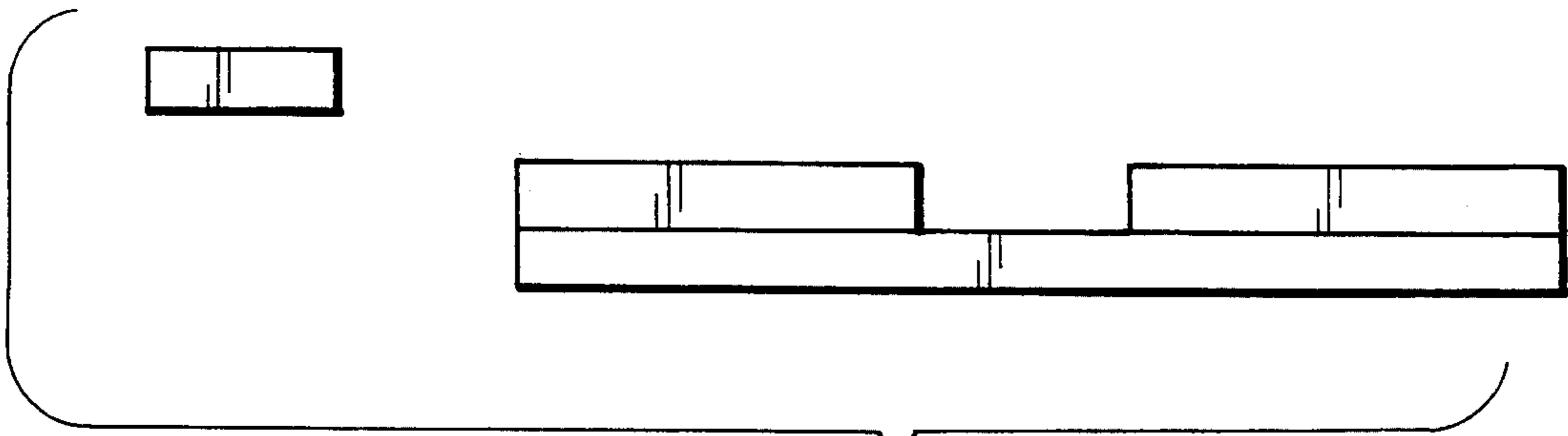

FIG. 7

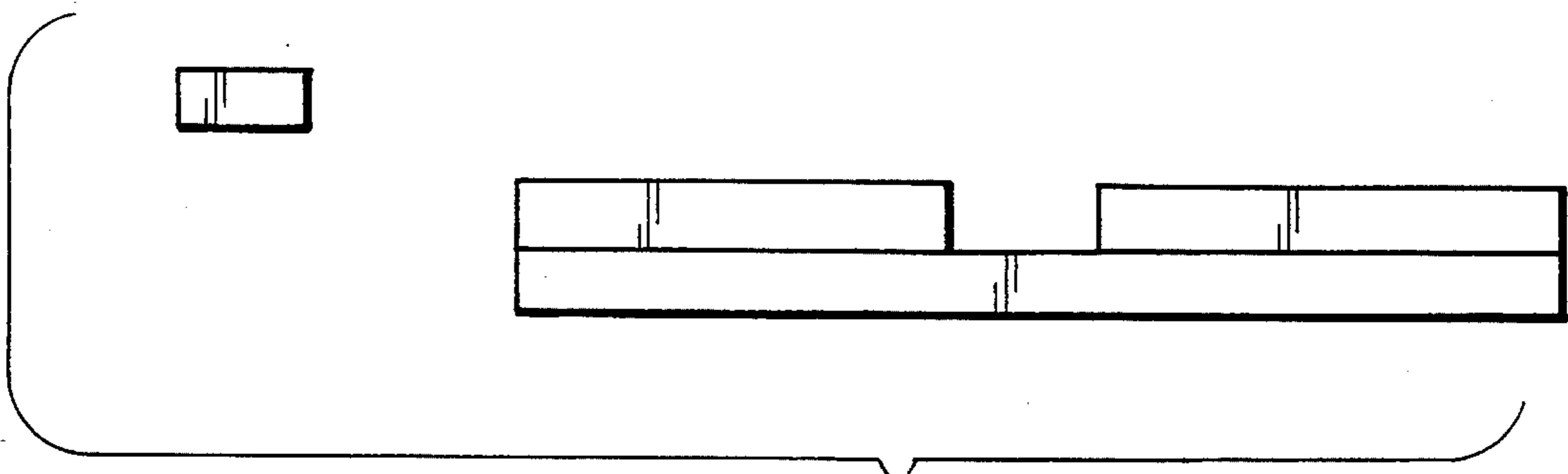

FIG. 8

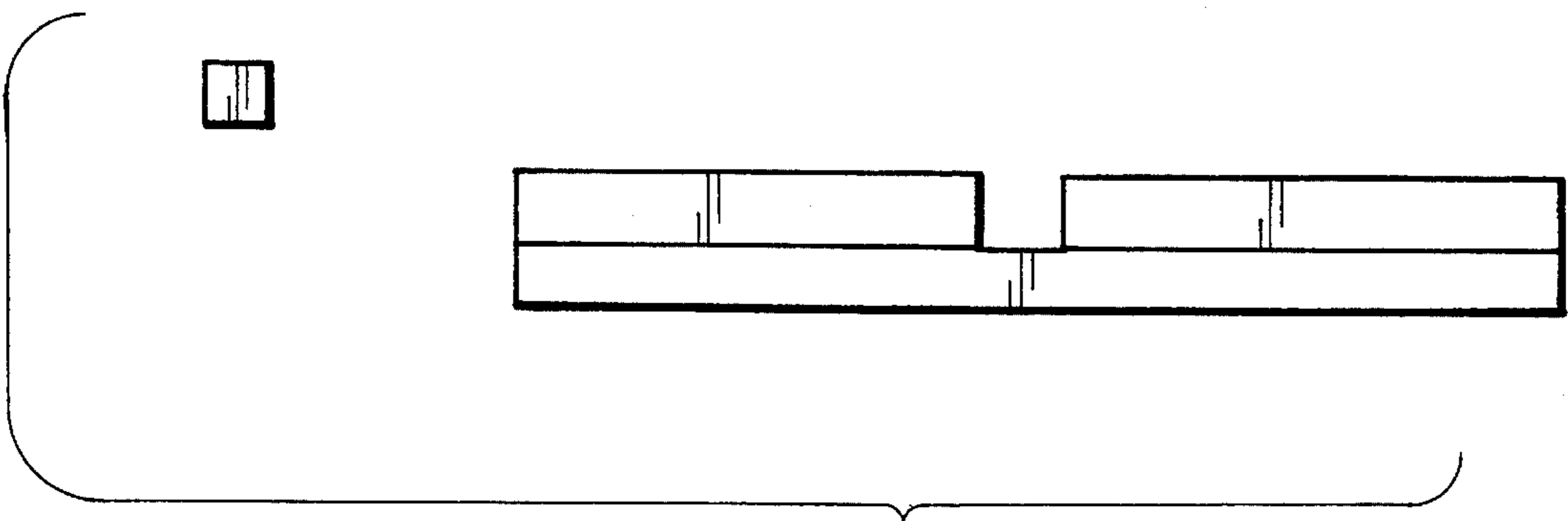

FIG. 9

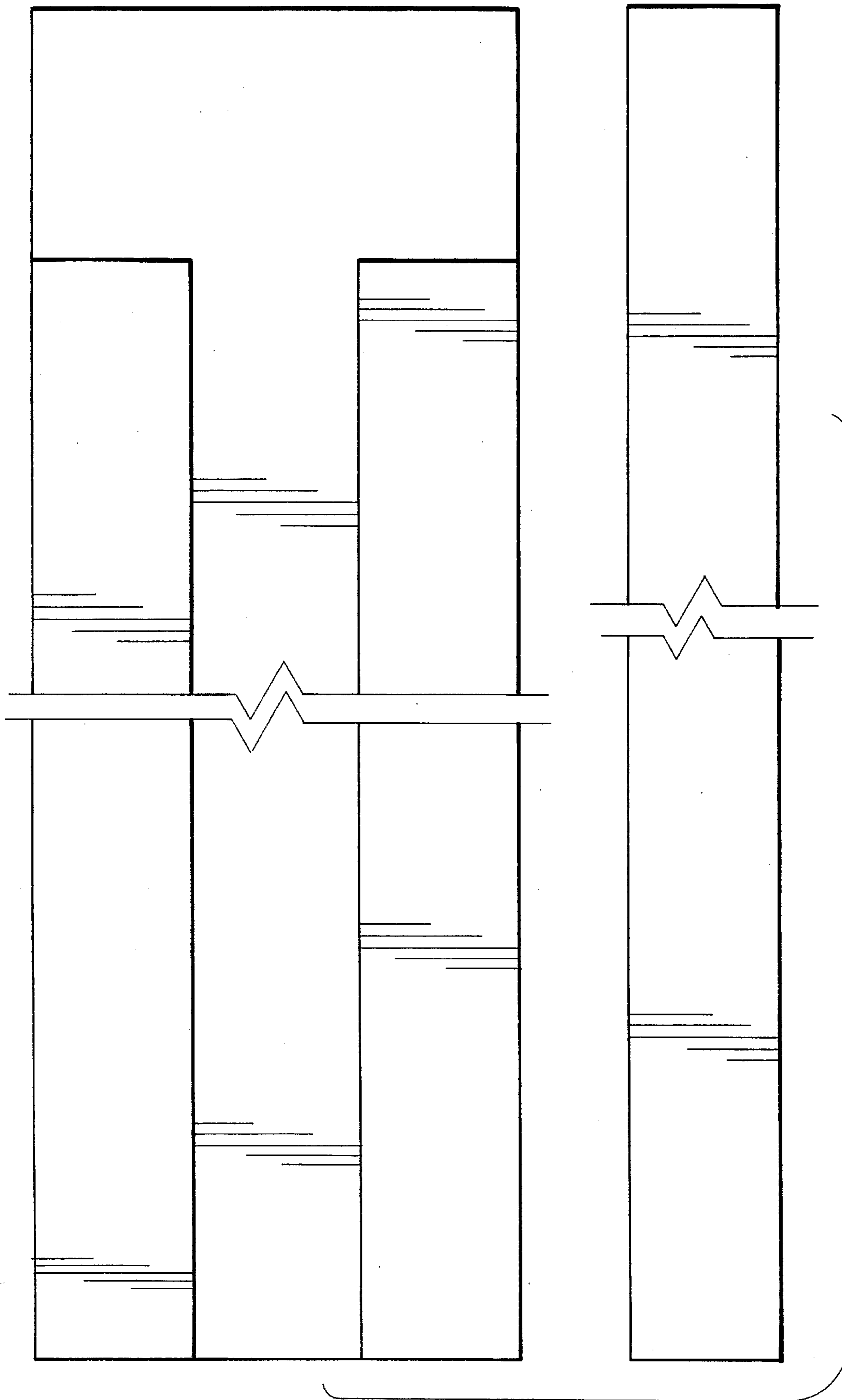

FIG. 10

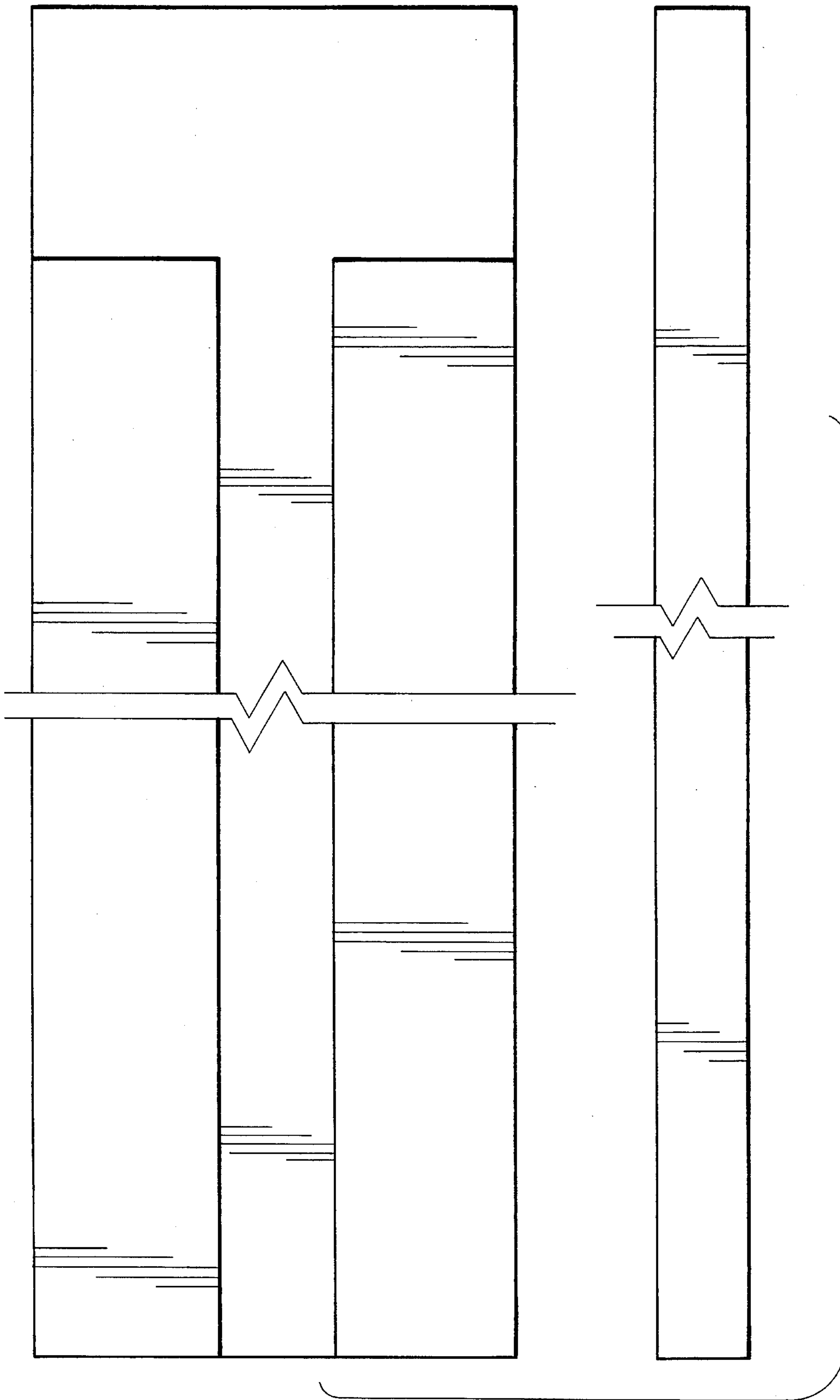

FIG. 17

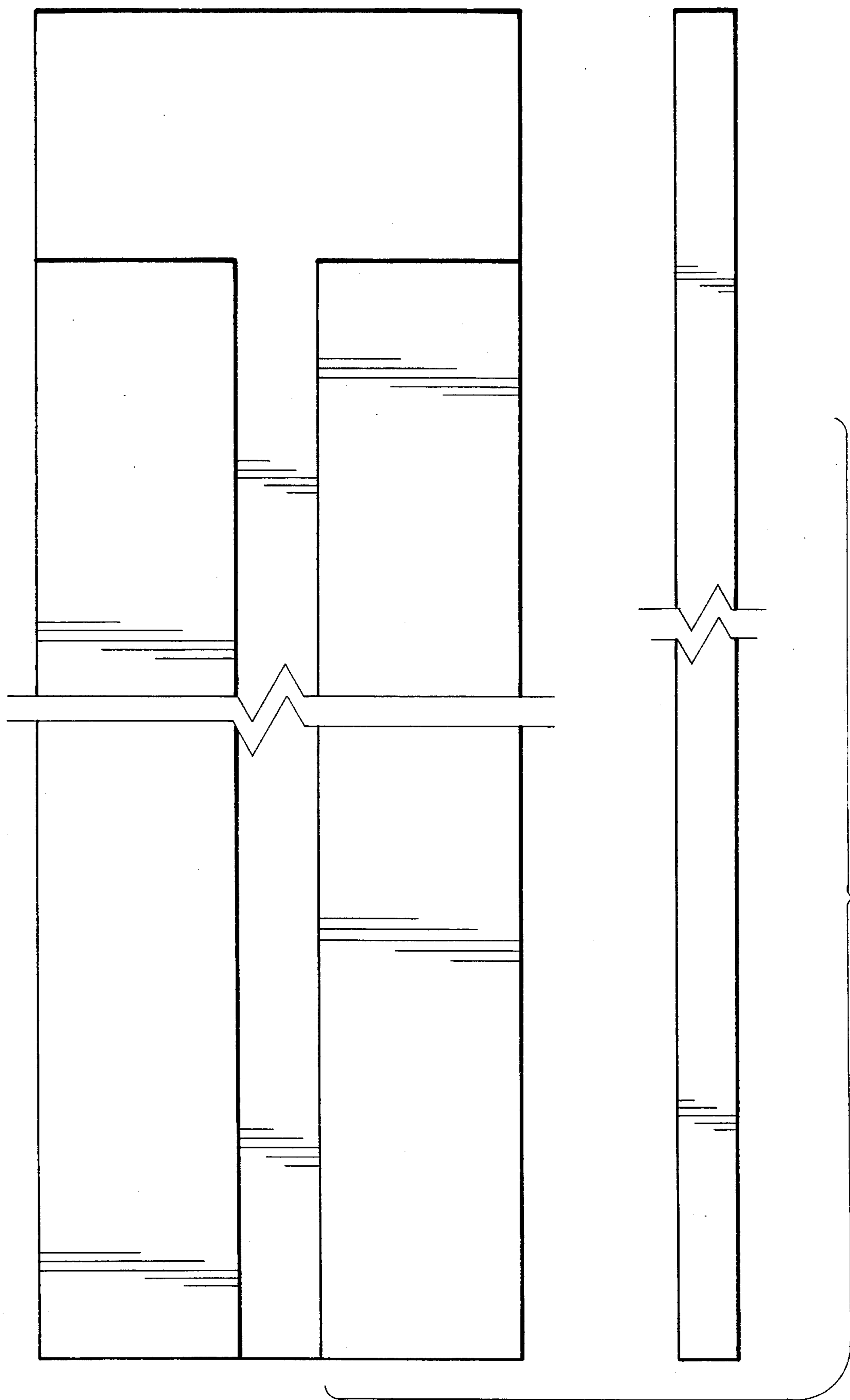

FIG. 12

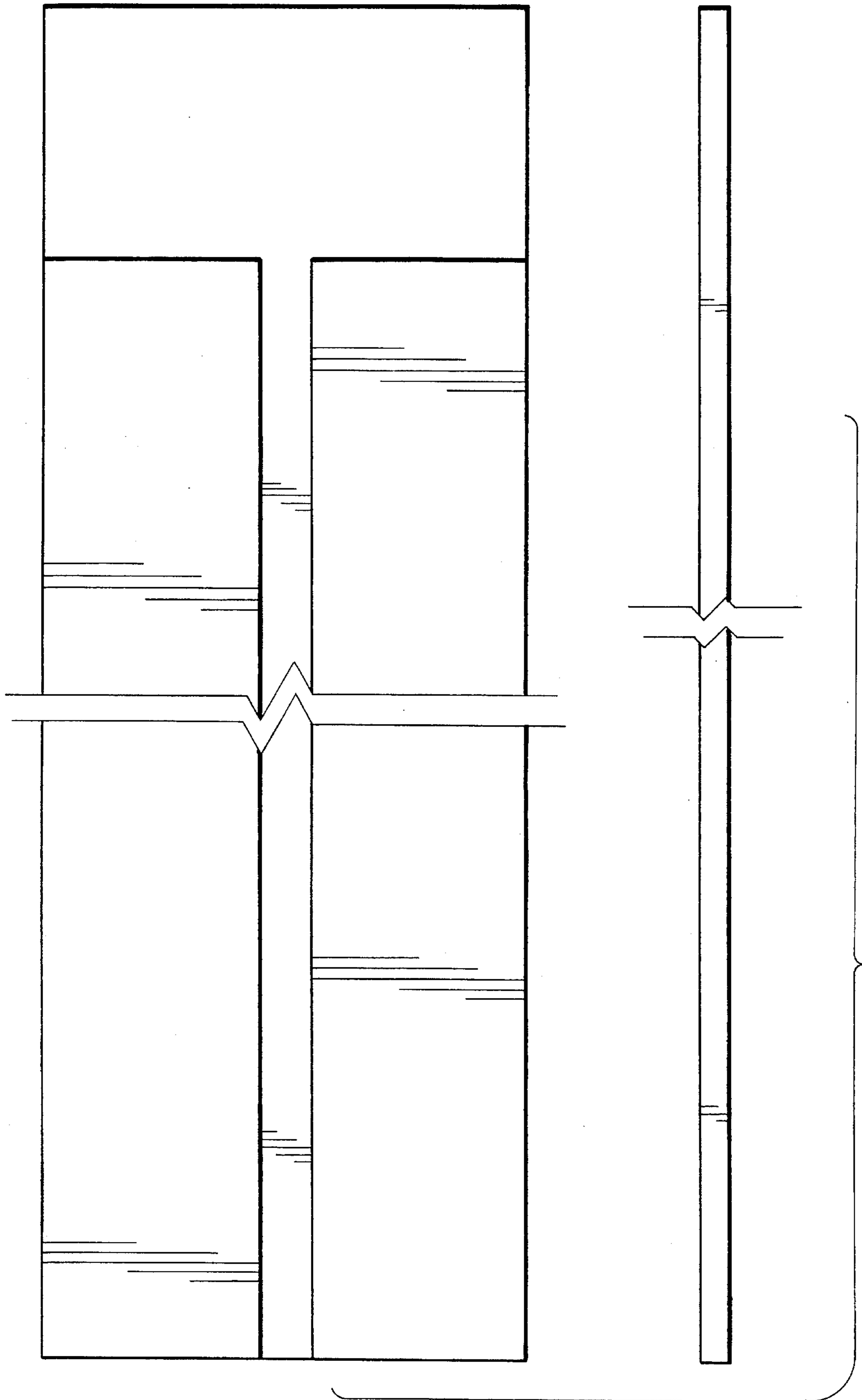

FIG. 13

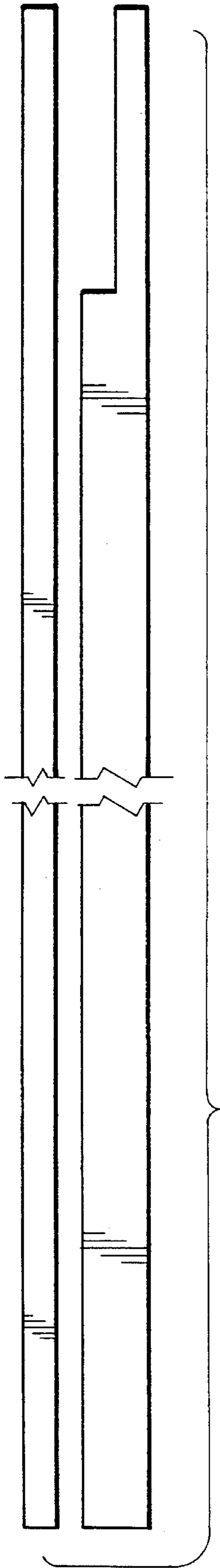

FIG. 14